

This Owner's Manual is provided and hosted by [Appliance Factory Parts](#).



# GE JP385WD Owner's Manual

[Shop genuine replacement parts for GE JP385WD](#)



[Find Your GE Electric Range Parts - Select From 348 Models](#)

----- Manual continues below -----



# Use and Care & Installation Guide

## *“Select-Top” Built-In Modular Downdraft Cooktop*



**Safety Instructions** ..... 4, 5



### **Operating Instructions, Tips**

|                          |        |
|--------------------------|--------|
| Coil Surface Unit Module | 10, 11 |
| Controls                 | 9      |
| Cooktop Comparison       | 8      |
| Cooktop Vent System      | 22     |
| Features                 | 6, 7   |
| Griddle Accessory        | 18–20  |
| Griddle Cooking Guide    | 20     |
| Grill Module             | 14–17  |
| Grill Cooking Guide      | 17     |
| Home Canning Tips        | 21     |
| Radiant Module           | 12–14  |



### **Care and Cleaning** ..... 23–27

|                          |    |
|--------------------------|----|
| Coil Surface Unit Module | 26 |
| Control Panel and Knobs  | 23 |
| Grease Collector Jar     | 23 |
| Griddle Accessory        | 25 |
| Grill Cover              | 25 |
| Grill Module             | 25 |
| Radiant Module           | 27 |
| Vent System              | 24 |



**Problem Solver** ..... 35, 36

More questions?...call  
**GE Answer Center® 800.626.2000**



### **Installation Instructions**

..... 28–34



**Consumer Services** ..... 39

|                          |            |
|--------------------------|------------|
| Important Phone Numbers  | 39         |
| Model and Serial Numbers | 2          |
| Modules and Accessories  | 3          |
| Warranty                 | Back Cover |

|                |              |              |              |
|----------------|--------------|--------------|--------------|
| <i>Models:</i> | <i>JP385</i> | <i>JP387</i> | <i>JP389</i> |
|----------------|--------------|--------------|--------------|



## HELP US HELP YOU...

### **Before using your cooktop, read this guide carefully.**

It is intended to help you operate and maintain your new cooktop properly.

Keep it handy for answers to your questions.

If you don't understand something or need more help, call:

**GE Answer Center®**

**800.626.2000**

**24 hours a day, 7 days a week**

### **Write down the model and serial numbers.**

You'll find them on a nameplate underneath the cooktop on the right side of the bottom chamber.

These model and serial numbers are also on the Consumer Product Ownership Registration Card that came with your cooktop. Before sending in this card, please write these numbers here:

---

Model Number

---

Serial Number

Use these numbers in any correspondence or service calls concerning your cooktop.

### **If you received a damaged cooktop...**

Immediately contact the dealer (or builder) that sold you the cooktop.

### **Save time and money.**

### **Before you request service...**

See the Problem Solver in the back of this guide.

It lists causes of minor operating problems that you can correct yourself.

---

## IF YOU NEED SERVICE...

To obtain service, see the Consumer Services page in the back of this guide.

We're proud of our service and want you to be pleased. If for some reason you are not happy with the service you receive, here are three steps to follow for further help.

**FIRST**, contact the people who serviced your appliance. Explain why you are not pleased. In most cases, this will solve the problem.

**NEXT**, if you are still not pleased, write all the details—including your phone number—to:

Manager, Customer Relations

GE Appliances

Appliance Park

Louisville, KY 40225

**FINALLY**, if your problem is still not resolved, write:

Major Appliance Consumer Action Program

20 North Wacker Drive

Chicago, IL 60606

# MODULES AND ACCESSORIES

General Information



A full selection of modules are available for the cooktop. The modules can be interchanged quickly and easily. Each module has an electrical plug which fits into a receptacle in the center of the outside wall of the cooktop. Some modules are inserted and removed differently than others. If your cooktop is connected to 208 volts, you will notice some increase in cooking times.

**See each module section for specific instructions for installing and removing that module.**

**To purchase**, contact your nearest GE Appliances dealer or service center. If you need assistance in finding your nearest GE dealer, contact the GE Answer Center® at 800.626.2000.

Model numbers are listed below.

## Modules and Accessories

### Coil Surface Unit

JXDC41–Brushed Chrome  
JXDC43–  
Black Porcelain Enamel  
JXDC44–

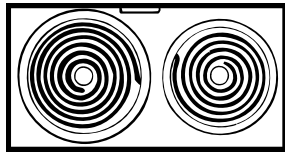

White Porcelain Enamel

This module has one 6" and one 8" coil surface unit. The surface units and drip pans are removable for cleaning.

### Radiant Module

JXDR46VB–Black Radiant  
208V (JP387)

JXDR46VW–White Radiant  
208V (JP387)

JXDR50C–Black Radiant  
240V (JP385, JP389)

Stainless Steel Trim

JXDR50B–Black Radiant and Black Trim  
240V (JP385, JP389)

JXDR50W–White Radiant and White Trim  
240V (JP385, JP389)

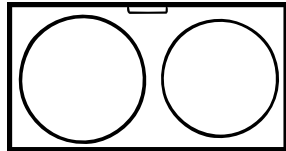

This module has one 5" and one 7" heating coil beneath a smooth glass surface. The two surface units are shown by the outlines on the glass. This module provides fast heat, energy efficient operation and is easy to clean.

### Grill Module

JXDL44 (JP385, JP389)  
JXDL45–208V (JP387)

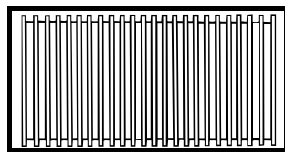

With this module you can char-broil meat indoors all year long. Fat drains away and collects in the grease jar. The grill heating element is divided so the front and back sections can be controlled separately.

### Griddle Accessory

JXDD44



**You must have the grill module to use the griddle accessory.**

The griddle sits directly over the grill heating element and reflector pan. It has two drain holes so fat and meat drippings can drain into the grease jar. The front and back of the griddle are controlled separately.

**WARNING:** Griddle modules JXDD43 and JXDD46 are not to be used with these cooktops.

### Grill Cover

JXDM2–Black  
JXDM3–White



This cover fits over the grill or griddle.



# IMPORTANT SAFETY INSTRUCTIONS

**Read all instructions before using this appliance.**

When using electrical appliances, basic safety precautions should be followed, including the following:

- **Use this cooktop only for its intended use** as described in this use and care guide.
- **Be sure your appliance is properly installed and grounded** by a qualified technician in accordance with the provided installation instructions.
- **Do not assume that you know how to operate all parts of the cooktop.** Some features may work differently from those on your previous cooktop.
- **Do not attempt to repair or replace any part of your cooktop unless it is specifically recommended in this guide.** All other servicing should be referred to a qualified technician.
- **Have the installer show you the location of the circuit breaker or fuse.** Mark it for easy reference.
- **Before performing any service, DISCONNECT THE COOKTOP POWER SUPPLY AT THE HOUSEHOLD DISTRIBUTION PANEL BY REMOVING THE FUSE OR SWITCHING OFF THE CIRCUIT BREAKER.**
- **Do not leave children alone or unattended while the cooktop units are in operation.** They could be seriously burned.
- **Do not allow anyone to climb, stand or hang on the cooktop.**
- **CAUTION: ITEMS OF INTEREST TO CHILDREN SHOULD NOT BE STORED IN CABINETS ABOVE THE COOKTOP— CHILDREN CLIMBING ON THE COOKTOP TO REACH THEM COULD BE SERIOUSLY INJURED.**
- **Never wear loose-fitting or hanging garments while using the cooktop.** Be careful when reaching for items stored over the cooktop. Flammable material could be ignited if brought in contact with hot surfaces and may cause severe burns.
- **Use only dry pot holders**—moist or damp pot holders on hot surfaces may result in burns from steam. Do not let pot holders touch hot surface units. Do not use a towel or other bulky cloths in place of a pot holder.
- **For your safety, never use your appliance for warming or heating the room.**
- **Keep the vent grille and the grease filters clean** to maintain good venting and to avoid grease fires.
- **Do not let cooking grease or other flammable materials accumulate on or near the cooktop.**
- **Do not store flammable materials near the cooktop.** Do not store or use combustible materials, gasoline or other flammable vapors and liquids in the vicinity of this or any other appliance.
- **Do not use water on grease fires. Never pick up a flaming pan.** Turn the surface units off. Smother the flaming pan on a surface unit by covering the pan completely with a well-fitting lid, cookie sheet or flat tray. Use a dry chemical or foam type fire extinguisher.  

Flaming grease outside a pan can be put out by covering with baking soda or, if available, by using a multi-purpose dry chemical or foam type fire extinguisher.
- **Do not heat unopened food containers.** Pressure could buildup and the container could burst causing an injury.
- **Do not touch the surface units.** These surfaces may be hot enough to burn even though they are dark in color. During and after use, do not touch, or let clothing or other flammable materials contact surface units or areas nearby surface units; allow sufficient time for cooling first.  

Potentially hot surfaces include the cooktop, removable modules, accessories and areas facing the cooktop.
- **Cook meat and poultry thoroughly—meat to at least an INTERNAL temperature of 160°F. and poultry to at least an INTERNAL temperature of 180°F.** Cooking to these temperatures usually protects against foodborne illness.
- **Use proper pan size**—Select cookware having flat bottoms large enough to cover the surface unit heating element. The use of undersized cookware will expose a portion of the surface unit to direct contact and may result in ignition of clothing. Proper relationship of cookware to the surface unit will also improve efficiency.
- **Never leave the surface units unattended at high heat settings.** Boilovers cause smoking and greasy spillovers that may catch on fire.
- **Be sure the drip pans (on coil modules only) are not covered and are in place.** Their absence during cooking could damage cooktop parts and wiring.
- **Do not use aluminum foil to line the cooktop tubs, reflector pan, grill or griddle.** Misuse could result in a shock, fire hazard or damage to the cooktop.



- **Only certain types of glass, glass/ceramic, earthenware or other glazed containers are suitable for cooktop service;** others may break because of the sudden change in temperature.
- **Only the grill grate and the griddle accessory plate** may be placed over the grill heating element.
- **To minimize the possibility of burns, ignition of flammable materials and spillage,** the cookware handles should be turned toward the center of the cooktop without extending over the nearby surface units.
- **Keep the tub, the reflector pan, the grill grate and the grease collector jar clean.** Be sure the drain hole in tub is open. If clogged, a fire can occur. Empty the grease jars frequently.
- **Do not immerse or soak the removable coil surface unit module, the solid disk module, the radiant module or the grill heating element. Do not put them in a dishwasher.**
- **Always turn the surface units off** before removing cookware.
- **Never clean the cooktop surface when it is hot.** Some cleaners produce noxious fumes and wet cloths could cause steam burns if used on a hot surface.
- **To avoid possible damage to the cooking surface,** do not apply Cook Top Cleaning Creme to the glass surface when it is hot (on radiant modules only).
- **After cleaning,** use a damp cloth or paper towel to remove all Cook Top Cleaning Creme residue (on radiant modules only).
- **Read and follow all instructions and warnings on Cook Top Cleaning Creme labels** (on radiant modules only).
- **Use care when touching the cooktop.** The glass surface of the cooktop will retain heat after the controls have been turned off (on radiant modules only).
- **Do not operate the radiant surface units if the glass is broken.** Spillovers or cleaning solution may penetrate a broken cooktop and create a risk of electrical shock. Contact a qualified technician immediately should your glass cooktop become broken (on radiant modules only).
- **Avoid scratching the glass cooktop surface.** The cooktop can be scratched with sharp instruments, rings or other jewelry and rivets on clothing (on radiant modules only).
- **Do not stand on the glass cooktop.**
- **Never use the glass cooktop surface as a cutting board (on radiant modules only).**
- **Do not place or store items on top of the glass cooktop surface when it is not in use (on radiant modules only).**
- **Be careful when placing spoons or other stirring utensils on the glass cooktop surface when it is in use.** They may become hot and could cause burns (on radiant modules only).
- **To avoid the possibility of a burn or electric shock,** always be certain that the controls for all surface units are at the off position and all surface units are cool before attempting to remove a coil surface unit or a module.
- **Never leave the kitchen while using the grill or griddle accessory.**
- **Do not replace the grease collector jar with a mayonnaise jar** which could break when hot grease drips into it. Replace with any wide mouth canning jar.
- **Keep an eye on foods being fried at high or medium high heat settings.**
- **Foods for frying should be as dry as possible.** Frost on frozen foods or moisture on fresh foods can cause hot fat to bubble up and over the sides of the pan.
- **Use little fat for effective shallow or deep-fat frying.** Filling the pan too full of fat can cause spillovers when food is added.
- **If a combination of oils or fats will be used in frying,** stir together before heating, or as fats melt slowly.
- **Always heat fat slowly,** and watch as it heats.
- **Never try to move a pan of hot fat especially a deep fat fryer.** Wait until the fat is cool.
- **Use a deep fat thermometer whenever possible** to prevent overheating fat beyond the smoking point.
- **When flaming foods under the hood, turn the fan on.**
- **To control flame-ups,** turn down the heat setting to low rather than off. This keeps the downdraft vent blower on. Or, turn the vent blower to on, then turn the grill off. Use a long-handled utensil to carefully remove the food from the grill. These steps should control the flame until it eventually goes out. If it does not, cover the entire grill module with a cookie sheet or the lid from a large roasting pan. Use a pot holder to remove this later because it will be hot.
- **NEVER USE WATER ON A GREASE FIRE.**

**SAVE THESE INSTRUCTIONS**



# FEATURES OF YOUR COOKTOP

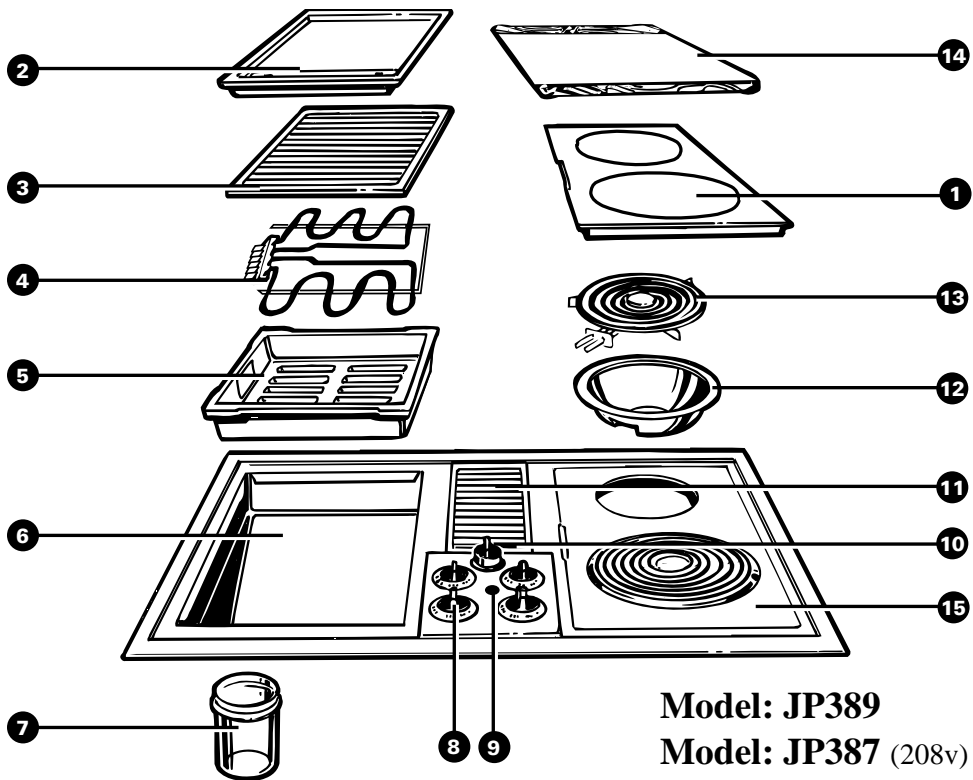
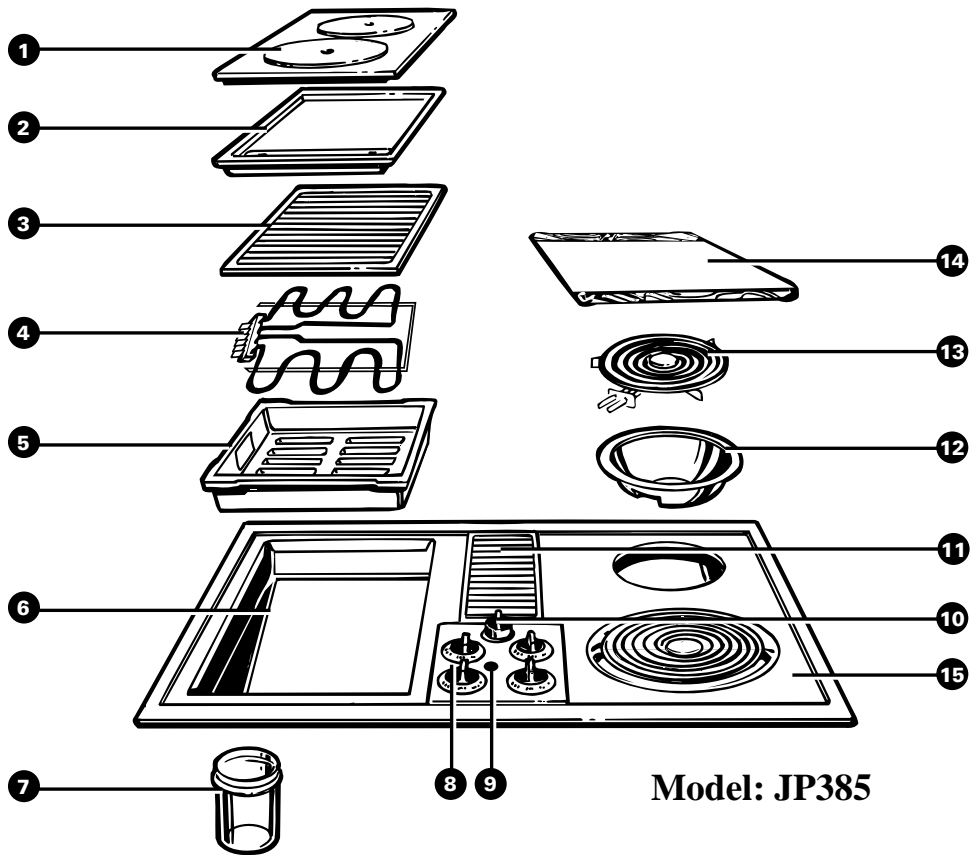



|  |                               |
|--|-------------------------------|
| 1 <b>Radiant Surface Unit Module</b>   | 3, 5, 8,<br>12–14, 27         |
| 2 <b>Griddle Plate Accessory</b><br>Use with the Grill Module heating element and reflector pan.   | 3, 4,<br>18–20,<br>25         |
| 3 <b>Grill Grate</b><br>Part of the Grill Module. Use with the heating element and the reflector pan.  | 4, 14–17,<br>25               |
| 4 <b>Grill Heating Element</b><br>Part of the Grill Module. Use with the grill grate or griddle plate accessory and the reflector pan.                               | 5, 14–17,<br>25               |
| 5 <b>Reflector Pan</b><br>Part of the Grill Module.  | 4,<br>14–17, 25               |
| 6 <b>Cooktop Tub</b><br>Easily cleaned when modules are removed.   | 4, 25                         |
| 7 <b>Grease Collector System</b><br>Uses wide-mouth canning jars to collect grease.  | 5, 14,<br>18, 23              |
| 8 <b>Control Knobs</b><br>Push in and turn to set surface units from LO to HI.   | 9, 15,<br>19, 23              |
| 9 <b>Indicator Light</b><br>Lights when any unit of the cooktop is turned on.  | 9                             |
| 10 <b>Vent Control Knob</b><br>Turn on to exhaust odors, smoke or heat during cooking. The blower automatically comes on when the grill heating unit is turned on.   | 5,<br>22, 23                  |
| 11 <b>Vent System</b><br>The blower vents smoke down and out of the kitchen and house. The vent filter is located under the vent grille and should be cleaned often. | 5, 9,<br>15, 18,<br>22, 24    |
| 12 <b>Drip Pans</b>  | 4, 26                         |
| 13 <b>Coil Surface Units</b><br>May be removed to clean the drip pans. Do not submerge in water.   | 3, 4, 8,<br>10, 11,<br>24, 26 |
| 14 <b>Grill Cover</b>  | 3, 25                         |
| 15 <b>Coil Surface Unit Module</b>   | 3, 4, 8,<br>10, 11<br>21, 26  |







# HOW DOES THIS COOKTOP COMPARE TO YOUR OLD ONE?

Your new modular cooktop may have several types of cooking surface units. You will notice some differences when you use each one.

The best types of cookware to use, plus heat-up and cool-down times, depend upon the type of burner or surface unit you are using.

The following chart will help you to understand the differences among the various cooking surface units and how they differ from others you may have used in the past.

| Type of Cooktop   | Description   | How it Works  |
|---|---|---|
| <b>Radiant (Glass Ceramic) Cooktop</b><br> | Electric coils under a glass-ceramic cooktop.   | Heat travels to the glass surface and then to the cookware, so pans must be flat on the bottom for good cooking results. The glass cooktop stays hot enough to continue cooking after it is turned off. Remove the pan from the surface unit if you want cooking to stop.   |
| <b>Induction</b><br>                       | High frequency induction coils under a glass surface.                                 | Pans must be made of ferrous metals (metal that attracts a magnet). Heat is produced by a magnetic circuit between the coil and the pan. Heats up right away and changes heat settings right away, like a gas cooktop. After turning the control off, the glass cooktop is hot from the heat of the pan, but cooking stops right away.  |
| <b>Electric Coil</b><br>                   | Flattened metal tubing containing electric resistance wire suspended over a drip pan. | Heats by direct contact with the pan and by heating the air under the pan. For best cooking results, use good quality pans. Electric coils are more forgiving of warped pans than radiant or solid disks. Heats up quickly but does not change heat settings as quickly as gas or induction. Electric coils stay hot enough to continue cooking for a short time after they are turned off. |
| <b>Solid Disk</b><br>                    | Solid cast iron disk sealed to the cooktop surface.                                   | Heats by direct contact with the pan, so pans must be flat on the bottom for good cooking results. Heats up and cools down more slowly than electric coils. The disk stays hot enough to continue cooking after it is turned off. Remove the pan from the solid disk if you want the cooking to stop.   |
| <b>Gas Burners</b><br>                   | Regular or sealed gas burners use either LP gas or natural gas.                       | Flames heat the pans directly. Pan flatness is not critical to cooking results, but pans should be well balanced. Gas burners heat the pan right away and change heat settings right away. When you turn the control off, cooking stops right away.   |

## Care of the Modules

**Some of the modules must be cured or preconditioned before using them for the first time.**

**Modules and accessories should be cleaned after each use.** The longer a soil remains, the harder it is to clean. See each module section in this guide for specific instructions. Never immerse any module in water.

**When not in the cooktop, modules and accessories should be stored in a clean, dry place. Always be careful not to drop the modules or they could be damaged.**

## Using the Electric Surface Unit Modules

**You must consider heat up and cool down times for the electric surface units when determining cooking times.** Heat up and cool down times depend on initial temperature settings, the type of cookware used and the amount of food being cooked.

Start cooking at a higher setting to heat the surface unit faster, then turn to a lower setting to finish cooking. **Remember, cooking continues after the surface unit is turned off.**

# CONTROLS



## Surface Cooking With Infinite Heat Controls

At both OFF and HI the control “clicks” into position. You may hear slight “clicking” sounds during cooking, indicating the control is keeping the unit at the heat level you set.

Switching heats to a higher setting always shows a quicker change than switching to a lower setting.

## How to Set the Controls

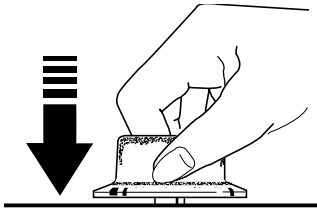

Push the knob in and turn in either direction to the heat setting desired.

Be sure you turn the control to OFF when you finish cooking.

The surface unit indicator light will glow when ANY heat on any module surface unit is on.

## Cooking Guide for Using Heat Settings

**HI**—Used to begin cooking or to bring water to a boil. Reduce heat setting after water boils.

**Medium High**—(Setting halfway between HI and MED.) Maintains a fast boil on large amounts of food.

**MED**—Sauté and brown; keeps food at a medium boil or simmer.

**Medium Low**—(Setting halfway between MED and LO.) Cook after starting at HI; cooks with little water in covered pan.

**LO**—Used for long, slow cooking (simmering) to tenderize and develop flavors. Use this setting to melt butter and chocolate or to keep foods warm.

**NOTE:** The surface unit indicator light may glow between LO and OFF, but there is no power to the surface units.

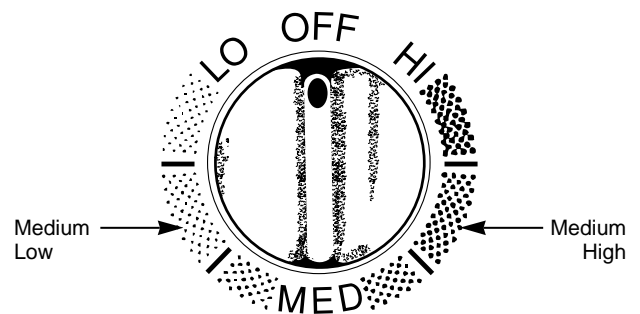

Do not be alarmed by the blower.  
It will automatically come on when the grill or griddle is used.



# COIL SURFACE UNIT MODULE

## How to Insert the Module

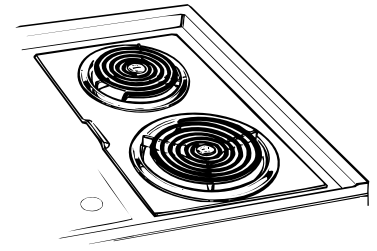
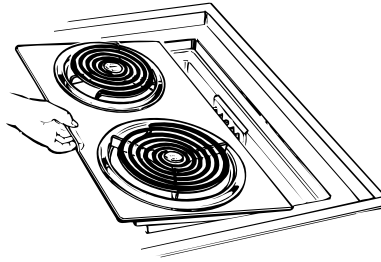
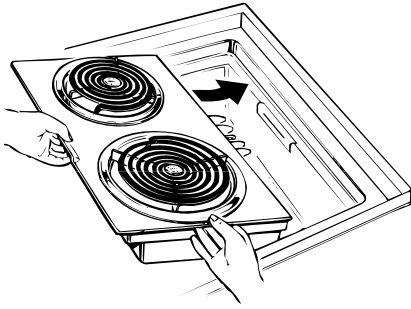

1. Be sure the controls are turned to OFF. To install the module, position the plug to the outside wall of the cooktop.
2. Slide the module toward the outlet in the side of the cooktop until the plug is pushed all the way in.
3. Lower the inside edge of the module into the cooktop until it is flush with the cooking surface.

## How to Remove the Module

1. Be sure the controls are turned to OFF and the surface units are cool before attempting to remove the module.
2. Lift up the tab at the inside edge of the module until the base clears the opening at the side of the cooktop.
3. To unplug, hold the module by the front and back edges and slide toward the center of the cooktop. Lift out when unplugged.
4. If you are storing modules, do not stack them or store other materials on top of them. This could damage the surface of the modules.

## Cookware

Use medium- or heavy-weight cookware. Aluminum cookware conducts heat faster than other metals. Cast-iron and coated cast-iron cookware are slow to absorb heat, but generally cook evenly at low to medium heat settings. Steel pans may cook unevenly if not combined with other metals.

For best cooking results pans should be flat on the bottom. Match the size of the saucepan to the size of the surface unit. The pan should not extend over the edge of the surface unit more than 1 inch.

Always read and follow cookware manufacturer's instructions on cookware use.

**Right**

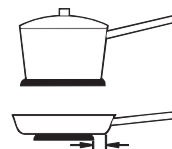

Not over 1 inch

**Wrong**

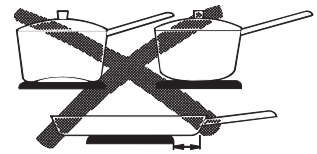

Over 1 inch



## Deep Fat Frying

Do not overfill cookware with fat that may spill over when adding food. Frosty foods bubble vigorously. Watch food frying at high temperatures. Keep cooktop and hood clean from grease.

## Wok Cooking

We recommend that you use only a flat-bottomed wok. They are available at your local retail store.



### Do not use woks that have support rings.

Use of these types of woks, with or without the ring in place can be dangerous. Placing the ring over the

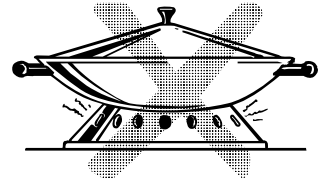

surface unit will cause a build-up of heat that will damage the cooktop. Do not try to use such woks without the ring. You could be seriously burned if the wok tipped over.

## Questions and Answers

### Q. Can I cover my drip pans with foil?

A. No. Clean as recommended in the Care and Cleaning section.

### Q. Can I use special cooking equipment, like an oriental wok, on any surface units?

A. Cookware without flat surfaces is not recommended. The life of the module surface units can be shortened and the cooktop can be damaged from the high heat needed for this type of cooking. A special flat-bottomed wok can be used safely.

### Q. Why am I not getting the heat I need from my surface units even though I have the controls on the correct setting?

A. After turning the surface units off and making sure they are cool, check to make sure that the plug-in units are securely plugged in.

### Q. Why does my cookware tilt when I place it on the surface unit?

A. Because the surface unit is not flat. Make sure the feet of the surface units are sitting on the inside rim of the drip pan and the drip pan is flat on the cooktop surface.

### Q. Why is the porcelain finish on my cookware coming off?

A. If you set the surface unit coil higher than required for the cookware material and leave it, the finish may smoke, crack, pop, or burn depending on the pot or pan.

Also, if you set the surface unit coil higher than required for a long period of time, with small amounts of dry food, you can damage the finish.

### Q. May I can foods and preserves on my coil surface units?

A. Yes, but only use cookware designed for canning purposes. Check the manufacturer's instructions and recipes for preserving foods. Be sure canner is flat-bottomed and fits over the center of the coil surface unit. Since canning generates large amounts of steam, be careful to avoid burns from steam or heat.



# RADIANT MODULE

## How to Insert the Module

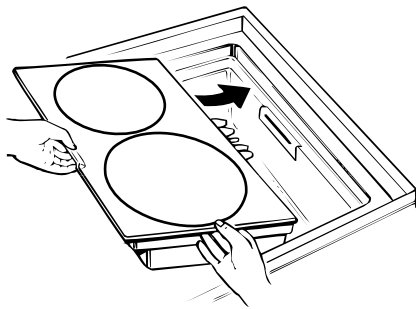

1. Be sure the controls are turned to OFF. To install the module, position the plug to the outside wall of the cooktop.

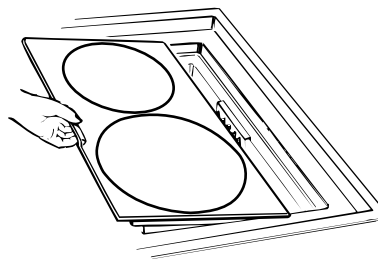

2. Slide the module toward the outlet in the side of the cooktop until the plug is pushed all the way in.

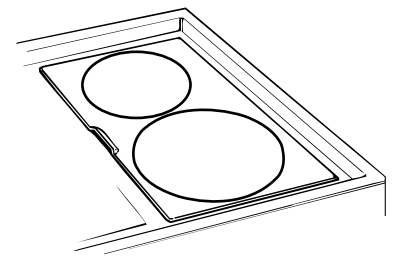

3. Lower the inside edge of the module into the cooktop until it is flush with the cooking surface.

## How to Remove the Module

1. Be sure the controls are turned to OFF and the radiant surface units are cool before attempting to remove the module.
2. Lift up the tab at the inside edge of the module until the base clears the opening at the side of the cooktop.

3. To unplug, hold the module by the front and back edges and slide toward the center of the cooktop. Lift out when unplugged.
4. If you are storing modules, do not stack them or store other materials on top of them. This could damage the surface of the modules.

## General Information About Radiant Modules

The radiant module features heating coils beneath a smooth glass ceramic surface. The two surface units are shown by outlines on the glass.

- When a surface unit is activated, coils beneath the surface unit radiate heat through the glass to the cookware. The red glow of the coils will be instantly visible through the glass. It will take the surface unit a few moments to heat up. The coil cycles on and off to maintain your selected control setting. The coils have temperature limiters to prevent runaway temperatures.
- If you are storing modules, do not stack them or store other materials on top of them, as damage to the glass ceramic surface of the radiant module is likely. Be careful not to damage or bend the electrical plug.
- Do not let pots boil dry. Overheated metal can bond to glass module. An overheated copper pot will leave a residue that will permanently stain the module.
- Sliding aluminum cookware across the glass may leave metal marks. These metal marks will appear as small scratches. They can be removed with the recommended cleaning creme and a razor scraper.
- When a surface unit is turned on, the surface unit can be seen glowing red within a few seconds. The red glow will turn on and off (cycling) to maintain the selected heat setting. With poor cookware, you will see frequent cycling of the unit off and on. Good, flat cookware will minimize the cycling.
- It is safe to place hot cookware from the oven or surface on the glass ceramic surface when the surface is cool.

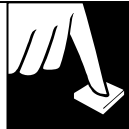

## Types of Cookware

The following information will help you choose cookware which will give good performance.

### **Stainless Steel:** *highly recommended*

Especially good with a sandwich clad bottom. The sandwich bottom combines the benefits of stainless steel (appearance, durability and stability) with the advantages of aluminum or copper (heat conduction, even heat distribution).

### **Aluminum:** *heavy weight recommended*

Good conductivity. Aluminum residues sometimes appear as scratches on the cooktop, but can be removed if cleaned immediately. Because of its low melting point, thin weight aluminum should not be used.

### **Copper Bottom:** *heavy weight recommended*

Good performance, but copper may leave residues which can appear as scratches. The residues can be removed, as long as the cooktop is cleaned immediately.

### **Porcelain/enamel:**

Good performance only with a thick, flat, smooth bottom. Avoid boiling dry, as porcelain can melt and fuse to the surface.

### **Glass-ceramic:** *usable, but not recommended*

Poor performance. May scratch surface.

### **Stoneware:** *usable, but not recommended*

Poor performance. May scratch surface.

### **Cast Iron:** *usable, but not recommended*

Poor performance. May scratch surface.

- We recommend that you use only a flat-bottomed wok. They are available at your local retail store. The bottom of the wok should have the same diameter as the surface unit to insure proper contact.



- Do not use woks that have support rings. This type of wok will not heat on radiant surfaces.

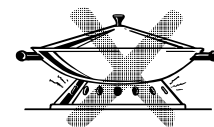

- Some special cooking procedures require specific cookware such as pressure cookers, deep fat fryers, etc. All cookware must have flat bottoms and be the correct size. The cookware should also be covered, if applicable to the cooking process.

## How to Check Pan Performance

Use of correct cookware can affect the cooking performance and cleaning of your cooktop. The correct cookware reduces the temperature of the cooktop surface and minimizes the chance of spillovers burning onto the cooktop.

### **You must use pans with perfectly flat bottoms.**

Some pans may have curved or rounded bottoms or may be warped. If you are unsure of the flatness of your pans you may do this quick test.

Turn your pan upside down on the countertop, place a ruler flat against the pan surface. The bottom of the pan and the straight edge of the ruler should fit flush against each other all the way across. Turn the ruler a full 360 degrees, checking for any space between the ruler and the bottom of the pan.

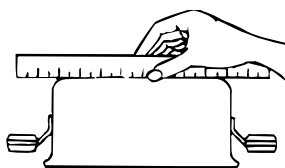

### **Pans with rounded, curved, ridged or warped bottoms are not recommended.**

Another simple test to determine even heat distribution across the cookware bottom is to put one inch of water in the pan. Bring the water to a boil and observe the location of bubbles as the water starts to boil. Good flat cookware will have an even distribution of bubbles over the bottom surface area of the pan. Bubbles localized in only a portion of the bottom indicate uneven contact of the pan to the surface unit, uneven heat transfer or an unsuitable pan.

Use pans that match the diameter of the surface unit. Cooking performance will not be as good if the cookware is either smaller or larger than the surface unit.

(continued next page)



## RADIANT MODULE

(continued)

### CAUTION



- Never cook directly on the glass. Always use cookware.

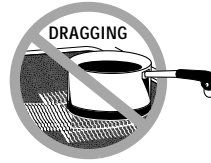

- Do not slide cookware across the cooktop because it can scratch the glass—the glass is **scratch resistant, not scratch proof.**



- Always place the pan in the center of the surface unit you are cooking on.

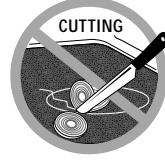

- Do not use the surface as a cutting board.

### Plastic and Sugary Spillovers

**Sugary spillovers** (such as jellies, fudge, candy syrups) or **melted plastics** can cause pitting of the surface of your module (not covered by the warranty) unless the spill is removed while still hot.

**Special care should be taken when removing hot substances.** Follow the instructions in the Care and Cleaning section carefully.

## GRILL MODULE

You can enjoy delicious grilled food year 'round, prepared in the convenience of your own kitchen.

Separate heating elements can be set at different temperatures, allowing you to use half the cooking surface to grill meat and the other half to prepare potatoes or other vegetables, for a complete meal.

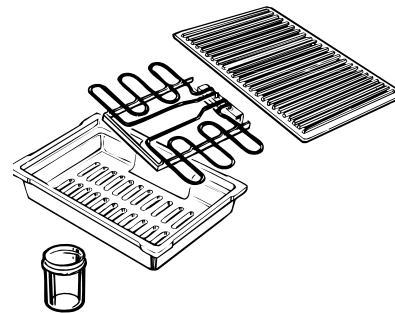

### How to Insert the Grill Module



1. Make sure the grease collector jar is in place beneath the cooktop.

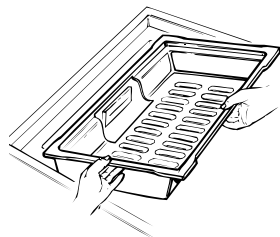

2. Fit the reflector pan in the cooktop. The slots in the pan permit grease to drain into the jar. Keep the slots open at all times.

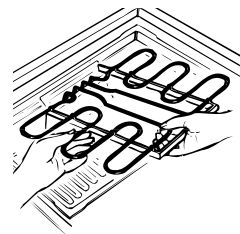

3. Make sure all controls are turned to OFF. Hold the heating element with the plug facing the side of the cooktop and level with the surface. Insert the plug into the cooktop outlet as far as it will go. (Do not force.) The heating element support should rest on the ledge of the reflector pan.

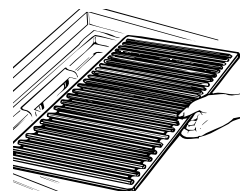

4. Place the grill grate on the reflector pan over the heating element. The grate should be seated properly on the reflector pan.



## Removing the Grill Module

When removing the parts of the grill module to clean, be sure all switches are in the OFF position and the module is cool. Remove the grill grate and then slide the heating element toward the center of the cooktop until it is unplugged. Remove the reflector pan. Empty grease collector jar when cool. Be sure to replace the jar.

## How to Set the Grill Controls

**The control knob must be pushed in to turn;** this prevents the heating element from being turned on accidentally. Push the knob in only when it is in the OFF position. When the knob is in any other position, it can be turned without pushing it in.

**Front and rear sections of the grill heating element are controlled separately.** Heat only half the grill surface for cooking small portions or set each half at a different temperature for cooking different types of foods.

Push in the control knob depending on which side of the cooktop grill module is used. The **right front** and **right rear** control knobs operate the grill when the module is on the right side (on some models). The **left front** and **left rear** control knobs operate the grill when the grill module is on the left side of the cooktop.

## Automatic Blower Operation

The blower comes on automatically when the grill is turned on and turns off automatically when the grill is turned off.

## What to Do If a Flame-Up Occurs

Grilling fat or juicy foods may cause flame-ups. You should never leave the kitchen while using the grill. It's important to control flame-ups so they do not get out of hand.

### TO CONTROL FLAME-UPS

Turn down the heat setting to LO rather than OFF. This keeps the downdraft vent blower on. Or, turn the vent to ON, then turn the grill OFF.

Using a long-handled utensil, carefully remove the food from the grill.

These steps should control the flame until it eventually goes out. If it does not, cover the entire grill module with a cookie sheet or the lid from a large roasting pan. Use a pot holder to remove this later because it will be hot.

**Never use water on a grease fire.** Water will spread the flames.

**NOTE:** It is recommended that you have a dry chemical, foam or Halon type fire extinguisher where you can easily reach it in case of a cooking fire.

*(continued next page)*



# GRILL MODULE

(continued)

## Grill Tips

- **Do not leave the grill unattended while in use.**
- Be sure to preheat according to the cooking guide.
- Make sure the grease collector jar and the reflector pan are clean and in place before using the grill.
- Remove grease from the grease collector jar after each use to avoid spillovers.
- The grates should be oiled or sprayed with a non-stick coating before cooking to prevent sticking. Remove the grate before spraying, and spray only while cool. Spraying directly onto a hot grill may cause a fire.
- Trim fat from meats before placing on the grill. This will reduce smoking and lessen grease buildup in the grease collector jar.
- When cooking foods of various sizes and thicknesses, start larger or thicker pieces first, and quicker-cooking, smaller pieces later. Press meat lightly to lie flat on the grill: slash the fat on the edges of steaks and chops to prevent curling; break the joints of split chickens so they will lie flat.
- Allow space between foods when placing them on the grill. Air needs to circulate around the food for best cooking results.
- Occasionally rearrange foods on the grill, to prevent sticking and provide better browning.
- Season meats after cooking rather than before—salt can draw out juices and dry out meat. Use tongs to turn and rearrange meats on the grill; forks will pierce the meat and release juices.
- If your house has low voltage, foods may be lighter brown than expected. A longer preheating and grill time may be necessary to achieve the desired results.
- The blower comes on automatically when the grill is turned on and turns off automatically when the grill is turned off.

## Questions and Answers

**Q. I followed the cooking times suggested in the Grill Cooking Guide but my foods were not done properly. Is there something wrong with my grill?**

**A.** Probably not. Suggested cooking times should be used only as a general guide. Variables in food can change cooking times required.

**Q. How can I keep barbecued meats from developing an unattractive burned look and taste?**

**A.** Sauces containing sugar will often burn if used during the entire cooking time. If your favorite sauce contains sugar, try adding it only during the last 15 to 20 minutes of cooking time for best results.

**Q. Foods cooked on my grill are not browning as much as I would like. What could cause this?**

**A.** A longer preheating and grill time may be necessary to achieve the desired results.

**Q. Can my grill be switched to the other side of the cooktop where it would be more convenient for me?**

**A.** Your interchangeable cooktop modules can be used on either the right or the left side of the cooktop (on some models). When inserting or removing a module, take care not to force the connection or exert undue pressure which could damage the electrical contacts.

**Q. When cooking many individual foods, what can I do to insure that foods will cook evenly?**

**A.** When cooking foods of various sizes and thicknesses, start larger or thicker pieces first and add quicker-cooking, smaller pieces later. Press the meat lightly to lie flat on the grill. Slash the fat on the edges of steaks and chops to prevent curling. Break the joints of split chickens so they will lie flat.

**Q. My grilled meats sometimes come out drier than they should. What can I do to help prevent this?**

**A.** Season meats after cooking rather than before—salt can draw out juices and dry out meat. Use tongs to turn and rearrange meats on the grill; forks will pierce the meat and release juices.

# GRILL COOKING GUIDE



**Do not leave cooktop unattended during “preheat” (knobs turned to HI) or any time the knobs are turned to HI with food on the grill.**

1. Preheat 5 minutes before grilling. Refer to the setting in the guide for a particular food.
2. Trim excess fat from the meat.
3. Before cooking steaks, slash fat around edges to prevent curling of meat.
4. Suggested cooking times should be used only as a guide, since variables in food can change cooking times.

| Food  | Suggested Setting            | Cook Time   | Comments  |
|---|------------------------------|---|---|
| <b>Steak</b><br>3/4 inch–1¼ inch thick              | Rare: HI<br>Medium:<br>Well: | 5–7 minutes per side<br>6–8 minutes per side<br>8–10 minutes per side     | Preheat grill 10 minutes for rare.  |
| <b>Steak</b><br>1½ inch–2 inches thick              | Rare: HI<br>Medium:<br>Well: | 9–11 minutes per side<br>13–15 minutes per side<br>20–23 minutes per side | Preheat grill 10 minutes for rare. Reduce to MED for well done.   |
| <b>Ground Steak or Hamburgers</b><br>3/4 inch thick | Rare: HI<br>Medium:<br>Well: | 6–8 minutes per side<br>8–10 minutes per side<br>11–12 minutes per side   | Preheat grill 10 minutes for rare.  |
| <b>Chicken</b>                                      | Cut-Up Pieces:               | 45–60 minutes (total)   | Turn over frequently and if desired baste with sauce last 10 to 15 minutes.   |
|   | Quarters:                    | 1 hr. to 1 hr. 10 minutes (total)   | Break joint bones. Place skin side down. Turn over every 15 minutes and baste frequently as desired. Wing-breast quarters take longer than thigh-leg quarters.  |
|   | Halves:                      | 1 hr. to 1 hr. 25 minutes (total)   | Break joint bones. Place skin side down on preheated grill. Turn over and baste frequently as desired.  |
| <b>Ham Slices</b><br>(Precooked) 1 inch thick       |                              | MED<br>10 minutes per side  |   |
| <b>Hot Dogs</b>                                     |                              | HI<br>8–9 minutes (total)   | Turn frequently.  |
| <b>Pork Chops</b>                                   |                              | MED<br>15–18 minutes per side   |   |
| <b>Spare Ribs</b>                                   |                              | MED<br>40–50 minutes (total)  | Boil 5 minutes before grilling. Rearrange and turn over frequently. Baste with sauce last 10 minutes as desired. Very meaty ribs may take about 10 minutes longer.  |
| <b>Lamb Chops</b>                                   |                              | MED<br>20–22 minutes per side   |   |
| <b>Lobster Tails</b>                                |                              | MED<br>15–20 minutes per side   | With a sharp knife or scissors, cut the under shell lengthwise into the meat almost through to outer shell. Spread tail apart to expose meat while grilling. Loosen meat but leave in shell. Spray grates with non-stick coating before preheating. |
| <b>Salmon Steaks</b><br>1 inch thick                |                              | MED<br>8–10 minutes per side  | Brush with melted butter.   |
| <b>Large Sausage Links</b>                          |                              | MED<br>10–12 minutes per side   | Use bratwurst, kielbasa or smoked Polish sausage.   |



## GRIDDLE ACCESSORY

**You must have the grill module to use the griddle accessory.**

Your non-stick coated griddle provides an extra-large cooking surface for meats, pancakes, or other food usually prepared in a frying pan or electric skillet.

**WARNING:** Do not use griddle modules JXDD43 or JXDD46 with these cooktops.

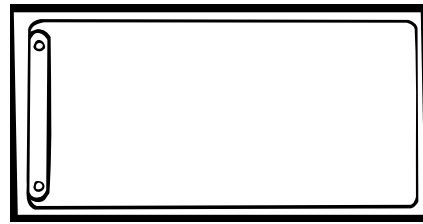

### How to Insert the Griddle Accessory and the Grill Module



1. Make sure the grease collector jar is in place beneath the cooktop.

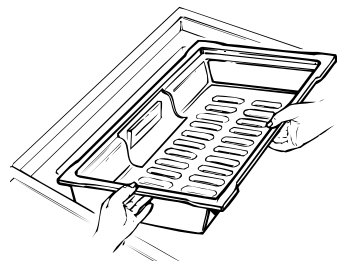

2. Fit the reflector pan in the cooktop. The slots in the pan permit grease to drain into the jar. Keep the slots open at all times.

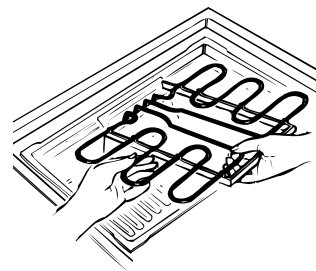

3. Make sure all controls are turned to OFF. Hold the heating element with the plug facing the side of the cooktop and level with the surface. Insert the plug into the cooktop outlet as far as it will go. (Do not force.) The heating element support should rest on the ledge of the reflector pan.

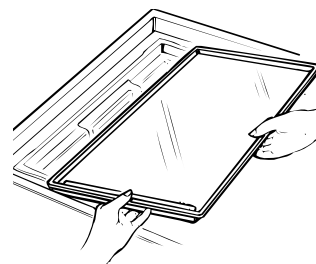

4. Place the griddle plate on the reflector pan over the heating element. The plate should be seated properly on the reflector pan with the griddle's drain holes at the front.

### Removing the Griddle Module

When removing the parts of the grill module to clean, be sure all switches are in the OFF position and the module is cool. Remove the griddle plate and then slide the heating element toward the center of the cooktop until it is unplugged. Remove the reflector pan. Empty grease collector jar when cool. Be sure to replace the jar.

### Using the Griddle

**The non-stick griddle must be preconditioned before using it for the first time.** To precondition, first wash the griddle in soap and water and dry. Then use a paper towel to apply a small amount of cooking oil to the griddle. Remove excess oil with a clean paper towel.

Preheat the griddle as recommended in the Griddle Cooking Guide. After preheating for the recommended amount of time, apply a small amount of oil or butter.

**Do not overheat the griddle.** Leaving the griddle at HI for more than 5 minutes without food can damage the non-stick coating.

Because the heating element under the griddle is divided, you can vary the temperature of the front and rear sections.



## How to Set The Griddle Controls

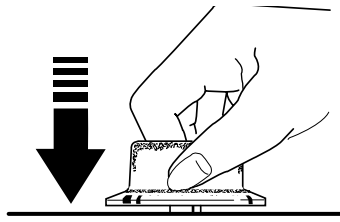

**The control knob must be pushed in to turn;** this prevents the heating element from being turned on accidentally. Push the knob in only when it is in the OFF position. When the knob is in any other position, it can be turned without pushing it in.

**Front and rear sections of the griddle heating element are controlled separately.** Heat only half the griddle surface for cooking small portions or set each half at a different temperature for cooking different types of foods.

Push in the control knob depending on which side of the cooktop griddle module is used. The **right front** and **right rear** control knobs operate the griddle when the module is on the right side (on some models).

The **left front** and **left rear** control knobs operate the griddle when the griddle module is on the left side of the cooktop.

## Automatic Blower Operation

The blower comes on automatically when the griddle is turned on and turns off automatically when the griddle is turned off.

## Griddle Tips

- Most griddled foods require cooking on a preheated surface, which may be greased lightly before adding food. Preheat griddle for only 5 minutes at HI setting, then switch to recommended cook setting.
- If your house has low voltage, foods may be lighter brown than expected. A longer preheating and griddle time may be needed to get good cooking results.
- Make sure the griddle is clean.
- Check the grease collector jar and empty if necessary to avoid spillovers.
- To avoid damaging the non-stick finish, store the griddle upright on edge, if possible. If it is necessary to store it flat, avoid placing other pans or utensils on top.
- Foods which are high in natural fat, such as bacon or sausage, may be started on a cold griddle.
- Avoid using metal utensils with sharp points or rough or sharp edges which might damage the non-stick coated griddle surface. Do not cut foods on the griddle.
- Foods to be warmed may be placed directly on the griddle; a high domed metal cover, such as an inverted kettle, placed over them will help store the heat.
- Condition or “season” the griddle before first-time use.

*(continued next page)*



# GRIDDLE ACCESSORY

(continued)

## Questions and Answers

**Q. Can my griddle be switched to the other side of the cooktop where it would be more convenient for me?**

**A.** Your interchangeable cooktop modules can be used on either the right or left side of the cooktop (on some models). When inserting or removing a module, take care not to force the connection or exert undue pressure which could damage the electrical contacts.

**Q. Can prolonged periods of high heat damage my griddle's surface?**

**A.** A brief preheating period is often necessary for best results with many foods, but leaving the griddle on HI heat setting for more than 5 minutes without food can damage the non-stick coating. Always be sure to turn control knobs to OFF when cooking is completed.

**Q. Why aren't my foods done even though they have cooked the full time?**

**A.** Preheat the griddle for a longer time and leave foods on the griddle longer to attain the desired degree of browning.

**Q. Do I need special cookware for use with my griddle?**

**A.** Avoid using metal cookware with sharp points or rough or sharp edges which might damage the non-stick coated griddle surface. Do not cut foods on the griddle. Use only heat-resistant dishes when foods in containers are to be warmed on the griddle. For further information on caring for your griddle's surface, see the Care and Cleaning section.

**Q. How should I store my griddle when it is not in use?**

**A.** To avoid marring the non-stick finish, store the griddle upright on the edge with the terminals up to avoid damage. If it is necessary to store it flat, avoid placing other pans or cookware on top.

**Q. How long can foods be kept warm with the griddle without losing their appeal?**

**A.** No longer than 2 hours is recommended, to assure good food quality and prevent spoilage. Delicate foods, such as eggs, should not be kept more than 15 to 30 minutes; entrees and casseroles may be warmed for 30 to 60 minutes. Hors d'oeuvres will stay hot for serving up to 1 or 1½ hours. Rearrange or stir food occasionally, if possible.

## GRIDDLE COOKING GUIDE

**Do not leave cooktop unattended during "preheat" (knobs turned to HI) or any time the knobs are turned to HI with food on the griddle.**

Suggested cooking times should be used only as a guide since variables in food may change cooking time. Cooking times may be slightly longer when using the downdraft vent system.

| Food                  | Suggested Setting | Comments                   |
|-----------------------|-------------------|----------------------------|
| Bacon                 | Medium High       |                            |
| Chops                 | Medium High       |                            |
| Cube & Rib Eye Steaks | Medium High       | Grease lightly if desired. |
| Eggs, Fried           | MED               | Grease lightly if desired. |
| Fish Steaks           | Medium High       | Grease lightly if desired. |
| French Toast          | Medium High       | Grease lightly if desired. |
| Ham Slices            | Medium High       | Grease lightly if desired. |
| Hamburgers            | Medium High       |                            |
| Hot Dogs              | Medium High       | Grease lightly if desired. |
| Pancakes              | Medium High       | Grease lightly if desired. |
| Sandwiches            | MED               | Grease lightly if desired. |
| Sausage Patties       | Medium High       |                            |

# HOME CANNING TIPS



## Canning should be done on the Coil Surface Units or the Radiant Units only.

Pots that extend beyond 1 inch of the surface unit are not recommended for most surface cooking. However, when canning with a water-bath or pressure canner, larger-diameter cookware may be used. This is because boiling water temperatures (even under pressure) are not harmful to cooktop surfaces surrounding the surface unit.

HOWEVER, DO NOT USE LARGE DIAMETER CANNERS OR OTHER LARGE DIAMETER POTS FOR FRYING OR BOILING FOODS OTHER THAN WATER. Most syrup or sauce mixtures—and all types of fried foods—cook at temperatures much higher than boiling water. Such temperatures could eventually harm cooktop surfaces surrounding the module surface units.

## Observe Following Points in Canning

1. Be sure the canner fits over the center of the surface unit. If your cooktop or its location does not allow the canner to be centered on the surface unit, use smaller-diameter canners for good canning results or try putting module on opposite side of cooktop (on some models) so the larger unit is in front. Be sure the canner or other large diameter pans do not touch the control knobs or the vent grille. The knobs and the vent grille will be damaged if touched by hot cookware.
2. Flat-bottomed canners must be used. Do not use canners with flanged or rippled bottoms (often found in enamelware) because they don't make enough contact with the surface unit and take a long time to boil water.



**Flat-bottomed canners are recommended for electric coil surface units. They are *required* for glass cooktops.**

3. When canning, use recipes and procedures from reputable sources. Reliable recipes and procedures are available from the manufacturer of your canner; manufacturers of glass jars for canning, such as Ball and Kerr; and the United States Department of Agriculture Extension Service.
4. Remember that canning is a process that generates large amounts of steam. To avoid burns from steam or heat, be careful when canning.

**NOTE:** If your house has low voltage, canning may take longer than expected, even though directions have been carefully followed.

The process time will be shortened by:

- (1) using a pressure canner, and
- (2) starting with **HOT** tap water for fastest heating of large quantities of water.

## CAUTIONS:

**Safe canning requires that harmful microorganisms are destroyed and that the jars are sealed completely.** When canning foods in a water-bath canner, a gentle but steady boil must be maintained continuously for the required time. When canning foods in a pressure canner, the pressure must be maintained continuously for the required time.

After you have adjusted the controls, it is very important to make sure the prescribed boil or pressure levels are maintained for the required time.

### RADIANT GLASS CAUTIONS:

The radiant surface units have temperature limiters that help prevent them from getting too hot. If the bottom of your canner is not flat, the surface unit can overheat, triggering the temperature limiters to turn the unit off for a time. This will stop the boil or reduce the pressure in the canner.

Since you must make sure to process the canning jars for the prescribed time, with no interruption in processing time, you cannot can on radiant surface units if the bottom of your canner is not flat enough.

### What is a Temperature Limiter?

Every radiant surface unit has a Temperature Limiter. The Temperature Limiter protects the glass-ceramic surface from getting too hot.

The Temperature Limiter may turn off the surface units if:

- The pan boils dry.
- The pan bottom is not flat.
- The pan is off center.
- There is no pan on the unit.



# COOKTOP VENT SYSTEM

The blower comes on automatically when the grill or griddle is turned on and turns off automatically when the grill or griddle is turned off.

If the vent is turned on using the knob, the blower will not turn off automatically and must be turned off using the knob.

The built-in vent system helps remove cooking vapors, odors and smoke from foods prepared on the cooktop modules.

---

## How to Operate Vent System

To operate the vent system using the knob, turn the VENT knob on the control panel to ON.

Some models have a control that allows you to choose blower speeds from low to high.

Continuous use of the vent system while cooking helps keep the kitchen comfortable and less humid, reducing cooking odors and soiling moisture that normally creates a frequent need for cleaning.

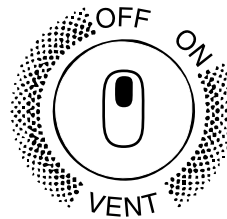

on some models  
JP385

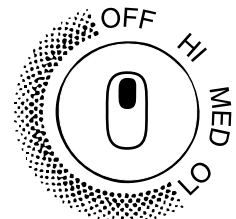

on some models  
JP387  
JP389

# CARE AND CLEANING



**NOTE:** Let cooktop parts cool before touching or handling.

Proper care and cleaning are important so your cooktop will give you efficient and satisfactory service. Follow these directions carefully in caring for your cooktop to assure safe and proper maintenance.

## Porcelain Enamel Finish (on some models)

The porcelain enamel finish is sturdy but breakable if misused. This finish is acid-resistant. However, any acidic foods spilled (such as fruit juices, tomato or vinegar) should not be permitted to remain on the finish.

If acids spill on the cooktop while it is hot, use a dry paper towel or cloth to wipe it up right away. When the surface has cooled, wash with soap and water. Rinse well.

For other spills such as fat splatterings, wash with soap and water after the surface has cooled. Rinse well. Polish with a dry cloth.

## Brushed Chrome Finish (on some models)

Clean the brushed chrome top with warm, soapy water or Bon Ami® brand cleanser and immediately dry it with a clean, soft cloth. Take care to dry the surface following the "grain." To help prevent finger marks after cleaning, spread a thin film of baby oil on the surface. Wipe away excess oil with a clean, soft cloth.

## Grease Collector Jar

Scoop out grease with a large spoon. Soak the jar in warm water to loosen grease if desired. Clean with a plastic or soap-filled scouring pad and hot soapy water.

The jar may also be cleaned in the dishwasher.

The jar may be replaced with any wide-mouth canning jar.



## Control Panel and Knobs

Clean up any spills or spatters with a damp cloth. Remove heavier soil with warm, soapy water.

Clean the control panel with mild liquid dish detergent and a soft cloth. Rub the control panel lightly.

**CAUTION:** Do not use abrasives of any kind on the control panel.

The control knobs may be removed for easier cleaning.

To remove a knob, pull it straight off the stem. Wash the knobs in soap and water but do not soak.

Do not allow water to run down inside the surface of the panel while cleaning. After drying, return the knobs to the cooktop, making sure to match the flat area on the knob to the shaft.

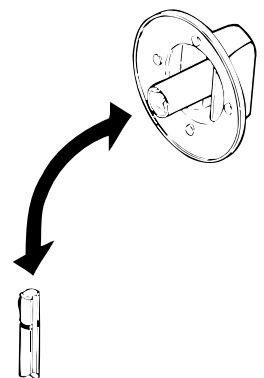

(continued next page)



## CARE AND CLEANING

(continued)

### Cooktop Tub

Wipe out tub with hot soapy water—or a soap-filled or plastic scouring pad. Rinse with a damp cloth. Make sure the drain hole is not blocked. Clean with a cotton swab or toothpick.

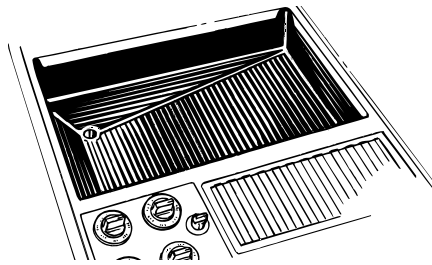

### Vent System

**Before cleaning the vent grille**, be sure exhaust blower is shut off.

**To clean the vent grille**, remove it from the cooktop by lifting it up. Wipe with a damp cloth. If necessary the vent grille can be washed in the sink. Use dishwashing liquid for cleaning.

Do not use abrasive cleaners. They will damage the vent grille's finish.

Do not clean the vent grille in the dishwasher.

**To clean the vent chamber**, use hot, soapy water. Do not use abrasive cleaners. They will damage the finish.

#### Vent Filter

The filter is held in place with a metal latch. Move latch up in either direction and lift filter up and out of the vent opening.

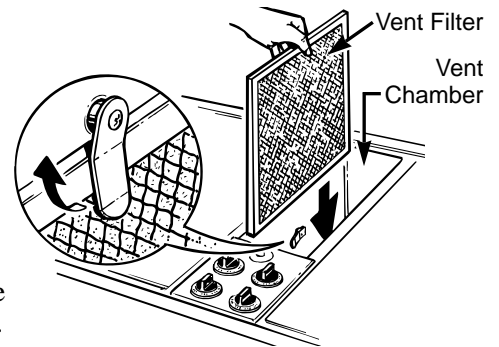

Clean the filter by swishing it in hot, soapy water. Rinse well and dry thoroughly.

**Do not operate the vent without the filter in place.**

### Modules

#### CAUTION

- Be sure all controls are turned OFF before attempting to remove a module or heating element.
- Do not attempt to clean plug-in surface units or grill heating element in an automatic dishwasher.
- Do not immerse plug-in surface units in liquids of any kind.
- Do not bend the plug-in surface unit plug terminals.
- Do not attempt to clean, adjust or in any way repair the plug-in receptacle.

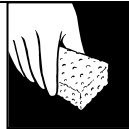

## Grill Module

### To remove:

- Lift off the grill grate.
- Unplug the heating element.

**Do not attempt to clean the heating element.**

### To replace:

- Place the reflector pan in the cooktop tub with the hole for the plug-in towards the outside of the cooktop.
- Plug in the heating element.
- Place the grill or griddle grate on top of the reflector pan.

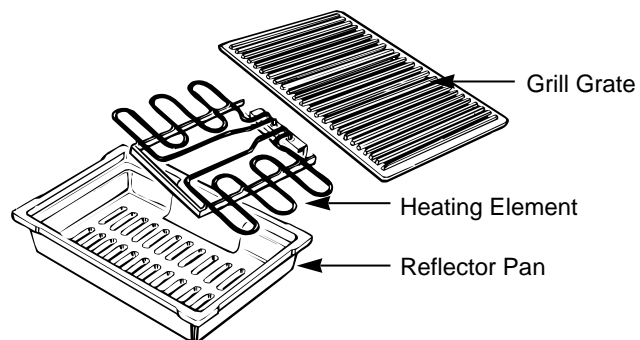

## Grill Grate

Clean with a plastic scouring pad and hot, soapy water. Rinse well. The grill grate may also be cleaned in the dishwasher. Do not clean in a self-cleaning oven.

## Reflector Pan

Let grill or griddle cool, then remove. Lift out the reflector pan. Clean with either a plastic or soap-filled scouring pad and hot, soapy water. The reflector pan may also be cleaned in the dishwasher.

## Griddle Accessory

Clean with a plastic scouring pad and hot, soapy water. Rinse well. Do not use abrasive cleaners.

Do not clean in the dishwasher.

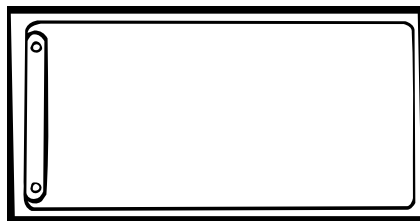

## Grill Cover

**Do not place the cover on a hot module or leave it over the grill while preheating.**

To clean the cover, wash it at the sink with soap and water and dry. For stubborn soil, let it soak for 5 to 10 minutes or use a nylon brush or pad. Do not use a metal scouring pad or other abrasives.

Do not clean in the dishwasher.



*(continued next page)*



# CARE AND CLEANING

(continued)

## Coil Surface Unit Module

**Clean the area surrounding the surface units** according to either the Brushed Chrome or Porcelain section (depending on your model).

**To clean the surface units**, turn the control to the highest setting for a minute. The coils will burn off any soil.

### CAUTION

- **Be sure all controls are turned to OFF and surface units are cool before attempting to remove them.**
- Do not immerse the surface units or the module in liquids of any kind.
- Do not clean the surface units or the module in a dishwasher.
- Do not bend the surface unit plug terminals.
- Do not attempt to clean, adjust or in any way repair the plug-in receptacle.

### To remove a surface unit:

To remove the drip pans for cleaning, the surface units must be removed first.

Lift the surface unit about 1 inch above the drip pan and pull it out.

**Do not lift the surface unit more than 1 inch. If you do, it may not lie flat on the drip pan when you plug it back in.**

**Repeated lifting of the surface unit more than 1 inch above the drip pan can permanently damage the receptacle.**

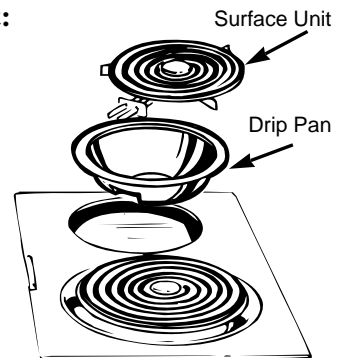

### To replace a surface unit:

- Replace the drip pan into the recess in the cooktop. Make sure the opening in the pan lines up with the receptacle.
- Insert the terminals of the surface unit through the opening in the drip pan and into the receptacle.
- Guide the surface unit into place so it rests evenly.

### Drip Pans

Remove the surface units. Then lift out the drip pans.

**For best results, clean the drip pans by hand.** Place them in a covered container (or a plastic bag) with 1/4 cup ammonia to loosen the soil. Then scrub with a soap-filled scouring pad if necessary. Rinse with clean water and polish with a clean, soft cloth.

The drip pans may also be cleaned in the dishwasher.

**Do not cover the drip pans with foil.**

Using foil so close to the receptacle could cause shock, fire or damage to the cooktop.

**Clean the area under the drip pans often.**

Built-up soil, especially grease, may catch on fire.



## Radiant Module–Glass Ceramic Cooktop Cleaning

Cleaning of glass ceramic cooktops is different from cleaning a standard porcelain finish. To maintain and protect the surface of your new glass ceramic cooktop follow these basic steps.

Before using your module for the first time, clean it with the recommended cleaning creme. This helps protect the top and makes clean-up easier.

**DAILY CLEANING: Use only the recommended cleaning creme on Glass Ceramic.**

### For normal, light soil:

1. Rub a few drops (less is better) of the recommended cleaning creme onto the soiled area using a damp paper towel. Wipe until all soil and creme are removed. Frequent cleaning leaves a protective coating which is essential in preventing scratches and abrasions.
2. Clean the surface with the recommended cleaning creme after each use.

### For heavy, burned-on soil:

1. Apply a few drops of the recommended cleaning creme to the (cool) soiled area.
2. Using a damp paper towel, rub creme into the burned-on area. As with any burned-on spill, this may require some effort.
3. Carefully scrape remaining soil with the razor scraper. Hold the scraper at a 30° angle against the ceramic surface.
4. If any soil remains, repeat the steps listed above. For additional protection, after all soil has been removed, polish the entire surface with the recommended cleaning creme.
5. Buff with a dry paper towel.

### NOTE:

- Using a razor scraper will not damage the surface if the 30° angle is maintained.
- Be sure to use a new, sharp razor scraper. Do not use a dull or nicked blade.
- **Store the razor scraper out of reach of children.**

### Special Care:

**Sugary spillovers** (such as jellies, fudge, candy syrups) or **melted plastics** can cause pitting of the surface of your cooktop (not covered by the warranty) unless the spill is removed while still hot. **Special care should be taken when removing hot substances.** Follow these instructions carefully and remove the soil while the spill is still hot.

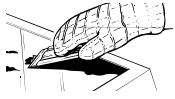
1. Turn off all the surface units affected by the spillover. Remove hot pans.
2. Wearing an oven mitt, hold the razor scraper at a 30° angle to the cooktop and scrape the hot spill to a cool area outside the surface unit. 
3. With the spill in a cool area, use a dry paper towel to remove any excess. Any spillover remaining should be left until the surface of the module has cooled. Do not continue to use the soiled surface unit until all of the spillover has been removed. Follow the steps under heavy, burned-on soil to continue the cleaning process.

### General Information:

As the recommended cleaning creme cleans, it leaves a protective coating on the cooktop surface. This coating helps to prevent build-up of mineral deposits (water spots) and will make future cleaning easier. Dishwashing detergents remove this protective coating and therefore make the cooktop more susceptible to staining.

**To conveniently order more creme and/or scrapers for cleaning your radiant range, please call our toll free number:**

|                              |                     |
|------------------------------|---------------------|
| <b>National Parts Center</b> | <b>800-626-2002</b> |
| Creme 10 oz.                 | # WX10X300          |
| Scraper                      | # WX5X1614          |
| Creme and Scraper Kit        | # WB64X5027         |

## PRECAUTIONS

- Most cleaners contain ammonia, chemicals and abrasives which can damage the surface of your cooktop. **Use only the recommended cleaning creme for proper cleaning and protection of your glass ceramic surface.**
- If you slide **aluminum or copper cookware** across the surface of your cooktop, they may leave **metal markings which appear as scratches.** If this should happen, use the razor scraper and cleaning creme to remove these markings. Failure to remove these residues immediately may leave permanent marks.
- Water stains (mineral deposits) are removable using the recommended cleaning creme or full strength white vinegar.
- If pots with a thin overlay of aluminum, copper, or enamel are allowed to boil dry, the overlay may bond with the glass ceramic and leave a black discoloration. This should be removed immediately before heating again or the discoloration may be permanent.
- Use of window cleaner may leave an iridescent film on the cooktop. The recommended cleaning creme will remove this discoloration.

**Read and follow all instructions and warnings on the recommended cleaning creme label.**

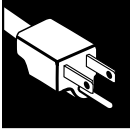

# INSTALLATION INSTRUCTIONS

## Before you begin

Read these instructions completely and carefully.

**Important**—Save these instructions for local inspector's use.

**Important**—Observe all governing codes and ordinances.

**NOTE TO INSTALLER**—Be sure to leave these instructions with the Consumer.

**NOTE:** This appliance must be properly grounded.

**Unless very knowledgeable in the installation of this product, engage a professional installer.**

## Tools You Will Need

- Saw
- Flat blade screwdriver
- Electrician's pliers
- Duct tape
- Measuring tape or scale
- Carpenter's square
- Wrench or socket set
- Drill and drill bit
- Sheet metal screws
- Junction box

**NOTE:** Installation of this unit requires 2 people. Do not attempt to install without assistance.

## Electrical Requirements

**CAUTION: FOR PERSONAL SAFETY, REMOVE HOUSE FUSE OR CIRCUIT BREAKER BEFORE BEGINNING INSTALLATION.**

This appliance must be supplied with the proper voltage and frequency, as listed in these Installation Instructions, and connected to an individual, properly grounded branch circuit, protected by a circuit breaker or time delay fuse. Proper electrical ratings should be verified with listing on product's rating plate. The rating plate is located on the right-hand side of the exhaust plenum.

All wire connections must be made in accordance with local codes and properly insulated. Check with your local utility for governing electrical codes and ordinances. In the absence of local electrical codes, the National Electrical Code, ANSI/NFPA No. 70—Latest Edition, governing electric range installations, must be followed.

A copy of the National Electrical Code can be obtained by writing to:

National Fire Protection Association  
Batterymarch Park  
Quincy, MA 02260

## 30" Cooktop (Dimensions for reference only)

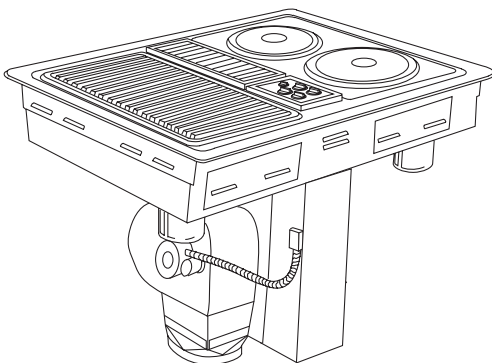

Unit must be vented to the outside!

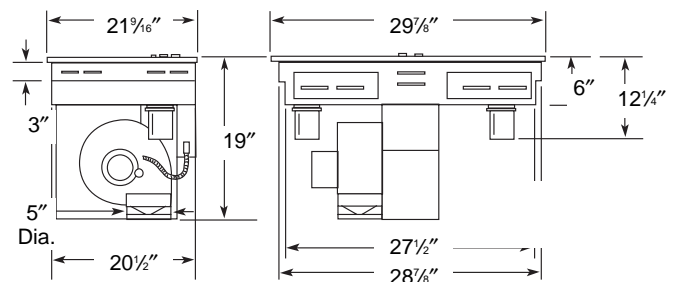



## Step 1

### Preparing for Installation

#### Positioning the cooktop

The cooktop is designed to look best when centered in a cabinet its same width.

The exhaust vent beneath the cooktop must be located between wall studs or floor joists so that ductwork may be installed properly.

At least 6" must be allowed between side edges of cooktop and adjacent walls.

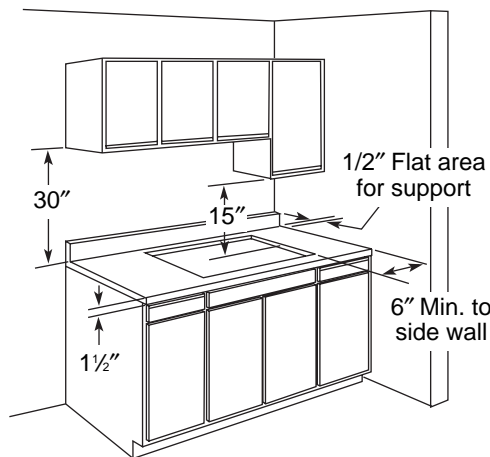

Avoid placing cabinets above the cooktop unit, if possible, in order to reduce the hazards caused by reaching over heated surface units. If cabinets are placed over the cooktop, the risks can be reduced by installing a range hood that projects horizontally a minimum of 5 inches beyond the bottom of the cabinets.

If cabinetry is used above cooktop, allow a minimum 30" clearance between the cooking surface and the bottom of any unprotected cabinet.

If clearance between cooktop and cabinetry is less than 30", cabinet bottom must be protected with flame retardant millboard at least 1/4" thick, covered with 28 gauge sheet steel or 0.020" thick copper. Clearance between cooktop and protected cabinetry must NEVER BE LESS THAN 24".

**EXCEPTION:** Installation of a listed microwave oven or cooking appliance over the cooktop shall conform to the installation instructions packed with that appliance.

A 15" minimum must be kept from the side edge of cooktop to the bottom of any cabinet not directly above cooktop. If clearance is less than 15", adjacent cabinets should be at least 6" from side edge of cooktop.

## Step 2

### Preparing the Base Cabinet

This cooktop is designed to fit easily into a variety of cabinets. However, some cabinets may require modifications.

#### Preparing a cabinet that is against a wall

In some cabinets, the sides may need to be scooped or cut down 2" as shown, and the corner braces removed in order to accommodate the unit.

In 75 cm and 90 cm frameless European cabinets, the back panel may need to be cut down 5" to accommodate the unit.

#### Preparing a peninsula or island type cabinet

In a peninsula or island type cabinet, the sides may need to be scooped or cut down, and the corner braces removed in order to accommodate the unit.

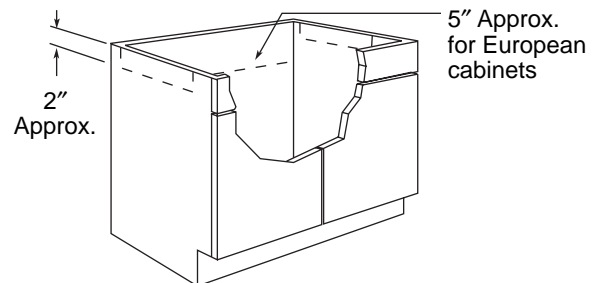

## Step 3

### Rough Preparation of Junction Box

**IMPORTANT—FOR PERSONAL SAFETY, REMOVE HOUSE FUSE OR OPEN CIRCUIT BREAKER BEFORE PREPARING JUNCTION BOX.**

Install an approved junction box within shaded area shown in diagram. Junction box must be at least 10 1/2" below top of cabinet.

Run conductors from residence wiring to junction box according to local electrical codes.

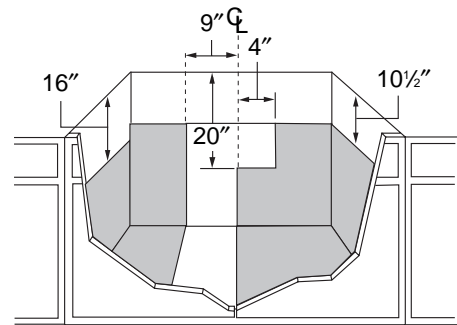

(continued next page)

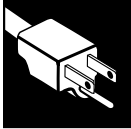

# INSTALLATION INSTRUCTIONS

(continued)

## Step 4

### Preparing the Countertop

Clearance between inside front of cabinet and rear of countertop cutout must be  $20\frac{5}{8}$ " in order to accommodate cooktop depth.

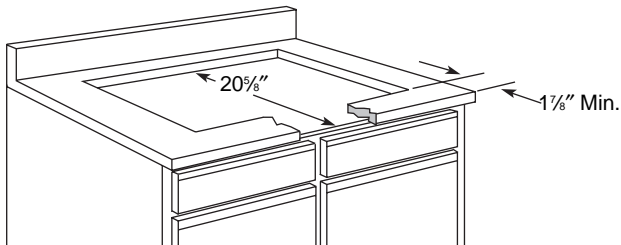

A  $1\frac{1}{2}$ " wide flat area is required around the edge of opening for support of the unit. The cooktop unit must be level and sit squarely into countertop opening.

Carefully cut countertop opening according to the dimensions shown in the illustration. Be sure that opening is cut squarely, with sides parallel to each other and rear exactly perpendicular to sides.

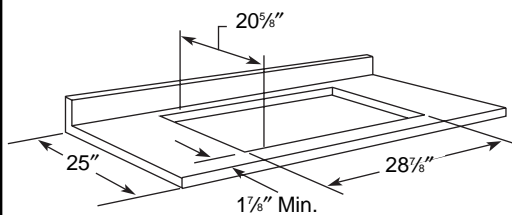

## Step 5

### Preparing for Ductwork

**NOTE: Ductwork MUST be vented to outside. DO NOT vent into a wall, ceiling, crawlspace, attic or any concealed space.**

Cut hole in cabinet wall or floor as appropriate for your installation. Make sure exhaust duct is located between wall studs or floor joists.

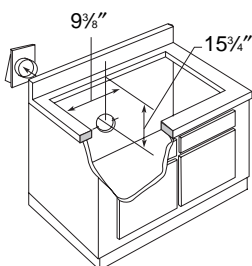

Rear Wall Venting

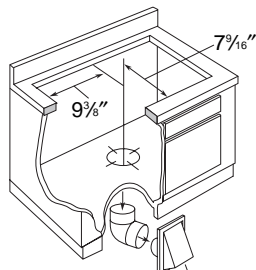

Downward Venting

## Step 5A

### Blower to Ductwork Alignment

In general, the use of flexible ducting is discouraged because it can cause severely restricted airflow. However, if the blower outlet and the floor or wall duct location do NOT align well, then flexible METAL ducting can be used to adapt to an offset. Good alignment without use of flexible ducting is best.

#### NOTE:

- Do not exceed the maximum recommended offset of 3".
- Do not allow the flexible ducting to kink or collapse.
- Do stretch the flexible ducting as much as possible to eliminate as much of the corrugation as possible.
- Do rotate blower slightly to minimize offset (see Step 6).

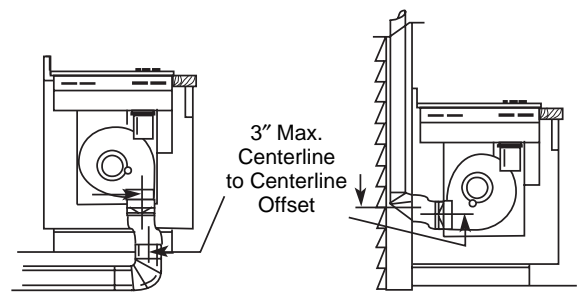

Bottom Venting

Back Venting

## Step 5B

### Determine Flexible Ducting's Equivalent Length

1. Measure the actual amount of offset (maximum 3" recommended). The effect upon airflow is dependent upon the amount of offset.
2. Calculate the equivalent ducting allowances using:  

$$(\text{___ in. offset}) \times (14 \text{ ft. per inch}) = \text{___ ft. equivalent length.}$$
3. Enter the calculated value into TABLE 1 of this Installation Instruction.
4. Ensure that the total equivalent length of ducting does not exceed the maximum recommendation of 100 feet.



## Step 6

### Installing the Ductwork

Use minimum 26 gauge galvanized or 24 gauge aluminum duct in 6" round or 3/4" x 10" size, or combination of both.

PVC duct should be used if installing under a poured concrete slab.

**NOTE:** Local building code must be followed in specifying approved type and schedule of PVC duct used.

5" round duct may be used on SHORT DUCT runs. But, note higher equivalent lengths for each 5" dia. piece used. Don't convert back to 5" duct after use of 6" round or 3/4" x 10" duct.

Always use an appropriate roof or wall cap with damper. Laundry type wall caps should NEVER be used.

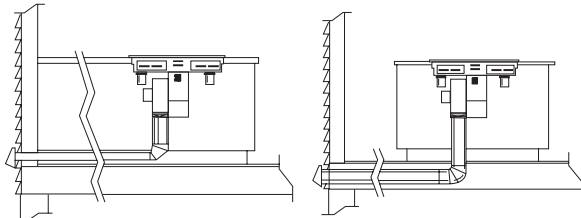

Thru Cabinet Toe Space

Between Floor Joist

Downward Venting

Install ductwork, making male-female connections in direction of airflow as shown. Secure all joints with sheet metal screws and duct tape to assure airtight seal.

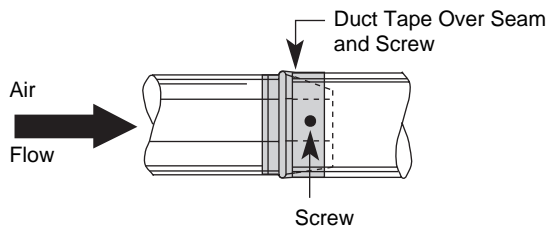

Select downward or wall venting. To convert blower exhaust direction, remove four nuts inside the plenum which hold blower and wire finger guard. Remove blower and rotate so that exhaust faces downward or rear direction, as needed. Replace wire finger guard and nuts. Retighten nuts.

Blower exhaust direction can be adjusted slightly while in its vertical or horizontal direction by loosening four nuts holding blower, rotating blower and retightening nuts.

Use the shortest and straightest duct run possible. For satisfactory performance the duct run should not exceed 100 feet equivalent length. Refer to TABLE 1 of equivalent lengths. Use TABLE 1 to calculate the total equivalent length of the ductwork.

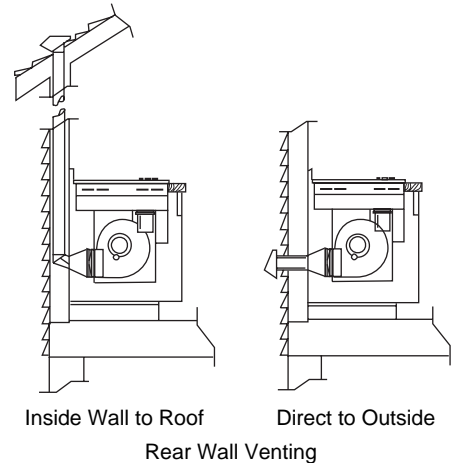

Inside Wall to Roof

Direct to Outside

Rear Wall Venting

*(continued next page)*

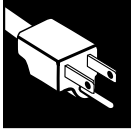









# INSTALLATION INSTRUCTIONS

(continued)

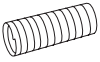
**TABLE 1**

**Calculate Total Equivalent Ductwork Length**

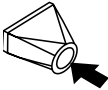
| Duct Pieces   |                                     | Equivalent Length* x        | Number Used           | = | Equivalent Length |
|---|-------------------------------------|-----------------------------|-----------------------|---|-------------------|
|    | 5" round straight                   | 2.7                         | x ( ft.) <sup>†</sup> | = | ft.               |
|   | 6" round straight                   | 1                           | x ( ft.) <sup>†</sup> | = | ft.               |
|    | 3 1/4" x 10" straight               | 1                           | x ( ft.) <sup>†</sup> | = | ft.               |
|    | 5", 90° elbow                       | 37 ft.                      | x ( )                 | = | ft.               |
|   | 6", 90° elbow                       | 15 ft.                      | x ( )                 | = | ft.               |
|    | 5", 45° elbow                       | 18 ft.                      | x ( )                 | = | ft.               |
|   | 6", 45° elbow                       | 9 ft.                       | x ( )                 | = | ft.               |
|    | Flexible Metal Offset Adapter       | See Calculations in Step 5A |                       | = | ft.               |
|   | 3 1/4" x 10" 90° elbow              | 16 ft.                      | x ( )                 | = | ft.               |
|  | 3 1/4" x 10" 45° elbow              | 5 ft.                       | x ( )                 | = | ft.               |
|  | 3 1/4" x 10" 90° flat elbow         | 18 ft.                      | x ( )                 | = | ft.               |
|  | 5" round to 3 1/4" x 10" transition | 3 ft.                       | x ( )                 | = | ft.               |
|   | 6" round to 3 1/4" x 10" transition | 7 ft.                       | x ( )                 | = | ft.               |
| Subtotal Column 1   |                                     |                             |                       | = | ft.               |







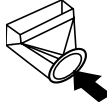

\* Equivalent lengths of duct pieces are based on actual tests and reflect requirements for good venting performance with any downdraft cooktop.

† Measure and list feet of straight duct used. Count and list the quantity of all other duct pieces for the "Number Used" of each type.

**IMPORTANT**

For maximum efficiency, use the shortest and straightest duct run possible, with as few fittings as possible. **For satisfactory performance, the duct run should not exceed 100 feet equivalent length.**

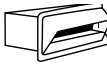
Venting performance is improved by using larger diameter duct.

| Duct Pieces   |   | Equivalent Length* x | Number Used | = | Equivalent Length |
|---|---|----------------------|-------------|---|-------------------|
|    | 5" round to 3 1/4" x 10" transition 90° elbow | 37 ft.               | x ( )       | = | ft.               |
|   | 6" round to 3 1/4" x 10" transition 90° elbow | 20 ft.               | x ( )       | = | ft.               |
|    | 3 1/4" x 10" to 6" round transition           | 5 ft.                | x ( )       | = | ft.               |
|    | 3 1/4" x 10" to 6" round transition 90° elbow | 12 ft.               | x ( )       | = | ft.               |
|    | Tapered 5" round to 6" round transition       | 6 ft.                | x ( )       | = | ft.               |
|    | 5" round collar to 6" round cap transition    | 13 ft.               | x ( )       | = | ft.               |
|  | 5" round wall cap with damper                 | 84 ft.               | x ( )       | = | ft.               |
|   | 6" round wall cap with damper                 | 21 ft.               | x ( )       | = | ft.               |
|  | 3 1/4" x 10" wall cap with damper             | 27 ft.               | x ( )       | = | ft.               |
|  | 6" round roof cap                             | 20                   | x ( )       | = | ft.               |
|  | 6" round roof vent                            | 24                   | x ( )       | = | ft.               |
| Subtotal Column 2   |   |                      |             | = | ft.               |
| Subtotal Column 1   |   |                      |             | = | ft.               |
| <b>TOTAL DUCTWORK=</b>  |   |                      |             | = | ft.               |

**Should not exceed 100 feet.**

If flexible metal ducting is used, all the equivalent feet values in the table should be doubled. The flexible metal duct should be straight and smooth and extended as much as possible.

**DO NOT use flexible plastic ducting.**

Vent installation should not exceed 100 feet equivalent length.

Blower is rated at **400 CFM** at 0.1 inch of water back pressure.



## Step 7

### Install 1/2" Flexible Conduit with Supplied Clamp

**NOTE:** A clamp has been included with the cooktop for installing the 1/2" flexible conduit.

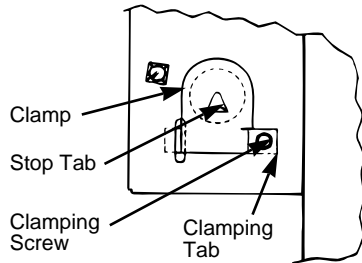

Remove the screws holding the wire compartment cover and remove the cover.

Remove the clamping screw and the clamp.

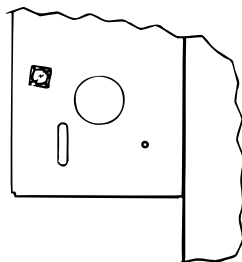

Feed the power supply leads through the conduit; be sure to leave enough length to properly connect these leads to the cooktop power leads.

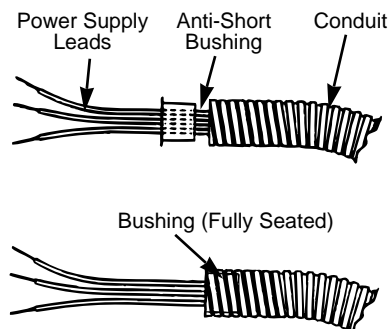

Thread the leads through an anti-short bushing and firmly seat the bushing in the end of the conduit.

Feed the leads through the hole in the wire compartment.

Lay the conduit against the side of the wire compartment.

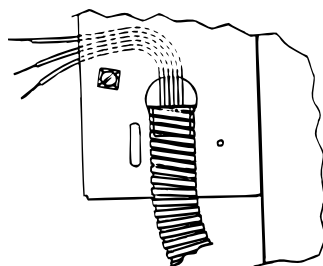

Place the clamp over the conduit. Make sure the bushing is fully seated against the stop tab in the clamp.

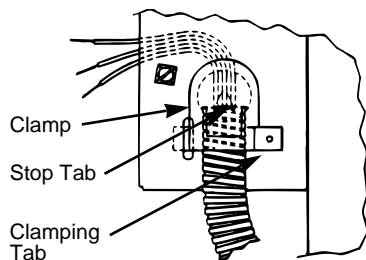

Tighten the clamping screw until the clamping tab is fully seated against the wire compartment.

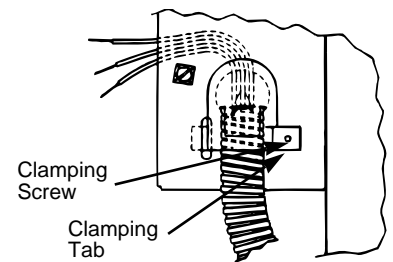

Complete the rest of the installation observing local codes (see Steps 9 and 10).

When complete reinstall the wire compartment cover.

## Step 8

### Installing the Cooktop

Remove grease jar(s) from beneath cooktop to avoid breakage. Remove vent grille from cooktop's surface. Using 2 people, position cooktop over countertop opening, with power cable inserted through the opening.

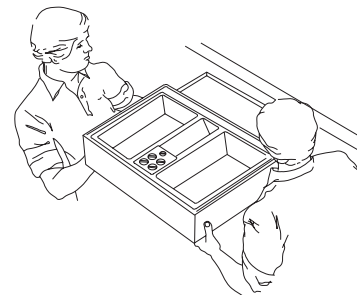

Holding cooktop by side edges, lower it into countertop opening.

Replace jar(s) and vent grille.

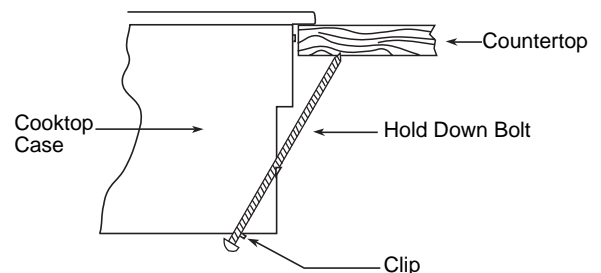

Secure cooktop by tightening hold-down bolts in bottom of the cooktop case. (2 bolts, 1 per side.)

*(continued next page)*

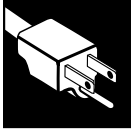

# INSTALLATION INSTRUCTIONS

(continued)

## Step 9

### Before Making Electrical Connections

**Note to Electrician:** The power leads supplied with this appliance are U. L. recognized for connection to large gauge household wiring. The insulation of these leads is rated at temperatures much higher than the temperature rating of household wiring. The current carrying capacity of a conductor is governed by the wire gauge and also the temperature rating of the insulation around the wire.

**Aluminum Wiring**—WARNING: IMPROPER CONNECTION OF ALUMINUM HOUSE WIRING TO THE COPPER LEADS CAN RESULT IN SERIOUS PROBLEMS.

Attach copper wires to aluminum wiring using special connectors designed and U. L. listed for joining copper to aluminum. Follow the connector manufacturer's recommended procedure closely.

## Step 10

### Making Electrical Connections

**NOTE:** The frame of this appliance is grounded to neutral.

#### 3-Conductor Branch Circuit

When connecting cooktop to a 3-conductor circuit, connect the red leads of the cooktop and the power supply to the branch circuit red lead; connect the black leads to each other. Connect the green and white leads of the cooktop to the power supply and branch circuit neutral leads, which are white or gray.

3-Conductor Branch Circuit

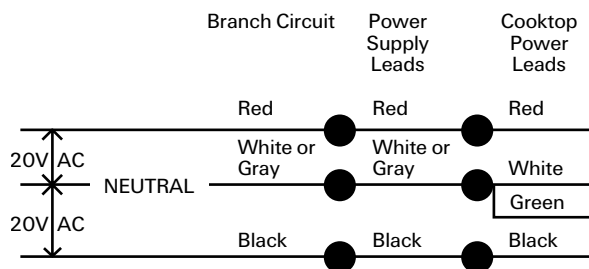

#### 4-Conductor Branch Circuit

When connecting cooktop to a 4-conductor circuit, connect the red leads of the cooktop and the power supply to the branch circuit red lead; connect the black leads to each other. Separate the green and white leads of the cooktop. Connect cooktop white lead to the power supply and branch circuit neutral leads, which are white or gray. Ground the unit by connecting the green conductor of the cooktop to the bare or green leads of the power supply and branch circuit (ground leads).

4-Conductor Branch Circuit

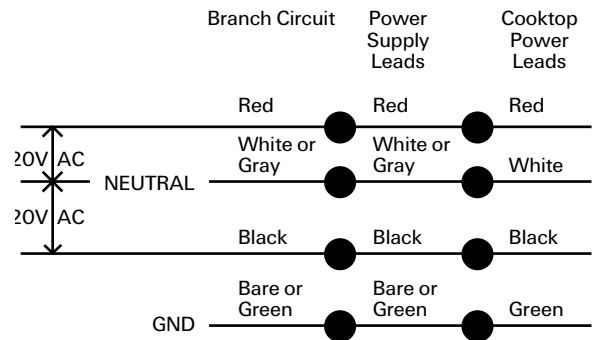

#### Electrical Requirements\*

| Model #      | Voltage  | Frequency | KW    |
|--------------|----------|-----------|-------|
| JP385, JP389 | 120/240V | 60HZ      | 8.0KW |
| JP387        | 120/208V | 60Hz      | 7.6KW |

\*For reference only. Verify with products rating plate.

# QUESTIONS? USE THIS PROBLEM SOLVER



| PROBLEM   | POSSIBLE CAUSE   |
|---|--|
| <p>MODULES ARE NOT FUNCTIONING PROPERLY</p>   | <ul style="list-style-type: none"> <li>• Difficulty may be in the main distribution panel of your house, caused by a blown circuit fuse, a tripped circuit breaker, the main fuse or the main circuit breaker, depending on nature of the power supply. If a circuit breaker is involved, reset it. If the control box uses fuses, the circuit fuse (a cartridge-type) should be changed, <b>BUT ONLY BY SOMEONE FAMILIAR WITH ELECTRICAL CIRCUITS</b>. If, after performing 1 of these procedures, the fuse blows or circuit breaker trips again, call for service.</li> <li><b>NOTE:</b> Apartment tenants or condominium owners should request their building management to perform this check before calling for service.</li> <li>• Controls are not properly set or wrong control is set for the module or element you are using.</li> <li>• Entire surface unit module is not plugged in properly.</li> <li>• If any module fails to heat—switch the module to the other side of cooktop. If it operates on that side, then switch may be at fault. If it does not heat, indications are that there is a malfunctioning component in the module.</li> </ul> |
| <p>COIL SURFACE UNITS ARE NOT FUNCTIONING PROPERLY</p>  | <ul style="list-style-type: none"> <li>• Surface units are not plugged in solidly.</li> <li>• Reflector pans are not set securely in the cooktop.</li> <li>• Surface unit controls are not properly set or wrong surface unit control set for unit you are using.</li> </ul>   |
| <p>GRILL OR GRIDDLE UNIT IS NOT FUNCTIONING PROPERLY</p>  | <ul style="list-style-type: none"> <li>• Heating element is not plugged in solidly.</li> <li>• Grill or Griddle heating element controls are not properly set.</li> <li>• To use the entire surface of the grill or griddle, it is necessary to turn on the front and rear surface unit control settings for the side you are using.</li> </ul>  |
| <p>FOODS STICK TO GRILL OR GRIDDLE</p>  | <ul style="list-style-type: none"> <li>• Griddle was not pre-seasoned before first use.</li> <li>• Heat setting is too high.</li> <li>• Coating of griddle has been damaged by use of sharp instruments or abrasive cleaners.</li> </ul>   |
| <p>EXCESSIVE SMOKE FROM GRILLED MEATS</p>   | <ul style="list-style-type: none"> <li>• Accumulated grease in reflector pan or food soils on grate are causing excess smoke.</li> <li>• Fats not trimmed from meats prior to cooking.</li> </ul>  |
| <p>COOKTOP FEELS HOT</p>  | <ul style="list-style-type: none"> <li>• <b>Make sure flat-bottomed pans are used.</b></li> <li>• Using the vent will help keep the cooktop cooler.</li> </ul>   |
| <p>RADIANT SURFACE UNITS WILL NOT MAINTAIN A ROLLING BOIL AND/OR FRYING RATE IS NOT FAST ENOUGH</p> | <ul style="list-style-type: none"> <li>• Absolutely flat pans must be used. If light can be seen between the pan bottom and a straight edge, the radiant surface units will not operate properly.</li> </ul>   |

*(continued next page)*



## PROBLEM SOLVER

(continued)

| PROBLEM  | POSSIBLE CAUSE   |
|--|--|
| TINY SCRATCHES<br>(may appear as cracks) OR<br>ABRASIONS ON RADIANT<br>COOKTOP GLASS SURFACE | <ul style="list-style-type: none"><li>• Incorrect cleaning methods have been used, cookware with rough bottoms has been used, or coarse particles (salt or sand) were between the cookware and the surface of cooktop. Use recommended cleaning procedures, be sure cookware bottoms and cookware are clean before use, and use cookware with smooth bottoms. Tiny scratches are not removable but will become less visible in time as a result of cleaning.</li></ul> |
| METAL MARKINGS<br>(may appear as scratches on<br>radiant cooktop glass surface)              | <ul style="list-style-type: none"><li>• Do not slide aluminum cookware across the surface. Use recommended cleaning procedure to remove marks.</li><li>• Incorrect cleaning materials have been used, encrusted boilovers or grease spatters remain on the surface. Use a razor scraper and recommended cleaning procedure.</li></ul>  |
| DARK STREAKS OR SPECKS<br>ON RADIANT MODULE  | <ul style="list-style-type: none"><li>• Use a razor scraper and recommended cleaning procedure.</li></ul>  |
| AREAS OF<br>DISCOLORATION<br>ON RADIANT<br>SURFACE COOKTOP                                   | <ul style="list-style-type: none"><li>• Mineral deposits from water or food can be removed with Cook Top Cleaning Creme.</li></ul>   |
| HOT SUGAR MIXTURES/<br>PLASTIC MELTED TO<br>THE RADIANT SURFACE                              | <ul style="list-style-type: none"><li>• Turn the surface unit to LO, wipe the hot cooktop with several dry paper towels. Use a razor scraper held at a 30° angle to the cooktop to scrape the hot spill to a cool area outside the surface unit. Let the cooktop cool. Clean with Cook Top Cleaning Creme.</li></ul>   |
| FREQUENT CYCLING<br>OFF AND ON OF RADIANT<br>SURFACE UNITS                                   | <ul style="list-style-type: none"><li>• Incorrect cookware used. Use only flat cookware to minimize cycling.</li></ul>   |

**If you need more help...call, toll free:**  
**GE Answer Center®**  
**800.626.2000**  
**consumer information service**

---

# NOTES

---

# NOTES

# We'll Be There

With the purchase of your new GE appliance, receive the assurance that if you ever need information or assistance from GE, we'll be there. All you have to do is call—toll-free!

## **GE Answer Center®** **800.626.2000**

Whatever your question about any GE major appliance, GE Answer Center® information service is available to help. Your call—and your question—will be answered promptly and courteously. And you can call any time. GE Answer Center® service is open 24 hours a day, 7 days a week.

## **In-Home Repair Service** **800-GE-CARES (800-432-2737)**

A GE consumer service professional will provide expert repair service, scheduled at a time that's convenient for you. Many GE Consumer Service company-operated locations offer you service today or tomorrow, or at your convenience (7:00 a.m. to 7:00 p.m. weekdays, 9:00 a.m. to 2:00 p.m. Saturdays). Our factory-trained technicians know your appliance inside and out—so most repairs can be handled in just one visit.

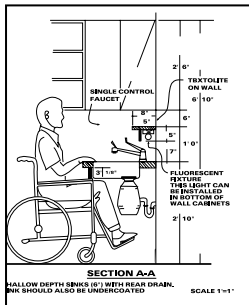

## **For Customers With Special Needs...** **800.626.2000**

GE offers, free of charge, a brochure to assist in planning a barrier-free kitchen for persons with limited mobility.

Consumers with impaired hearing or speech who have access to a TDD or a conventional teletypewriter may call 800-TDD-GEAC (800-833-4322) to request information or service.

## **Service Contracts** **800-626-2224**

You can have the secure feeling that GE Consumer Service will still be there after your warranty expires. Purchase a GE contract while your warranty is still in effect and you'll receive a substantial discount. With a multiple-year contract, you're assured of future service at today's prices.

## **Parts and Accessories** **800-626-2002**

Individuals qualified to service their own appliances can have parts or accessories sent directly to their home. The GE parts system provides access to over 47,000 parts...and all GE Genuine Renewal Parts are fully warranted. VISA, MasterCard and Discover cards are accepted.

User maintenance instructions contained in this guide cover procedures intended to be performed by any user. Other servicing generally should be referred to qualified service personnel. Caution must be exercised, since improper servicing may cause unsafe operation.

# YOUR GE BUILT-IN COOKTOP WARRANTY

**Staple sales slip or cancelled check here. Proof of original purchase date is needed to obtain service under warranty.**

## WHAT IS COVERED

### FULL ONE-YEAR WARRANTY

For one year from date of original purchase, we will provide, free of charge, parts and service labor in your home to repair or replace **any part of the cooktop** that fails because of a manufacturing defect.

\*\*\*\*\*  
**FULL FIVE-YEAR WARRANTY**

(on radiant/halogen models) For five years from the date of original purchase, we will provide, free of charge, parts and service labor in your home to repair or replace the glass cooktop due to:

- Cracking of the glass cooktop due to thermal shock
- Discoloration of the glass cooktop
- Wear off of the pattern on the glass cooktop
- Cracking of the rubber seal between the glass top and the frame
- Burn out of any of the radiant or halogen surface units.

This warranty is extended to the original purchaser and any succeeding owner for products purchased for ordinary home use in the 48 mainland states, Hawaii and Washington, D.C. In Alaska the warranty is the same except that it is LIMITED because you must pay to ship the product to the service shop or for the service technician's travel costs to your home.

All warranty service will be provided by our Factory Service Centers or by our authorized Customer Care® servicers during normal working hours.

Should your appliance need service, during warranty period or beyond, call 800-GE-CARES (800-432-2737).

## WHAT IS NOT COVERED

- Service trips to your home to teach you how to use the product.

### Read your Use and Care material.

If you then have any questions about operating the product, please contact your dealer or our Customer Relations office at the address below, or call, toll free:

GE Answer Center®  
800.626.2000  
consumer information service

- Improper installation. If you have an installation problem, contact your dealer or installer. You are responsible for providing adequate electrical, gas, exhausting and other connecting facilities as described in the Installation Instructions provided with the product.
- Replacement of house fuses or resetting of circuit breakers.
- Damage to the glass cooktop caused by use of cleaners other than the cooktop creme provided with the product.

- Damage to the glass cooktop caused by hardened spills of sugary materials or melted plastic that are not cleaned according to the directions in the Use and Care Guide.
- Damage to the product due to misuse or abuse.
- Failure of the product if it is used for other than its intended purpose or used commercially.
- Damage to product caused by accident, fire, floods or acts of God.

**WARRANTOR IS NOT RESPONSIBLE FOR CONSEQUENTIAL DAMAGES.**

Some states do not allow the exclusion or limitation of incidental or consequential damages, so the above limitation or exclusion may not apply to you. This warranty gives you specific legal rights, and you may also have other rights which vary from state to state. To know what your legal rights are in your state, consult your local or state consumer affairs office or your state's Attorney General.

**Warrantor: General Electric Company**

**If further help is needed concerning this warranty, write:  
Manager—Customer Relations, GE Appliances, Louisville, KY 40225**

Part No. 164D2966P185-1

Pub No. 49-8672-1

D-952-893-0

12-98 CG

JP385

JP387

JP389

Printed in the United States