



IMPORTANT INSTRUCTIONS
SAVE THESE INSTRUCTIONS

MODE D'EMPLOI IMPORTANT
CONSERVEZ LES PRESENTES INSTRUCTIONS

INSTRUCCIONES IMPORTANTES
GUARDE ESTAS INSTRUCCIONES

ISTRUZIONI IMPORTANTI
CONSERVARE LE ISTRUZIONI



BCO264B

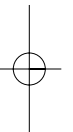
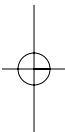

COFFEE MAKER



CAFETERIE



CAFETERA



MACCHINA DA CAFFÈ

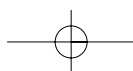

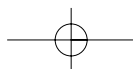
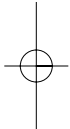
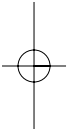
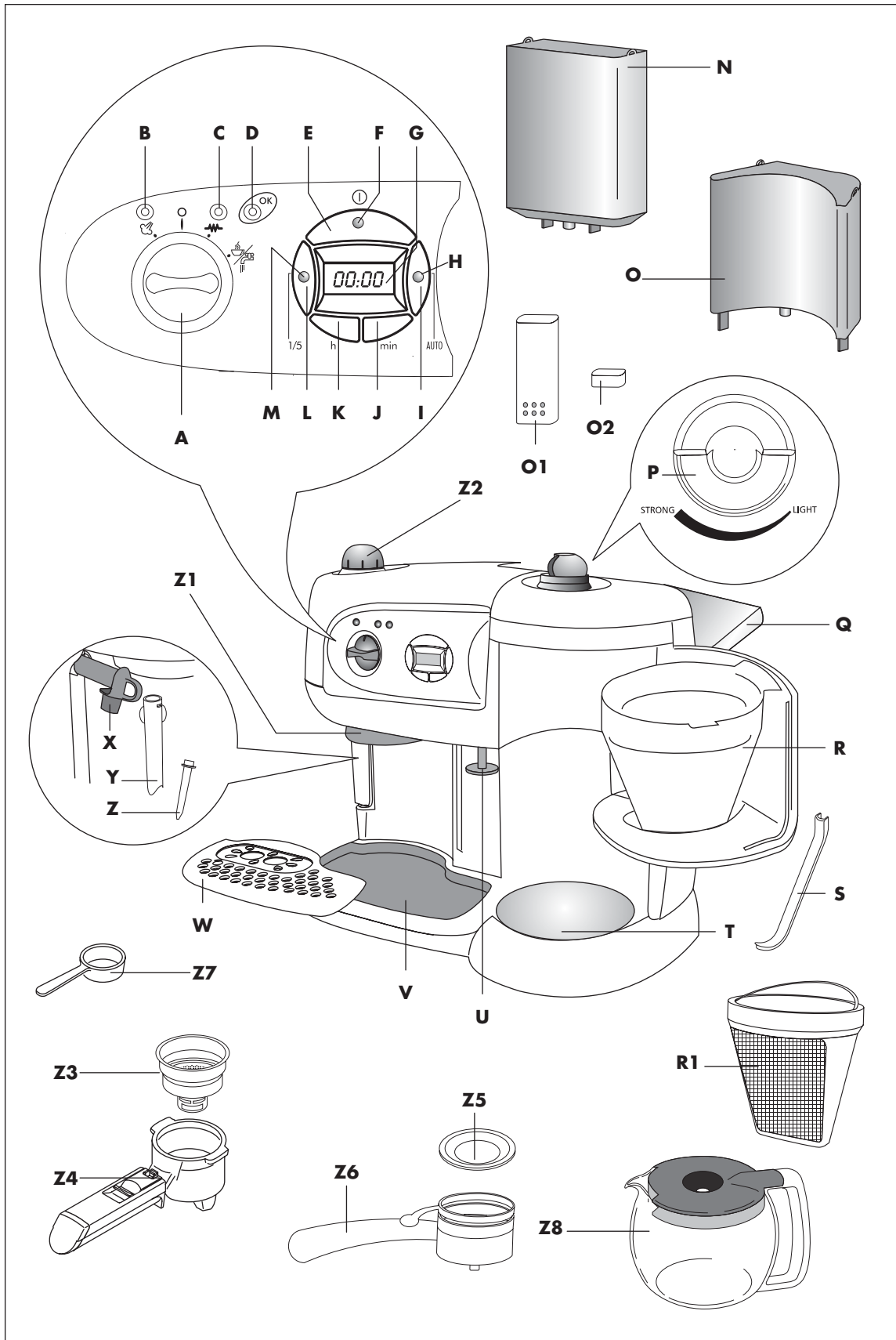

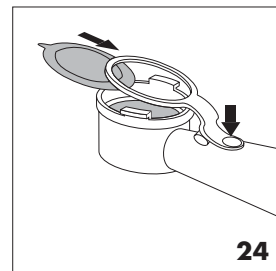
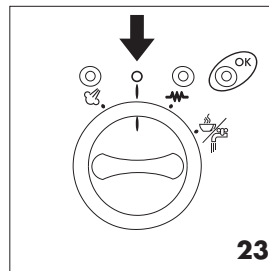
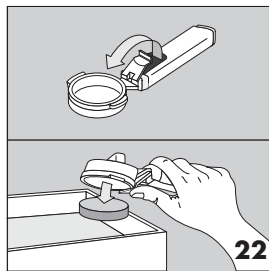
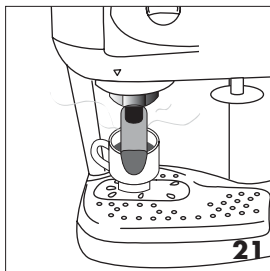
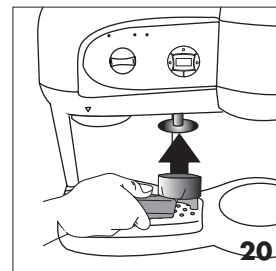
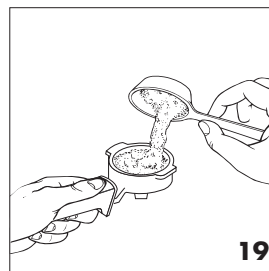
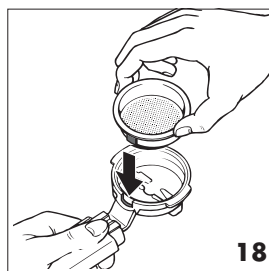
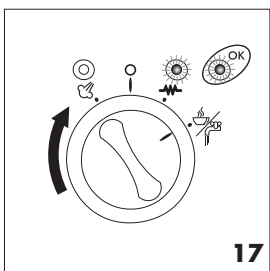
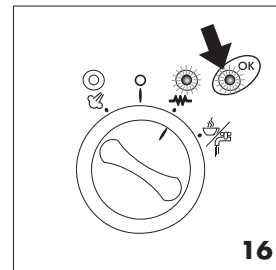
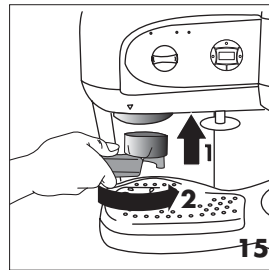
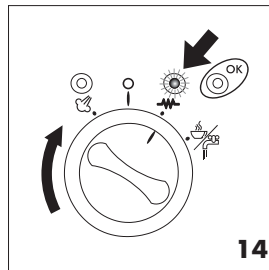
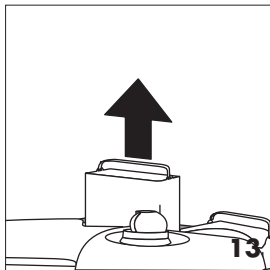
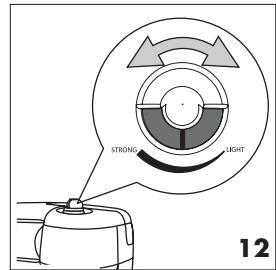
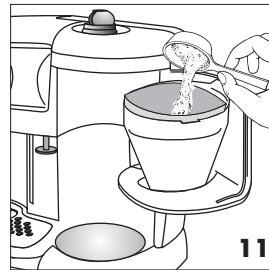
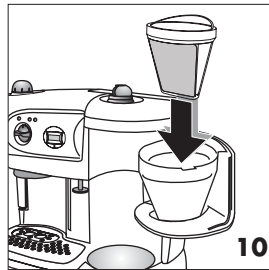
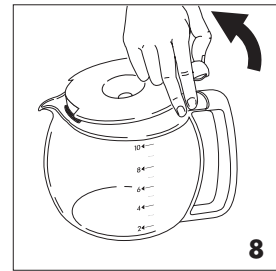
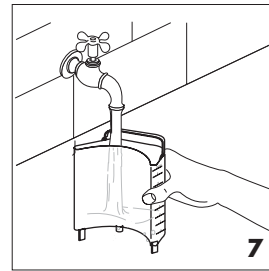
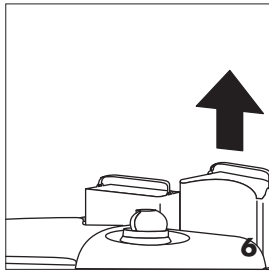
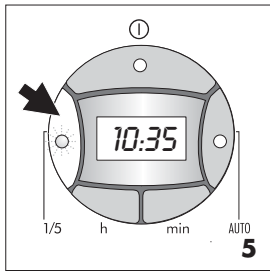
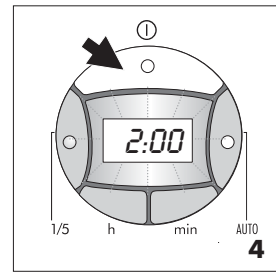
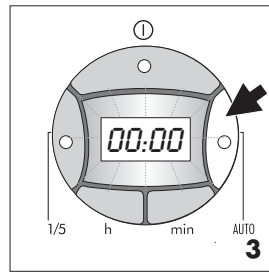
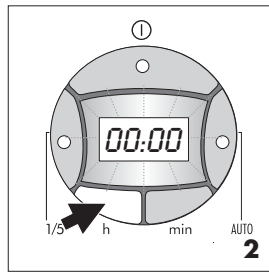
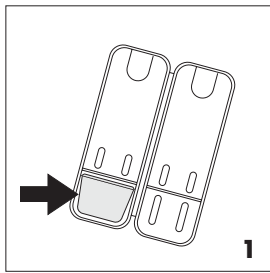

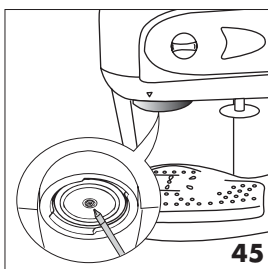
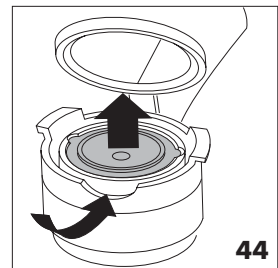
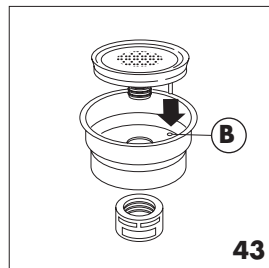
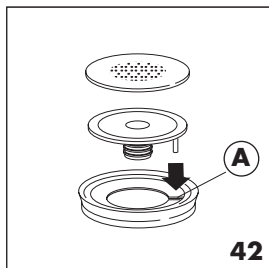
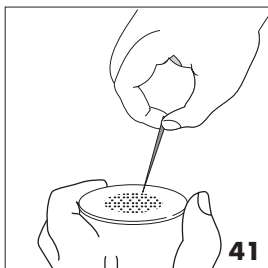
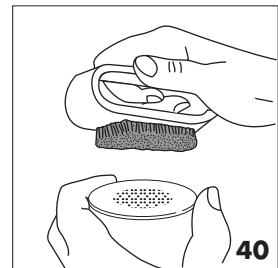
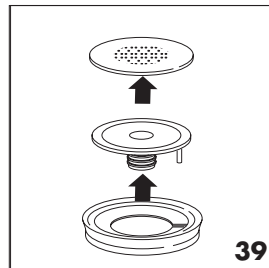
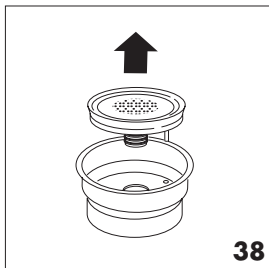
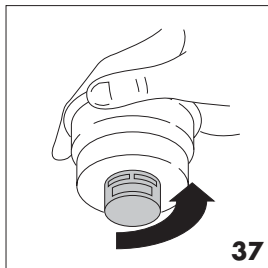
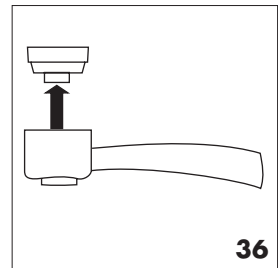
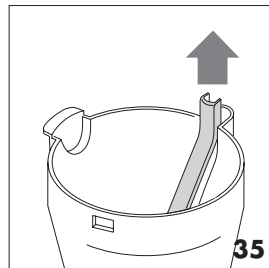
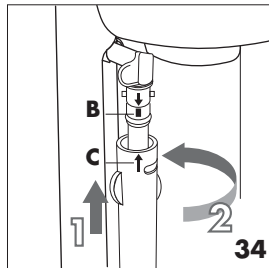
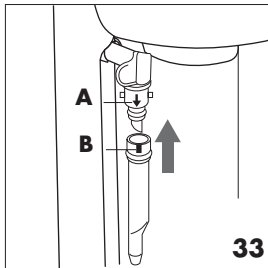
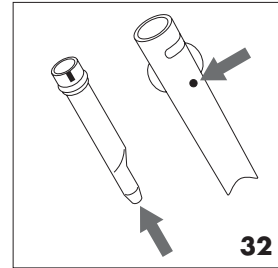
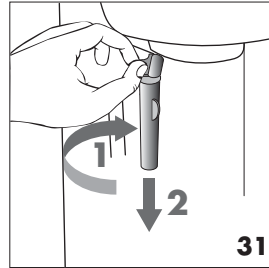
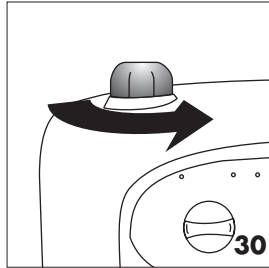
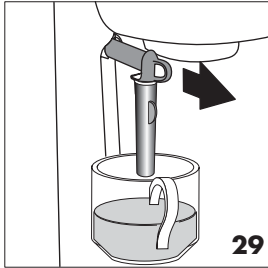
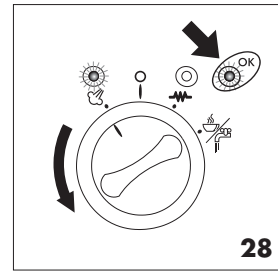
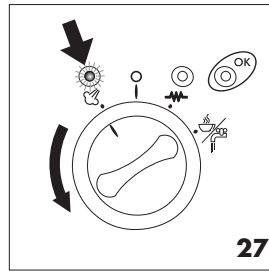
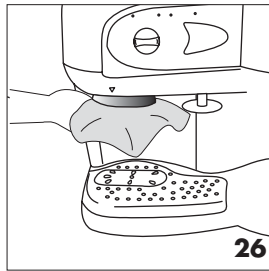
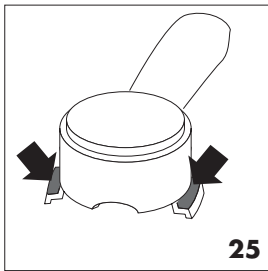



IMPORTANT SAFEGUARDS

When using electrical appliances, basic safety precautions should always be followed, including the following:

- Read all instructions.
- Do not touch hot surfaces. Use handles and knobs.
- To protect against fire, electrical shock and personal injury, do not immerse cord, plug or appliance in water or other liquid.
- Close supervision is necessary when any appliance is used by or near children.
- Unplug from the outlet when not in use and before cleaning. Allow to cool before fitting or taking off parts, and before cleaning the appliance.
- Do not operate with a damaged cord or plug, or after the appliance malfunctions, or has been damaged in any manner. Return the appliance to the nearest authorized De'Longhi service facility for examination, repair or adjustment.
- The use of accessory attachments or spare parts not recommended by the appliance manufacturer may result in fire, electrical shock or personal injury.
- Do not use outdoors.
- Do not let the cord hang over the edge of the table or counter, or touch hot surfaces.
- Do not place on or near a hot gas or electrical burner, or in a heated oven.
- To disconnect the appliance, turn any control to "off", then remove plug from wall outlet.
- Do not use the appliance for other than the intended use.
- Appliances with Glass Containers:
 - A. The container is designed for use with this appliance. It must never be used on a range top.
 - B. Do not set a hot container on a wet or cold surface.
 - C. Do not use a cracked container or a container having a loose or weakened handle.
 - D. Do not clean container with cleansers, steel wool pads, or other abrasive material.

SAVE THESE INSTRUCTIONS
THIS PRODUCT IS FOR HOUSEHOLD USE ONLY

SHORT CORD INSTRUCTIONS

- A short power cord is provided to reduce risks resulting from becoming entangled in or tripping over a longer cord.
- Longer, detachable power supply cords or extension cords are available and may be used if care is exercised in their use.
- If an extension cord is used, the marked electrical rating should be at least as great as the electrical rating of the appliance. The longer cord should be arranged so that it will not drape over the counter-top or table top where it can be pulled on by children or tripped over.
- Your product is equipped with a polarized alternating current line plug (a plug having one blade wider than the other). This plug will fit into the power outlet only one way. This is a safety feature. If you are unable to insert the plug fully into the outlet, try reversing the plug. If the plug should still fail to fit, contact your electrician to replace your obsolete outlet. Do not defeat the safety purpose of the polarized plug.

Please read this instruction booklet carefully before installing and operating the appliance. This is the only way to ensure the best results and maximum safety for the user.

DESCRIPTION OF THE APPLIANCE

The following terminology will be used on subsequent pages.

- A** Espresso or steam selector knob
- B** Steam indicator light
- C** Espresso on indicator light
- D** Espresso or steam OK indicator light
- E** Drip coffee on/off button
- F** Drip coffee on/off indicator light
- G** Digital display
- H** AUTO indicator light
- I** Delayed start-up button
- J** Minute set button
- K** Hour set button
- L** 1-5 cups button
- M** 1-5 cups indicator light
- N** Espresso water tank
- O** Drip coffee water tank
- O** 1 Chlorine filter holder (if fitted)
- O2** Chlorine filter (if fitted)
- P** Drip coffee "AccuFlavor Selector"
- Q** Water tank cover
- R** Drip coffee filter holder
- R1** Permanent platinum filter
- S** Flavor Savor Channel
- T** Drip coffee warming plate
- U** Tamper
- V** Drip tray
- W** Cup tray for espresso coffee
- X** Steam delivery tube
- Y** Cappuccino frother
- Z** Nozzle
- Z1** Espresso boiler outlet
- Z2** Steam knob for cappuccino coffee
- Z3** Filter with frother
- Z4** Filter holder for espresso coffee
- Z5** Filter for pods
- Z6** Filter holder for pods
- Z7** Measuring Spoon
- Z8** Carafe for drip coffee

SAFETY WARNINGS

- This appliance is designed to "make espresso" and "heat drinks". Use with care to avoid scalds from the water and steam jets or through incorrect use.
- Never touch hot parts.

- After removing the packaging, make sure the product is complete. If in doubt, do not use the appliance and contact qualified De'Longhi personnel only.
- Do not leave packaging (plastic bags, polystyrene foam, etc) within reach of children as they could be dangerous.
- This appliance is for household use only. All other uses are considered improper and thus dangerous.
- The manufacturer cannot be held responsible for any damage caused by improper, erroneous and unreasonable use.
- Never touch the appliance with damp or wet hands or feet.
- Never allow the appliance to be used by children without supervision.
- Never allow children to play with the appliance.
- In the event of failure or malfunction, switch off the appliance and do not tamper with it in any way. If the appliance requires repair, contact an authorized technical De'Longhi service center only and ask for original spare parts to be used. Failure to respect the above could reduce the safety of the appliance.
- The power cord must never be replaced by the user as this requires the use of special tools. If the cable is damaged or requires replacing, contact an authorized service center only to avoid all risks.

INSTALLATION

- Place the appliance on a work surface far away from water taps and basins.
- Check that the outlet corresponds to the voltage on the appliance rating plate. Connect the appliance to an efficiently grounded outlet with a minimum rating of 10A only. The manufacturer may not be considered liable for possible incidents caused by the failure to adequately ground the outlet.
- If the plug fitted to the appliance does not match the power outlet, have the socket replaced with a suitable type by qualified personnel.
- Never install the machine in environments where the temperature may reach 0°C (32 F) or lower (the appliance may be damaged if the water freezes).

CHLORINE FILTER

The filter eliminates the taste of chlorine from the water. To install the filter, proceed as follows :

- Remove the chlorine filter from the plastic bag and rinse it in tap water.
- Lift the coffee lid, remove the filter holder from its housing by lifting it upwards.
- Open the filter holder by pressing the parts marked "PUSH", and carefully position the filter as shown in Fig. 1.

- The chlorine filter must be replaced every 80 cycles, and always after six months of operation.

HOW TO MAKE DRIP COFFEE

HOW TO SET THE CLOCK

When the coffee machine is connected to the outlet for the first time, the numbers 0:00 will flash on the display.

To set the time, proceed as follows:

1. Press the "HOUR" button (fig. 2) for about 2 seconds until the number of hours on the display increases;
2. Before the display stops flashing (about 5 seconds), set the time required by repeatedly pressing the HOUR button.
3. Set the minutes by repeatedly pressing the MIN button (to speed up the operation, hold the button down).
4. After setting the hour, wait 5 seconds. When the display stops flashing, the hour programmed is memorized.

To reset the hour, press the HOUR button for about 2 seconds then follow the procedure described in point 2. The hour set will not be retained in the memory in the event of temporary power failure.

PROGRAMMING AUTOMATIC START-UP.

You can program the appliance to prepare drip coffee automatically.

Make sure the time is set correctly. To set delayed start-up (the time you want to make the coffee), proceed as follows:

1. Press the "AUTO" button (fig. 3) for about 2 seconds until 0:00 flashes on the display;
2. Before the display stops flashing (about 5 seconds), set the time required by repeatedly pressing the HOUR button.
3. Set the minutes by repeatedly pressing the MIN button.
4. After 5 seconds, the display will stop flashing and the programmed time will be memorized;
5. After programming the appliance, to obtain coffee at the time set, just press the AUTO button. The indicator light on the button will come on.

If you want to change the delayed start up time set, press the AUTO button for about 2 seconds then set a new time as described in point 2.

Bear in mind that at the time set, the appliance will start to make drip coffee only. The espresso function will not start.

LENGTH OF WARMING TIME (AUTOMATIC SHUT-OFF TIME)

The appliance is programmed by the manufacturer to keep the coffee hot for two hours after start-up.

However, this setting can be changed as follows:

1. Press the coffee "ON/OFF" button (fig. 4) for about 2 seconds until 0:00 flashes on the display;
2. Modify the time required by repeatedly pressing the HOUR button (and also the MIN button if required);
3. After setting the time, wait 5 seconds. When the display stops flashing, the time will be memorized:
Note: If 0:00 is set, the appliance keeps the coffee hot for an unlimited period of time.

SETTING 1 – 5 CUPS

To improve extraction and the aroma when making less than 6 cups, press the 1-5 cups coffee button (fig. 5). The 1-5 cups coffee LED will light up.

PREPARING DRIP COFFEE

- Lift the cover and remove the water tank on the right (fig. 6).
- Fill the tank with fresh clean water up to the mark corresponding to the number of cups of coffee to be prepared, taking care not to exceed the MAX level (fig. 7).
- Replace the tank in the appliance, pressing lightly to open the valve on the bottom of the tank. The tank may also be filled without being removed using the drip coffee carafe marked with the level indicators (fig. 8).
- Open the filter holder by rotating towards the right (fig. 9).
- Position the permanent platinum filter or the paper filter in the filter holder (fig. 10).
- Place the ground coffee in the filter, using the measuring spoon supplied, and level evenly (Fig. 11).

According to coffee industry standards, use one standard coffee measure (2 level tablespoons) of coffee grounds for each six ounces of water.

The quantity of ground coffee used may, however, be varied according to personal taste. Use good quality, medium ground coffee for drip coffee machines.

- Close the filter holder and place the carafe on the warming plate with the lid on.
- Choose the desired flavor as indicated in the paragraph "HOW TO CHOOSE THE FLAVOR OF DRIP COFFEE".

Note: The coffee machine features a "Flavor Savor" device inside the drip coffee filter holder. This increases coffee infusion time to improve extraction. The resulting coffee has a full intense flavor.

- Press the DRIP COFFEE ON/OFF button (fig. 4). The ON indicator light on the button comes on and the appliance starts to make the coffee. (To make the coffee at the programmed time, press the AUTO button (fig. 3) and the AUTO light on the button comes on.
- Delivery of coffee will start after a few seconds.

It is completely normal for the appliance to release a little steam while the coffee is percolating.

To keep the coffee hot after percolation, place the carafe on the hot plate and leave the appliance on (drip coffee indicator on). The coffee in the carafe is kept at the right temperature.

- To turn the appliance off, press the DRIP COFFEE ON/OFF button.

HOW TO CHOOSE THE FLAVOR OF THE DRIP COFFEE

With the AccuFlavor System, the flavor of the drip coffee can be chosen according to personal taste. By turning the AccuFlavor selector knob (fig. 12), the coffee machine can be set for coffee with a strong (STRONG position) or light (LIGHT position) taste.

The AccuFlavor Selector changes the strength of the coffee.

HOW TO MAKE ESPRESSO

FILLING THE WATER TANK

Lift the cover and remove the water tank on the left (fig. 13) by pulling it upwards. Fill the tank with cold clean water. Replace the tank, pressing lightly to open the valve located on the bottom of the tank.

The tank can also be filled without removing it, pouring the water directly from a carafe.

Note: Never use the appliance without water in the tank. Always remember to add more water when the level drops to less than an inch from the bottom.

PREHEATING THE COFFEE UNIT

To obtain espresso at the right temperature, the coffee machine must be preheated. Turn the selector knob to the ☞ position (fig. 14) at least half an hour before making the espresso, making sure the filter holder is attached to the appliance (check that the steam knob is closed). To attach the filter holder, position it under the boiler outlet with the handle towards the left (fig. 15), push it upwards and at the same time rotate the handle towards the right. Rotate firmly. Wait for half an hour, then make the espresso as described in the following chapter.

Alternatively, preheating can be achieved more rapidly proceeding as follows:

1. Turn the appliance on by rotating the selector knob to the ☞ position (fig. 14) and attach the filter holder to the appliance without adding ground coffee.
2. Place a cup under the filter holder. Use the same cup as will be used to prepare the coffee in order to preheat it.
3. Wait for the OK indicator light to come on (fig. 16), then immediately rotate the selector knob to the ☞ position (fig. 17), run the water off until the OK indicator light goes out, then interrupt delivery by rotating the selector knob to the ☞ position (fig. 14).
4. Empty the cup. Wait until the OK indicator light comes on again then repeat the same operation. (It is normal for a small and harmless puff of steam to be given off when removing the filter holder).

HOW TO PREPARE ESPRESSO USING THE FILTER HOLDER FOR GROUND COFFEE

1. After preheating the appliance as described in the paragraph above, place the ground coffee filter in the filter holder, making sure the tab is correctly inserted in the housing as shown in fig. 18.
2. To prepare a single espresso, fill the filter with a level measure of ground coffee, about 7 grams (fig. 19). To prepare two coffees, use the filter and fill with two loosely filled measures of ground coffee (about 6+6 grams). Fill the filter a little at a time to prevent the ground coffee from overflowing.

IMPORTANT: For correct operation, before adding the ground coffee to the filter holder, clean the filter from residues of ground coffee from the previous infusion.

Note: Use top quality fine-ground coffee for espresso coffee machines.

3. Distribute the ground coffee evenly and press lightly with the tamper (fig. 20).

Note: Correct pressing of the ground coffee is essential to obtain a good espresso. If pressing is excessive, coffee delivery will be slow and the froth will be dark. If pressing is too light, coffee delivery will be too rapid and the froth will be thin and light colored.

4. Remove any excess coffee from the rim of the filter holder and attach the filter holder to the appliance. **Rotate firmly (fig. 15) to avoid leaks of water.**
5. Place the cup or cups (ideally preheated by rinsing with a little hot water) under the filter holder spouts (fig. 21).
6. Make sure the espresso OK indicator light (fig. 16) is on (if off, wait until it comes on), then select ☞ (fig. 17) until the required quantity is obtained. To interrupt, place the selector back in the ☞ position (fig. 14).

7. To remove the filter holder, rotate the handle from right to left.

IMPORTANT: To avoid splashes, never remove the filter holder while the appliance is delivering coffee.

8. To dispose of the used coffee, block the filter using the lever incorporated in the handle and empty the grounds by turning the filter holder upside down and tapping (fig. 22).

9. To turn the appliance off, rotate the selector knob to the "O" position (fig. 23)

IMPORTANT: The first time the appliance is used, all accessories the machine must be washed through by making at least five coffees without using ground coffee.

HOW TO MAKE ESPRESSO WITH THE FILTER HOLDER FOR PODS

1. Preheat the appliance as described in the paragraph "PREHEATING THE COFFEE UNIT". Leave the filter holder attached to the appliance. This obtains a hotter coffee. Preheating improves the filter holder gasket seal.

2. Press the filter holder button and insert a pod, centering it as far as possible above the filter (fig. 24).

Always follow the instructions on the pod pack to position the pod on the filter correctly.

NOTE: Use pods conforming to the ESE standard indicated on the pack with the following logo:



The ESE standard is a system accepted by leading pod producers and enables espresso to be prepared simply and cleanly.

3. Attach the filter holder to the appliance. **Always rotate as far as it will go (fig. 15).**

Note: To ensure effective closure and avoid leaks of water from the rim of the filter holder, you are recommended to grease the bottom of the lateral tabs from time to time with butter or oil (as shown in figure 25).

IMPORTANT: When using the filter holder for pods, after using the filter for ground coffee, remove any coffee grounds stuck to the boiler outlet (fig. 26). Failure to observe this precaution may lead to water leaking from the edges of the pod filter holder while the coffee is being prepared.

4. Proceed as in points 5, 6 and 7 in the previous paragraph.

5. To remove the pod, press the button on the filter holder and extract.

6. To turn the appliance off, rotate the selector knob to the "O" position (fig. 23).

HOW TO MAKE CAPPUCCINO

1. Prepare the espresso as described in the previous paragraphs, using sufficiently large cups.

2. Rotate the selector knob to the ☼ position (fig. 27). The steam indicator light ☼ comes on (fig. 27).

3. Wait until the OK indicator light comes on (fig. 28) indicating that the boiler has reached the ideal temperature for steam production.

4. In the meantime, fill a container with about 3.5 oz of milk for each cappuccino to be prepared. The milk must be at refrigerator temperature (not hot!). In choosing the size of the container, bear in mind that the milk increases in volume by 2 or 3 times.

NB: You are recommended to use skim milk at refrigerator temperature.

5. Remove the cappuccino maker by pulling forwards and rotating to the left (fig. 29). During this operation, avoid touching the boiler outlet as it is hot. Place the container containing the milk under the cappuccino frother.

6. Immerse the cappuccino maker in the milk for about 2 cm and rotate the steam knob counterclockwise (fig. 30) (rotating the knob more or less varies the quantity of steam discharged by the cappuccino maker). The milk now starts to increase in volume and take on a creamy appearance.

7. When the required temperature is reached (the ideal is 60°C -140°F), interrupt steam delivery by rotating the steam knob clockwise.

8. Pour the frothed milk into the cups containing the espresso prepared previously. The cappuccino is ready. Sweeten to taste and if desired, sprinkle the froth with a little cocoa powder.

Note: To prepare more than one cappuccino, first make all the coffees then at the end prepare the frothed milk for all the cappuccinos.

IMPORTANT: Always clean the cappuccino frother after use. Proceed as follows:

1. Immerse the cappuccino frother in about 3/4" milk inside the container and rotate the steam knob counter-clockwise (Fig.30).

2. With one hand, hold the top part stationary and with the other unscrew the cappuccino maker by rotating clockwise and extracting from the nozzle (fig. 31).

3. Remove the steam nozzle from the delivery tube.

4. Wash the cappuccino frother and steam nozzle thoroughly with warm water.

5. Make sure the two holes shown in fig. 32 are not blocked. If necessary, clean with a pin.
6. Replace the steam nozzle by inserting it in the steam tube, lining up arrow A and notch B shown in fig. 33.
7. Replace the cappuccino frother by inserting it as far as it will go into the steam nozzle, lining up arrow C and notch B as shown in figure 34 and then rotating counter-clockwise.

HOT WATER PRODUCTION

1. Turn the appliance on by rotating the selector knob to the  position (fig. 14).
2. Place a container under the cappuccino maker.
3. When the OK indicator light comes on, position the selector knob as shown (fig. 17) and at the same time, rotate the steam knob counter-clockwise (fig. 30). Hot water is delivered from the cappuccino frother;
4. To interrupt delivery of hot water, rotate the steam knob clockwise and position the selector knob to "O".

CLEANING AND MAINTENANCE

1. When cleaning the coffee machine, do not use solvents or abrasive detergents. A soft, damp cloth is sufficient.
2. Clean the filter holder cup, filters, drip tray and water tank regularly.

IMPORTANT: During cleaning, never immerse the coffee machine in water. It is an electrical appliance.

CLEANING THE FLAVOR SAVER

To facilitate cleaning of the Flavor Saver, it can be removed from the filter holder (R) by pulling it upwards (fig. 35). To replace, just slide the Flavour Saver into the guides on the inside edge of the drip coffee filter holder.

CLEANING THE FILTER HOLDER FOR GROUND COFFEE

About every 300 coffees, clean the filter holder for ground coffee as follows:

- Extract the filter with frother from the filter holder (fig. 36).
- Unscrew the cap of the frother by rotating in the direction indicated by the arrow on the cap (fig. 37). Remove the frother from the container by pushing it from the cap end (fig. 38).
- Remove the gasket and the metal filter (fig. 39).
- Rinse all components and clean the metal filter thoroughly in hot water using a brush (fig. 40). Check (inspecting against the light) that the holes in the metal filter are not blocked. If necessary, open them using a pin (fig. 41).
- Replace the filter and gasket on the plastic disk. Make sure to insert the pin on the plastic disk into the hole in the gasket (hole A in fig. 42).
- Replace the resulting assembly in the steel filter container

(fig. 43), making sure the pin is inserted into the hole in the support (hole B in fig. 43).

- Finally, screw on the cap.

Failure to clean as described above invalidates the warranty.

CLEANING THE POD FILTER HOLDER

About every 300 coffees, clean the filter holder for pods as follows:

- Push the filter holder button and remove the filter (fig. 44). Clean the inside of the filter holder. Never wash in a dishwasher.
- Clean the filter thoroughly in hot water using a brush. Make sure the holes in the metal filter are not blocked. If necessary, clean with a pin (see fig. 41).
- Replace the filter.

Failure to clean as described above invalidates the warranty.

CLEANING THE BOILER OUTLET



About every 300 coffees, the espresso boiler outlet must be cleaned as follows:



- Make sure the appliance is not hot and that it is unplugged from the outlet;
- Using a screwdriver, unscrew the screw fixing the espresso boiler outlet (fig. 45);
- Clean the boiler with a damp cloth (fig. 26);
- Clean the outlet thoroughly in hot water using a brush. Make sure the holes are not blocked. If necessary, clean with a pin.
- Continue to clean the boiler outlet while rinsing under the tap,
- Replace the boiler outlet.

Failure to clean as described above invalidates the warranty.

DESCALING THE ESPRESSO UNIT

You are recommended to descale the coffee machine about every 300 coffees. You should use a commercially available product specifically for descaling espresso coffee machines. If you cannot obtain such a product, you can also follow the procedure below.

1. Fill the espresso water tank with 1 litre of water.
2. Dissolve 2 spoonfuls (about 1 oz.) of citric acid;
3. Rotate the selector knob to the  position and wait until the OK indicator light comes on.
4. Make sure the filter holder is not attached and position a container under the outlet.
5. Rotate the selector knob to the  position (fig. 17) and run off half the solution in the tank. Then interrupt the flow by rotating the selector to the "O" position (fig. 23).
6. Leave the solution to work for about 15 minutes, then run off the rest of the water in the tank.
7. To eliminate residues of the solution and scale, rinse the tank well, fill with clean water and replace in its housing.

8. Rotate the selector knob to the  position and run off the water until the tank is completely empty;
9. Rotate the selector knob to the  position and repeat operations 7 and 8 again.

Repair of damage to the coffee machine caused by scale is not covered by the warranty unless descaling is performed regularly as described above.

DESCALING THE DRIP COFFEE UNIT

Over time, calcium in the water may cause obstructions, reducing the efficiency of the coffee machine.

The coffee machine has a system to monitor the quantity of scale. When the scale builds up excessively, the ON/OFF coffee indicator light starts flashing. This means the appliance should be descaled.

To descale, always use special commercially available descaling products for drip coffee machines. If these products are not available, you can also follow the procedure below.

1. Pour four cups of water into the carafe;
2. Dissolve two spoonfuls of citric acid (about 1 oz.) and pour the solution into the drip coffee water tank;
3. Place the carafe on the warming plate;
4. Press the drip coffee ON/OFF switch, percolate the equivalent of one cup and then switch off the appliance;
5. Leave the solution to work for 15 minutes. Repeat operations 4 and 5 again.
6. Turn the appliance on and run off the water until the tank is completely empty.
7. Rinse by operating the appliance with water only at least 3 times (3 complete tanks of water).

Failure to clean as described above invalidates the warranty.

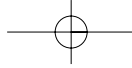

PROBLEM	POSSIBLE CAUSES	SOLUTION
The drip coffee takes longer to percolate	The drip coffee machine needs to be descaled	Perform the descaling procedure as described in the paragraph "Descaling the drip coffee unit".
The drip or espresso has an acidic flavor.	Inadequate rinsing after descaling	Rinse the appliance as described in the chapter "Descaling the drip coffee unit" or "Descaling the espresso unit".
The espresso is cold	The espresso OK indicator light was not on when the coffee was run off.	Wait until the espresso OK indicator light comes on
	The appliance was not preheated	Preheat as described in the paragraph "Preheating the espresso coffee unit".
	The cups were not preheated	Preheat the cups by rinsing with hot water
No espresso is delivered	No water in the tank	Fill the tank with water
	The holes in the filter holder spouts are blocked	Clean the spout holes
The espresso drips from the edges of the filter holder rather than the holes	The filter holder is inserted incorrectly	Attach the filter holder correctly and rotate as far as it will go.
	The espresso boiler gasket has lost elasticity	Have the espresso boiler gasket replaced at a De'Longhi service centre
	The filter holder spout holes are blocked	Clean the spout holes.
The pump is excessively noisy	The water tank is empty	Refill the tank
The espresso coffee froth is light coloured (the coffee is delivered from the spout too fast)	The ground coffee is inadequately pressed.	Press the ground coffee more firmly.
	The quantity of ground coffee is inadequate.	Increase the quantity of coffee
	The ground coffee is too coarse	Use only ground coffee for espresso coffee machines
The coffee froth is dark (the coffee is delivered by the spout too slowly)	<ul style="list-style-type: none"> • The ground coffee is pressed down too firmly • The quantity of coffee is excessive • The espresso boiler outlet is blocked • The ground coffee is too fine 	<ul style="list-style-type: none"> • Press the coffee down less firmly • Reduce the quantity of ground coffee • Clean as described in the chapter "Cleaning the espresso boiler outlet" • Use only ground coffee for espresso machines
No milk froth is formed when making cappuccino	<ul style="list-style-type: none"> • Milk not cold enough • Always use skim milk at refrigerator temperature. 	<ul style="list-style-type: none"> • Cappuccino maker dirty • Thoroughly clean the holes in the cappuccino maker as described in the paragraph "Cleaning the cappuccino maker".

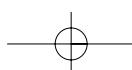
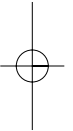
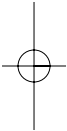



Limited Warranty

What Does This Warranty Cover? We warrant each appliance to be free from defects in material and workmanship. Our obligation under this warranty is limited to replacement or repair, free of charge at our factory or authorized service centers of any defective part or parts thereof other than parts damaged in transit, which shall be returned to us, transportation prepaid. Please be advised that any shipping cost for replacement items will be charged to the consumer.

This warranty shall apply only if the appliance is used in accordance with the factory directions which accompany it, and on an Alternating Current (AC) circuit.

How Long Does The Coverage Last? This warranty runs for one year from the date of delivery and applies only to the original purchaser for use.

What is not covered by the warranty? repairs or alterations to the appliance outside our factory or authorized service centers, nor shall it apply to any appliance which has been subject to abuse, misuse, negligence or accidents. Also, consequential and incidental damage resulting from the use of this product or arising out of any breach of contract or breach of this warranty are not recoverable under this warranty. Some states do not allow the exclusion or limitation of incidental or consequential damage, so the above limitation may not apply to you.

How Do You Get Service? If repairs become necessary or spare parts are needed, please contact:

De'Longhi America Inc.

Park 80 West Plaza One, 4th floor
Saddle Brook NJ 07663
or call Service Tel. No 1-800-322-3848
or visit our internet site:
www.delonghiusa.com

De' Longhi CANADA

6150 MCLAUGHLIN ROAD
MISSISSAUGA, ON
L5R 4E1

The above warranty is in lieu of all other express warranties and representations. All implied warranties are limited to the applicable warranty period set forth above. This limitation does not apply if you enter into an extended warranty with DeLonghi. Some states do not allow limitations on how long an implied warranty lasts, so the above exclusions may not apply to you. DeLonghi does not authorize any other person or company to assume for it any liability in connection with the sale or use of its appliance.

How Does State Law Apply? This warranty gives you specific legal rights, and you may also have other rights which vary from state to state.