

This Owner's Manual is provided and hosted by [Appliance Factory Parts](#).

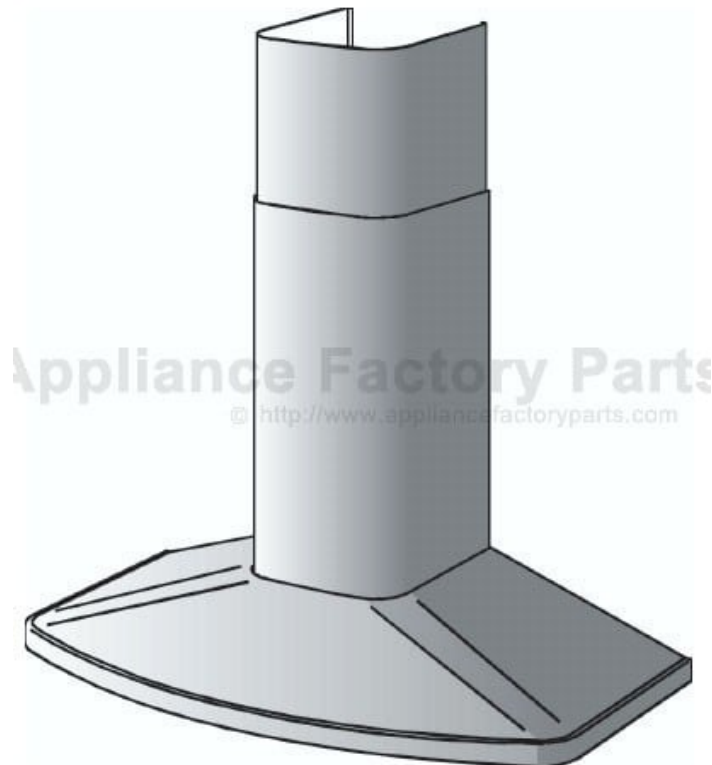

BROAN RM523004 Owner's Manual

[Shop genuine replacement parts for BROAN RM523004](#)



[Find Your BROAN HVAC Parts - Select From 1309 Models](#)

----- Manual continues below -----

RM52000 SERIES (RANGEMASTER®) by Broan-NuTone RANGE HOOD

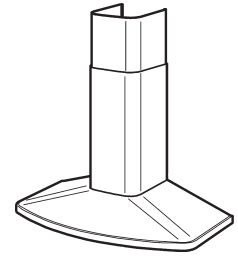

A wall-mounted chimney hood with sleek, graceful, hand-rolled curves that is engineered to meet the requirements of today's conventional appliance and kitchen styles.

FEATURES

- Professional style design
- 430 Stainless Steel #4 Brushed construction
- Wall mount installation
- Seamless corners for easy cleaning
- Ducted/non-ducted telescopic flue - fits 8 ft. to 9 ft. ceilings
- 6" round duct connector/backdraft damper
- 370 cfm centrifugal blower
- Three-speed slide control
- Dual halogen lighting (2 x 20 Watt, Type JC 12V 20W G4 Base - bulbs included)
- Dishwasher-safe aluminum filter features a quick-release latch and professional style appearance
- Available sizes: 30", 36", 42"
- Heat Sentry™ - automatically turns blower to high speed when excess cooking heat is detected

OPTIONS

- Replacement grease filters available
- Non-ducted recirculation kit (Model RRK51)
- Replacement charcoal filter (Model FILTERSQUARE)
- Flue Extension for 10 ft. ceiling Model RFX5204 (ducted applications), Model RFXN5204 (non-ducted applications) (35-1/16" long)

SPECIFICATIONS

VOLTS	AMPS	CFM	SONES	DUCT
120	2.63	370	7.0	6" round



Broan-NuTone LLC, 926 West State Street, Hartford, WI 53027 (1-800-637-1453)

NuTone, Inc., 4820 Red Bank Road, Cincinnati, OH 45227 (1-800-543-8687)

Broan-NuTone Canada, Inc., 1140 Tristar Drive, Mississauga, Ontario, L5T 1H9 (1-888-882-7626)

TYPICAL SPECIFICATION

Range hood shall be Broan Model RM52000.

Unit shall be convertible between ducted (using a washable aluminum filter) and non-ducted (using a recirculation kit).

Motor to be permanently lubricated.

Unit shall have three-speed fan switch and separate light switch.

Sides shall be mitered and bottom edge hemmed - with no sharp edges.

Air delivery shall be no less than 370 CFM.

Unit shall be U.L. and cUL listed.

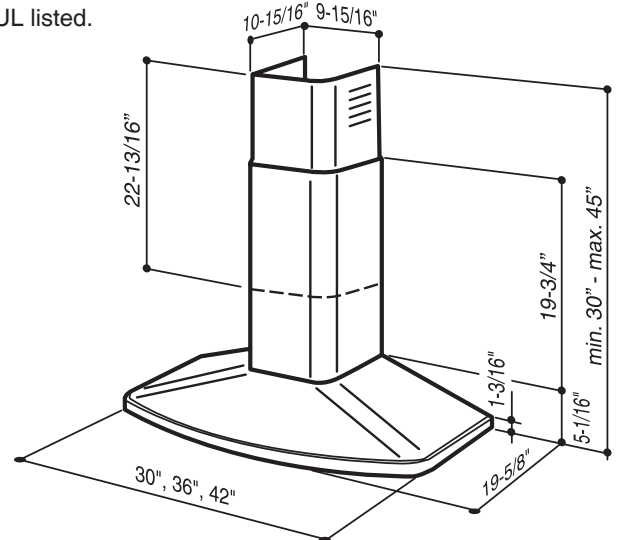

HVI-2100 CERTIFIED RATINGS comply with new testing technologies and procedures prescribed by the Home Ventilating Institute, for off-the-shelf products, as they are available to consumers. Product performance is rated at 0.1 in. static pressure, based on tests conducted in AMCA's state-of-the-art test laboratory. Sones are a measure of humanly-perceived loudness, based on laboratory measurements.

REFERENCE	QTY.	REMARKS	Project
			Location
			Architect
			Engineer
			Contractor
			Submitted by Date

RM52000 SERIES WIRING

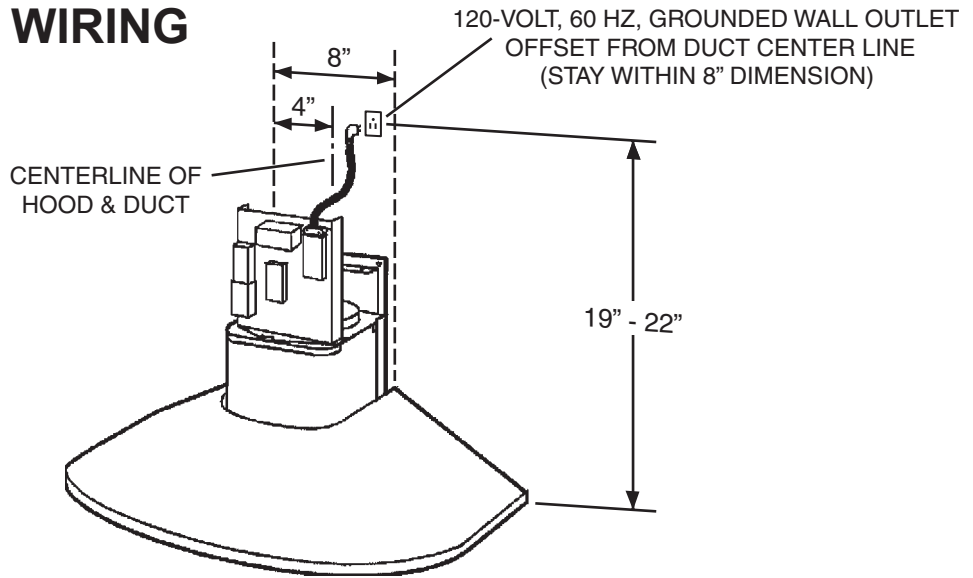

RM52000 SERIES MOUNTING

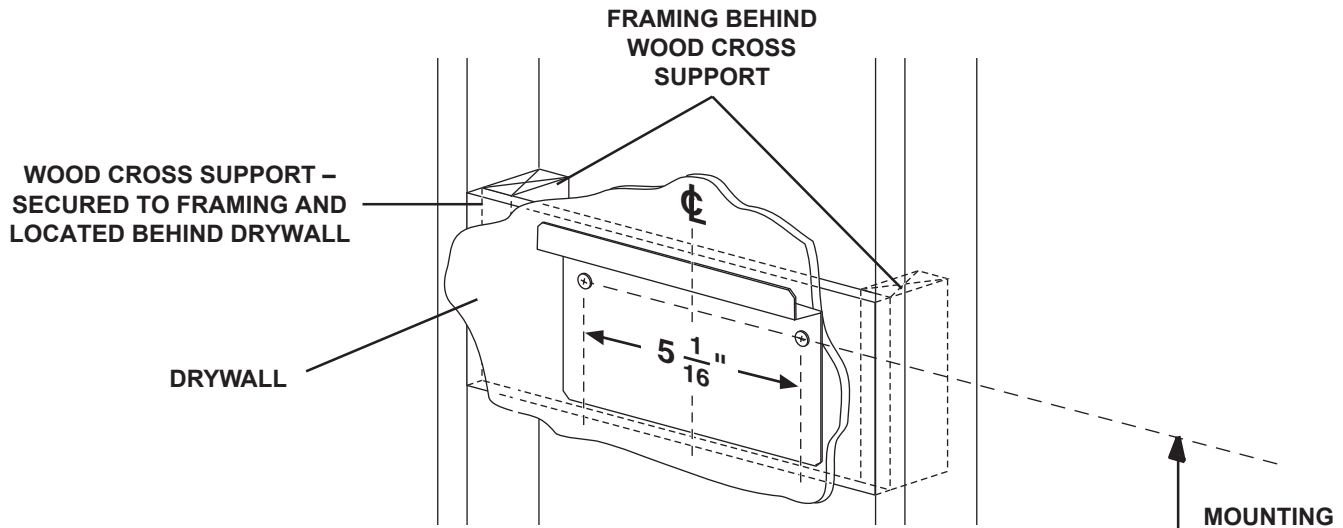

CEILING HEIGHT	DUCT METHOD	HOOD DISTANCE ABOVE 36" HIGH COOKTOP (SEE NOTE 1)						
		24"	25"	26"	27"	28"	29"	30"
		MOUNTING BRACKET LOCATION ABOVE 36" HIGH COOK TOP						
8 FEET	DUCTED	38"	39"	40"	41"	42"	43"	44"
	NONDUCTED	38"	39"	40"	41"			
9 FEET	DUCTED OR NONDUCTED				41"	42"	43"	44"
10 FEET	DUCTED OR NON-DUCTED (SEE NOTE 2)			40"	41"	42"	43"	44"

- NOTES:**
- Minimum hood distance above cooktop must not be less than 24".
A maximum of 30" above the cooktop is highly recommended for best capture of cooking impurities.
Distances over 30" above the cooktop are at the installer's and user's discretion - providing that ceiling height and flue length permit.
 - Requires optional 10-foot flue extension model RFX5204 (ducted) or RFXN5204 (non-ducted).



Broan-NuTone LLC, 926 West State Street, Hartford, WI 53027 (1-800-637-1453)
 NuTone, Inc., 4820 Red Bank Road, Cincinnati, OH 45227 (1-800-543-8687)
 Broan-NuTone Canada, Inc., 1140 Tristar Drive, Mississauga, Ontario, L5T 1H9 (1-888-882-7626)