

This Owner's Manual is provided and hosted by [Appliance Factory Parts](#).



WHIRLPOOL RC8700 Owner's Manual

[Shop genuine replacement parts for WHIRLPOOL
RC8700](#)



[Find Your WHIRLPOOL Electric Range Parts - Select From 63 Models](#)

----- Manual continues below -----



HOW TO MAKE A HOME RUN.™

Use And Care

G U I D E



A Note to You	2
Cooktop Safety	3-5
Getting to Know Your Cooktop	6
Controls	7
Using	7
Caring for	8
Coil Elements	9
Installing	9
Using	11
Caring for	13
Ceramic Surface Units	16
Installing	16
Using	18
Caring for	20
Grill	23
Installing	23
Using	25
Caring for	28
Griddle	30
Installing	30
Using	31
Caring for	33
Vent	34
Using	34
Caring for	35
Troubleshooting	36
Requesting Assistance or Service	38
Warranty	40

1-800-253-1301
Call us with questions or comments.

30" ELECTRIC MODULAR DOWNDRAFT COOKTOP

MODELS RC8720ED
RC8700ED

PART NO. 8111P467-60/9763400

A Note to You

Thank you for buying a WHIRLPOOL® appliance.

Because your life is getting busier and more complicated, WHIRLPOOL cooktops are easy to use, save time, and help you manage your home better. To ensure that you enjoy years of trouble-free operation, we developed this Use and Care Guide. It is full of valuable information about how to operate and maintain your appliance properly and safely. Please read it carefully.

Also, please complete and mail in the Product Registration Card provided with your appliance. The card helps us notify you about any new information on your appliance.

Please record your model's information.

Whenever you call to request service for your appliance, you need to know your complete model number and serial number. You can find this information on the model and serial number plate (see diagram on page 6 for location of plate).

Please also record the purchase date of your appliance and your dealer's name, address, and telephone number.

Model Number _____

Serial Number _____

Purchase Date _____

Dealer Name _____

Dealer Address _____

Dealer Phone _____

Keep this book and the sales slip together in a safe place for future reference.

**Our Consumer Assistance Center
number is toll-free 24 hours a day.**

1-800-253-1301

Cooktop Safety

Your safety is important to us.

This guide contains safety statements under warning symbols. Please pay special attention to these symbols and follow any instructions given. Here is a brief explanation of the use of the symbol.

⚠️ WARNING

This symbol alerts you to such dangers as fire, electrical shock, burns, and personal injury.

IMPORTANT SAFETY INSTRUCTIONS

⚠️ WARNING

To reduce the risk of fire, electrical shock, injury to persons, or damage when using the cooktop, follow basic precautions, including the following:

General

- Read all instructions before using the cooktop.
- Install or locate the cooktop only in accordance with the provided Installation Instructions. The cooktop must be installed by a qualified installer. The cooktop must be properly connected to electrical supply and grounded.
- CAUTION: Do not store things children might want above the cooktop. Children could be burned or injured while climbing on it.
- Do not leave children alone or unattended in area where the cooktop is in use. They should never be allowed to sit or stand on any part of the cooktop. They could be burned or injured.
- Do not operate the cooktop if it is damaged or not working properly.
- Do not use the cooktop for warming or heating the room. Persons could be burned or injured, or a fire could start.
- Use the cooktop only for its intended use as described in this manual.



- Do not touch surface units or areas near units. Surface units could be hot even though they are dark in color. Areas near surface units become hot enough to cause burns. During and after use, do not touch, or let clothing or other flammable materials contact surface units or areas near surface units until they have had sufficient time to cool.

continued on next page



- Do not wear loose or hanging garments when using the cooktop. They could ignite if they touch a hot surface unit and you could be burned.
- Use only dry pot holders. Moist or damp pot holders on hot surfaces could result in burns from steam. Do not let pot holder touch hot heating elements. Do not use a towel or bulky cloth for a pot holder. It could catch on fire.
- Do not heat unopened containers. They could explode. The hot contents could cause burns and container particles could cause injury.
- Do not store flammable materials on or near the cooktop. The fumes could create an explosion and/or fire hazard.

When using the cooktop

- Make sure the reflector bowls are in place during cooking. Cooking without reflector bowls could subject the wiring and components underneath them to damage.
- Do not line reflector bowls or grill basin with aluminum foil or other liners. Improper installation of these liners could result in a risk of electrical shock or fire.
- Do not cook on a broken cooktop. If cooktop should break, cleaning solutions and spillovers could

penetrate the broken cooktop and create a risk of electrical shock. Contact a qualified technician immediately.

- Select a pan with a flat bottom that is about the same size as the surface unit. If pan is smaller than the surface unit, some of the heating element will be exposed and could result in the igniting of clothing or pot holders. Correct pan size also improves cooking efficiency.
- Check to be sure glass cooking utensils are safe for use on the cooktop. Only certain types of glass, glass-ceramic, ceramic, earthenware, or other glazed utensils are suitable for cooktops without breaking due to the sudden change in temperature.
- Never leave surface units unattended at high heat settings. A boilover could result and cause smoking and greasy spillovers that could ignite.



- Turn pan handles inward, but not over other surface units. This will help reduce the chance of burns, igniting of flammable materials, and spills due to bumping of the pan.

Grease

- Grease is flammable. Do not allow grease to collect around cooktop. Wipe spillovers immediately.



- Do not use water on grease fires. Never pick up a flaming pan. Smother flaming pan by covering with a well-fitted lid, cookie sheet, or flat tray. Flaming grease outside of pan can be extinguished with baking soda or, if available, a multipurpose dry chemical or foam-type extinguisher.

Care and cleaning

- Clean cooktop with care. Some cleaners could produce noxious fumes if applied to a hot surface. If a wet paper towel is used to wipe spills on a hot cooking area, be careful to avoid steam burns.
- Do not soak removable heating elements in water. The element will be damaged and shock or fire could result.

- Do not repair or replace any part of the cooktop unless specifically recommended in this manual. All other servicing should be referred to a qualified technician.
- Disconnect the electrical supply before servicing the cooktop.
- Keep all switches off when unit is not in use.
- Clean only parts listed in this manual and use procedures recommended.
- This appliance has been tested for safe performance using conventional cookware. Do not use any devices or accessories that are not specifically recommended in this manual. Do not use eyelid covers for the surface units or stovetop grills. The use of devices or accessories that are not expressly recommended in this manual can create serious safety hazards, result in performance problems, and reduce the life of the components of the appliance.

– SAVE THESE INSTRUCTIONS –

Getting to Know Your Cooktop

This section contains captioned illustrations of your cooktop. Use them to become familiar with the location and appearance of all parts and features. To help you find information on specific parts and features quickly, page references are included.

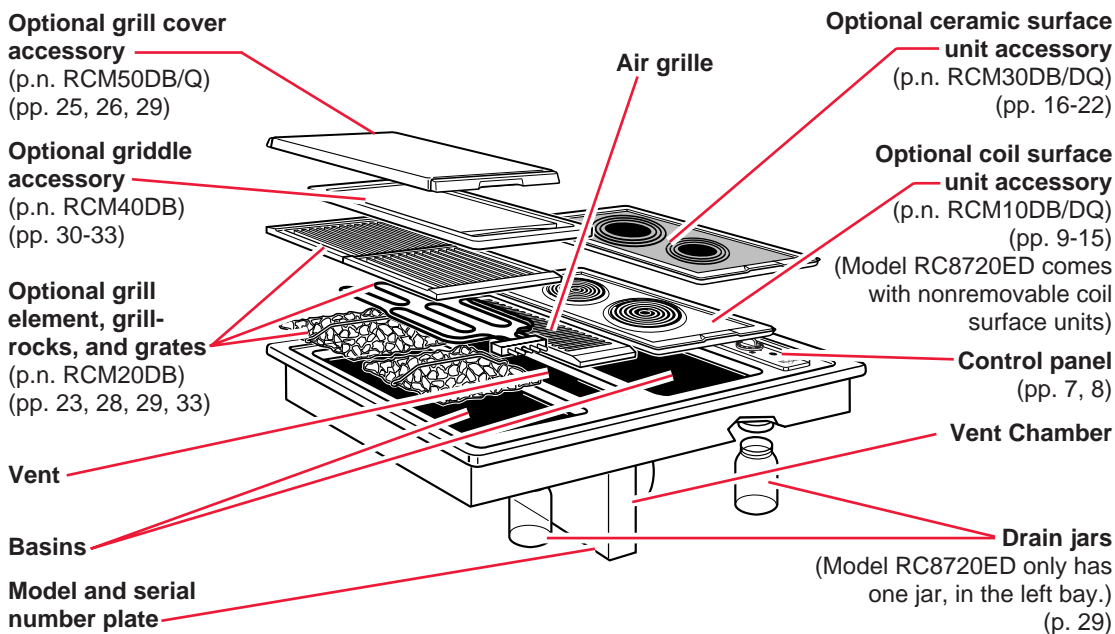

NOTE: Grill and griddle accessories can be installed in either basin on Model RC8700ED. Coil and ceramic surface unit accessories can be installed in both basins on Model RC8700ED. On Model RC8720ED, the right side has nonremovable coil surface units.

Control panel

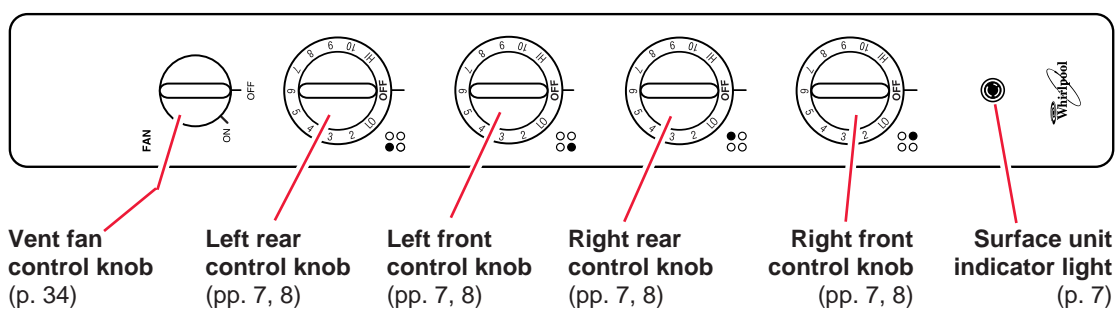

Controls

Using

Your cooktop's easy-to-use controls will work for all of the accessories. Please review this section before cooking with your cooktop to learn the few basics you'll need to use them correctly.

Turning the knobs

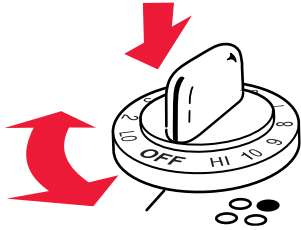

Push down on control knobs before turning them to a setting. You can set them anywhere between HI and LO.

NOTES:

- **When the knob is set** in any position, other than OFF, you can turn it in any direction without pushing down.
- **When using the grill element** (see pages 23-28), you can use either the whole grill area or only half the grill area. To use the whole area, turn on both the front and rear control knobs. To use half the area, turn on only one of the control knobs.

Surface unit indicator light

The Surface Unit Indicator Light on the control panel will glow when any surface unit/grill element control knob is on.

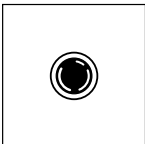

Until you get used to the settings, use the following as a guide for surface element cooking.

SETTING	RECOMMENDED USE
HI	<ul style="list-style-type: none">• To start foods cooking.• To bring liquids to a boil.
7-10	<ul style="list-style-type: none">• To hold a rapid boil.• To fry chicken.
5-6	<ul style="list-style-type: none">• Most frying, including pancakes.• To cook large amounts of vegetables.
3-4	<ul style="list-style-type: none">• For gravy, pudding, and icing.• To keep food cooking after starting it on a higher setting.
LO-2	<ul style="list-style-type: none">• To keep food warm until ready to serve.

! WARNING



Fire Hazard

Turn off all controls when done cooking.

Failure to do so can result in death, fire, or burns.

Caring for controls

NOTE: Let cooktop cool before cleaning.

Use this chart to help you clean your control knobs and panel.

PART	WHAT TO USE	HOW TO CLEAN
Control knobs	Sponge and warm, soapy water OR Dishwasher	<ul style="list-style-type: none"> • Turn knobs to OFF and pull straight away from control panel. • Wash, rinse, and dry well. Do not soak. • Do not use steel wool or gritty cleansers. They may damage the finish. • Replace knobs. Make sure all knobs point to OFF.
Control panel	Sponge and warm, soapy water OR Paper towel and mild liquid soap	<ul style="list-style-type: none"> • Wash, wipe with clean water, and dry well. • Do not use steel wool or gritty cleansers. They may damage the finish. • Do not spray cleaner directly on panel. Spray cleaner on paper towel.

Coil Elements

Installing

You can install extra coil elements in the left basin (Model RC8720ED) or both basins (Model RC8700ED) of your cooktop. To get the coil element accessory, order Part Number RCM10DB/DQ from a Whirlpool service company or dealer (see Step 2 on page 38) or call the Whirlpool Consumer Assistance Center toll-free **1-800-253-1301**.

To install:

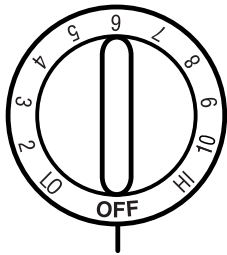

1. **Make sure** the control knobs are turned off.

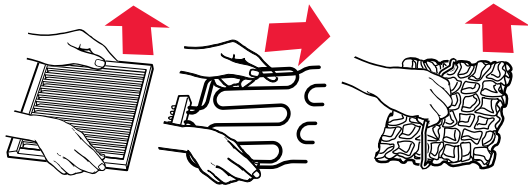

2. If the grill grates, element, and grill-rocks are in place, **remove** them before installing coil elements. **Clean out** any grease that may be in the basin. (See page 24 for more information.)

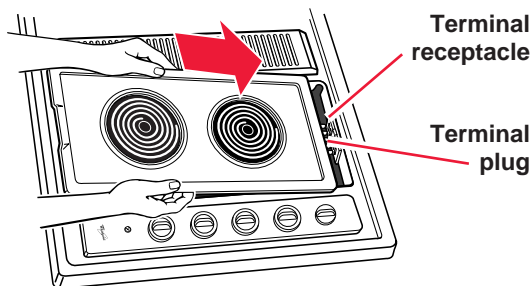

3. **Position** the accessory terminal plug towards the terminal receptacle.

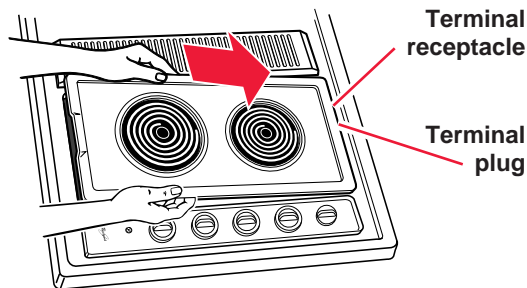

4. **Slide** the accessory towards the receptacle until the terminal plug is firmly set in receptacle.

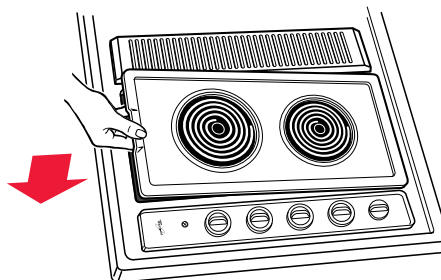

5. **Lower** the opposite end of the accessory into the cooktop until it is flush with the surface.

continued on next page

COIL ELEMENTS

To remove:

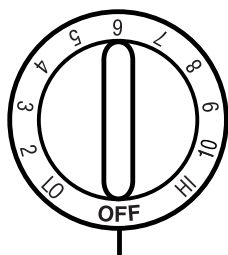

1. **Make sure** the control knobs are turned off and the cooktop is cool.

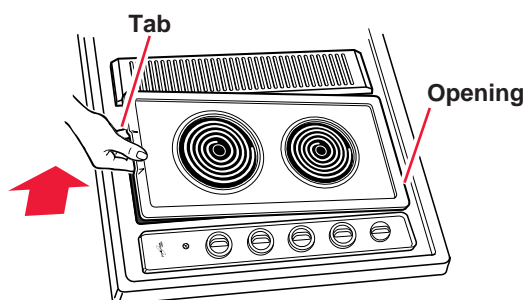

2. **Lift up** on the "tab" located on the accessory until the top of the accessory clears the opening of the cooktop by about two inches. Lifting the accessory too high while still set firmly in receptacle could damage the terminal plug.

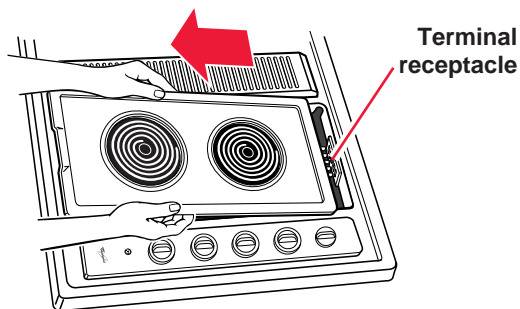

3. To pull out the accessory, **hold** it by the sides and **slide away** from the terminal receptacle. **Lift out** when fully unplugged.

NOTE: Do not stack accessories where they may fall or be damaged.

Using

Cookware tips

- **Select a pan** that is about the same size as the surface unit.



- **NOTE: For best results and greater energy efficiency**, use only flat-bottomed cookware that makes good contact with the surface units. Cookware with rounded, warped, ribbed (such as some porcelain enamelware), or dented bottoms could cause severe overheating, which damages the cookware and/or surface unit.

You can, however, use the newer cookware available with slightly indented bottoms or very small expansion channels. This cookware is specially designed to provide the good contact needed for best cooking results.

Also, woks, canners, and teakettles with flat bottoms suitable for use on your cooktop are now available in most stores that sell housewares.

- **The pan** should have straight sides and a tight-fitting lid.
- **Choose medium to heavy gauge** (thickness) pans that are fairly lightweight.
- **The pan material** (metal or glass) affects how fast heat transfers from the surface unit through the pan material and how evenly heat spreads over the pan bottom. Choose pans that provide the best cooking results.
- **Handles** should be made of sturdy, heat-resistant material and be securely attached to the pan.

NOTES:

- **If a surface unit** stays red for a long time, the bottom of the pan is not flat enough or is too small for the surface unit, or the control has been left on HI after boiling. Prolonged usage of utensils that are too large could result in damage to the surface unit, cooktop, wiring, and surrounding areas. To prevent damage, use correct utensils and turn control down to continue cooking.
- **Do not leave** an empty utensil, or one which has boiled dry, on a hot surface unit. The utensil could overheat and damage the utensil or surface unit.

Home canning information

To protect your cooktop:

- **Use flat-bottomed canners/pans** for best results.
- **Use the largest surface unit** for best results. Also, use a canner/pan which can be centered over the surface unit and which does not extend more than one inch outside surface unit area. Large diameter canners/pans, if not properly centered, trap heat and can cause damage to the cooktop.



- **Do not place canner** on two surface units at the same time. Too much heat will build up and will damage the cooktop.
- **Start with hot water.** This reduces the time the control is set on high. Reduce heat setting to lowest position needed to keep water boiling.
- **Keep reflector bowls clean** for best heat reflection.
- To prolong the life of the elements:
 - **Prepare small batches** at a time.
 - **Do not use elements** for canning all day.
- **Refer** to your canner manual for specific instructions.

Energy saving tips

Although the energy used for cooking is usually a very small percentage of the total energy used in the home, cooking energy can be used efficiently. Here are some tips to help you save energy when using your cooking product:

- **Use** pans with flat bottoms, straight sides, and tight-fitting lids.
- **Match** the pan to the surface unit size.
- **Cook** with a minimum of liquid or fat to help shorten cooking time.
- **Preheat** pans only when recommended and for the shortest time possible.
- **Start** food on higher heat settings, then set surface unit control on low or off to finish cooking. Use retained heat for cooking when possible.
- **Turn on** the surface unit only after placing filled pan on the unit.
- **Plan** your meals for the most efficient use of the cooktop.

Caring for coil elements

Your coil element cooktop is designed for easy care. You can do most cleaning with items found around your home. Cleaning your coil element cooktop whenever spills or soiling occurs will help to keep it looking and working like new.

NOTE: Let cooktop cool before cleaning.

Removing elements and reflector bowls

Removing

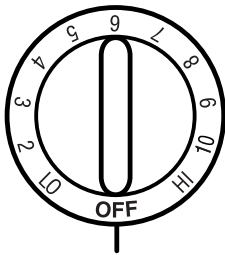

- 1. Make sure** all surface units are off and cool before removing surface units and reflector bowls.

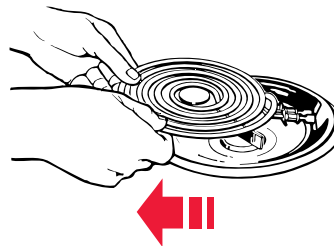

- 3. Pull** the surface unit straight away from the receptacle.

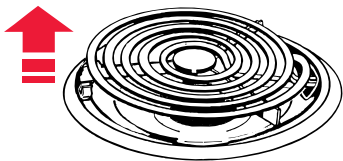

- 2. Lift** the edge of the unit, opposite the receptacle, just enough to clear the reflector bowl.



- 4. Lift out** the reflector bowl. See "Cleaning chart" on page 15 for cleaning instructions.

Replacing

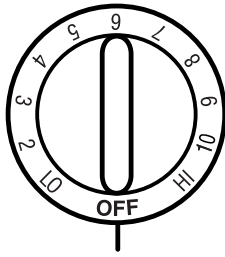

1. **Make sure** all surface units are off and cool before replacing surface units and reflector bowls.

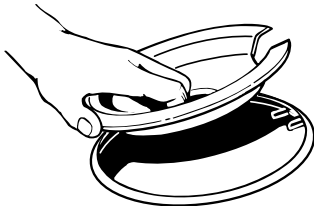

2. **Line up** openings in the reflector bowl with the surface unit receptacle.

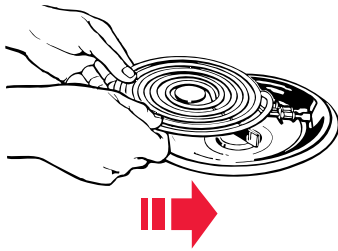

3. **Hold** the surface unit as level as possible with the terminal just started into the receptacle. **Push** the surface unit terminal into the receptacle.

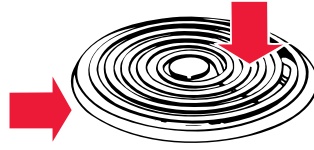

4. **While terminal is pushed into the receptacle as far as it will go, push down** the edge of the surface unit opposite the receptacle.

NOTE: Reflector bowls reflect heat back to the utensils on the surface units. They also help catch spills. When they are kept clean, they reflect heat better and look new longer.

If a reflector bowl gets discolored, some of your utensils may not be flat enough, or some may be too large for the surface unit. In either case, some of the heat that's meant to go into or around a utensil goes down and heats the reflector bowl. This extra heat can discolor it.

Cleaning chart

Use this chart to clean all parts of your coil element cooktop.

PART	WHAT TO USE	HOW TO CLEAN
Surface units	No cleaning required	<ul style="list-style-type: none"> • Spatters or spills will burn off. • Do not immerse in water.
Chrome reflector bowls	Warm, soapy water and a nonabrasive, plastic scrubbing pad	<ul style="list-style-type: none"> • Wash, rinse, and dry well. • Clean often. • Do not use gritty or harsh cleansers.
Exterior surfaces (other than control panel)/area under cooktop	Sponge and warm, soapy water	<ul style="list-style-type: none"> • Wash, wipe with clean water, and dry well. • Use nonabrasive, plastic scrubbing pad on heavily soiled areas. • Do not use gritty or harsh cleansers. They may damage the finish. <p>NOTE: Do not allow foods containing acids (such as vinegar, tomato, or lemon juice) to remain on surface. Acids may remove the glossy finish. Also wipe up milk or egg spills when cooktop is cool.</p>

NOTE: Never immerse the cartridge in water to clean. This can damage wiring. A drain hole within the cartridge permits drainage of normal spills into the porcelain basin pan where it will drain into the grease container. If needed, you can wipe the bottom of the cartridge clean with detergent solution.

Ceramic Surface Units

Installing

You can install ceramic surface units in the left basin (Model RC8720ED) or both basins (Model RC8700ED) of your cooktop.

NOTE: The pictures in this section show the ceramic surface unit installed in the left basin, where the receptacle is in the front wall of the basin. To get the ceramic surface unit accessory, order Part Number RCM30DB/DQ from a Whirlpool service company or dealer (see Step 2 on page 38) or call the Whirlpool Consumer Assistance Center toll-free **1-800-253-1301**.

To install:

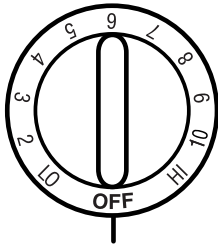

1. **Make sure** the control knobs are turned off.

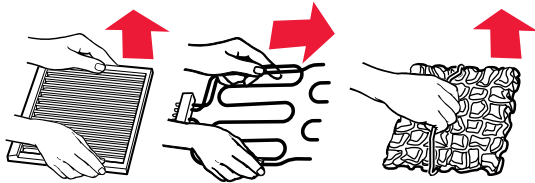

2. If the grill grates, element, and grill-rocks are in place, **remove** them before installing ceramic surface units. **Clean out** any grease that may be in the basin. (See page 24 for more information.)

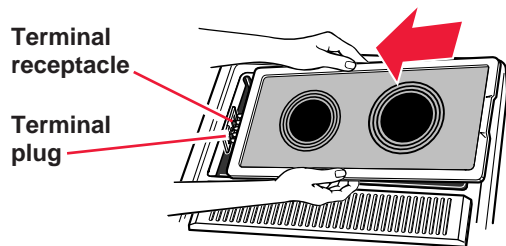

3. **Position** the accessory terminal plug towards the terminal receptacle.

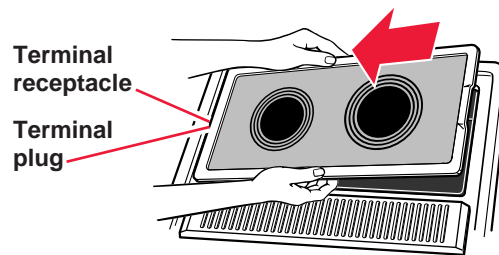

4. **Slide** the accessory towards the receptacle until the terminal plug is firmly set in receptacle.

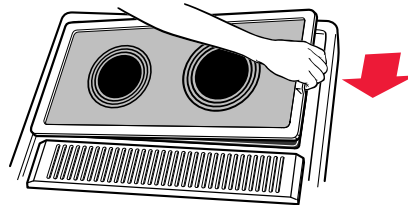

5. **Lower** the opposite end of the accessory into the cooktop until it is flush with the surface.

To remove:

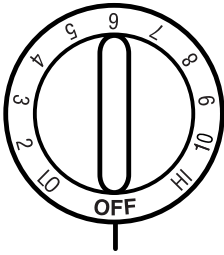

1. **Make sure** the control knobs are turned off and the cooktop is cool.

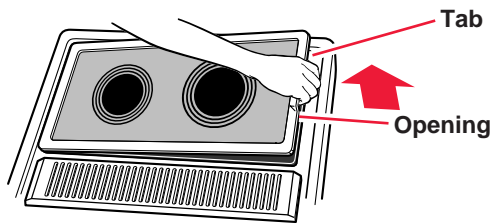

2. **Lift up** on the “tab” located on the accessory until the top of the accessory clears the opening of the cooktop by about two inches. Lifting the accessory too high while still set firmly in receptacle could damage the terminal plug.

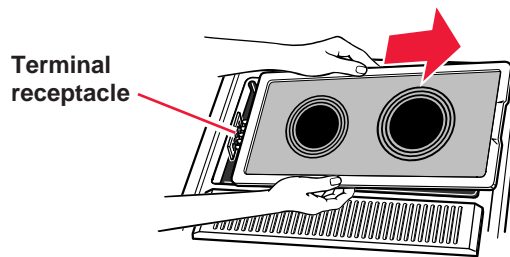

3. To pull out of the terminal, **hold** accessory by the sides and **slide away** from the terminal receptacle. **Lift out** when fully unplugged.

NOTE: Do not stack accessories where they may fall or be damaged. Never store other materials on top of a glass-ceramic accessory since this could damage or mar the surface.

Using

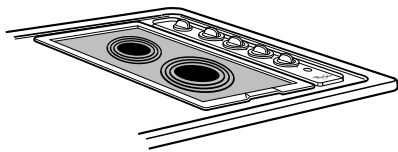

Cooking on the ceramic glass cooktop is almost the same as cooking on coil surface units. There are, however, a few differences:

- **The surface unit will glow red** when it is turned on. You will see the element cycling on (glowing red) and off – even on HI setting – to maintain the proper temperature setting you have selected.
- **Sliding metal pans** on ceramic glass cooktop surface could leave marks. Wiping off the cooktop before and after each use will help keep the surface free from stains and provide the most even heating. See pages 20-22 for care and cleaning suggestions.
- **When preparing foods** which can be easily scorched or over-cooked, start cooking at a lower temperature setting and gradually increase temperature as needed.
- **Do not use or place** plastic items anywhere on the cooktop.

Cookware tips

- **Select a pan** that is about the same size as the surface unit.



- **NOTE: For best results and greater energy efficiency**, use only flat-bottomed cookware that makes good contact with the surface units. Cookware with rounded, warped, ribbed (such as some porcelain enamelware), or dented bottoms could cause uneven heating and poor cooking results.

Also, woks, canners, and teakettles with flat bottoms suitable for use on your cooktop are now available in most stores that sell housewares.

- **The pan** should have straight sides and a tight-fitting lid.
- **Choose medium to heavy gauge** (thickness) pans that are fairly lightweight.
- **The pan material** (metal or glass) affects how fast heat transfers from the surface unit through the pan material and how evenly heat spreads over the pan bottom. Choose pans that provide the best cooking results.
- **Handles** should be made of sturdy, heat-resistant material and be securely attached to the pan.
- **With your hand**, feel the bottom of your pans while they are cool for nicks and scratches. Nicks and scratches on pan bottoms will scratch the ceramic glass cooktop.
- **Make sure bottoms** of pans are clean and dry before using on cooktop.
- **Avoid spillovers** on cooktop. Use pans with tall sides.
- **Do not** cook food directly on cooktop.

NOTE: Do not leave an empty utensil, or one which has boiled dry, on a hot surface unit. The utensil could overheat and damage the utensil or surface unit.

Home canning information

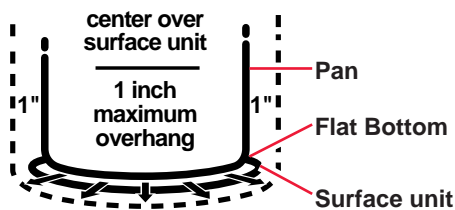

- **Acceptable** canning pots should not be oversized and must have a flat bottom.
- **Use the largest surface unit** for best results. Also, use a canner/pan which can be centered over the surface unit.
- **Start with hot water.** This reduces the time the control is set on high. Reduce heat setting to lowest position needed to keep water boiling.
- **Refer** to your canner manual for specific instructions.

Energy saving tips

Although the energy used for cooking is usually a very small percentage of the total energy used in the home, cooking energy can be used efficiently. Here are some tips to help you save energy when using your cooking product:

- **Use** pans with flat bottoms, straight sides, and tight-fitting lids.
- **Match** the pan to the surface unit size.
- **Cook** with a minimum of liquid or fat to help shorten cooking time.
- **Preheat** pans only when recommended and for the shortest time possible.
- **Start** food on higher heat settings, then set surface unit control on low or off to finish cooking. Use retained heat for cooking when possible.
- **Turn on** the surface unit only after placing filled pan on the unit.
- **Plan** your meals for the most efficient use of the cooktop.

Caring for ceramic surface units

This cooktop is designed for easy care. However, ceramic cooktops need to be maintained differently than standard electric open-coil elements. Foods spilled directly on the cooktop will not burn off as on open-coil elements. Because of this, the surface should be dust free and soil free before heating.

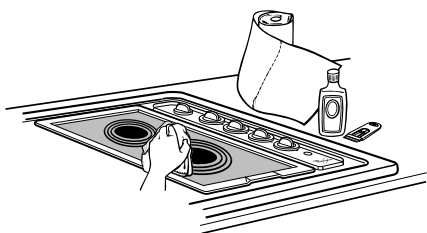

Your cooktop has been prepolished at the factory for improved protection and cleanability. The Cooktop Polishing Creme (see ordering information on page 21), a razor scraper, and paper towels or a sponge are all you need to clean your cooktop. For proper cleaning methods, please review "Cleaning tips" on pages 21. Follow them after each use to ensure top performance and to preserve that uniquely elegant look.

To avoid damaging the cooktop, follow these instructions:

- **Sugar spills and soils** (such as jellies and candy syrups) can cause pitting on the cooktop if not removed **while the ceramic surface is still warm**. Remove as soon as possible after the spill occurs.
- **Do not use** the cooktop as a cutting board.
- **Do not allow** anything that could melt (such as plastic or aluminum foil) to come in contact with the surface while it is hot.
- **Do not use** the ceramic cooktop to cook popcorn that comes in prepackaged aluminum containers. The container could leave aluminum marks on the cooktop that cannot be removed completely.
- **Do not use** steel wool, plastic cleaning pads, abrasive, powdered cleansers, chlorine bleach, rust remover, ammonia, or glass cleaning products with ammonia. These could damage the cooktop surface.
- **Dropping** heavy or hard objects on the cooktop could crack it. Be careful with heavy skillets. Do not store jars or cans above the cooktop.

Cleaning tips

What to use:

- **Cooktop Polishing Creme with paper towel or clean, damp sponge** – This creme has been developed especially for cleaning and protecting your cooktop. When using, follow instructions on container.
- **Razor scraper** – Use to remove cooked-on soils from your ceramic cooktop. To avoid scratches, keep the razor blade as flat against the cooktop as possible. **Store razor blades out of reach of children.**

Steps to follow:

1. **Most spills** can be wiped off easily using a paper towel or clean, damp sponge as soon as Surface Unit Indicator Light(s) goes off and cooktop is cool.
2. **For stubborn spills**, rub Cooktop Polishing Creme into cooked-on soil using a paper towel. If some soil remains, leave some creme on the spot(s) and follow Step 3.
3. **Carefully scrape** spots with the razor scraper.
4. **Finish** by polishing entire cooktop with Cooktop Polishing Creme and a paper towel.

To obtain order information for Cooktop Polishing Creme (Part No. 3184477) or razor scraper (Part No. 3183488), write to:

Whirlpool Corporation
 Attention: Customer Service Dept.
 1900 Whirlpool Drive
 LaPorte, IN 46350

OR

Call **1-800-253-1301** to order. You must have a major credit card to order by phone.

How to keep your cooktop looking like new:

IF THERE ARE	WHAT TO DO
Sugary spills and soils (such as jellies and candy syrups)	To prevent pitting on the cooktop, carefully use a single-edge razor blade held with a pot holder to scrape the melted material or sugary boilover to a cooler area of the cooktop. Use several layers of paper towels to wipe up the spillover, being careful not to burn yourself. When the element has cooled, use the razor blade to scrape off the remaining soil.
Dark streaks, specks, and discoloration	Use Cooktop Polishing Creme or nonabrasive cleanser with damp paper towel or sponge.
Metal marks (from copper or aluminum pans)	Use Cooktop Polishing Creme or nonabrasive cleanser with damp paper towel or sponge before heating the cooktop again. If heated before cleaning, metal marks may not come off.
Tiny scratches or abrasions	Scratches and abrasions do not affect cooking. In time, they will become less visible as a result of cleaning. To prevent scratches and abrasions, use Cooktop Polishing Creme regularly.

NOTE: Always wipe with clean water and dry your cooktop thoroughly after using cleanser to prevent streaking or staining.

Cleaning chart

PART	WHAT TO USE	HOW TO CLEAN
Exterior surfaces (other than control panel and cooktop)/ area under cooktop	Sponge and warm, soapy water	<ul style="list-style-type: none">• Wash, wipe with clean water, and dry well.• Use nonabrasive, plastic scrubbing pad on heavily soiled areas.• Do not use gritty or harsh cleansers. They may damage the finish. <p>NOTE: Do not allow foods containing acids (such as vinegar, tomato, or lemon juice) to remain on surface. Acids may remove the glossy finish. Also, wipe up milk or egg spills when cooktop is cool.</p>

Grill

Installing

The grill is made up of two black grill grates, a grill element, and two grill-rocks. To get the grill accessory, order Part Number RCM20DB from a Whirlpool service company or dealer (see Step 2 on page 38) or call the Whirlpool Consumer Assistance Center toll-free 1-800-253-1301.

To install:

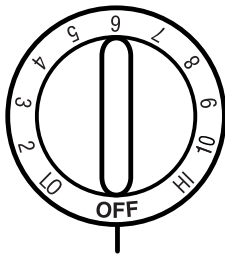

1. **Make sure** the control knobs are turned off.

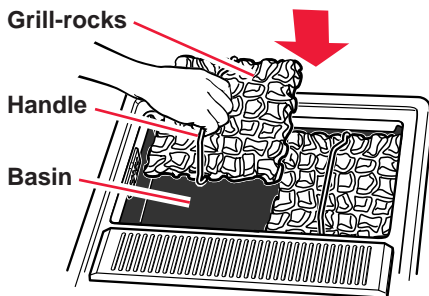

2. **Place the two grill-rocks in the basin.** The basin must be empty. The grill-rock handles must run parallel to the front of the cooktop. You have to use the grill-rocks because they hold up the grill element.

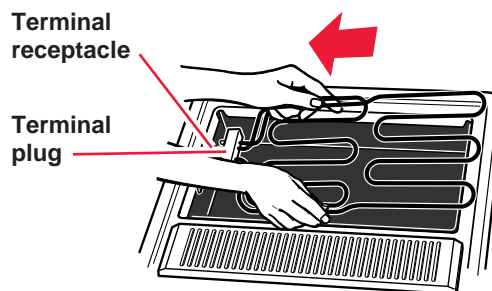

3. **Position** the grill element with the terminal plug towards the terminal receptacle. **Slide** the element towards the receptacle until the terminal plug is all the way inside it. The grill element should rest on the handles of the grill-rocks.

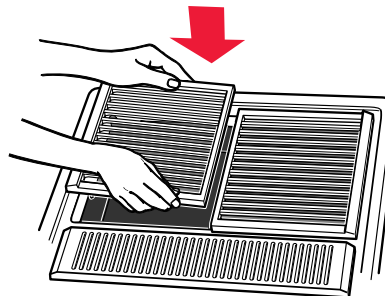

4. **Place** the grill grates on the top of the cooktop.

continued on next page

To remove:

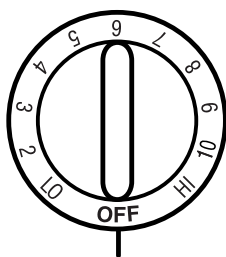

1. **Make sure** the control knobs are turned off and the grill is cool.

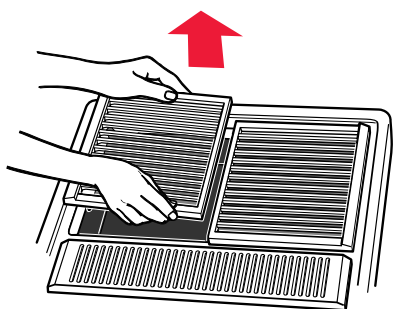

2. Remove the grill grates.

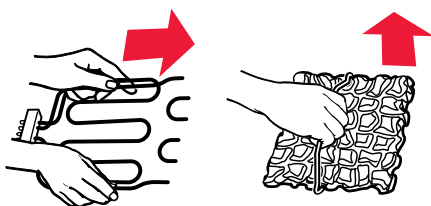

3. **Pull** the grill element away from the receptacle until it is unplugged. **Remove** the grill-rocks.

NOTE: Lifting the element too high while the plug is still in the receptacle could damage the plug.

Using

Before you use the grill for the first time:

1. **Wash** with warm, soapy water. **Rinse and dry.** Never use a metal scrubbing pad or gritty cleanser on the grill; these will damage the nonstick surface.
2. **After cleaning, lightly wipe** the cooking surface with cooking oil. This will prevent the food from sticking.

Grilling tips

Choosing meat

- **For best results,** buy top grade meat. Meat that is at least $\frac{3}{4}$ " thick will grill better than thinner cuts.

Preparing to grill

- **Meat** that usually has a lot of fat will smoke more when cooking and could cause flare-ups. However, fatty meat cooks faster than lean meat. Trim fat from meat before placing on the grill to prevent a large amount of smoke or flare-ups.
- **Remove** the grill cover before heating the grill. Because a heated grill cover would not look hot, someone could be burned if they touched the cover. Heating the grill cover could also damage the finish.
- **Precondition** grates by brushing them with vegetable oil or spraying them with a nonstick coating prior to each use.
- **Score** fat on the edges of steak, but do not cut into the meat. This will prevent curling while cooking.
- **Preheat** the grill on the HI setting for five or ten minutes. Preheating makes meat taste and look better. It also lets you quickly sear the meat to help keep juices in.
- **The fan** turns on by itself while you are using the grill. Do not use the grill if the fan does not go on.

- **Do not cover** the entire cooking surface with meat. Leave space between the food items to help smoke and steam clear away quickly.

What to use while grilling

- **Use** tongs with long handles or spatulas for turning meats. Do not use forks because they make holes in the meat, letting juices run out.

What not to use in the grill area

- **Do not use** aluminum foil.
- **Do not use** charcoal or wood chips.

While cooking

- **Before turning, let** one side of meat cook until it is as done as you want, or cook until juices appear on the top of the meat. Turn steaks and hamburgers just once; turning and moving food causes it to lose juice.
- **When basting** meats or putting sauces on food, remember that extra sauce winds up inside your grill and does not improve the food's flavor. Put on sauces during the last 15-20 minutes of cooking unless the recipe tells you to do it differently. If you put on too much of a sugary sauce, it will leave a caramel-like glaze on the grill grates and grill-rocks. This glaze is hard to clean.
- **There are many** meat marinades which will help make less expensive cuts of meat tender for cooking on the grill.
- **Some foods,** such as poultry and nonoily fish, may need some extra fat. Brush with oil or melted butter from time to time while grilling.
- **To help keep** juices in meat, salt after turning meat or after cooking is done.

continued on next page

Grilling tips (continued)

- **If meat begins** to cook too quickly, turn the grill control knob to a lower setting.
- **Grease drippings** will ignite occasionally to produce harmless puffs of flame for a second or two. This is normal while cooking. If you have too many flare-ups: you need to clean the grill interior, you have not trimmed the meat properly, or there is too much fat in the meat.
- **The grill element** should glow a bright cherry red.

What not to do while cooking

- **Do not let** optional grill-rocks become overloaded with grease. **Clean after each use.**
- **Do not leave** the optional grill while it is cooking.

After grilling

- **Clean** the basin area after each use. Do not allow the area under the grill to become overloaded with grease.
- **If grilled foods** are done cooking before you are ready to serve them, turn the control knob to a low setting. Cover meat with a single sheet of foil. Food will continue to cook.
- **Do not place** the grill cover over a heated grill. Let the grill cool before putting the cover in place.

NOTES:

- **Do not set** utensils or other items that could cause scratches on the grill cover. Do not set very hot containers on the cover or handles, since these could mar or change the color of the cover.
- **Use** the cover over the grill grates or griddle only. Do not place the cover over the coil or ceramic surface units.

! WARNING



Fire Hazard

Grease can cause large flare-ups.

To put out fire:

Make sure vent system has been switched on.

Turn grill control off, cover grill with large metal pan, and remove food from grill.

Do not put water on a grease fire.

To prevent fire and burns:

Do not use pots or pans on grill. They will become very hot.

Failure to follow the above can result in death, fire, or burns.

NOTES:

- **Use only** nylon or plastic utensils. The use of metal utensils could scratch the nonstick coating.
- **When using** nylon or plastic utensils, do not leave them on the grill. They could melt.

Grill chart

Preheat on HI for 5 or 10 minutes for best flavor. Cooking times and control settings are approximate due to differences in meats and electrical voltage. Use the following

chart as a guide to determine which cooking times and settings work best for you. You may need to adjust the cooking times to get the taste and/or doneness you want.

FOOD	SETTING	COOKING TIME (in minutes)	COMMENTS
Steak (½-¾")			
• Rare	HI	9-12	Turn after half the time.
• Medium	HI	12-19	Turn after half the time.
• Well-done	HI	16-23	Turn after half the time.
Steak (1-1¼")			
• Rare	HI	10-17	Turn after half the time.
• Medium	HI	19-26	Turn after half the time.
• Well-done	HI	24-32	Turn after half the time.
Hamburgers (3-4 oz)	10	15-25	Turn after half the time.
Pork chops (½-¾")	10	30-40	Turn occasionally.
Fully-cooked smoked pork chops	HI	10-15	Turn once.
Ham slices (½")	10	15-20	Turn once.
Fully-cooked sausages			
• Hot dogs, brats	HI	5-10	Turn occasionally.
• Polish	HI	10-20	Turn once.
Fresh sausage			
• Links	10	10-15	Turn occasionally.
• Patties (2½" diameter)	10	15-20	Turn occasionally.
• Italian sausage	10	25-35	Pierce casing with a fork. Turn once.
Lamb chops	10	25-35	Turn occasionally. Brush with glaze, if desired.
Chicken			
• Boneless breasts	10	25-35	Turn occasionally.
• Pieces, bone-in	10	45-60	Turn occasionally. Brush with marinade or glaze during last 10 minutes.

continued on next page

FOOD	SETTING	COOKING TIME (in minutes)	COMMENTS
Fish			
• Steaks (1")	10	20-30	Brush with butter. Turn after half the time.
• Fillets (½") (with skin on)	10	10-15	Start skin side down. Brush with butter. Turn after half the time.
• Shrimp (skewered)	10	8-12	Turn and brush with butter or marinade often.
Garlic bread	HI	2-4	Turn after half the time.
Hot dog and hamburger buns	10	2-3	

Caring for grill

NOTE: Let cooktop cool before cleaning.

Cleaning your grill whenever spills or soiling occurs will help to keep it looking and working like new.

PART	WHAT TO USE	HOW TO CLEAN
Grates	Warm, soapy water and a nonabrasive plastic scrubbing pad OR Dishwasher	<ul style="list-style-type: none"> • Wash, rinse, and dry well. • For heavy soil soak in hot, soapy water mixed with a cleanser, such as household ammonia. <p>NOTE: Do not use metal brushes, abrasive scouring pads, or other scrubbers made to clean outdoor grills. These will remove the finish as well as scratch the grates. Do not clean in a self-cleaning oven or use oven cleaners.</p>

PART	WHAT TO USE	HOW TO CLEAN
Grill-rocks	Warm, soapy water and a nonabrasive plastic scrubbing pad OR Dishwasher Bristle brush Oven cleaner	<ul style="list-style-type: none"> • Wash, rinse, and dry well. Clean often or after any large build-up of grease. You can wash grill-rocks in a dishwasher instead if you have first removed burned-on soil. • For heavy soil, soak in hot, soapy water mixed with cleanser, such as household ammonia. • Stubborn spots, such as burned-on sauces, can be scrubbed with a stiff bristle brush. You can also use an oven cleaner. Follow manufacturer's directions. Spray on the cleaner and let it soak overnight. Do not clean grill-rocks in a self-cleaning oven.
Element		<ul style="list-style-type: none"> • No cleaning is needed. Spatters or spills will burn off. Do not put in water.
Drain jars (under cooktop basin(s))	Warm, soapy water and a sponge or nonabrasive plastic scrubbing pad OR Dishwasher	<ul style="list-style-type: none"> • Empty the jar from time to time to prevent spillovers. • Unscrew and remove the jar to empty it. If the jar is broken replace it with any heat-tempered jar, such as a canning jar. The jar should have a standard screw neck.
Cover	Warm, soapy water and a sponge	<ul style="list-style-type: none"> • Wash, rinse, and dry well. • Do not clean in a dishwasher.
Area under grill	Warm, soapy water and a sponge or nonabrasive plastic scrubbing pad OR Paper towels and household cleanser	<ul style="list-style-type: none"> • Wash, wipe with clean water, and dry well. • Use nonabrasive, plastic scrubbing pad on heavily soiled areas. • For heavy soil, soak paper towels in household cleanser and lay them on the soil for at least ½ hour or longer. • To remove stubborn soil, spray with an oven cleaner, let it soak overnight, wipe with clean water, and dry well.

Griddle

Installing

You can install a griddle accessory on the left basin of your cooktop (and in the right basin of model RC8700ED). To use this accessory you must have grill accessory Part Number RCM20DB. To get the griddle accessory, order Part Number RCM40DB from a Whirlpool service company or dealer (see Step 2 on page 38) or call the Whirlpool Consumer Assistance Center toll-free 1-800-253-1301.

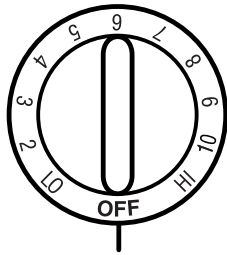

1. **Make sure** the grill element and grill-rocks are installed and the control knobs are turned off.

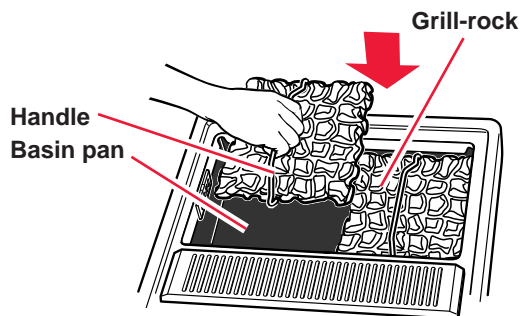

2. **If grill element is not installed**, place the two grill-rocks into an empty basin pan. The grill-rock handles must run parallel to the front of the cooktop. You have to use the grill-rocks because they hold up the grill element.

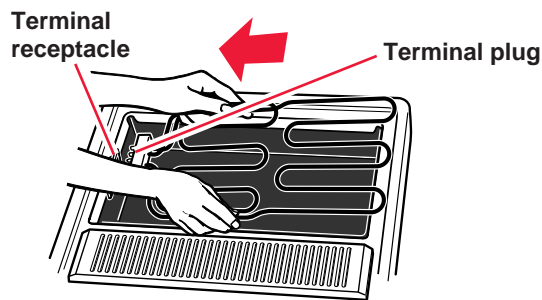

Position the grill element with the terminal plug towards the terminal receptacle. **Slide** the element towards the receptacle until the terminal plug is all the way inside it. The grill element should rest on the handles of the grill-rocks.

NOTE: Do not use the grill grates.

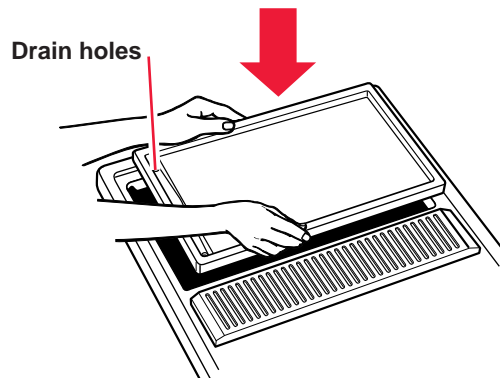

3. **Place** the griddle over the grill element so that the drain holes are in front. This will let extra grease collect in the drain jar.

NOTE: The bottom of the griddle should make contact with the top of the grill element.

Using

Before using the griddle for the first time:

1. **Wash** griddle in warm, soapy water. Rinse and dry well.
2. **Preheat** griddle for five minutes at the settings shown in the “Griddle chart” on page 32.
3. **After preheating, lightly wipe** the top of the griddle with cooking oil. This prevents sticking. You don't have to grease the griddle every time you use it. Do not use shortening or butter to grease the griddle.

NOTE: If the griddle is seasoned prior to preheating, the oil forms a varnish-like finish on the griddle. This finish is difficult to remove.

Griddling tips

- **Place** food right on the cooking surface of the griddle.
- **Turn off** the griddle element when cooking is finished. Leaving the element on will damage the griddle.
- **Do not use** cookware on the griddle. Use only plastic or nylon kitchen utensils on the griddle. Metal could damage the nonstick cooking surface.

! WARNING



Fire Hazard

Be sure the griddle controls are off and the griddle is cool and covered when not in use.

Failure to do so can result in fire or burns.

Griddle chart

Preheat for five to ten minutes at the settings listed below. **Do not preheat on HI.** Griddling times are guidelines only and may need to be adjusted to get the taste and/or

doneness you want. Also, low voltage and elements not close enough to the griddle may affect the cooking times and control settings.

FOOD	CONTROL SETTING	APPROXIMATE COOKING TIME (in minutes)	
		FIRST SIDE	SECOND SIDE
Sausage patties	9-10	4-5	2-4
Bacon (slice)	10	3-5	2
Ham slice	9	4	2
Hamburgers	9	6	5
Fish sticks (frozen)	8	5-7	5-6
Hot dogs	10	5-6	4-5
Buns	9	3	
French toast	10	2-3	2-3
Grilled cheese sandwiches	9	4	3
Pancakes	10	2	1-2
Eggs	8	2-3	1 or less

Caring for griddle

NOTE: Let cooktop cool before cleaning.

You must clean your griddle after each use to keep the finish in good shape.

PART	WHAT TO USE	HOW TO CLEAN
Griddle	Warm, soapy water and a nonabrasive plastic scrubbing pad	<ul style="list-style-type: none"> • Wash once griddle has cooled. Do not put a hot griddle in cold water. • For heavy soil, use a nonabrasive scrubbing pad. <p>NOTE: Do not wash in a dishwasher. Strong detergents can remove some of the nonstick finish.</p>
Grill-rocks	Warm, soapy water and a nonabrasive plastic scrubbing pad OR Dishwasher	<ul style="list-style-type: none"> • Wash, rinse, and dry well. Clean often or after any large build-up of grease. You can wash grill-rocks in a dishwasher instead if you have first removed burned-on soil.
Element		<ul style="list-style-type: none"> • No cleaning is needed. Spatters or spills will burn off. Do not put in water.
Area under grill-rocks	Warm, soapy water and a sponge or nonabrasive plastic scrubbing pad OR Paper towels and household cleanser	<ul style="list-style-type: none"> • Wash, wipe with clean water, and dry well. • Use nonabrasive, plastic scrubbing pad on heavily soiled areas. • For heavy soil, soak paper towels in household cleanser and lay them on the soil for at least ½ hour or longer.

Vent

Using

The built-in vent system removes cooking vapors, odors, and smoke from foods prepared on the cooktop, grill, and griddle. The vent system will go on by itself when the grill element or griddle is being used.

To turn on the vent system yourself:

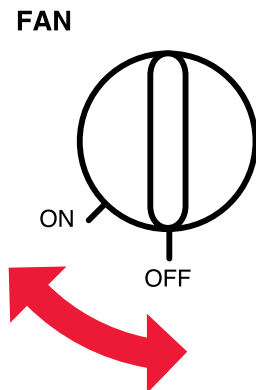

- **Turn** the vent fan knob to ON.
- **You can manually** control the vent fan only when using the coil or ceramic surface units. You cannot manually control the vent fan while you are using the grill or griddle.
- **If the vent fan** turns on automatically, it will turn off automatically when you turn off the grill or griddle. If you turn the vent fan on manually, you will need to shut it off manually.

⚠ WARNING



Cut Hazard

Do not put hands into vent when fan or controls are on.

Doing so can result in serious cuts.

Caring for vent

⚠ WARNING



Electrical Shock Hazard

Disconnect the electrical supply before servicing the cooktop.

Turn fan and cooktop controls off before cleaning the vent system.

Do not put hand into vent when fan or controls are on.

Failure to follow these instructions can result in death, electrical shock, serious injury, or cuts.

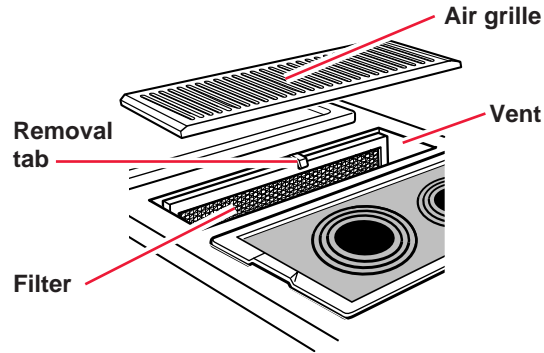

NOTE: The vent fan system turns on by itself when the grill or griddle is used.

To keep your vent system working well, clean it regularly using the chart below.

PART	WHAT TO USE	HOW TO CLEAN
Air grille	Warm, soapy water and a sponge OR Dishwasher	<ul style="list-style-type: none"> Wash, rinse, and dry well.
Filter	Warm, soapy water and a sponge OR Dishwasher	<ul style="list-style-type: none"> Clean in sink or dishwasher when soiled. <p>NOTE: Do not run the ventilation system without the filter. Filter should always be placed at an angle. As you face the front of the cooktop, the top of the filter should rest against the left side of the vent opening and the bottom of the filter should rest against the right side of the ventilation chamber, at the bottom. If the filter is flat against the fan wall, the ventilation system will not work well.</p>
Vent	Warm, soapy water and a sponge OR Spray household cleaner and a paper towel	<ul style="list-style-type: none"> Clean whenever the chamber becomes soiled.

Troubleshooting

Most cooking problems often are caused by little things you can find and fix without tools of any kind. Check the lists below and on the next page before calling for assistance or service. If you still need help, see “Requesting Assistance or Service” on page 38.

If nothing operates, check the following:

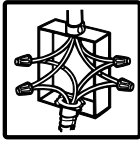

Is the cooktop wired into a live circuit with the proper voltage?
(See Installation Instructions.)



Have you blown a household fuse or tripped a circuit breaker?



Other possible problems and their causes:

PROBLEM	CAUSE
The surface units will not operate	<ul style="list-style-type: none"> You have blown a household fuse or tripped a circuit breaker. You have not plugged in coil elements all the way. You have not set the control knobs correctly. Push control knobs in before turning to a setting.
Grill does not work properly	<ul style="list-style-type: none"> You have not left space between food items. You have not preheated the grill for the proper amount of time. Food was partially frozen or very cold before grilling. This will make cooking time longer.
Control knob(s) will not turn	<ul style="list-style-type: none"> You are not pushing in before turning.
Venting results are not what you expected	<ul style="list-style-type: none"> Exhaust fan is not turned on. Vent filters are not clean or are not in place. Vent duct or outside opening is blocked. There is a draft in room where cooktop is installed. Meat is not well trimmed. Vent system has not been installed according to the Installation Instructions.
Cooking results are not what you expected	<ul style="list-style-type: none"> The cooktop is not level. (See Installation Instructions.)

PROBLEM	CAUSE
Cooking results are not what you expected (continued)	<ul style="list-style-type: none"><li data-bbox="443 253 1177 315">• The recipe you are using may need to be altered to improve the taste or appearance of the food.<li data-bbox="443 331 1177 421">• You are using a pan that is not the correct type or size. Refer to a reliable cookbook or recipe for recommended pan type and size.<li data-bbox="443 436 1177 528">• The cooking utensil is too large or too small for the surface unit being used. Pan should be the same size or slightly larger than the surface unit being used.

If none of these items was causing your problem, see “Requesting Assistance or Service” on page 38.

Requesting Assistance or Service

Before calling for assistance or service, please check "Troubleshooting" on pages 36-37. It may save you the cost of a service call. If you still need help, follow the instructions below.

1. If you need assistance* ...

Call the Whirlpool Consumer Assistance Center telephone number. Dial toll-free from anywhere in the U.S.A.:



1-800-253-1301

and talk with one of our trained consultants. The consultant can instruct you in how to obtain satisfactory operation from your appliance or, if service is necessary, recommend a qualified service company in your area.

If you prefer, write to:

Mr. William Clark
Consumer Assistance Representative
Whirlpool Corporation
2000 North M-63
Benton Harbor, MI 49022-2692

Please include a daytime phone number in your correspondence.

2. If you need service* ...

Whirlpool has a nationwide network of authorized Whirlpool service companies. Whirlpool service technicians are trained to fulfill the product warranty and provide after-warranty service, anywhere in the United States. To locate the authorized Whirlpool service company in your area, call our Consumer Assistance Center telephone number (see Step 1) or look in your telephone directory Yellow Pages under:



• **APPLIANCE-HOUSEHOLD-MAJOR, SERVICE & REPAIR**
- See: Whirlpool Appliances or Authorized Whirlpool Service
(Example: XYZ Service Co.)

• **WASHING MACHINES & DRYERS, SERVICE & REPAIR**
- See: Whirlpool Appliances or Authorized Whirlpool Service
(Example: XYZ Service Co.)

3. If you need FSP® replacement parts ...

FSP is a registered trademark of Whirlpool Corporation for quality parts. Look for this symbol of quality whenever you need a replacement part for your WHIRLPOOL® appliance. FSP replacement parts will fit right and work right, because they are made to the same exacting specifications used to build every new WHIRLPOOL appliance.

To locate FSP replacement parts in your area, refer to Step 2 or call the Whirlpool Consumer Assistance Center number in Step 1.

4. If you are not satisfied with how the problem was solved ...

- Contact the Major Appliance Consumer Action Program (MACAP). MACAP is a group of independent consumer experts that voices consumer views at the highest levels of the major appliance industry.
- Contact MACAP only when the dealer, authorized servicer, and Whirlpool have failed to resolve your problem.

Major Appliance Consumer Action Program
20 North Wacker Drive
Chicago, IL 60606
- MACAP will in turn inform us of your action.

* When asking for help or service:

Please provide a detailed description of the problem, your appliance's complete model and serial numbers, and the purchase date. (See page 2.) This information will help us respond properly to your request.

WHIRLPOOL CORPORATION MAJOR APPLIANCE WARRANTY

ONE YEAR LIMITED WARRANTY

For one year from the date of purchase, when this major appliance is operated and maintained according to instructions attached to or furnished with the product, Whirlpool Corporation or Whirlpool Canada LP (hereafter "Whirlpool") will pay for FSP® replacement parts and repair labor to correct defects in materials or workmanship. Service must be provided by a Whirlpool designated service company.

ITEMS WHIRLPOOL WILL NOT PAY FOR

1. Service calls to correct the installation of your major appliance, to instruct you how to use your major appliance, to replace or repair house fuses or to correct house wiring or plumbing.
 2. Service calls to repair or replace appliance light bulbs, air filters or water filters. Those consumable parts are excluded from warranty coverage.
 3. Repairs when your major appliance is used for other than normal, single-family household use.
 4. Damage resulting from accident, alteration, misuse, abuse, fire, flood, acts of God, improper installation, installation not in accordance with electrical or plumbing codes, or use of products not approved by Whirlpool.
 5. Any food loss due to refrigerator or freezer product failures.
 6. Replacement parts or repair labor costs for units operated outside the United States or Canada.
 7. Pickup and delivery. This major appliance is designed to be repaired in the home.
 8. Repairs to parts or systems resulting from unauthorized modifications made to the appliance.
 9. Expenses for travel and transportation for product service in remote locations.
 10. The removal and reinstallation of your appliance if it is installed in an inaccessible location or is not installed in accordance with published installation instructions.
-

DISCLAIMER OF IMPLIED WARRANTIES; LIMITATION OF REMEDIES

CUSTOMER'S SOLE AND EXCLUSIVE REMEDY UNDER THIS LIMITED WARRANTY SHALL BE PRODUCT REPAIR AS PROVIDED HEREIN. IMPLIED WARRANTIES, INCLUDING WARRANTIES OF MERCHANTABILITY OR FITNESS FOR A PARTICULAR PURPOSE, ARE LIMITED TO ONE YEAR OR THE SHORTEST PERIOD ALLOWED BY LAW. WHIRLPOOL SHALL NOT BE LIABLE FOR INCIDENTAL OR CONSEQUENTIAL DAMAGES. SOME STATES AND PROVINCES DO NOT ALLOW THE EXCLUSION OR LIMITATION OF INCIDENTAL OR CONSEQUENTIAL DAMAGES, OR LIMITATIONS ON THE DURATION OF IMPLIED WARRANTIES OF MERCHANTABILITY OR FITNESS, SO THESE EXCLUSIONS OR LIMITATIONS MAY NOT APPLY TO YOU. THIS WARRANTY GIVES YOU SPECIFIC LEGAL RIGHTS AND YOU MAY ALSO HAVE OTHER RIGHTS, WHICH VARY FROM STATE TO STATE OR PROVINCE TO PROVINCE.

Outside the 50 United States and Canada, this warranty does not apply. Contact your authorized Whirlpool dealer to determine if another warranty applies.

If you need service, first see the "Troubleshooting" section of the Use & Care Guide. After checking "Troubleshooting," additional help can be found by checking the "Assistance or Service" section or by calling Whirlpool. In the U.S.A., call **1-800-253-1301**. In Canada, call **1-800-807-6777**.

8/05

PART NO. 8111P467-60/9763400

© 2005 Whirlpool Corporation

® Registered Trademark/TM Trademark of Whirlpool, U.S.A.

10/2005

Printed in U.S.A.