

This Owner's Manual is provided and hosted by [Appliance Factory Parts](#).



BROAN E64E42SS Owner's Manual

[Shop genuine replacement parts for BROAN E64E42SS](#)



[Find Your BROAN HVAC Parts - Select From 1309 Models](#)

----- Manual continues below -----

E64E SERIES RANGE HOOD

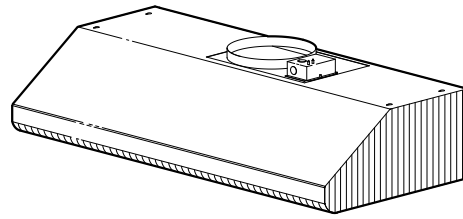

For domestic cooking only.

Styling is fresh and modern, yet designed to easily complement popular pro-style, high performance cooking products.

A complete installation requires several optional components. Refer to page 2 when planning your installation.

FEATURES

HOOD:

- Widths available - 30" to 48" in 6" increments
- Stainless steel, 22 gauge, type 430, #4 brush
- Stainless steel baffle filters with handles - easily accessible, dishwasher safe
- 2-level cooktop lighting (30" & 36" wide hoods = 2 lamps, 42" & 48" wide hoods = 3 lamps. Uses 50W, GU10 halogen lamps. Bulbs not included.)
- Solid-state, variable speed blower control with speed memory
- Exclusive, Heat Sentry™ turns blower ON to HIGH speed when excess heat is detected
- 10" round duct adapter (Model 332KR - included)

BACKSPLASH:

RMP Series (Optional)

- Widths - 30" to 48" in 6" increments
- Stainless steel, 22 gauge, type 430, #4 brush - protects back wall and wipes clean easily
- Two (2) dual position condiment storage shelves

SPECIFICATION:

- 120 VAC, 60 Hz,
- 0.8 Amps without blower (30" & 36" widths)
- 1.3 Amps without blower (42" & 48" widths)

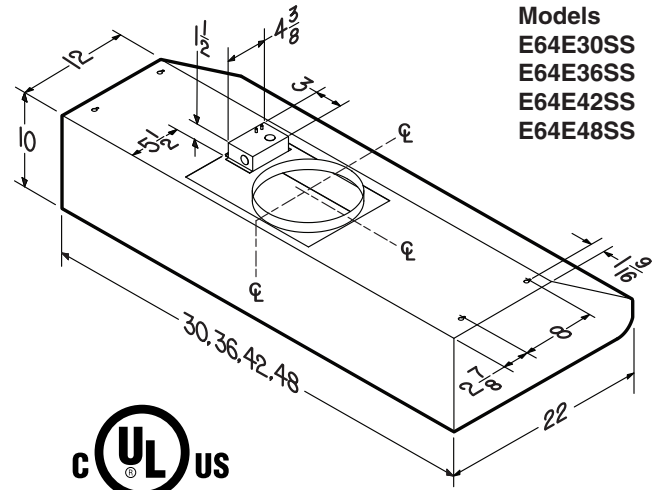

Models
E64E30SS
E64E36SS
E64E42SS
E64E48SS

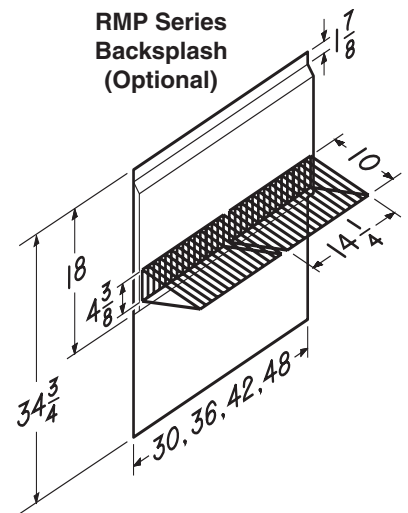

Broan-NuTone LLC Hartford, Wisconsin www.broan.com 800-558-1711
Broan-NuTone Canada Mississauga, Ontario www.broan.ca 877-896-1119

REFERENCE	QTY.	REMARKS	Project
			Location
			Architect
			Engineer
			Contractor
			Submitted By
			Date

E64E SERIES RANGE HOOD SYSTEM

INLINE AND EXTERIOR BLOWERS

