

This Owner's Manual is provided and hosted by [Appliance Factory Parts](#).



BROAN RP230SS Owner's Manual

[Shop genuine replacement parts for BROAN RP230SS](#)



[Find Your BROAN HVAC Parts - Select From 1309 Models](#)

----- Manual continues below -----

MODEL RP2 SERIES PRO-STYLE RANGE HOOD

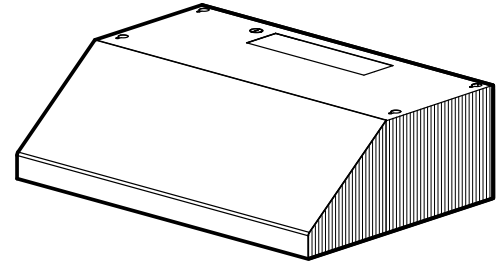

Designed to meet the performance needs of today's conventional cooking appliances.

FEATURES

- Two-speed blower control, convenient color-matched rocker
- Two-position light switch for "bright" or "night-light" illumination
- Dual halogen lamps with stainless steel trim rings (50W GU10 - MR16 lamps, purchase separately)
- High efficiency dual centrifugal blower with resilient anti-vibration motor mounts
- Broan Heat Sentry™ - automatically turns blower to high speed when excess cooking heat is detected
- Two washable, micromesh aluminum grease filters with Microban® coating that inhibits the formation of odor-producing bacteria and protects filter from discoloration
- Hemmed bottom for safety and good looks
- Damper/duct connector included
- Professional styling in Stainless Steel, Black and White
- Available in 30" and 36" widths
- Non-Ducted Recirculation Kit - NDK358 Series - Order to match color and size of hood
- Replacement filters (package of 2):
 - Grease with Microban - 97017456 (BPAPFA)
 - Grease without Microban - 97017455 (BPRPFA)
 - Non-Ducted - 97007662 (88F)

SPECIFICATIONS

VOLTS	AMPS	RPM	SONES		CFM		DUCT
			VER.	HOR.	VER.	HOR.	
120	7.0	1625	7.0	7.0	440	440	3¼" x10"



HVI-2100 CERTIFIED RATINGS comply with new testing technologies and procedures prescribed by the Home Ventilating Institute, for off-the-shelf products, as they are available to consumers. Product performance is rated at 0.1 in. static pressure, based on tests conducted in AMCA's state-of-the-art test laboratory. Sones are a measure of humanly-perceived loudness, based on laboratory measurements.

TYPICAL SPECIFICATION

Range hood shall be Broan RP2 Series.

Unit shall have a backdraft damper and be ducted vertically (horizontally) to the outside.

Unit shall have washable micromesh aluminum filters with special Microban® coating.

Unit shall have a permanently lubricated, dual centrifugal blower resiliently mounted and controlled with a two-speed control. RPM not to exceed 1625.

Hood shall have a two-speed rocker control and a separate, two-position light switch. Sides shall be straight and bottom hemmed - with no sharp edges. Stainless steel shall be 24-gauge, 430 series.

Air delivery shall be no less than 440 cfm and sound levels no greater than 7.0 Sones. All air and sound ratings shall be certified by HVI.

Unit shall be U.L. and cU.L. listed.

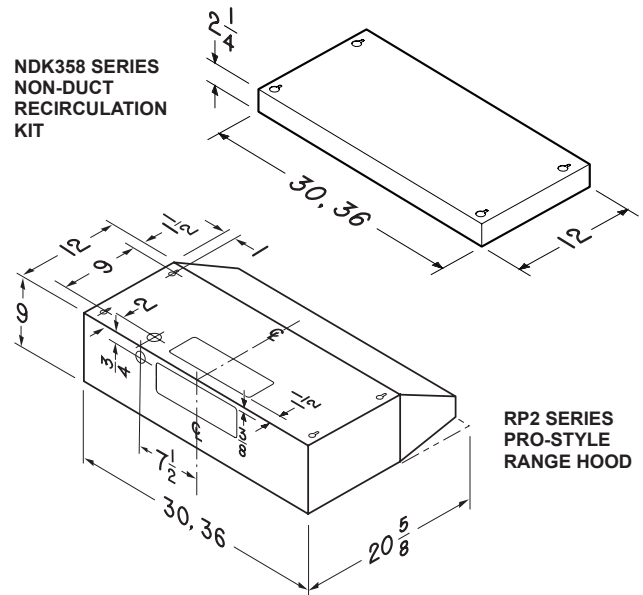

Broan-NuTone LLC, 926 West State Street, Hartford, WI 53027 (1-800-637-1453)

REFERENCE	QTY.	REMARKS	Project
			Location
			Architect
			Engineer
			Contractor
			Submitted by Date