

This Owner's Manual is provided and hosted by [Appliance Factory Parts](#).



BROAN RP136SS Owner's Manual

[Shop genuine replacement parts for BROAN RP136SS](#)



[Find Your BROAN HVAC Parts - Select From 1309 Models](#)

----- Manual continues below -----

PROFESSIONAL STYLE RANGE HOOD

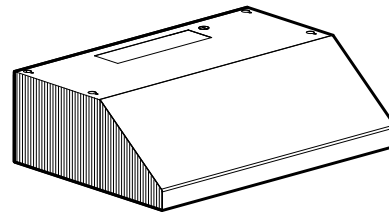

To register this product visit:
www.broan.com

READ AND SAVE THESE INSTRUCTIONS

 **FOR DOMESTIC COOKING ONLY** 

WARNING

TO REDUCE THE RISK OF FIRE, ELECTRIC SHOCK, OR INJURY TO PERSONS, OBSERVE THE FOLLOWING:

1. Use this unit only in the manner intended by the manufacturer. If you have questions, contact the manufacturer at the address or telephone number listed in the warranty.
2. Before servicing or cleaning unit, switch power off at service panel. Lock or tag service panel to prevent power from being switched on accidentally.
3. Installation work and electrical wiring (including switch location) must be done by a qualified person(s) in accordance with all applicable codes and standards, including fire-rated construction.
4. Provide sufficient air for proper combustion and exhausting of gases through the flue (chimney) of fuel burning equipment to prevent backdrafting. Follow the combustion equipment standards such as those published by the National Fire Protection Association (NFPA), the American Society for Heating, Refrigeration and Air Conditioning Engineers (ASHRAE), and local codes.
5. This product may have sharp edges. Be careful to avoid cuts and abrasions during installation and cleaning.
6. When cutting or drilling into wall or ceiling, do not damage electrical wiring and other hidden utilities.
7. Ducted fans must always be vented to the outdoors.
8. Use only metal ductwork.
9. As an alternative, this product may be installed with the UL-approved cord kit designated for the product, following instructions packed with the cord kit.
10. This unit must be grounded.

TO REDUCE THE RISK OF A RANGE TOP GREASE FIRE:

1. Never leave surface units unattended at high settings. Boilovers cause smoking and greasy spillovers that may ignite. Heat oils slowly on low or medium settings.
2. Always turn hood ON when cooking at high heat or when flambeing food (i.e. Crepes Suzette, Cherries Jubilee, Peppercorn Beef Flambe).
3. Clean ventilating fans frequently. Grease should not be allowed to accumulate on fan or filter.
4. Use proper pan size. Always use cookware appropriate for the size of the surface element.

WARNING

TO REDUCE THE RISK OF INJURY TO PERSONS IN THE EVENT OF A RANGE TOP GREASE FIRE, OBSERVE THE FOLLOWING:*

1. SMOTHER FLAMES with a close-fitting lid, cookie sheet, or metal tray, then turn off the burner. BE CAREFUL TO PREVENT BURNS. If the flames do not go out immediately, EVACUATE AND CALL THE FIRE DEPARTMENT.
2. NEVER PICK UP A FLAMING PAN — You may be burned or spread the fire.
3. DO NOT USE WATER, including wet dishcloths or towels - violent steam explosion will result.
4. Use an extinguisher ONLY if:
 - A. You know you have a Class ABC extinguisher and you already know how to operate it.
 - B. The fire is small and contained in the area where it started.
 - C. The fire department is being called.
 - D. You can fight the fire with your back to an exit.

* Based on "Kitchen Fire Safety Tips" published by NFPA.

CAUTION

1. For general ventilating use only. Do not use to exhaust hazardous or explosive materials and vapors.
2. For best capture of cooking impurities, range hood should be mounted so that the bottom of the hood is 18"-24" above the cooking surface.
3. Read specification label on product for information and requirements.

NOTE These instructions are for ducted installations only.

If hood is to be installed non-ducted:

Purchase a non-ducted filter kit from your local distributor or retailer. (Available for AP1 & RP2 Series hoods only.) Follow instructions included with the non-ducted kit.

Installer: Leave this manual with the homeowner.

Homeowner: Cleaning, Maintenance and Operating instructions on page 2.

CLEANING & MAINTENANCE

For performance, appearance, and health reasons, clean filter, fan and grease-laden surfaces. Use **only** a clean cloth and mild detergent solution on stainless and painted surfaces. Clean all-metal filters in the dishwasher.

The motor is permanently lubricated and never needs oiling. If the motor bearings make excessive or unusual noise, replace the motor with the exact service motor. The impeller should also be replaced.

Use 120 V, 50 W, shielded halogen bulbs - MR16 or PAR16 with GU10 base. Purchase bulbs separately.

The grease filters, bottom panel, and blower wheel should be cleaned frequently. Use a warm detergent solution. The grease filters and blower wheel are dishwasher safe.

Note: Some minerals, when in contact with dishwasher soap additives, may cause filters to discolor. This discoloration is not covered by the warranty.

OPERATION

Always turn the hood ON before cooking in order to establish an air flow in the kitchen. After turning off the range, let the hood run for a few minutes to clear the air.

HEAT SENTRY™

The hood is equipped with a Heat Sentry™ thermostat. This safety device will turn on or speed up the blower if it senses excess heat above the cooking surface.

If the blower is not on, or if it is running at low speed, the Heat Sentry™ will override the normal blower control and turn the blower on the high speed. When the temperature level drops to normal levels, the blower will return to its original setting.

RP SERIES HOOD

Operate the hood as follows:

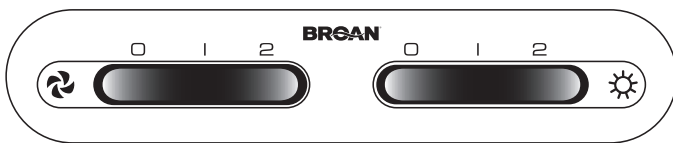

BLOWER SWITCH

This 3-position switch turns blower ON and OFF and controls blower speed.

Set switch to (1) position to turn blower ON to low speed.
Set switch to (2) position to turn blower ON to high speed.
Set switch to (0) position to turn blower OFF.

LIGHT SWITCH

This 3-position switch turns lights ON and OFF and controls their intensity.

Set switch to (1) position to turn lights ON to low intensity.
Set switch to (2) position to turn lights ON to high intensity.
Set switch to (0) position to turn lights OFF.

AP SERIES HOOD

Operate the hood as follows:

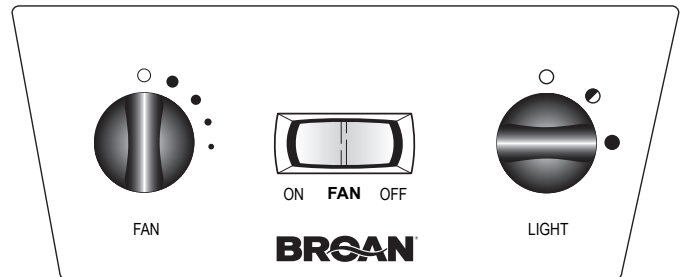

FAN

The 2-position switch (in center) turns blower ON and OFF. The 5-position switch (at left) controls blower speed.

- Blower is OFF (secondary blower OFF).
- Blower is ON at highest speed.
- As dots get smaller - blower speed decreases.

LIGHT

This 3-position switch (at right) turns lights ON and OFF and controls their intensity.

- Lights are OFF.
- Lights are ON to low intensity.
- Lights are ON to highest intensity.

PREPARE HOOD LOCATION

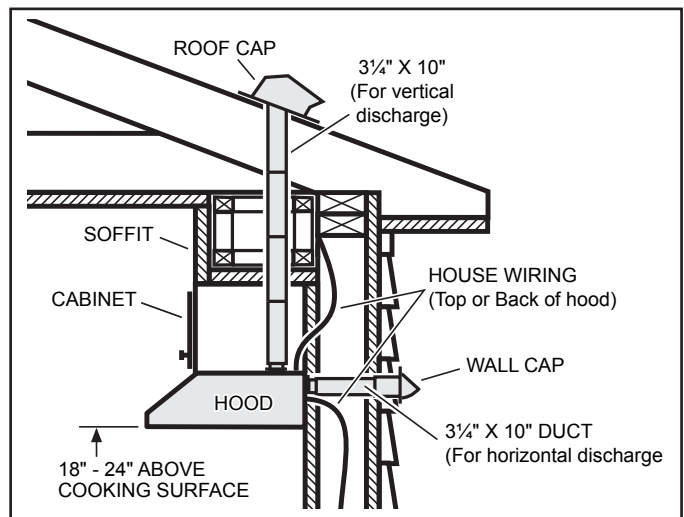

- 1 Determine whether hood will discharge vertically or horizontally. For vertical or horizontal discharge, run ductwork between the hood location and a roof cap or wall cap. For best results, use a minimum number of transitions and elbows.

- 2 Use the proper diagram below, for placement of ductwork and electrical cutout in cabinet or wall. For a non-ducted installation, DO NOT cut a duct access hole.

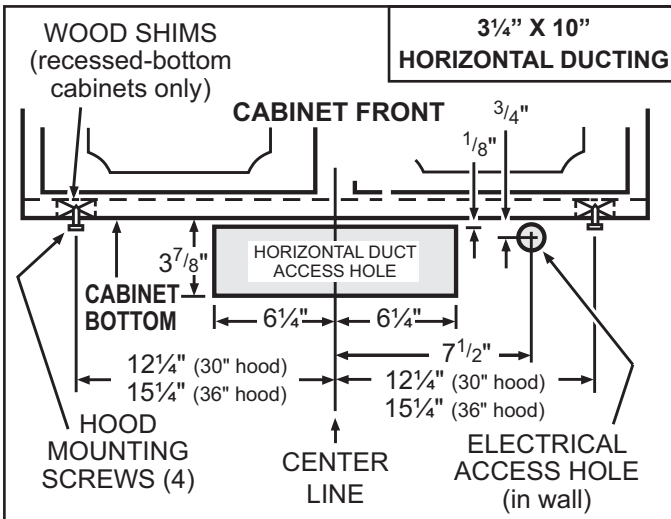
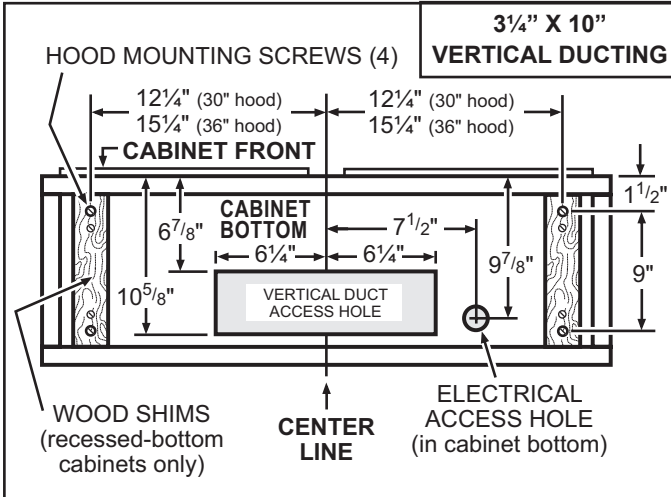

PREPARE THE HOOD

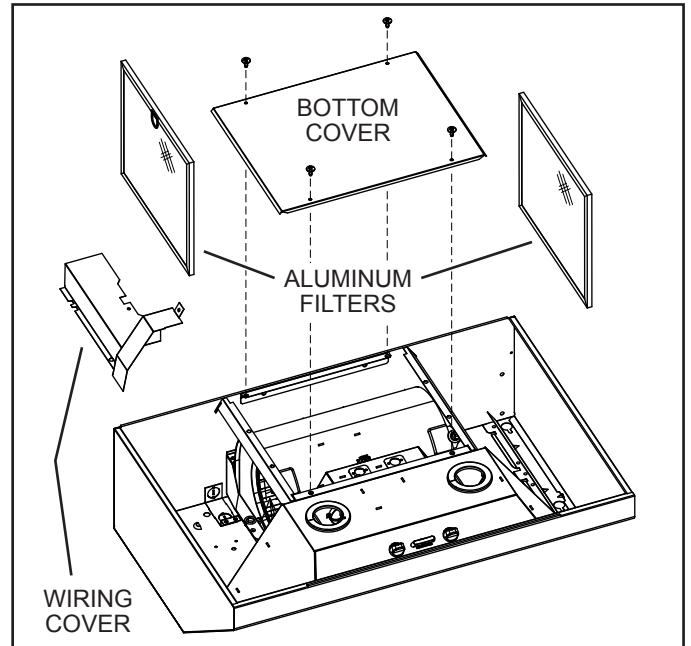

- 3 Remove the **Aluminum Filters**, **Bottom Cover**, and **Wiring Cover** from the hood.

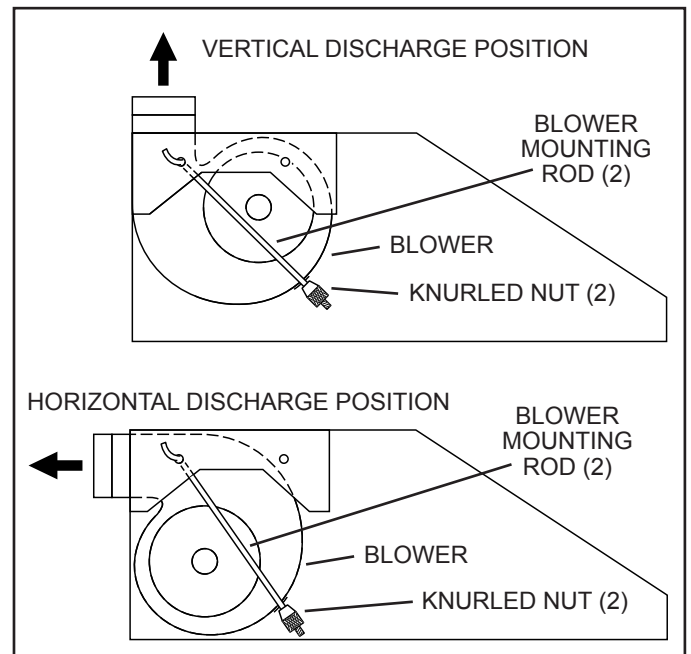

- 4 **Blower** is shipped in **Vertical Discharge Position**.

To change blower to **Horizontal Discharge Position**:

Remove **Knurled Nuts** from **Blower Mounting Rods**. Disengage mounting rods from blower and rotate blower to horizontal discharge position. Re-engage mounting rods and tighten blower in place with knurled nuts.

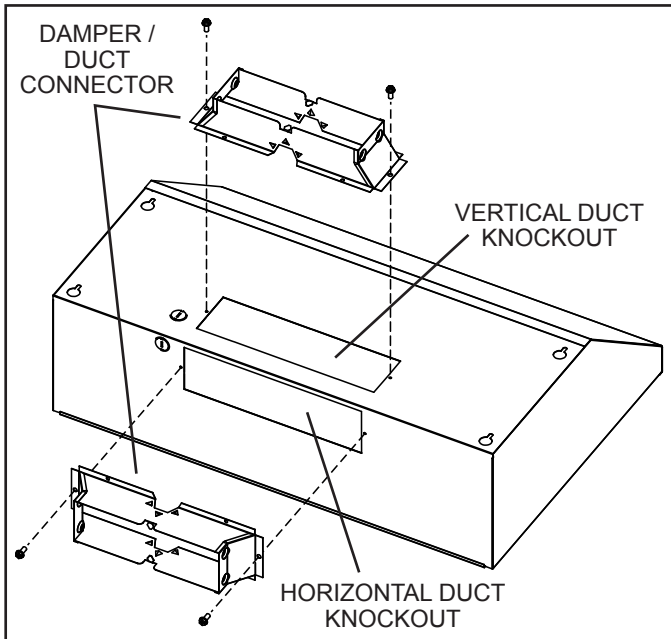

- 5 Remove **Vertical Duct Knockout** or **Horizontal Duct Knockout** and attach **Damper / Duct Connector** with two (2) screws (supplied).

INSTALL THE HOOD



WARNING

To reduce the risk of electrical shock, switch power off at service panel. Lock or tag service panel to prevent power from being switched on accidentally.

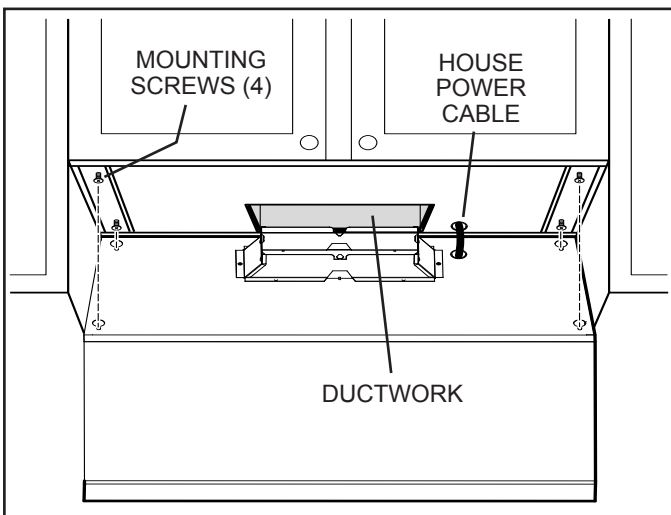

- 6 Run **House Power Cable** between service panel and hood location. Attach power cable to hood using appropriate connector.
- 7 Hold the hood in position under the cabinet. Make sure the damper / duct connector enters the **Ductwork** and that the damper opens and closes freely.
- 8 Tighten the four (4) **Mounting Screws** completely to secure the hood to the cabinet.

CONNECT THE WIRING

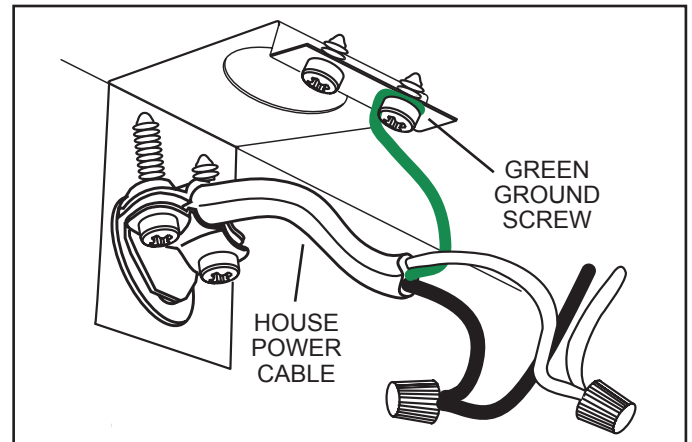

- 9 Connect **House Power Cable** to range hood wiring - BLACK to BLACK, WHITE to WHITE, and GREEN or BARE WIRE to **GREEN Ground Screw**.

COMPLETE INSTALLATION

- 10 Re-install the wiring cover, bottom cover, and filters that were removed in Step 3.

INSTALL LIGHT BULBS

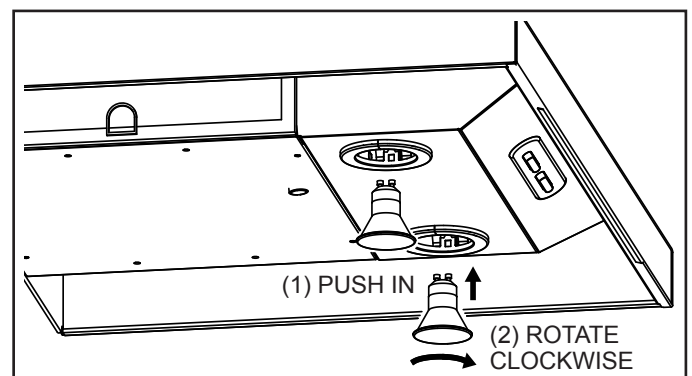

- 11 Install **Halogen Bulbs**. Use 120 V, 50 W, shielded halogen bulbs - MR16 or PAR16 with GU10 base. Purchase bulbs separately.

SERVICE PARTS

KEY NO.	PART NO.	DESCRIPTION
1	97017222	Feature Panel Weldment - RP-Black
	97017223	Feature Panel Weldment - RP-White
	97017224	Feature Panel Weldment - RP-Silver
2	97017324	Feature Panel Weldment - AP-Black
	97017325	Feature Panel Weldment - AP-White
	97017326	Feature Panel Weldment - AP-Silver
3	97009517	Bottom Cover - Black
	97007895	Bottom Cover - White
	97007631	Bottom Cover - Silver
4	97017429	Damper Assembly
5	97007656	Wire Cover Assembly
6	97017428	Thermostat Bracket Assembly
7	98006546	Light Socket Cover
8	99400084	Bushing Split Heyco #2873
9	99271346	Socket/Trim Ring Assembly
10	97017312	Control - RP, Black
	97017264	Control - RP, White
11	99111379	Spacer .50 x .375 Nylon
12	97017455	Filter, Aluminum (Qty. 2)
	97017456	Filter, Aluminum with Microban (Qty. 2)
13	99420464	Blower Mounting Rod
14	99150617	8-18 x .375 Truss Head Sheet Metal Screw *
15	99170245	8-18x.375 Hex Head Phillips Sheet Metal Screw *
16	99260476	Blower Mounting Rod Nut
17	97007313	Blower Scroll Housing
18	99100491	Motor Isolation Bushing
19	98005212	Motor Retaining Ring
20	99080597	Motor
21	99020142	Blower Wheel, Clockwise
22	99020143	Blower Wheel, Counterclockwise
23	99400055	Heyco Snap Bushing
24	99500323	PVC Foam
25	98010342	Ring, Inlet
26	99260491	Hex Nut 3/8-32
27	99260470	Hex Nut 15/32-32
28	600348	Knob - Black
	600349	Knob - White
29	97016970	Switch - Black
	97016971	Switch - White
30	99260485	Nut Sheet Metal U-Type
**	99400052	Bushing Strain Relief (Not Shown)
**	99770113	Wire Harness - NSP, RP
**	99770115	Wire Harness - AP
**	99030132	Rotary Fan Control
**	97016439	Rotary Light Control

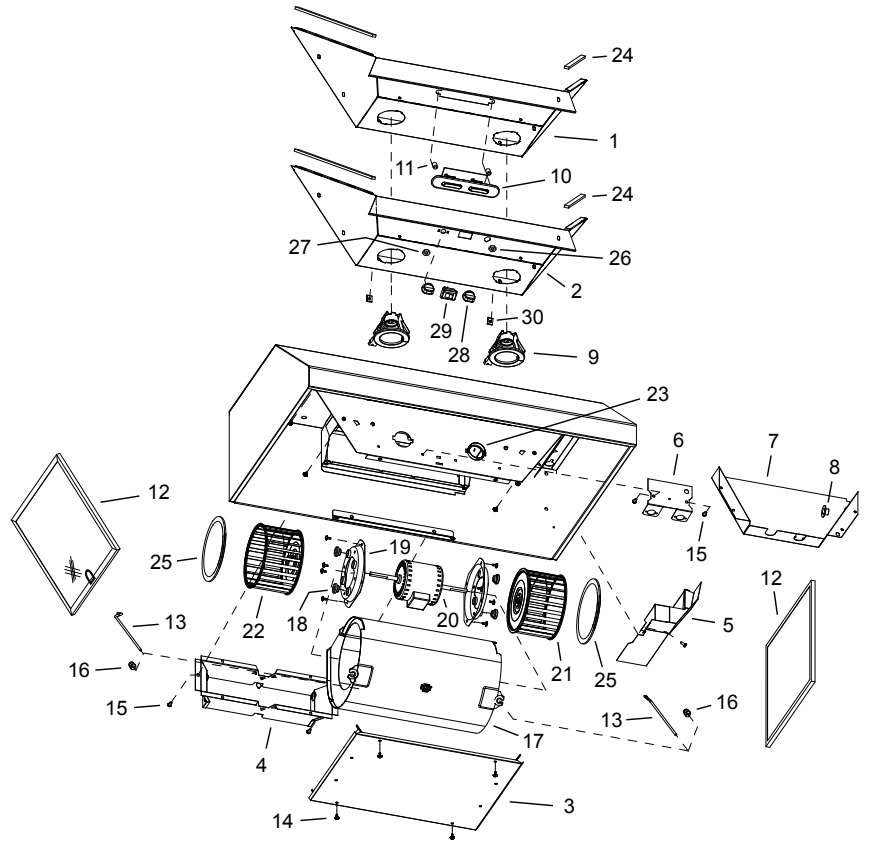

WARRANTY

BROAN ONE YEAR LIMITED WARRANTY

Broan warrants to the original consumer purchaser of its products that such products will be free from defects in materials or workmanship for a period of one year from the date of original purchase. THERE ARE NO OTHER WARRANTIES, EXPRESS OR IMPLIED, INCLUDING, BUT NOT LIMITED TO, IMPLIED WARRANTIES OF MERCHANTABILITY OR FITNESS FOR A PARTICULAR PURPOSE.

During this one-year period, Broan will, at its option, repair or replace, without charge, any product or part which is found to be defective under normal use and service. THIS WARRANTY DOES NOT EXTEND TO FLUORESCENT LAMP STARTERS AND TUBES. This warranty does not cover (a) normal maintenance and service or (b) any products or parts which have been subject to misuse, negligence, accident, improper maintenance or repair (other than by Broan), faulty installation or installation contrary to recommended installation instructions.

The duration of an implied warranty is limited to the one-year period as specified for the express warranty. Some states do not allow limitation on how long an implied warranty lasts, so the above limitation may not apply to you.

BROAN'S OBLIGATION TO REPAIR OR REPLACE, AT BROAN'S OPTION, SHALL BE THE PURCHASER'S SOLE AND EXCLUSIVE REMEDY UNDER THIS WARRANTY. BROAN SHALL NOT BE LIABLE FOR INCIDENTAL, CONSEQUENTIAL OR SPECIAL DAMAGES ARISING OUT OF OR IN CONNECTION WITH PRODUCT USE OR PERFORMANCE. Some states do not allow the exclusion or limitation of incidental or consequential damages, so the above limitation may not apply to you.

This warranty gives you specific legal rights, and you may also have other rights, which vary from state to state. This warranty supersedes all prior warranties.

To qualify for warranty service, you must (a) notify Broan at the address or telephone number below, (b) give the model number and part identification and (c) describe the nature of any defect in the product or part. At the time of requesting warranty service, you must present evidence of the original purchase date.

In the United States, contact: **Broan-NuTone LLC**, 926 West State Street, Hartford, WI 53027 (1-800-637-1453)

In Canada, contact: **Broan-NuTone Canada, Inc.**, 1140 Tristar Drive, Mississauga, Ontario L5t 1H9 (1-888-882-7626)

* Standard hardware - may be purchased locally.

** Not illustrated

Order replacement parts by PART NO. - not by KEY NO.

Replacement parts can now be ordered on our website.

Please visit us at www.broan.com.