

This Owner's Manual is provided and hosted by [Appliance Factory Parts](#).



BROAN 883823 Owner's Manual

[Shop genuine replacement parts for BROAN 883823](#)



[Find Your BROAN HVAC Parts - Select From 1309 Models](#)

----- Manual continues below -----

MODEL 88000 CONVERTIBLE MICROTEK® SYSTEM IV RANGE HOOD

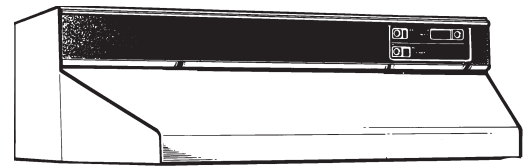

A top-of-the-line hood with a multi-layer duct-free filter system unequalled in the industry.

FEATURES

- Infinite speed slide control with solid state blower memory
- Two-position light switch for "bright" or "night-light" illumination
- Bright polymeric light lens (accepts 2 - 75W bulbs)
- High efficiency dual centrifugal blower with resilient anti-vibration motor mounts
- Broan Heat Sentry™ - automatically turns blower to high speed when excess cooking heat is detected
- Two washable aluminum filters
- Twin Microtek® System IV filters for optimum capture of cooking contaminants in the duct-free mode (purchase separately)
- Mitered sides and hemmed bottom for safety and good looks
- Contemporary styling in White, Almond, Black, White-on-White, Stainless Steel and Biscuit
- Available in 30", 36" and 42" widths
- **Special Order Sizes** - 33" and 39" (White, Almond and Stainless Steel and Biscuit only)
- **Special Order Size** - 48" (All colors)

SPECIFICATIONS

VOLTS	AMPS	RPM	SONES		CFM		DUCTFREE RHPINDEX*	DUCT
			VER.	HOR.	VER.	HOR.		
120	4.5	1550	5.5	6.0	360	350	59.09	3-1/4" x 10"

HVI certified ratings comply with testing procedures prescribed by the Home Ventilating Institute. Ratings are at 0.1 in. static pressure. Sones are a measure of loudness and are measured in HVI's semi-reverberant sound test room.

*RHP INDEX (Range Hood Performance) is a scientific measure of the effectiveness of a range hood in removing grease, smoke, dirt and other solid pollutants from the air. The RHP Index compares the performance of each hood to others.

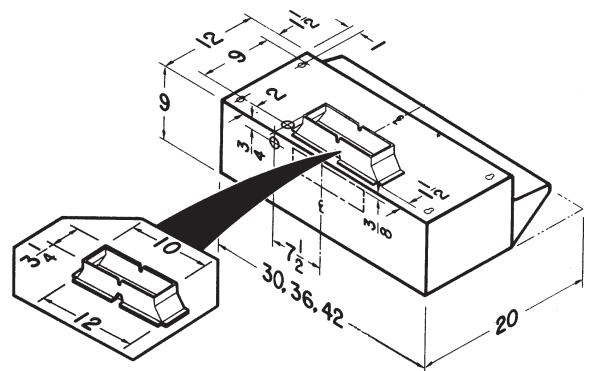

TYPICAL SPECIFICATION

Range hood shall be Broan Model 88000.

Unit shall be convertible between ducted (using washable aluminum filters) and duct-free (using Microtek® System IV filters).

Unit shall have a permanently lubricated, dual centrifugal blower, resiliently mounted and controlled with an infinite speed, solid state control. RPM not to exceed 1550. Hood shall have a separate, two-position light switch.

Sides shall be mitered and bottom hemmed - with no sharp edges.

Air delivery shall be no less than 360 CFM and sound levels no greater than 5.5 Sones (vertical discharge), 350 CFM and 6.0 Sones (horizontal discharge). All air and sound ratings shall be certified by HVI.

Unit shall be U.L. listed.

Broan-NuTone LLC, 926 West State Street, Hartford, WI 53027 (1-800-637-1453)

REFERENCE	QTY.	REMARKS	Project
			Location
			Architect
			Engineer
			Contractor
			Submitted by Date