

This Owner's Manual is provided and hosted by [Appliance Factory Parts](#).



BROAN 893001 Owner's Manual

[Shop genuine replacement parts for BROAN 893001](#)



[Find Your BROAN HVAC Parts - Select From 1309 Models](#)

----- Manual continues below -----

BROAN

89000 Series

Deluxe Ducted Range Hood Installation Instructions

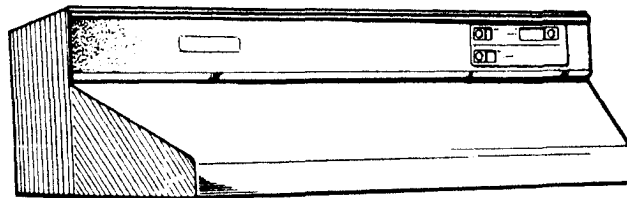

READ AND SAVE THESE INSTRUCTIONS

The 89000 Series hood is designed for use over convertible cooktops with drop-in griddle, rotisserie, or grille accessories. It may be wired and ducted either horizontally or vertically.

NOTE

Not for installation in island applications. Not for use over charcoal grilles, gas grilles over 14,000 BTU, or electric grilles over 4,000 watts.

NOTE

This hood is designed for use in high heat applications and cannot be used in the ductfree version. Do not convert this hood to ductfree operation. Vent hood to the outside only.

⚠ INTENDED FOR DOMESTIC COOKING ONLY. ⚠

WARNING ⚡ 🔥

TO REDUCE THE RISK OF FIRE, ELECTRIC SHOCK, OR INJURY TO PERSONS, OBSERVE THE FOLLOWING:

1. Use this unit only in the manner intended by the manufacturer. If you have questions, contact the manufacturer at the address or telephone number listed in the warranty.
2. Before servicing or cleaning unit, switch power off at service panel and lock the service disconnecting means to prevent power from being switched on accidentally. When the service disconnecting means cannot be locked, securely fasten a prominent warning device, such as a tag, to the service panel.
3. Installation work and electrical wiring must be done by a qualified person(s) in accordance with all applicable codes and standards, including fire-rated construction codes and standards.
4. Sufficient air is needed for proper combustion and exhausting of gases through the flue (chimney) of fuel burning equipment to prevent backdrafting. Follow the heating equipment manufacturer's guideline and safety standards such as those published by the National Fire Protection Association (NFPA), and the American Society for Heating, Refrigeration and Air Conditioning Engineers (ASHRAE), and the local code authorities.
5. When cutting or drilling into wall or ceiling, do not damage electrical wiring and other hidden utilities.
6. Ducted fans must always be vented to the outdoors.
7. Do not use this range hood with an additional speed control device.
8. To reduce the risk of fire, use only metal ductwork.
9. Use with approved cord-connection kit only.
10. This unit must be grounded.

TO REDUCE THE RISK OF A RANGE TOP GREASE FIRE:

1. Never leave surface units unattended at high settings. Boilovers cause smoking and greasy spillovers that may ignite. Heat oils slowly on low or medium settings.
2. Always turn hood ON when cooking at high heat or when cooking flaming foods.
3. Clean ventilating fans frequently. Grease should not be allowed to accumulate on fan or filter.
4. Use proper pan size. Always use cookware appropriate for the size of the surface element.

WARNING ⚡ 🔥

TO REDUCE THE RISK OF INJURY TO PERSONS IN THE EVENT OF A RANGE TOP GREASE FIRE, OBSERVE THE FOLLOWING:

1. SMOTHER FLAMES with a close-fitting lid, cookie sheet, or metal tray, turn off the burner. BE CAREFUL TO PREVENT BURNS. If the flames do not go out immediately, EVACUATE AND CALL THE FIRE DEPARTMENT.
2. NEVER PICK UP A FLAMING PAN - You may be burned.
3. DO NOT USE WATER, including wet dishcloths or towels - a violent stream explosion will result.
4. Use an extinguisher ONLY if:
 - A. You know you have a Class ABC extinguisher and you already know how to operate it.
 - B. The fire is small and contained in the area where it started.
 - C. The fire department is being called.
 - D. You can fight the fire with your back to an exit.

*Based on "Kitchen Firesafety Tips" published by NFPA.

CAUTION ⚠

1. For general ventilating use only. Do not use to exhaust hazardous or explosive materials and vapors.
2. To avoid motor bearing damage and noisy/and or unbalanced impellers, keep drywall spray, construction dust, etc. off power unit.
3. For best capture of cooking impurities, your range hood should be mounted 18-24" above the cooking surface.
4. Please read specification label on product for further information and requirements.

TOOLS AND MATERIALS REQUIRED

TOOLS

- Drill, electric or ratchet drive
- 1-1/4" Spade bit
- Common head and phillips head screwdriver
- Pliers
- Tape measure or ruler and pencil.
- Saber saw or drywall saw
- Metal snips

MATERIALS

- Electrical wiring and supplies of type to comply with local codes
- Roof or wall cap
- Roof cement or caulk
- Duct and duct tape

For Installation on Kitchen Cabinets with Recessed Bottoms Only:

- Two 1" x 2" x 12" (approximate length) wood strips (purchase locally)
- Four 1-1/4" long flat head wood screws (purchase locally) to fasten strips to cabinet bottom

**INSTALLER: Leave This Manual With The Homeowner.
HOMEOWNER: Use and Care Information on Page 7.**

PLAN DUCTWORK INSTALLATION

Begin planning ductwork by deciding where duct will run between hood and outside. For best performance, use shortest possible duct run and a minimum number of elbows. In more complex situations, 3-1/4" x 10" duct can be converted to round duct by means of a transition. FIGS. 1A - E below show several choices.

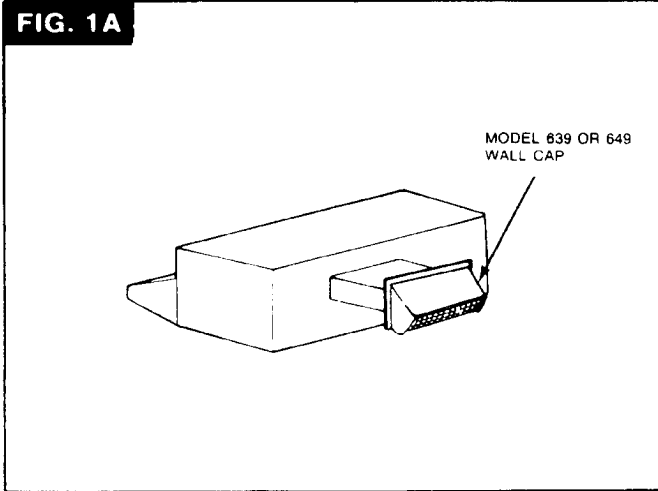

FIG. 1A. Ducting directly through outside wall. If wall cap is used directly off back of hood, check to make sure that damper flap in damper/duct connector on hood does not interfere with damper flap in wall cap. If it does, remove flap on hood damper/duct connector.

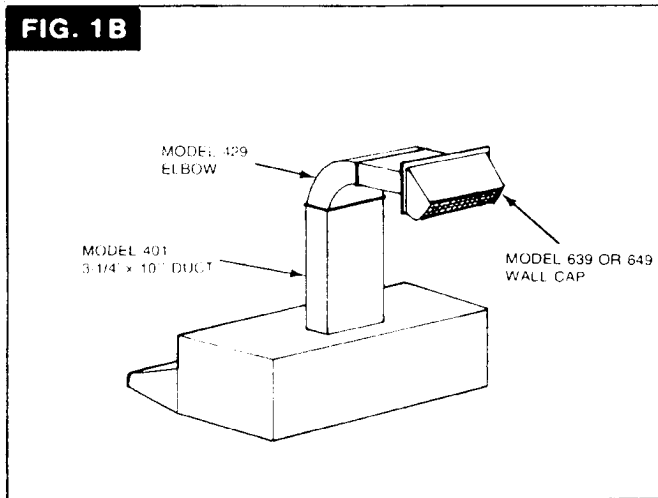

FIG. 1B. At times it will be easier to run duct vertically and use an elbow.

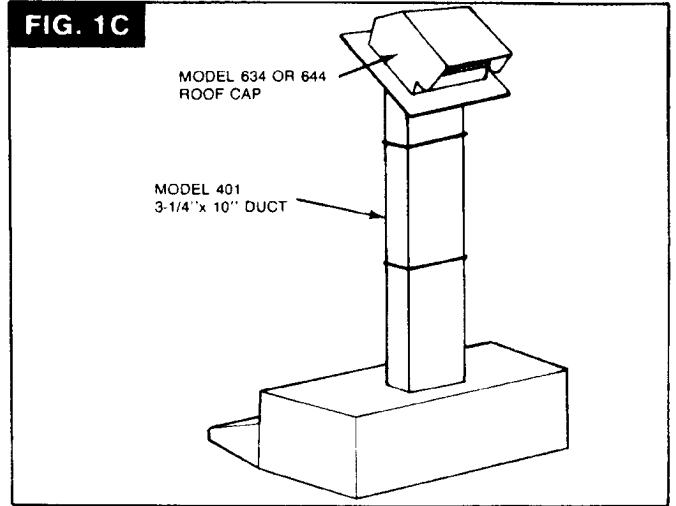

FIG. 1C. Ducting straight up through roof using 3-1/4" x 10" duct. For single story installations.

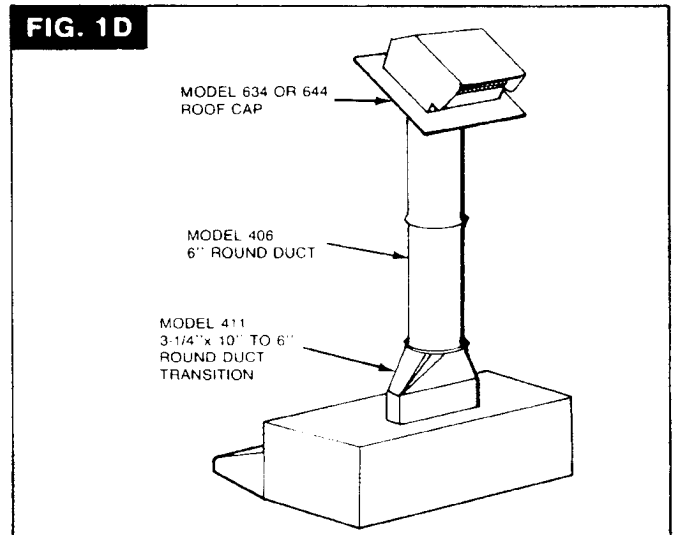

FIG. 1D. Straight up through roof using round duct.

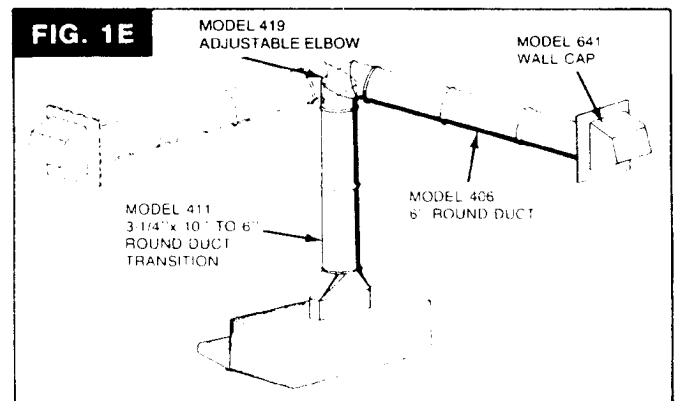
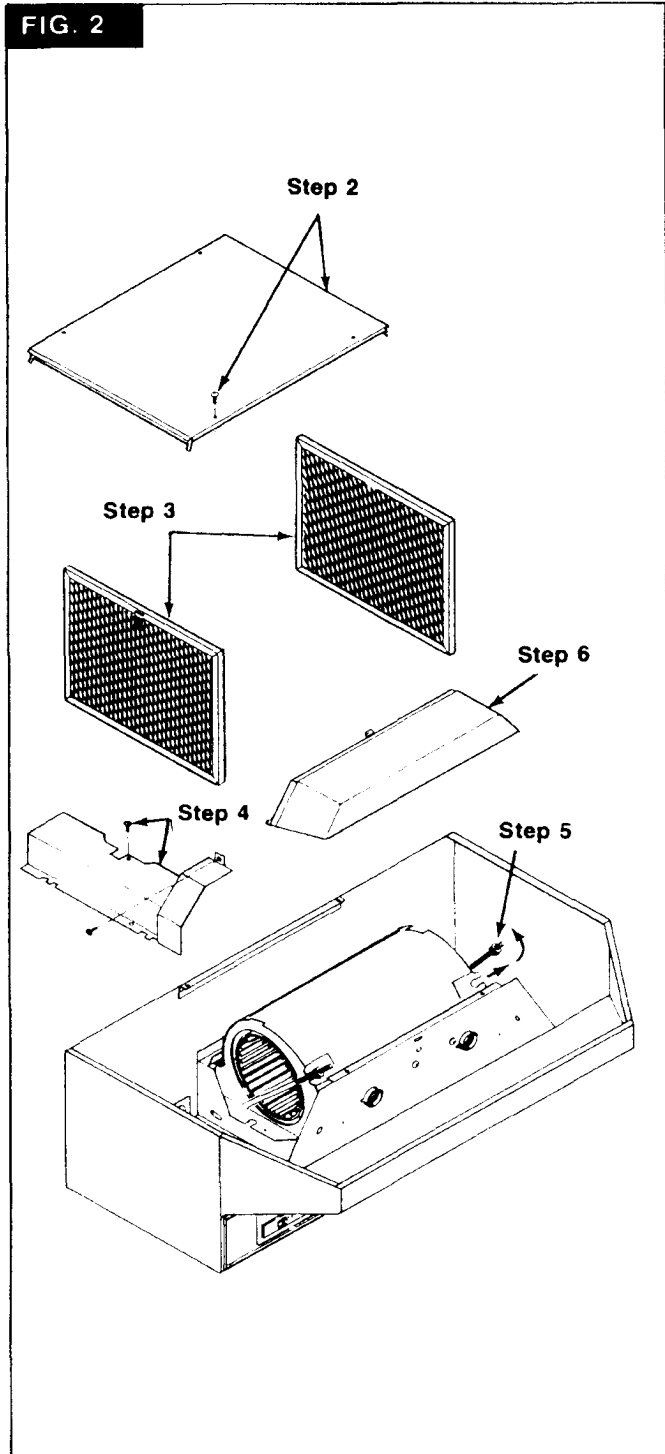

FIG. 1E. Ducting between ceiling joists for multi-story installations or through soffits above cabinets where soffit connects to outside walls.

PREPARE HOOD



1. Unpack hood and check contents. You should receive:
 - 1 - assembled hood
 - 1 - plastic bag, containing:
 - 4 - 7/8" wood screws for mounting hood to cabinet
 - 2 - 1/4" black sheet metal screws for mounting damper/duct connector to hood
 - 2 - aluminum filters
 - 1 - damper/duct connector

For Steps 2 - 6 below, refer to FIG. 2.

2. Set hood upside down and remove bottom cover and screws.
3. Remove filters.
4. Remove wiring box cover and screws.
5. To make hood lighter and easier to handle, remove blower assembly.
 - a.) Unplug blower.
 - b.) Loosen knurled nuts on mounting rods and slip rods out of blower mounting brackets. Do not remove nuts completely from rods.
 - c.) Lift out blower and set blower aside.

CAUTION

Do not grasp blower by blower wheels. Wheels may be damaged.

6. Remove light lens. Squeeze sides of lens toward center of hood and lift lens out.
7. Remove either top or rear electrical knockout. (FIG. 3)
8. Remove either top or rear duct knockout. (FIG. 3)
9. Fasten damper/duct connector to hood over opening. Use two black sheet metal screws provided in parts bag. (FIG. 3)

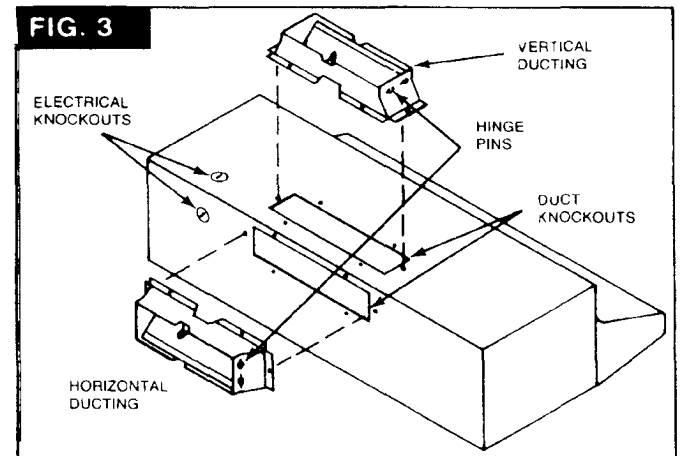

PREPARE THE INSTALLATION LOCATION

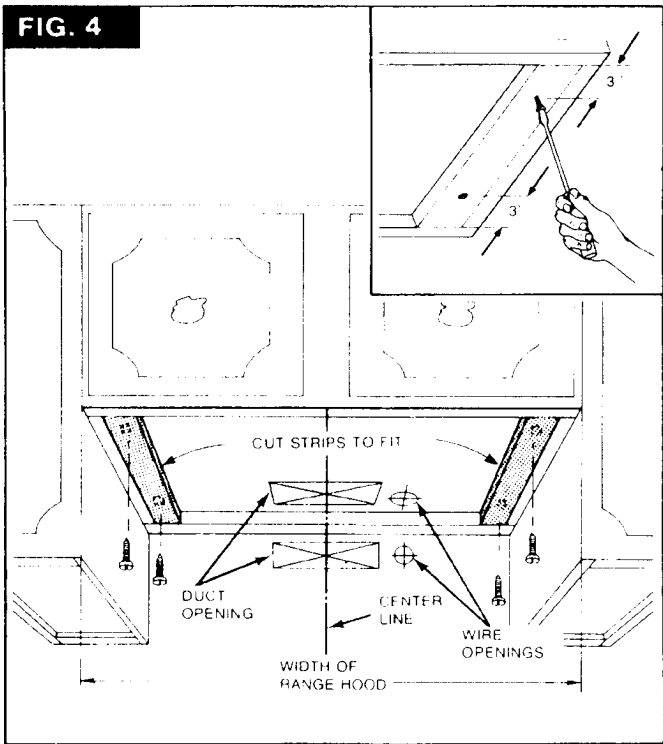

NOTE

If distance between wall and front of cabinet face frame is more than 12", there will be a gap between back of hood and wall. This is normal. Top front edge of hood should be flush with front of cabinet face frame. OMIT STEP 1 if hood will be installed under cabinets with flush bottom.

1. **For Cabinets With Recessed Bottoms ONLY:** (FIG. 4) Install wood filler strips on each side of recessed area under cabinet. Use two 1" x 2" strips cut to length (use thicker strips if necessary). Fasten strips with wood screws about 3" in from each end.
2. Measure and mark the following: (FIG. 5)
 - a.) electrical wiring opening
 - b.) duct opening
3. Cut duct opening in wall or cabinet bottom.
4. Drill 1-1/4" electrical wiring opening in wall or cabinet bottom.
5. Hold hood up against cabinet bottom and trace keyhole slots onto cabinet bottom or filler strips. For larger hoods: Two 1/4" dia. holes are provided for secure mounting. They are located in top of hood approx. 8" each side of center. Add filler strips for these as necessary. Avoid blocking hood's vertical electrical knockout.
6. Screw four 7/8" wood screws from parts bag into exact center of narrow end of keyhole slots marked on cabinet bottom. Allow 3/8" of screws to project, so hood can be fitted into place later.
7. Run electric wiring through hole drilled in wall or cabinet. Provide 6" leads and install proper connector for type of wire used.

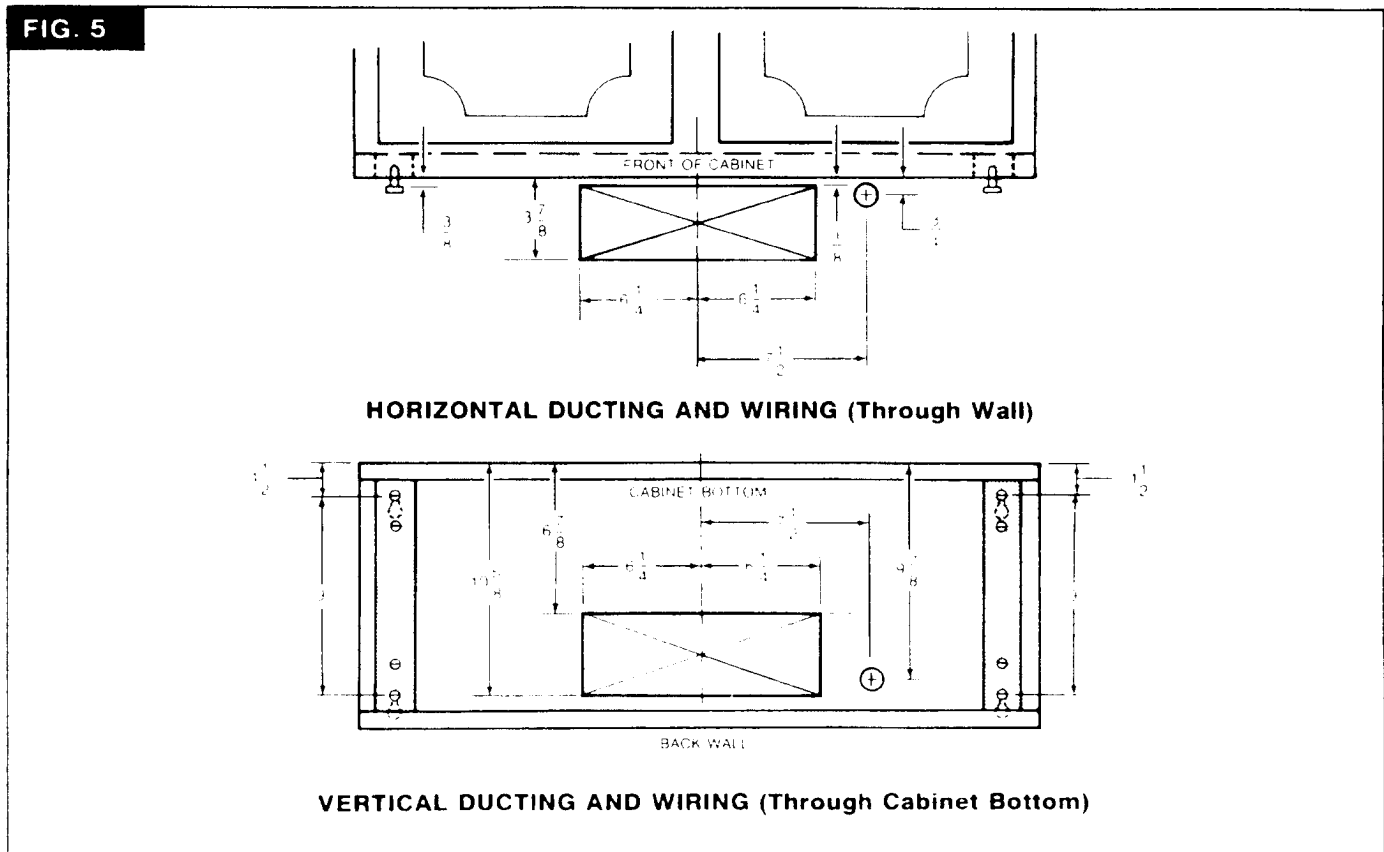

INSTALL THE DUCTWORK

NOTE

These instructions will follow the plans made on page 2. Start on the outside and work back toward hood. Follow appropriate directions for type of duct system you are installing.

WALL CAPS (FIG. 6)

Use a saber saw to cut a hole slightly larger than duct so duct will line up easily with hood. Install casing strips on outside walls finished in siding. Assemble the ductwork and tape all joints. Run ductwork back to hood. Fasten wall cap to last section of duct and nail or screw cap to wall. Seal all around flange on wall cap with caulking compound. Make sure that enough duct runs into the room so that the duct will overlap the damper/duct connector by 3/4" when the hood is installed.

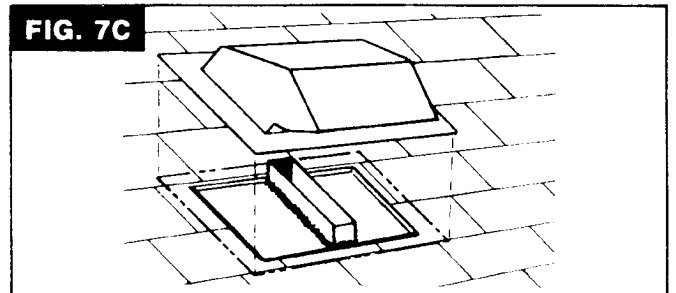
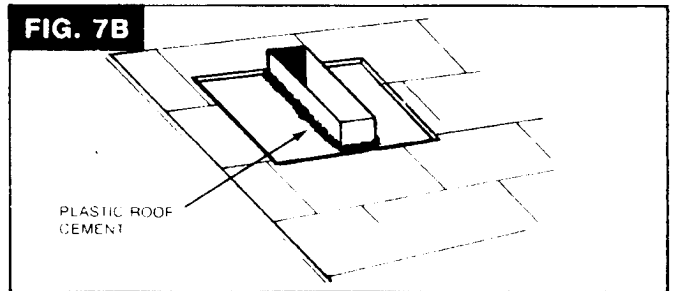
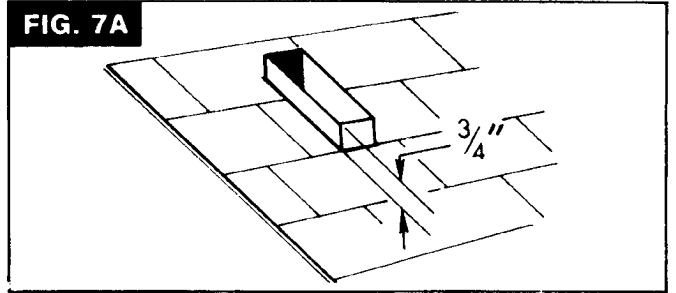
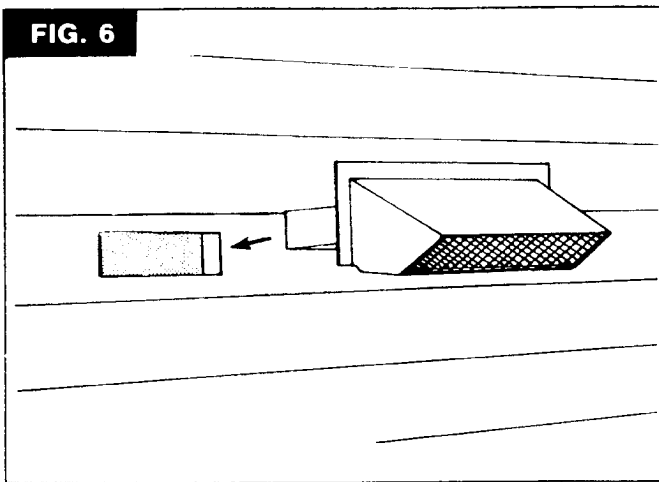

ROOF CAPS (FIG. 7)

Cut hole in roof slightly larger than duct so duct will line up easily with hood. Trim shingles around hole so that they will fit snugly around hood of cap when cap is installed. Assemble the ductwork and tape all joints. Run the ductwork down to hood. Trim duct parallel to roof pitch, leaving 3/4" of duct projecting above roof (FIG. 7A). Seal all around duct with roof cement (FIG. 7B). Install roof cap, inserting back edge of cap under shingles (FIG. 7C). Seal around cap with roof cement and seal all nail heads and shingles which were cut or lifted (FIG. 7D).

Make sure that enough duct runs into the room so that the duct will overlap the damper/duct connector by 3/4" when the hood is put into place.

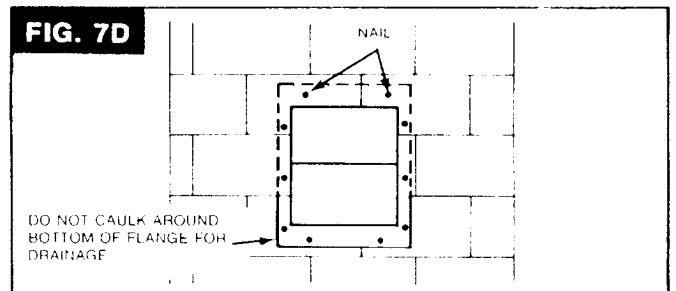

INSTALL HOOD

1. Position hood so that: (FIG. 8)
 - a.) electrical wiring runs through opening in top or back of hood
 - b.) large part of keyhole slots fit over hood mounting screws
 - c.) damper/duct connector slides into ductwork

FIG. 8

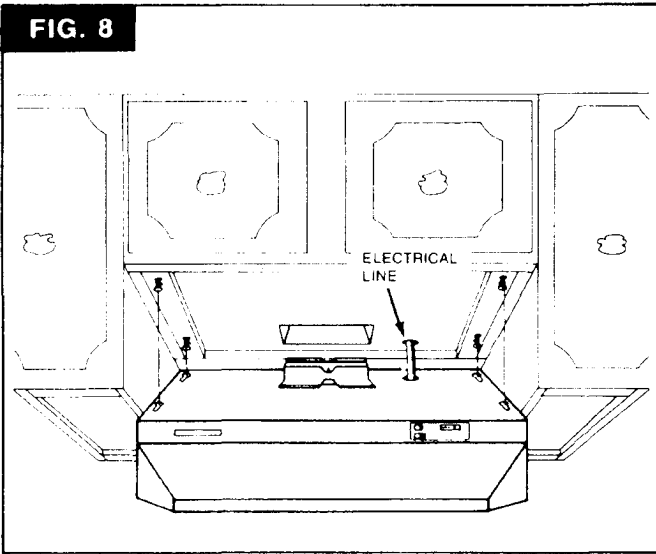

2. Push hood back so that mounting screws slide into narrow end of keyhole slots. When mounting larger hoods, run (2) screws through the 1/4" dia. holes (in hood top and 8" each side of center) and into the cabinet bottom or added filler strips. Tighten all screws firmly.
3. Install locknut on electrical connector and tighten securely.
4. Make electrical connections. Connect white to white, black to black and green or bare wire to green ground screw. (FIG. 9)

FIG. 9

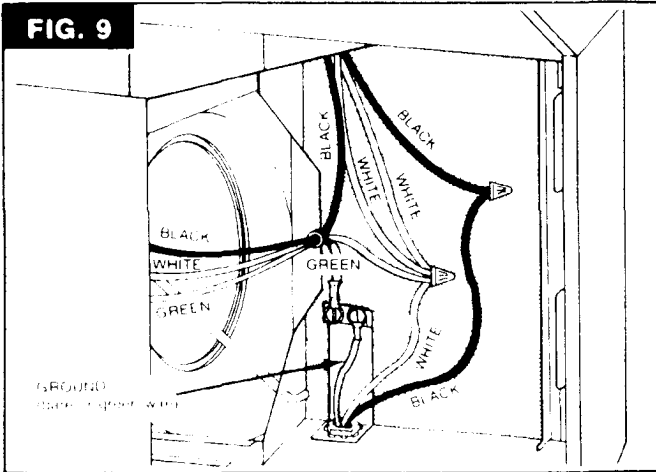

5. Replace wiring box cover and screws. Do not pinch wiring between hood and box.
6. Install two 75 watt bulbs, or one 75 watt and one 25 watt bulb for night-light use. Install 25 watt bulb in right-hand socket. Reinstall light lens.
7. Reinstall blower. **Do not grasp blower by blower wheels.** Position blower so that blower discharge lines up with damper/duct connector. (FIG. 10) Slip mounting rods into brackets on blower assembly and tighten knurled nuts securely. Plug in blower.

FIG. 10

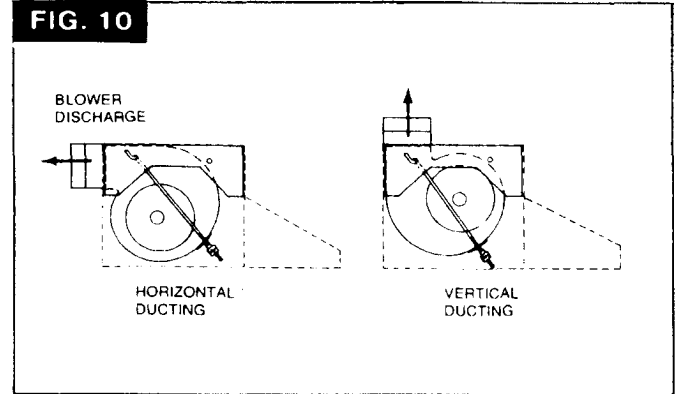

8. Reinstall bottom cover and screws. Refer to FIG. 2.
9. Install filters. Make sure that tab on filter is toward outside and bottom. (FIG. 11)
10. Turn on power and check operation of blower and light.

FIG. 11

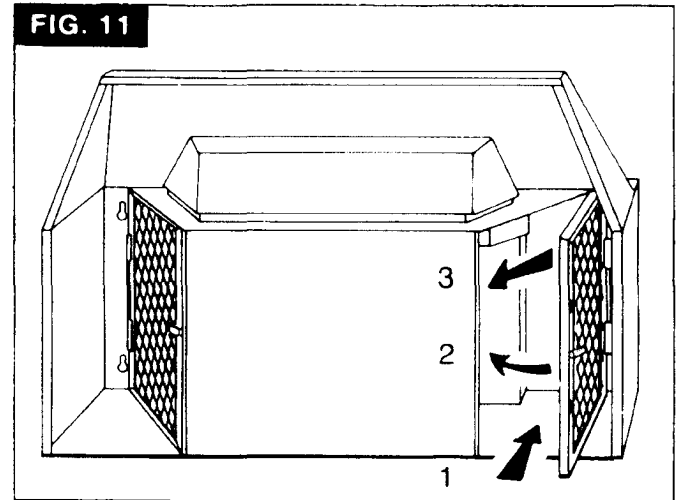

USE AND CARE

Always turn your hood on before you begin cooking to establish an air flow in the kitchen. Let the hood run for a few minutes to clear the air after you turn the range off. This will help keep the whole kitchen cleaner and brighter.

CONTROLS (FIG. 12)

SPEED - Infinite speed slide control controls blower speed and sound levels.

BLOWER - Turns blower "ON" and "OFF". When blower is turned "OFF", Air Speed Control remains at pre-set speed. When blower is turned on again, it will return to the previously chosen setting.

LIGHT - Turns light "ON" and "OFF". First position turns on both bulbs for normal lighting. Second position turns off one bulb, so that by combining a 75 watt and 25 watt bulb, you have a night light system. Third position turns both bulbs "OFF". Maximum bulb rating is 75 watts. Do not install bulbs rated higher than 75 watts.

HEAT SENTRY™ SAFETY FEATURE

Your hood is equipped with a Heat Sentry™ thermostat. This safety device will turn on or speed up the blower if it senses excess heat above the cooking surface.

If the blower is not on, or if it is running at low speed, the Heat Sentry™ will override the normal blower control and turn the blower on to high speed. When the temperature level drops to normal levels the blower will return to its original setting.

FILTERS

Remove filter by grasping filter tab and lifting filter up into recess at top of filter channel. Swing bottom of filter out to remove.

Filters should be cleaned frequently with a detergent solution. They are also dishwasher safe.

CLEANING

Use a mild detergent suitable for painted surfaces. DO NOT USE ABRASIVE CLOTH, STEEL WOOL PADS, OR SCOURING POWDERS. Vacuum blower to clean. Do not immerse blower in water.

FIG. 12

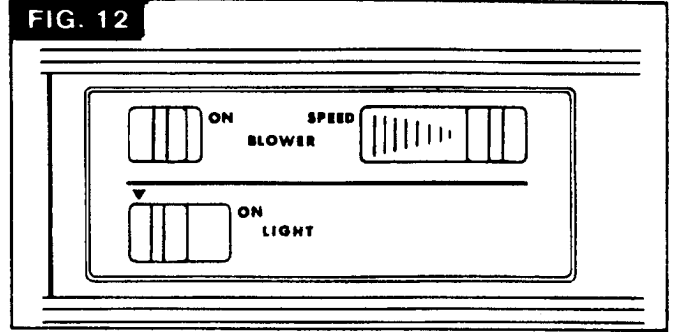
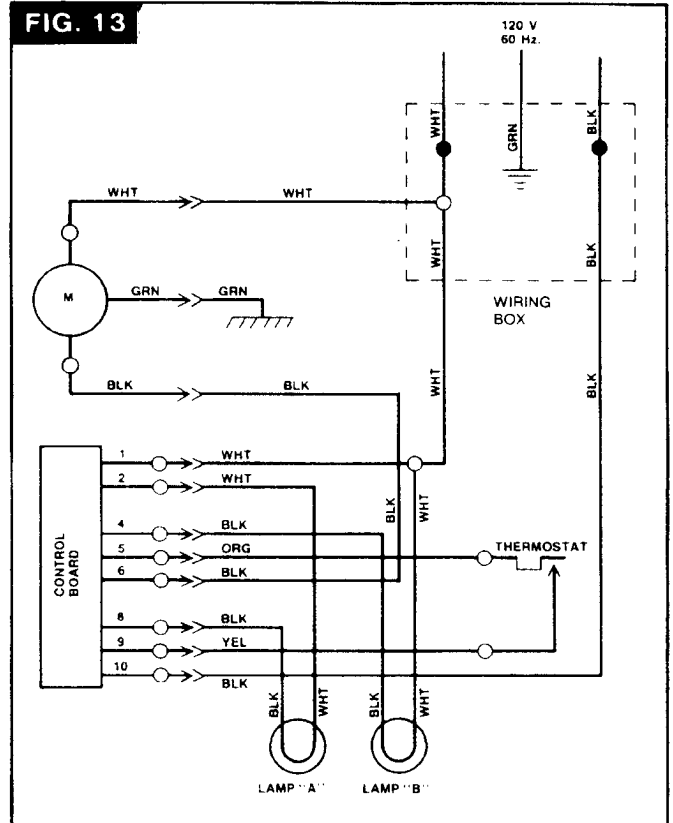
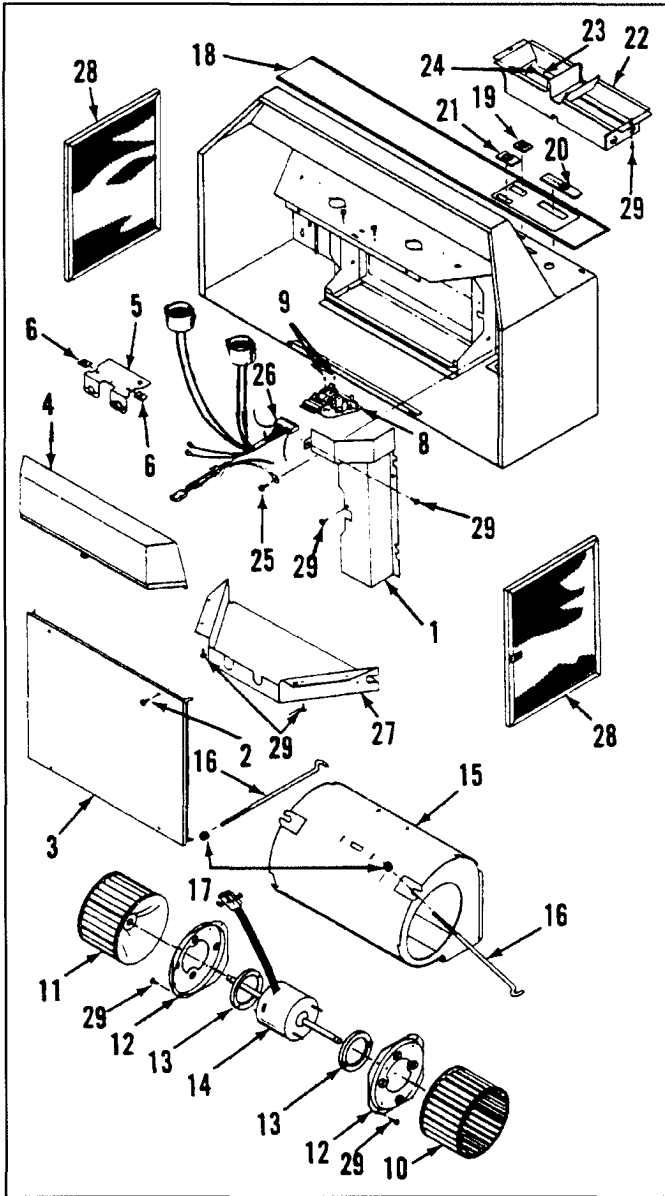

FIG. 13





SERVICE PARTS 89000 Series Deluxe Ducted Range Hood



KEY NO.	PART NO.	DESCRIPTION
1	97007656	Wiring Box Cover
2	-----	#8-18 x 3/8 Phillips Truss Head Screws (4 req.)*
3	97007895	Bottom Cover, White
	97007898	Bottom Cover, Harvest
	97007899	Bottom Cover, Almond
	97007631	Bottom Cover, Silver (for Stainless Steel)
	97015498	Bottom Cover, Biscuit
	97009517	Bottom Cover, Black
4	99110605	Light Lens
5	97007901	Thermostat Assembly
6	93260454	Sheet Metal Nuts "U" Type
8	97011801	Control Board Assembly
9	-----	#6B-20 Phillips Flat Head Screws (2 req.)*
10	99020142	Blower Wheel, Clockwise
11	99020143	Blower Wheel, Counterclockwise
12	98005212	Motor Retaining Ring
13	99100439	Rubber Vibration Ring
14	97007729	Motor
15	97007313	Blower Scroll Housing
16	99420464	Blower Mounting Rod
17	99260476	Blower Mounting Rod Nut
18	97007657	Control Panel - Black (30", 33" wide hoods)
	97013360	Control Panel - White (30" wide hoods)
	97015568	Control Panel - Biscuit (30" wide hoods)
	97007658	Control Panel - Black (36", 39" wide hoods)
	97013976	Control Panel - White (36" wide hoods)
	97015569	Control Panel - Biscuit (36" wide hoods)
	97007659	Control Panel - Black (42" wide hoods)
	97013977	Control Panel - White (42" wide hoods)
	97015570	Control Panel - Biscuit (42" wide hoods)
	97007660	Control Panel - Black (48" wide hoods)
	97013361	Control Panel - White (48" wide hoods)
19	95000924	Blower Knob - Black
	95000925	Blower Knob - White
	95001058	Blower Knob - Biscuit
20	99111127	Speed Control Knob - Black
	99111128	Speed Control Knob - White
	99111214	Speed Control Knob - Biscuit
21	99111123	Light Switch Knob - Black
	99111124	Light Switch Knob - White
	99111215	Light Switch Knob - Biscuit
22	97006078	Damper Assembly (Includes Key Nos. 23 & 24)
23	98005221	Damper Flap
24	99100379	Damper Bushing
25	-----	#10-32 x 1/2 Green Ground Screw*
26	97007570	Wire Harness
27	98006546	Bulb Holder Cover
28	97007894	Aluminum Filter Kit (contains 2 filters)
29	-----	#8B x 3/8 Hex Head Sheet Metal Screws (13 req.)*
**	97007542	Blower Assembly Complete (Includes Key Nos. 10-15, 29)

*Standard Hardware. May be purchased locally. ** Not Illustrated.

BROAN ONE YEAR LIMITED WARRANTY

Broan warrants to the original consumer purchaser of its products that such products will be free from defects in materials or workmanship for a period of one year from the date of original purchase. THERE ARE NO OTHER WARRANTIES, EXPRESS OR IMPLIED, INCLUDING, BUT NOT LIMITED TO, IMPLIED WARRANTIES OF MERCHANTABILITY OR FITNESS FOR A PARTICULAR PURPOSE.

During this one-year period, Broan will, at its option, repair or replace, without charge, any product or part which is found to be defective under normal use and service. THIS WARRANTY DOES NOT EXTEND TO FLUORESCENT LAMP STARTERS AND TUBES. This warranty does not cover (a) normal maintenance and service or (b) any products or parts which have been subject to misuse, negligence, accident, improper maintenance or repair (other than by Broan), faulty installation or installation contrary to recommended installation instructions.

The duration of an implied warranty is limited to the one-year period as specified for the express warranty. Some states do not allow limitation on how long an implied warranty lasts, so the above limitation may not apply to you.

BROAN'S OBLIGATION TO REPAIR OR REPLACE, AT BROAN'S OPTION, SHALL BE THE PURCHASER'S SOLE AND EXCLUSIVE REMEDY UNDER THIS WARRANTY. BROAN SHALL NOT BE LIABLE FOR INCIDENTAL, CONSEQUENTIAL OR SPECIAL DAMAGES ARISING OUT OF OR IN CONNECTION WITH PRODUCT USE OR PERFORMANCE. Some states do not allow the exclusion or limitation of incidental or consequential damages, so the above limitation may not apply to you.

This warranty gives you specific legal rights, and you may also have other rights, which vary from state to state. This warranty supersedes all prior warranties.

To qualify for warranty service, you must (a) notify Broan at the address stated below or telephone: 1-800-637-1453, (b) give the model number and part identification and (c) describe the nature of any defect in the product or part. At the time of requesting warranty service, you must present evidence of the original purchase date.

Broan-NuTone LLC, 926 West State Street Hartford, WI 53027 (1-800-637-1453)