

This Owner's Manual is provided and hosted by [Appliance Factory Parts](#).



BROAN 153623 Owner's Manual

[Shop genuine replacement parts for BROAN 153623](#)



[Find Your BROAN HVAC Parts - Select From 1309 Models](#)

----- Manual continues below -----

BROAN ELITE 15000 SERIES (*Silhouette*®) RANGE HOODS

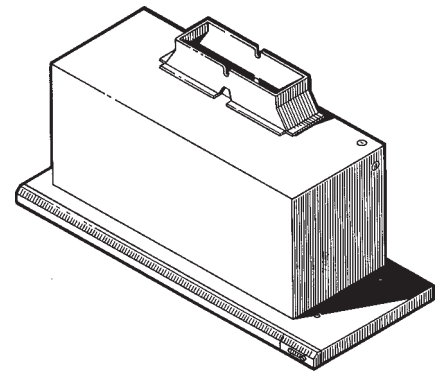

Mounts into a full-sized cabinet above the cooktop with only a slim, sliding glass drawer visible to accent today's contemporary and European-styled kitchens.

FEATURES

- High efficiency dual centrifugal blower with resilient anti-vibration motor mounts
- Blower turns ON when drawer is partially pulled out - OFF when closed
- Front-mounted solid state infinite speed control with memory
- Heat Sentry™ - Automatically turns blower ON to HIGH speed when excess heat is detected
- Bright, economical 24" fluorescent light (F20T12 tube not included)
- Prismatic glass light lens - removes easily for cleaning
- Light turns ON when drawer is pulled out slightly - OFF when closed
- Drawer handle permanently bonded to tempered glass
- Drawer glides in and out smoothly and precisely - removes for cleaning
- Washable foam filter
- Installs in standard 30" or 36" wide, flush or recessed bottom-styled cabinets
- Compact blower housing - permits use of cabinet shelf space
- Includes damper/duct connector
- Choice of 3 colors and 2 sizes:

Model 153001 30" White	Model 153601 36" White
Model 153023 30" Black	Model 153623 36" Black
Model 153002 30" Biscuit	Model 153602 36" Biscuit
Model 153004 30" Stainless Look Brushed Alluminum	Model 153604 36" Stainless Look Brushed Alluminum

SPECIFICATIONS

MODEL	VOLTS	AMPS	SONES	CFM	DUCT	SHIPPING WT.
1530	120	3.7	4.5	300	3¼" x 10"	40 Lbs.
1536	120	3.7	4.5	300	3¼" x 10"	43 Lbs.



HVI-2100 CERTIFIED RATINGS comply with new testing technologies and procedures prescribed by the Home Ventilating Institute, for off-the-shelf products, as they are available to consumers. Product performance is rated at 0.1 in. static pressure, based on tests conducted in AMCA's state-of-the-art test laboratory. Sones are a measure of humanly-perceived loudness, based on laboratory measurements.

TYPICAL SPECIFICATION

Range Hood shall be Broan Elite 15000 Series.

Unit shall be constructed of heavy-gauge steel finished with a durable, black, (white), (biscuit) painted finish. It will install in a standard 30" (or wider) cabinet with a flush or recessed bottom.

Hood to contain a quiet efficient centrifugal blower with automatic start-up at high temperatures. It shall be ducted vertically through 3¼" x 10" ductwork. Blower and fluorescent light shall be turned ON and OFF using a sliding, tempered glass drawer. An infinite speed control, with memory, shall be provided to adjust blower speed.

Air delivery shall be no less than 300 CFM and sound level no greater than 4.5 Sones. All air and sound ratings shall be certified by HVI.

Unit to be U.L. listed.

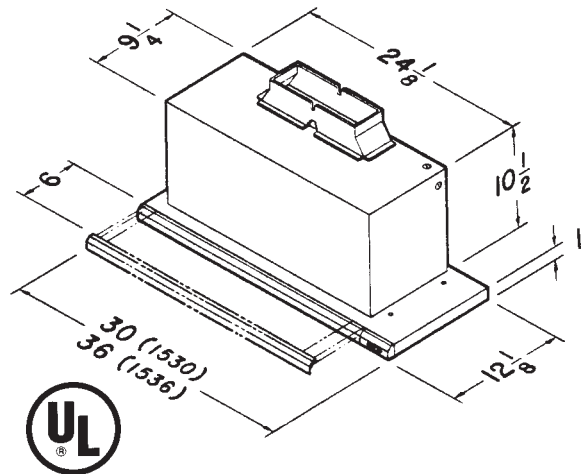

Broan-NuTone LLC, 926 West State Street, Hartford, WI 53027 (1-800-637-1453)
NuTone, Inc., 4820 Red Bank Road, Cincinnati, OH 45227 (1-800-543-8687)

REFERENCE	QTY.	REMARKS	Project	
			Location	
			Architect	
			Engineer	
			Contractor	
			Submitted by	Date