

This Owner's Manual is provided and hosted by [Appliance Factory Parts](#).



BROAN 423608 Owner's Manual

[Shop genuine replacement parts for BROAN 423608](#)



[Find Your BROAN HVAC Parts - Select From 1309 Models](#)

----- Manual continues below -----

42000 SERIES TWO-SPEED 7" ROUND RANGE HOOD

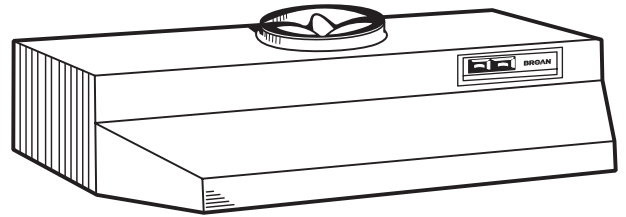

Quality construction and ease of installation make the 42000 the popular choice in vertically-ducted economy hoods.

FEATURES

- Rocker-type fan and light switches
- Polymeric blade and light lens (accepts up to 75W bulb)
- Washable aluminum filter
- Mitered sides and hemmed bottom for safety and good looks
- Model BP87 double-leaf damper (available separately)
- Contemporary styling in White, Almond and Stainless Steel
- Available in 30" and 36" widths
- **Special Order Color** - Black (30" and 36" only)
- **Special Order Size** - 24" and 42" (White, Biscuit, Almond and Stainless Steel only)

SPECIFICATIONS

VOLTS	AMPS	RPM	SONES	CFM	DUCT
120	2.0	1750	6.0	190	7" Round



HVI-2100 CERTIFIED RATINGS comply with new testing technologies and procedures prescribed by the Home Ventilating Institute, for off-the-shelf products, as they are available to consumers. Product performance is rated at 0.1 in. static pressure, based on tests conducted in AMCA's state-of-the-art test laboratory. Sones are a measure of humanly-perceived loudness, based on laboratory measurements.



TYPICAL SPECIFICATION

Range hood shall be Broan Model 42000.

Unit shall be ducted vertically into 7" round ductwork.

Motor to be permanently lubricated. RPM not to exceed 2750.

Unit shall have two-speed fan switch and separate light switch.

Sides shall be mitered and bottom edge hemmed - with no sharp edges.

Air delivery shall be no less than 190 CFM and sound level no greater than 6.0 sones. All air and sound ratings shall be certified by HVI.

Unit shall be U.L. listed.

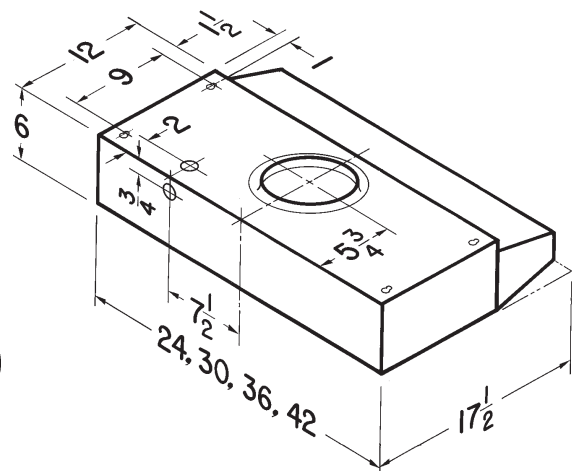

Broan-NuTone LLC, 926 West State Street, Hartford, WI 53027 (1-800-637-1453)

REFERENCE	QTY.	REMARKS	Project
			Location
			Architect
			Engineer
			Contractor
			Submitted by Date