

This Owner's Manual is provided and hosted by [Appliance Factory Parts](#).



BROAN 523002 Owner's Manual

[Shop genuine replacement parts for BROAN 523002](#)



[Find Your BROAN HVAC Parts - Select From 1309 Models](#)

----- Manual continues below -----

52000 SERIES TWO-SPEED 5" ROUND RANGE HOOD

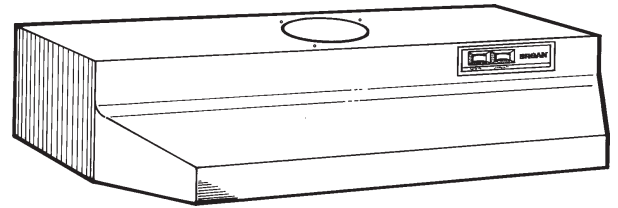

Quality construction and ease of installation make the 52000 the popular choice in vertically-ducted economy hoods for manufactured housing.

FEATURES

- Two speed fan control
- Polymeric blade and light lens (accepts up to 75W bulb)
- Washable aluminum filter
- Mitered sides and hemmed bottom for safety and good looks
- Contemporary styling in White and Almond
- Available in 30", 36" and 42" widths
- .019/.021 CRS

Designed by Broan for use with this product (available separately):

- Model P85 double-leaf damper (shown on other side)

TYPICAL SPECIFICATION

Range hood shall be Broan Model 52000.

Unit shall be ducted vertically into 5" round ductwork.

Motor to be permanently lubricated. RPM not to exceed 2900.

Unit shall have two-speed fan switch and separate light switch.

Sides shall be mitered and bottom edge hemmed - with no sharp edges.

Air delivery shall be no less than 100 CFM. Air ratings shall be certified by HVI.

Unit shall meet all HUD requirements for Range Hoods.

Unit shall be U.L. listed.

SPECIFICATIONS

VOLTS	AMPS	RPM	SONES	CFM	DUCT
120	2.0	2700	8.0	100	5" Round



HVI-2100 CERTIFIED RATINGS comply with new testing technologies and procedures prescribed by the Home Ventilating Institute, for off-the-shelf products, as they are available to consumers. Product performance is rated at 0.1 in. static pressure, based on tests conducted in AMCA's state-of-the-art test laboratory. Sones are a measure of humanly-perceived loudness, based on laboratory measurements.

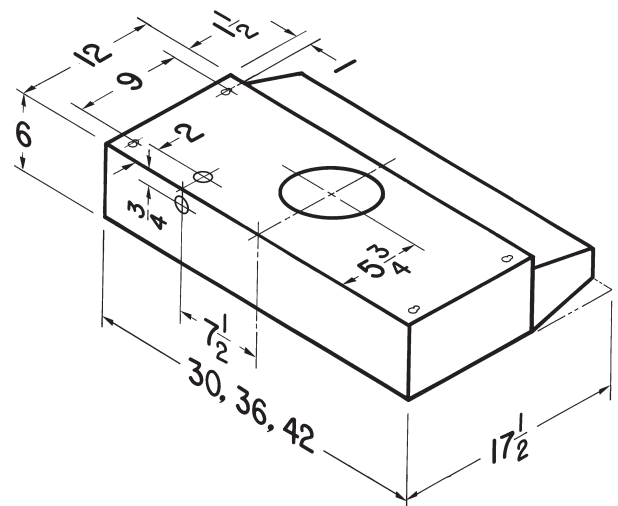

Broan-NuTone LLC, 926 West State Street, Hartford, WI 53027 (1-800-637-1453)

REFERENCE	QTY.	REMARKS	Project
			Location
			Architect
			Engineer
			Contractor
			Submitted by Date

PERFORMANCE RATINGS

MODEL 52000

TWO-SPEED 5" ROUND RANGE HOOD

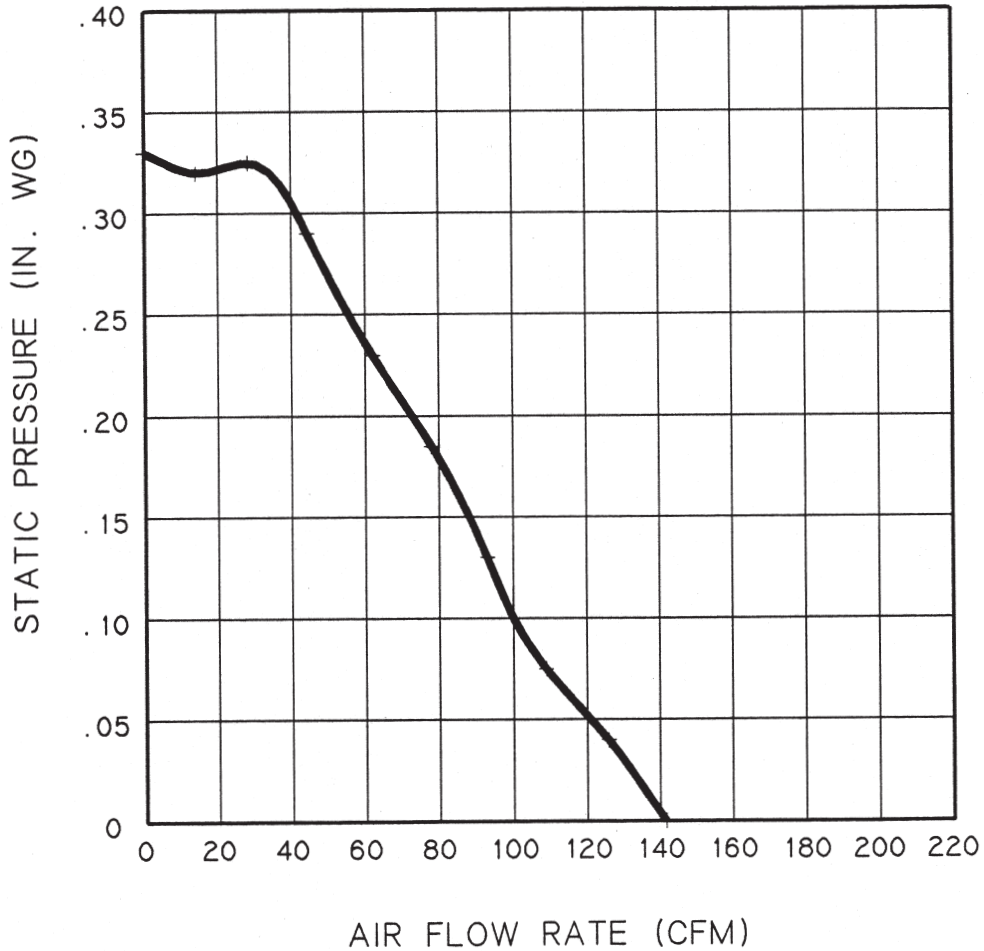

MODEL P85

INTEGRATED 5" ROUND TRANSITION/DAMPER

- Intended to be used with all 5" ducting
- Double-leaf damper
- Mounts directly with three screws to pre-drilled holes on 52000 Series range hood

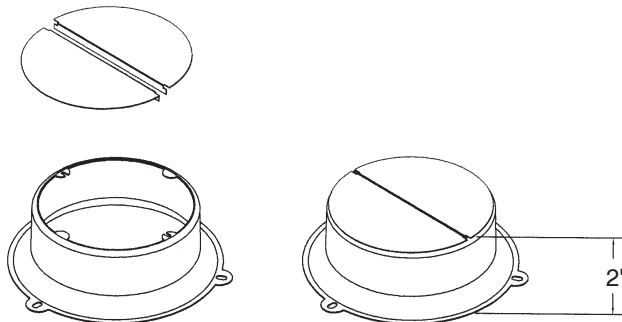

Broan-NuTone LLC, 926 West State Street, Hartford, WI 53027 (1-800-637-1453)