

This Owner's Manual is provided and hosted by [Appliance Factory Parts](#).



BROAN 523008 Owner's Manual

[Shop genuine replacement parts for BROAN 523008](#)



[Find Your BROAN HVAC Parts - Select From 1309 Models](#)

----- Manual continues below -----

BROAN®

52000 SERIES

USE AND CARE MANUAL

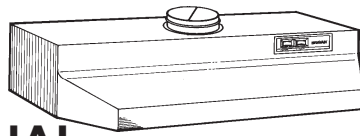

To register this product visit www.broan.com

READ AND SAVE THESE INSTRUCTIONS

⚠ INTENDED FOR DOMESTIC COOKING ONLY ⚠

WARNING ⚠ ⚠

TO REDUCE THE RISK OF A RANGE TOP GREASE FIRE:

1. Never leave surface units unattended at high settings. Boilovers cause smoking and greasy spillovers that may ignite. Heat oils slowly on low or medium settings.
2. Always turn hood ON when cooking at high heat or when cooking flaming foods.
3. Clean ventilating fans frequently. Grease should not be allowed to accumulate on fan or filter.
4. Use proper pan size. Always use cookware appropriate for the size of the surface element.

TO REDUCE THE RISK OF INJURY TO PERSONS IN THE EVENT OF A RANGE TOP GREASE FIRE, OBSERVE THE FOLLOWING:*

1. SMOTHER FLAMES with a close-fitting lid, cookie sheet, or metal tray, then turn off the burner. BE CAREFUL TO PREVENT BURNS. If the flames do not go out immediately, EVACUATE AND CALL THE FIRE DEPARTMENT.
2. NEVER PICK UP A FLAMING PAN - You may be burned.
3. DO NOT USE WATER, including wet dishcloths or towels - a violent steam explosion will result.
4. Use an extinguisher ONLY if:
 - A. You know you have a Class ABC extinguisher and you already know how to operate it.
 - B. The fire is small and contained in the area where it started.
 - C. The fire department is being called.
 - D. You can fight the fire with your back to an exit.

* Based on "Kitchen Fire Safety Tips" published by NFPA.

TO REDUCE THE RISK OF FIRE, ELECTRIC SHOCK, OR INJURY TO PERSONS, OBSERVE THE FOLLOWING:

1. Use this unit only in the manner intended by the manufacturer. If you have questions, contact the manufacturer at the address or telephone number listed in the warranty.

WARNING ⚠ ⚠

2. Before servicing or cleaning unit, switch power off at service panel and lock the service disconnecting means to prevent power from being switched on accidentally. When the service disconnecting means cannot be locked, securely fasten a prominent warning device, such as a tag, to the service panel.
3. Installation work and electrical wiring must be done by a qualified person(s) in accordance with all applicable codes and standards, including fire-rated construction codes and standards.
4. Sufficient air is needed for proper combustion and exhausting of gases through the flue (chimney) of fuel burning equipment to prevent backdrafting. Follow the heating equipment manufacturer's guideline and safety standards such as those published by the National Fire Protection Association (NFPA), and the American Society for Heating, Refrigeration and Air Conditioning Engineers (ASHRAE), and the local code authorities.
5. When cutting or drilling into wall or ceiling, do not damage electrical wiring and other hidden utilities.
6. Ducted fans must always be vented to the outdoors.
7. Do not use this range hood with an additional speed control device.
8. To reduce the risk of fire, use only metal ductwork.
9. Use with approved cord-connection kit only.
10. This unit must be grounded.

CAUTION ⚠

1. For general ventilating use only. Do not use to exhaust hazardous or explosive materials and vapors.
2. To avoid motor bearing damage and noisy and/or unbalanced impellers, keep drywall spray, construction dust, etc. off power unit.
3. For best capture of cooking impurities, your range hood should be mounted 18-24" above the cooking surface.
4. Please read specification label on product for further information and requirements.

SWITCHES

The fan and light are each controlled by a rocker switch. The light switch has two positions, "ON" and "OFF." The fan switch has three positions - "HIGH," "LOW" and "OFF." ("OFF" is the middle position.)



WARNING

ALWAYS DISCONNECT ELECTRIC POWER BEFORE SERVICING RANGE HOOD.

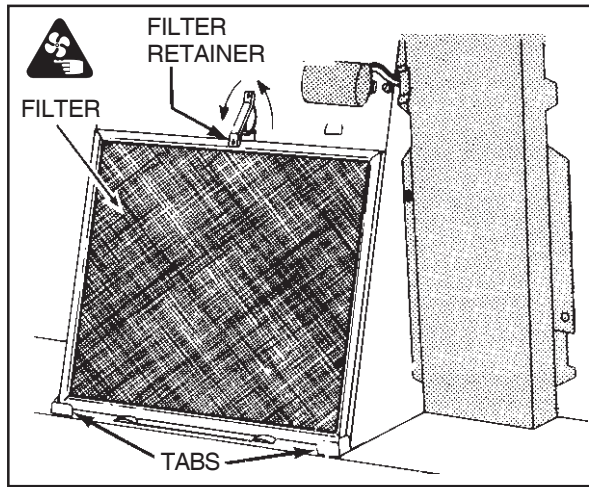

FILTER

Remove aluminum filter by turning filter retainer to one side. Filter should be washed once a month in a hot detergent solution. Aluminum filters are dishwasher safe. When installing filter, make sure that filter slides under retaining tabs on back of fan housing. Turn filter retainer so that arrows on retainer point toward front and back of hood.

FAN ASSEMBLY

Remove filter. Remove two screws holding motor bracket to range hood, and unplug fan assembly. Be careful not to allow fan assembly to drop when screws are removed.

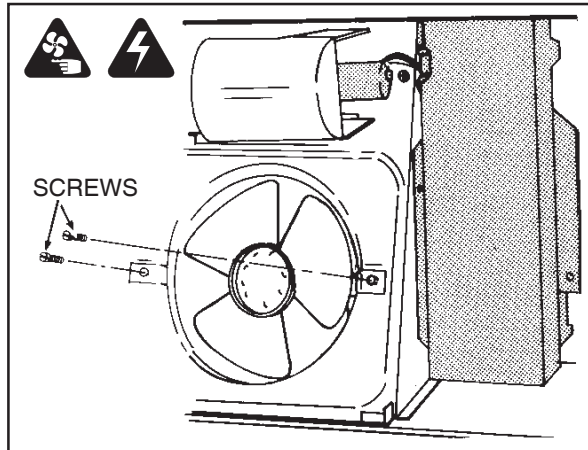

CLEANING

Clean your hood with a mild detergent suitable for painted surfaces. **DO NOT USE ABRASIVE CLOTH, STEEL WOOL PADS OR SCOURING POWDERS.**

Fan assembly may be vacuumed. Fan assembly is permanently lubricated, and never needs oiling.

SERVICE PARTS

52000 SERIES RANGE HOOD

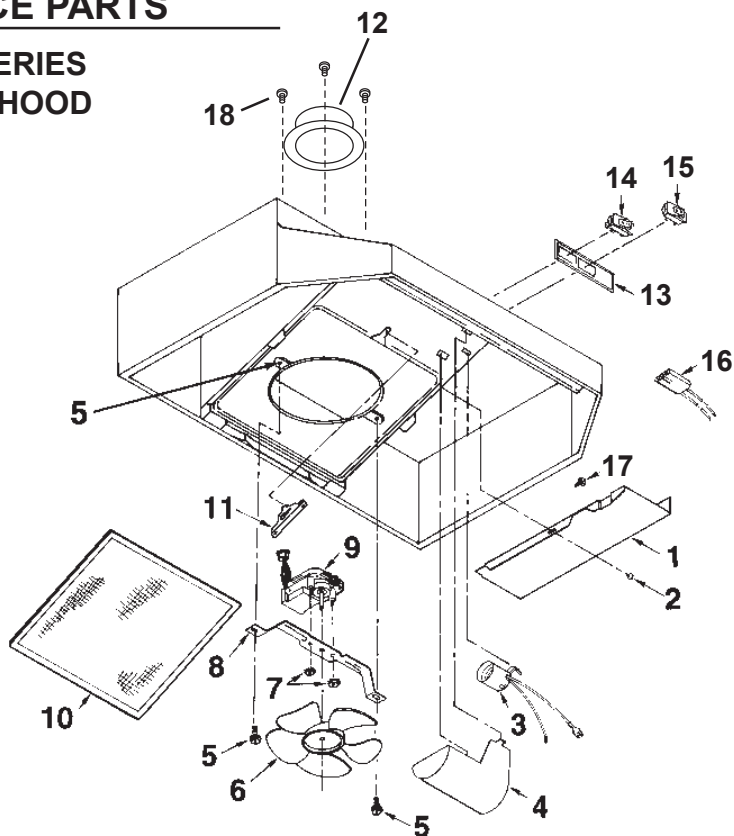

KEY NO.	PART NO.	DESCRIPTION
1	98006621	Outlet Box Cover
2	99170245	#8 x 3/8 Sheet Metal Screw*
3	99270987	Bulb Holder with Wires
4	99110437	Light Lens
5	97011217	Screw/Nut Kit (Includes 2 - #10-16 x .500 screws and 2 - #10-16 sheet metal nuts)
6	99020272	Fan Blade
7	99260428	#6-32 Locking Nuts* (2 Required)
8	98005568	Motor Mounting Bracket
9	97014665	Motor Assembly (Includes Key Nos. 6, 7, & 8)
10	97006931	Aluminum Filter
11	99420472	Filter Retainer
12	97014729	Damper Assembly
13	97010709	Nameplate - Black
	99090881	Nameplate - White
14	97016970	2-Speed Motor Switch - Black (Includes Key No. 18)
	97016971	2-Speed Motor Switch - White (Includes Key No. 18)
15	97016970	Light Switch - Black (Includes Key No. 17)
	97016971	Light Switch - White (Includes Key No. 17)
16	97005678	Motor Receptacle with Wires
17	99150471	#10-32 x 1/2 Green Ground Screw*
18	99150470	#8 x 3/8 Sheet Metal Screw, AB Point*
**	----	Light Bulb, 75 Watt (not included)*

Order service parts by "PART NO." - NOT by "KEY NO."

* Standard Hardware. May be purchased locally.

** Not Illustrated.

WARRANTY

BROAN-NUTONE ONE YEAR LIMITED WARRANTY

Broan-NuTone warrants to the original consumer purchaser of its products that such products will be free from defects in materials or workmanship for a period of one year from the date of original purchase. THERE ARE NO OTHER WARRANTIES, EXPRESS OR IMPLIED, INCLUDING, BUT NOT LIMITED TO, IMPLIED WARRANTIES OF MERCHANTABILITY OR FITNESS FOR A PARTICULAR PURPOSE.

During this one-year period, Broan-NuTone will, at its option, repair or replace, without charge, any product or part which is found to be defective under normal use and service.

THIS WARRANTY DOES NOT EXTEND TO FLUORESCENT LAMP STARTERS AND TUBES. This warranty does not cover (a) normal maintenance and service or (b) any products or parts which have been subject to misuse, negligence, accident, improper maintenance or repair (other than by Broan-NuTone), faulty installation or installation contrary to recommended installation instructions.

The duration of any implied warranty is limited to the one-year period as specified for the express warranty. Some states do not allow limitation on how long an implied warranty lasts, so the above limitation may not apply to you.

BROAN-NUTONE'S OBLIGATION TO REPAIR OR REPLACE, AT BROAN'S OPTION, SHALL BE THE PURCHASER'S SOLE AND EXCLUSIVE REMEDY UNDER THIS WARRANTY. BROAN-NUTONE SHALL NOT BE LIABLE FOR INCIDENTAL, CONSEQUENTIAL OR SPECIAL DAMAGES ARISING OUT OF OR IN CONNECTION WITH PRODUCT USE OR PERFORMANCE. Some states do not allow the exclusion or limitation of incidental or consequential damages, so the above limitation or exclusion may not apply to you.

This warranty gives you specific legal rights, and you may also have other rights, which vary from state to state. This warranty supersedes all prior warranties.

To qualify for warranty service, you must (a) notify Broan-NuTone at the address or telephone number below, (b) give the model number and part identification and (c) describe the nature of any defect in the product or part. At the time of requesting warranty service, you must present evidence of the original purchase date.

Broan-NuTone LLC, 926 West State Street, Hartford, WI 53027 (1-800-637-1453)