

This Owner's Manual is provided and hosted by [Appliance Factory Parts](#).



BROAN GSHH3K Owner's Manual

[Shop genuine replacement parts for BROAN GSHH3K](#)



[Find Your BROAN HVAC Parts - Select From 1309 Models](#)

----- Manual continues below -----

BROAN®

FRESH AIR SYSTEMS

USER MANUAL

HEPA Filtration and
Fresh Air
Ventilation*
GSVH1K

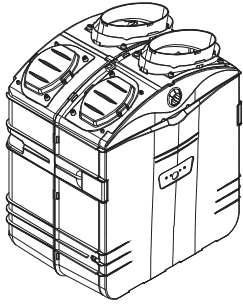
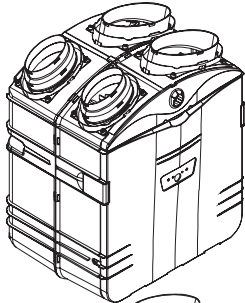

HEPA
Filtration*
GSFH1K

VB0061

*Patents pending

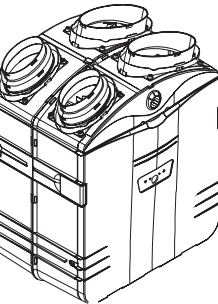

HEPA Filtration,
Fresh Air and
Heat Recovery
Ventilation*
GSHH3K

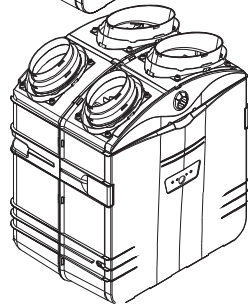

HEPA Filtration,
Fresh Air and
Energy Recovery
Ventilation*
GSEH3K

RESIDENTIAL USE ONLY.

INSTALLER: LEAVE THIS MANUAL WITH CONSUMER.



7 72371 07963 2

REGISTER YOUR PRODUCT ON LINE AT:

www.broan.com/register

For additional information - visit www.Broan.com

05690 rev. 5

Broan-NuTone LLC

99043224

ABOUT THIS MANUAL

Congratulations! Your purchase of this whole-house HEPA filtration, with optional ventilation will allow you and your family to enjoy clean and healthy air throughout your home for years to come!

Please read this booklet thoroughly.

Several models are described in this publication. Some details of your unit may be slightly different than the ones shown, as the illustrations are typical ones.

This manual uses the following symbols to emphasize particular information:

⚠ WARNING

Identifies an instruction which, if not followed, might cause serious personal injuries including possibility of death.

CAUTION

Denotes an instruction which, if not followed, may severely damage the unit and/or its components.

NOTE: Indicates supplementary information needed to fully complete an instruction.

We welcome any suggestions concerning this manual and/or the product, or ways to better serve you. Please forward all correspondence at the address below:

Broan-NuTone LLC
Indoor Air Quality Mkt.
926 W. State St.,
Hartford, WI 53027

CAUTION

Your unit may be installed in a non heated area (e.g.: attic). In this case, your unit must run all the time if the outside temperature is too cold (32°F or below). A GSHH3K unit or a GSEH3K unit must be protected from freezing with an insulation blanket or a duct board insulated enclosure. See installation manual.

CAUTION

The GSVH1K, GSHH3K and GSEH3K units are not dehumidifiers. During cooling season, when high humidity weather occurs, it is preferable to momentarily stop the air exchange with the outside, until the period of excessive humidity passes. This will prevent too much humidity from entering the home. To stop the air exchange with a GSVH1K, set its wall controller to OFF. To stop the air exchange with a GSHH3K or a GSEH3K, set its wall controller to RECIRCULATION (the unit will continue to filter the inside air).

NOTE: The energy recovery ventilator GSEH3K is designed to assist in the management of humidity introduced into the home. In extreme humidity conditions, the use of additional dehumidification may be desirable. Quickly remove all excess moisture and keep areas clean.

TABLE OF CONTENTS

1.0	ABOUT THESE UNITS	4
2.0	CONTROLS.....	5-8
	2.1 <i>Main Switch</i>	5
	2.2 <i>Operating ACCGSC1 Controller</i>	5
	2.3 <i>Operating 40425 Controller</i>	6-8
3.0	MAINTENANCE.....	9-12
	3.1 <i>Semi-annual Maintenance</i>	9-11
	3.2 <i>Annual Maintenance</i>	11
	3.3 <i>Optional Alpine/pine Filter</i>	12
4.0	TROUBLESHOOTING	13
5.0	WARRANTY	14

1. ABOUT THESE UNITS

WARNING

TO REDUCE THE RISK OF FIRE, ELECTRIC SHOCK, OR INJURY TO PERSON(S) OBSERVE THE FOLLOWING:

1. This unit is intended for residential installation only.
2. Installation must be done in accordance with all applicable codes and standards, including fire-rated construction codes and standards.
3. This unit is not designed to provide combustion and/or dilution air for fuel-burning appliances.
4. Do not install in a cooking area or connect directly to an appliance.
5. Before replacing filters, servicing or cleaning unit, disconnect the power cord from the electrical outlet.
6. When cutting or drilling into the wall or ceiling, do not damage electrical wiring or other hidden utilities.
7. Do not use this unit with any solid-state speed control device other than wall controls ACCGSC1 or 40425, provided with the unit.
8. This unit must be grounded. The power supply cord has a 3-prong grounding plug for your personal safety. It must be plugged into a mating 3-prong grounding receptacle, grounded in accordance with the national electrical code and local codes and ordinances. Do not remove the ground prong. Do not use an extension cord.
9. This unit must be installed in a weatherized location out of direct sunlight and protected from the elements.
10. Use this unit only in the manner intended by the manufacturer. If you have questions, contact the manufacturer at the address or telephone number listed in this document.
11. When cleaning the unit, it is recommended to wear safety glasses and gloves.

CAUTION

1. For general ventilating use only. Do not use to exhaust hazardous or explosive materials and vapors.
2. Intended for residential installation in accordance with the requirements of NFPA 90B.
3. For GSVH1K, GSHH3K and GSEH3K units only: Be sure to duct air outside. Do not intake / exhaust air into spaces within walls or ceiling or into attics, crawl spaces, or garage.
4. Do not run any air ducts directly above or closer than 2 ft (0.61 m) to any furnace or its supply plenum, boiler, or other heat producing appliance. If a duct has to be connected to the furnace return plenum, it must be connected not closer than 2 ft (0.61 m) from this plenum connection to the furnace.
5. The ductwork is intended to be installed in compliance with all local and national codes that are applicable.
6. To avoid premature clogged filters, turn OFF the unit during construction or renovation.
7. At least once in a year, the unit mechanical and electronic parts should be inspected by qualified service personnel.
8. Please read the unit specification label on the product for further information and requirements.

2. CONTROLS

2.1 MAIN SWITCH

All units are equipped with a 3-position main switch, located on the front panel. The unit is intended for use with a wall controller (provided, see below). The main switch is to remain in either the "OFF" or "Normal/Remote" modes ONLY. The "Normal/Remote" mode allows the homeowner to operate the product from the wall controller (supplied with the unit), typically mounted near a thermostat or other convenient location.

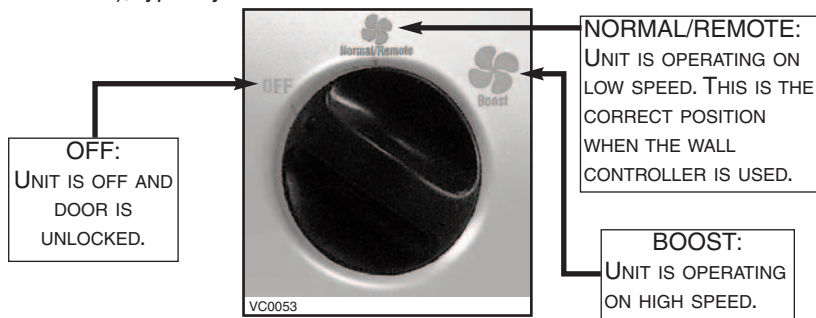

2.2 OPERATING ACCGSC1 CONTROLLER

2.2.1 ACCGSC1 CONTROLLER DESCRIPTION

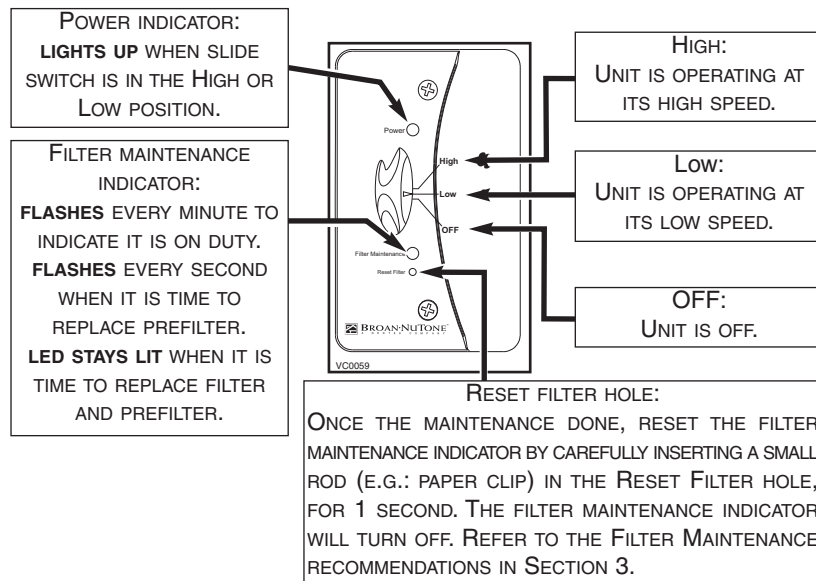

2.2.2 USING ACCGSC1 CONTROLLER

- **OFF:** To stop the unit, slide the button on this position.
- **Low:** For a day-to-day usage, slide the button on this position. The unit then will operate on low speed, providing 70 cfm.
- **High:** For a high speed operation, slide the button on this position. Generally used when more ventilation is required, such as parties, smokers, or for a 6-bedroom house. This mode provides 105 cfm.

2. CONTROLS (CONT'D)

2.3 OPERATING 40425 CONTROLLER

The included wall control 40425 is intended for GSHH3K and GSEH3K units only. The wall control is in OFF mode when power is applied for the first time. The mode does not change following a power failure.

2.3.1 40425 CONTROLLER DESCRIPTION

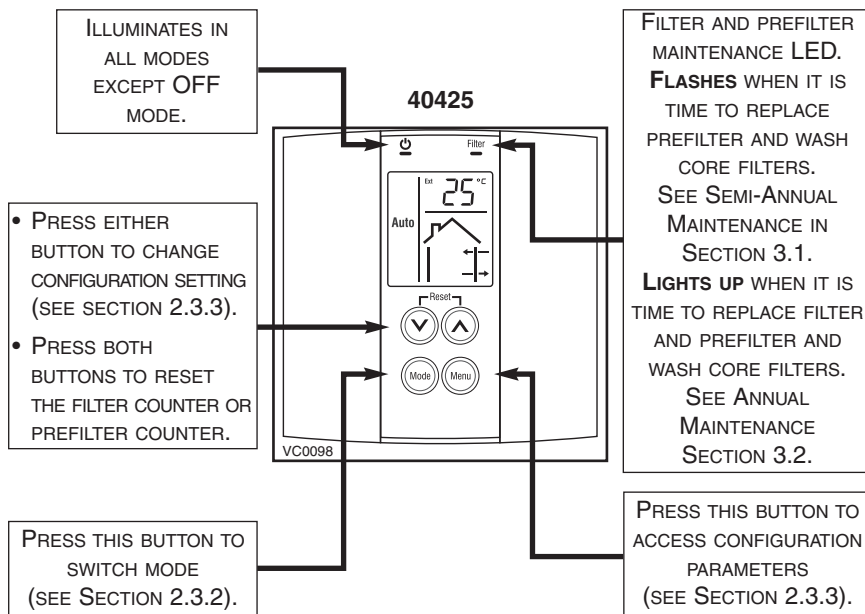

2.3.2 USING 40425 CONTROLLER

The wall controller 40425 provides 5 operation modes. Press the **Mode** button to select the desired mode.

NORMAL MODE (MIN)

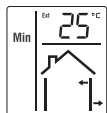

The unit exchanges air at normal speed. The outdoor temperature* is displayed.

BOOST MODE (MAX)

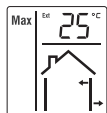

The unit exchanges air at high speed. The outdoor temperature* is displayed.

* The outdoor temperature reading is taken from the unit *FRESH AIR FROM OUTSIDE* port; due to the length of the insulated duct, the reading is slightly different from the real outside temperature.

2. CONTROLS (CONT'D)

2.3.2 USING 40425 CONTROLLER (CONT'D)

RECIRCULATION MODE (RE-CIRC)

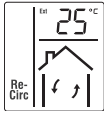

The unit recirculates air. However, every hour, the unit exchanges air for 6 minutes so that it can obtain a reading of the outdoor temperature*.

OFF MODE

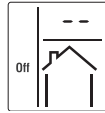

The unit is off. The outdoor temperature* is not displayed.

AUTOMATIC MODE (AUTO)

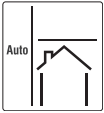

Off in Auto mode

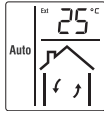

Air recirculation in Auto mode

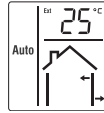

Air exchange in Auto mode

The unit operates on a 60-minute cycle. For the first 40 minutes, the unit recirculates air or is off (See configuration parameter 2 in Section 2.3.3). For the last 20 minutes, it exchanges air. However, if the outdoor temperature* is too high or too low (see configuration parameters 3 and 4 in Section 2.3.3), the unit recirculates air during the last 20 minutes.

* The outdoor temperature reading is taken from the unit *FRESH AIR FROM OUTSIDE* port; due to the length of the insulated duct, the reading is slightly different from the real outside temperature.

2. CONTROLS (CONT'D)

2.3.3 40425 WALL CONTROLLER CONFIGURATION

See the configuration table below for the list of configuration parameters.

Press the **Menu** button for 3 seconds to enter or exit the configuration menu.

NOTE: The wall control automatically saves any changes and exits the configuration menu if no button is pressed within the next 60 seconds.

Press the **Menu** button briefly to advance to the next parameter (menu number).

Press the ☺ or ☹ button to change the parameter setting.

CONFIGURATION TABLE

MENU NUMBER	PARAMETER	OPTIONS	DEFAULT SETTING	DESCRIPTION
1	TEMPERATURE FORMAT	°C / °F	°C	SELECTS BETWEEN °C AND °F DISPLAY.
2	AUTO MODE OPERATION	RE / OF	RE	SELECTS BETWEEN AIR RECIRCULATION (RE) AND OFF (OF). SEE SECTION 2.3.2.
3	AUTO MODE LOW TEMPERATURE LIMIT	-30°C TO 0°C (-22°F TO 32°F)	(-25°C) (-13°F)	PREVENTS AIR EXCHANGE IN AUTO MODE IF THE OUTDOOR TEMPERATURE IS TOO LOW. SEE SECTION 2.3.2.
4	AUTO MODE HIGH TEMPERATURE LIMIT	0°C TO 30°C (32°F TO 86°F)	(27°C) (81°F)	PREVENTS AIR EXCHANGE IN AUTO MODE IF THE OUTDOOR TEMPERATURE IS TOO HIGH. SEE SECTION 2.3.2.
5	BACKLIGHT MODE	AU / ON	AU	AU: THE SCREEN ILLUMINATES FOR 12 SECONDS WHEN ANY KEY IS PRESSED ON: THE SCREEN IS PERMANENTLY ILLUMINATED.

3. MAINTENANCE

⚠ WARNING

Risk of electrical shocks. Before performing any maintenance or servicing, always disconnect the unit from its power source.

3.1 SEMI-ANNUAL MAINTENANCE (ESSENTIAL)

Your wall controller (ACCGSC1 or 40425) tells you when to perform this maintenance when the **Filter Maintenance light is flashing**. Otherwise, maintenance should be performed every 6 months to ensure your unit proper operation for years to come. Follow these steps:

1. Turn switch knob to OFF to unlock the door.
2. Unlatch the door and open it. If required, the door can be removed. To do so, remove the stopper (A) located on the right side of the door hinge. Then, hold the door and hit with your palm its left side. Slide the door to the right to disengage it from the unit. Clean the inner side of the door with a clean damp cloth, then wipe with a dry one.

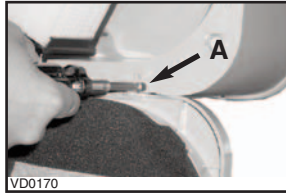

3. Slide out the air diffuser (model GSVH1K), the heat recovery core (model GSHH3K only), the energy recovery core (model GSEH3K only) and the filter cartridge from the unit.

NOTES: 1. **On model GSVH1K only, never grab the white shaft (item 2) to pull out the air diffuser.**

2. To remove the filter cartridge, pull on its tabs.

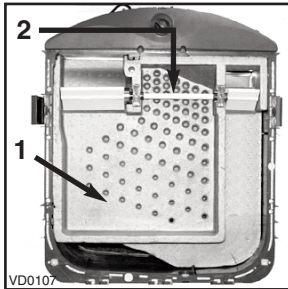

1) Air Diffuser
2) White shaft



3) Heat recovery core

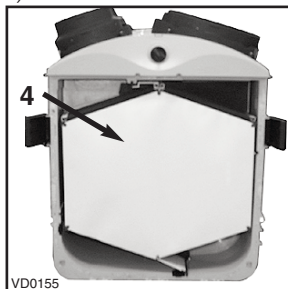

4) Energy recovery core

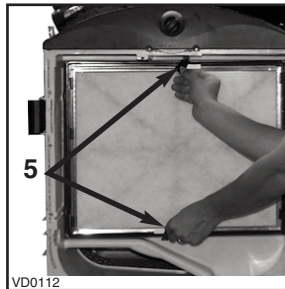

5) Filter cartridge tabs

3. MAINTENANCE (CONT'D)

3.1 SEMI-ANNUAL MAINTENANCE (ESSENTIAL) (CONT'D)

- Using your thumbs, push on the prefilter side to disengage it from the filter cartridge. Then, slide it out of the filter cartridge and discard it. Install the new prefilter by reversing this operation.

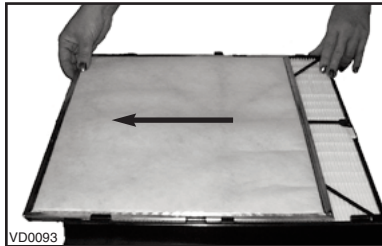
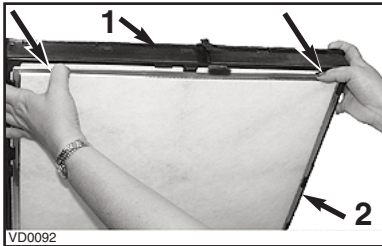

- Filter cartridge
- Prefilter

- Clean the inside walls of the unit with a clean damp cloth, then wipe with a dry one. Install the new filter cartridge.

6.1 For HEPA Filtration and Fresh Air Ventilation model GSVH1K only

Clean the air diffuser with a clean damp cloth, then wipe with a dry one. Once the air diffuser completely dry, slide it back into the unit.

6.2 For HEPA Filtration, Fresh Air and Heat Recovery model GSHH3K only

Slide out the two core filters (item 1) from the heat recovery core and wash them under hot water with mild soap.

Remove the dust on the heat recovery core (item 2) using a vacuum cleaner with a soft brush attachment. Rinse the core filters thoroughly and let dry before reinstalling them on the heat recovery core. Reinstall the heat recovery core in the unit.

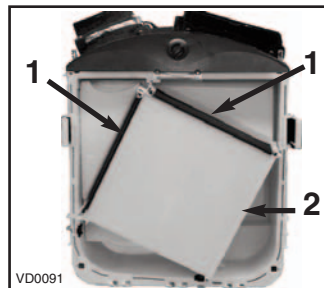

- Core filters
- Heat Recovery Core

NOTE: Make sure the damper spring (1) is still inside the left front port opening before reinstalling the heat recovery core.

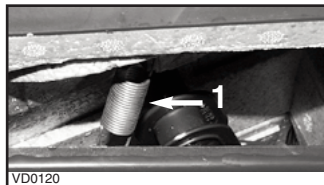

- Damper spring

3. MAINTENANCE (CONT'D)

3.1 SEMI-ANNUAL MAINTENANCE (ESSENTIAL) (CONT'D)

6.3 For HEPA Filtration, Fresh Air and Energy Recovery model GSEH3K only

CAUTION

The GSEH3K energy recovery core cannot be washed with water.

Slide out the two core filters (item 1) from the energy recovery core and wash them under hot water with mild soap.

Remove the dust on the energy recovery core (item 2) using a vacuum cleaner with a soft brush attachment.

Rinse the core filters thoroughly and let dry before reinstalling them on the energy recovery core.

Reinstall the energy recovery core in the unit.

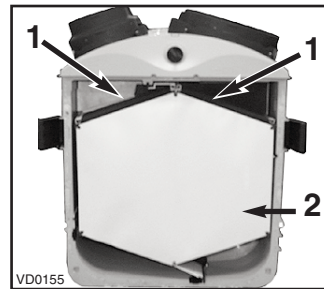

1) Core filters
2) Energy Recovery Core

NOTE: Make sure the damper spring (1) is still inside the left front port opening before reinstalling the energy recovery core.

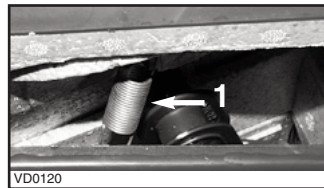

1) Damper spring

7. If removed, reinstall the door and its stopper. Close the latches and turn ON the switch knob to its previous position.
8. Your unit is equipped with a wall controller (ACCGSC1 or 40425). For ACCGSC1, reset the filter maintenance indicator by inserting a small rod (eg: paper clip end) into the reset filter hole of the wall control. Press lightly until the Filter Maintenance indicator light turns off. For 40425, to reset the counter and turn the LED OFF, simultaneously press both ⏴ and ⏵ buttons for 1 second.

3.2 ANNUAL MAINTENANCE (ESSENTIAL)

Your unit is equipped with a wall controller (ACCGSC1 or 40425), which tells when to perform maintenance when the **Filter Maintenance light stays ON**. Otherwise, this maintenance must be performed once a year to ensure your unit proper operation for years to come. Proceed as the Semi-annual Maintenance (Section 3.1), but instead of replacing the prefilter (point 4), discard the complete HEPA Filter cartridge (including prefilter). Install a new HEPA filter cartridge with a new prefilter on it.

NOTE : In annual maintenance, for 40425, to reset the counter and turn the LED OFF, simultaneously press both ⏴ and ⏵ buttons for 5 seconds.

3. MAINTENANCE (CONT'D)

3.3 OPTIONAL ALPINE/PINE FILTER

During pollen season, or as needed, remove the assembled hood from its backplate by removing its 2 retaining screws.

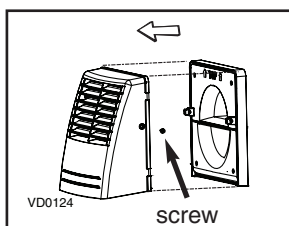

Then, slide out the optional Alpine/pine filter and clean it under water. Let dry before reinstalling it on the assembled hood. Reinstall the hood on its backplate.

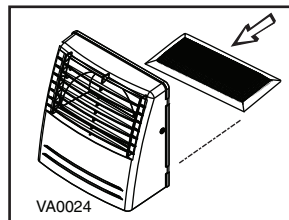

4. TROUBLESHOOTING

WARNING

Shock hazard. Never open the electronic box. No user-serviceable parts inside. There is a fuse on the electronic board. Never attempt to replace it. Refer servicing to qualified service personnel.

If the unit seems not working properly, call your installer or the nearest approved Service Center. You can also reach our Customer Service Departments or Technical Support listed below.

Broan-NuTone LLC

- Customer Service Department:
Telephone: 1-800-558-1711
Fax: 1-800-356-5862
- Technical Support:
Telephone: 1-800-637-1453
Fax: 1-262-673-8709

5. WARRANTY



WHOLE-HOUSE AIR FILTRATION SYSTEM

WARRANTY

Broan-NuTone warrants to the original consumer purchaser of its products, that such products will be free from defects for a period of two (2) years, from date of original purchase.

THERE ARE NO OTHER WARRANTIES, EXPRESS OR IMPLIED, INCLUDING, BUT NOT LIMITED TO, IMPLIED WARRANTIES OF MERCHANTABILITY OR FITNESS FOR A PARTICULAR PURPOSE. BROAN-NUTONE WILL NOT BE HELD RESPONSIBLE FOR ANY CLAIMS OVER THE ORIGINAL PURCHASE PRICE OF A **BROAN-NUTONE WHOLE-HOUSE AIR FILTRATION SYSTEM**, NOR HELD RESPONSIBLE FOR SUBSEQUENT DAMAGE OR INCIDENT.

During the period stated above, Broan-NuTone will, at its opinion, repair or replace, without charge, any product or part which is found to be defective under normal use and service. THIS WARRANTY DOES NOT EXTEND TO ANY FILTER, PREFILTER OR CORE FILTERS (IF APPLICABLE). This warranty does not cover **a)** normal maintenance and service, **b)** any products or parts which have been subject to misuse, negligence, accident, improper maintenance or repairs made by other than Broan-NuTone or **c)** a faulty installation or installation contrary to recommended installation instructions.

The duration of any implied warranty is limited to the 2-year period as specified for the express warranty. Some states do not allow limitation on how long an implied warranty lasts, so the above limitation may not apply to you.

BROAN-NUTONE'S OBLIGATION TO REPAIR OR REPLACE AT BROAN-NUTONE'S OPTION, SHALL BE THE PURCHASER'S SOLE AND EXCLUSIVE REMEDY UNDER THIS WARRANTY. BROAN-NUTONE SHALL NOT BE LIABLE FOR INCIDENTAL, CONSEQUENTIAL OR SPECIAL DAMAGES ARISING OUT OF OR IN CONNECTION WITH PRODUCT USE OR PERFORMANCE. SOME STATES DO NOT ALLOW THE EXCLUSION OR LIMITATION OF INCIDENTAL OR CONSEQUENTIAL DAMAGES, SO THE ABOVE LIMITATION OR EXCLUSION MAY NOT APPLY TO YOU.

This warranty gives you specific legal rights and you may also have other rights, which vary from state to state. This warranty supersedes all prior warranties.

In order to qualify for a warranty claim, the owner of a Broan-NuTone WHOLE-HOUSE AIR FILTRATION SYSTEM must have the model and serial number along with a proof of the original purchase date. In each case, costs for the removal of a defective part (and/or unit) and installation of a new or repaired one and travel costs are not covered by this warranty.

BROAN-NUTONE LLC, 926 W. S STATE ST, HARTFORD WI 53027 1-800-637-1453