

This Owner's Manual is provided and hosted by [Appliance Factory Parts](#).



BROAN 9810WH Owner's Manual

[Shop genuine replacement parts for BROAN 9810WH](#)



[Find Your BROAN HVAC Parts - Select From 1309 Models](#)

----- Manual continues below -----

Wall Heaters 9810WH, 9815WH SERIES

SAFETY INSTRUCTIONS

- Carefully read all instructions and product labels before beginning installation.
- Only mount the heater in a vertical position.
- **Mount the heater at least 6" above the finished floor.**
- Do not mount the heater over a bathtub or in a shower stall enclosure.
- **When mounted, the heater should not be closer than 12" to an adjacent wall.**
- Do not block the wall heater — i.e., by mounting under a towel rack, behind a door, etc.

ELECTRICAL SPECIFICATIONS

NOTE: See wiring label on heater housing. The heater may be wired for either 120V or 240V operation and requires a separate circuit.

UNIT DIMENSIONS

Housing: 12¹/₂" high x 10¹/₂" wide x 3³/₈" deep.

Grille: 14³/₄" high x 11" wide x 1" deep.

Wall Cutout: 12⁵/₈" high x 10⁵/₈" wide.

MOUNTING THE HOUSING

(New Construction)

Refer to Figure 1.

1. Choose heater location. **Make sure the heater will not be mounted closer than 12" from a vertical surface or 6" from the floor.**
2. Using nails or screws, mount one side of housing to wall stud. The flange must be flush to the stud.
3. Run wiring from circuit breaker or fuse box to heater location.
4. Install box connector into wiring entrance hole in housing's junction box.
5. Pull wiring through entrance hole and secure cable to box connector. Allow 6" of wiring to make connections.
6. Finished wall opening should be 12⁵/₈" high x 10⁵/₈" wide.

MOUNTING THE HOUSING

(Existing Construction)

1. Choose heater location. Make sure the heater will not be mounted closer than 12" from a vertical surface or 6" from the floor.
2. **Refer to Figure 2.** Make wall cutout next to a wall stud. Cutout size: 12⁵/₈" high x 10⁵/₈" wide with frame.)
3. Run wiring from circuit breaker or fuse box to heater location.
4. Install box connector into wiring entrance hole in housing's junction box.
5. Pull wiring through cutout and secure cable to box connector. Allow 6" of wiring to make connections.
6. **Refer to Figure 3.** Insert TOP of housing into cutout first so that box connector clears the wall. Then, insert bottom of housing into cutout. **The flange must be flush with the wall.**
7. Use nails or screws to mount one side of housing to wall stud.

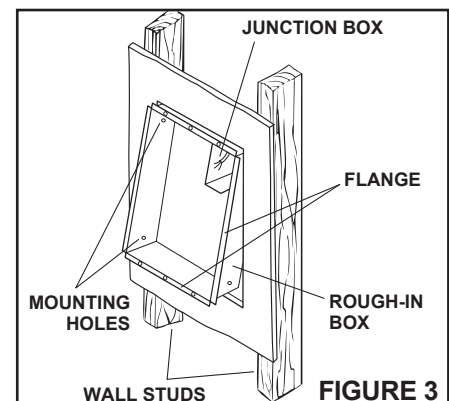
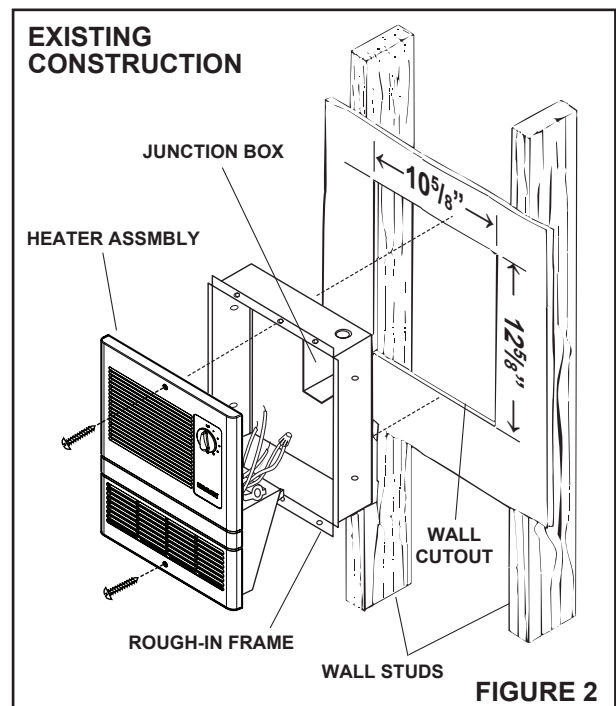
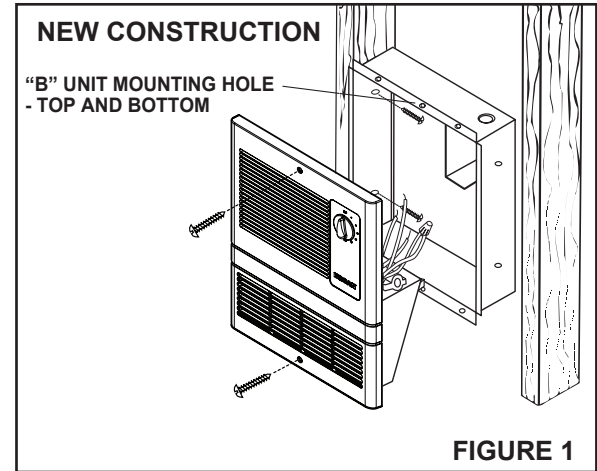

WIRING CONNECTIONS

All wiring must comply with local codes and unit must be properly grounded.

1. While making wiring connections, support the heater assembly on the bottom of the rough-in frame.
2. For 120 Volt operation, make wiring connections as shown in Figure 4.
3. For 240 Volt operation, make wiring connections as shown in Figure 5.
4. Use wire nuts to make connections. Insulate all connections with electrical tape.

SECURING THE HEATER

1. Dress all wiring back to into junction box.
2. Locate center holes in housing flange and align with mounting holes in grille.
3. Use two provided screws to attach grille to housing.

OPERATION

Turn thermostat fully clockwise to HIGH position. Allow heater to run until room is at desired temperature. Adjust thermostat as required to maintain desired temperature. Turn the thermostat to FULL COUNTERCLOCKWISE position when operation is no longer desired.

Thermal protector: If for any reason temperatures increase beyond normal limits, a safety thermal fuse will shut heater off. The heater will require servicing by a qualified electrician.

Check entire installation to determine cause of overheating.

SERVICE PARTS

Key No.	Part No.	Description
1	99111432	Grille
2	99360253	Knob
3	52872039	Grille Screw
4	44953000	Heater Assembly (9810WH)
	44954000	Heater Assembly (9815WH)
5	57271000	Thermostat, with Mounting Nut
6	33384000	Thermostat Cover
7	33178000	Blower & Motor
8	0936B000	Thermal Protector
9	61962000	Heat Box
10	35841000	Thermal Fuse (2 required)

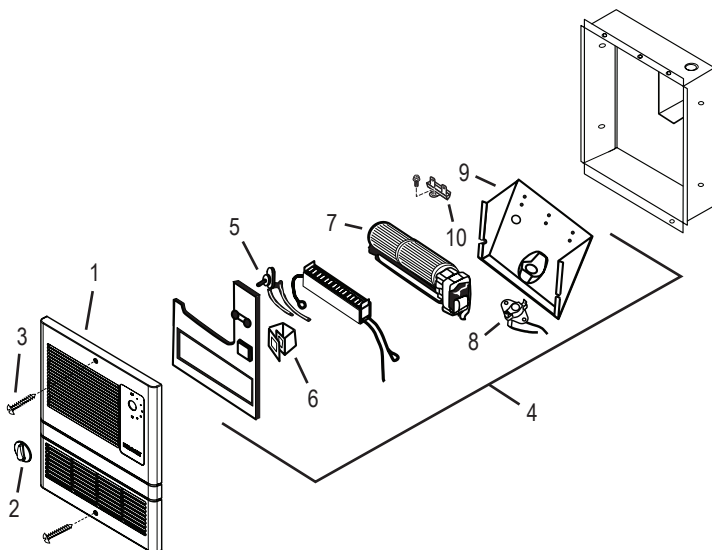

120vAC

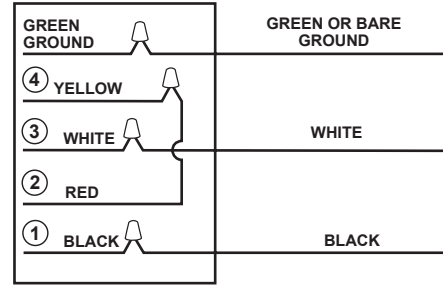

FIGURE 4

240vAC

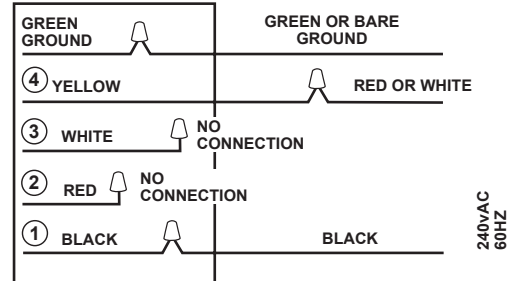

FIGURE 5

WARRANTY

BROAN-NUTONE ONE YEAR LIMITED WARRANTY

Broan-NuTone warrants to the original consumer purchaser of its products that such products will be free from defects in materials or workmanship for a period of one year from the date of original purchase. THERE ARE NO OTHER WARRANTIES, EXPRESS OR IMPLIED, INCLUDING, BUT NOT LIMITED TO, IMPLIED WARRANTIES OF MERCHANTABILITY OR FITNESS FOR A PARTICULAR PURPOSE.

During this one-year period, Broan-NuTone will, at its option, repair or replace, without charge, any product or part which is found to be defective under normal use and service.

THIS WARRANTY DOES NOT EXTEND TO FLUORESCENT LAMP STARTERS AND TUBES. This warranty does not cover (a) normal maintenance and service or (b) any products or parts which have been subject to misuse, negligence, accident, improper maintenance or repair (other than by Broan-NuTone), faulty installation or installation contrary to recommended installation instructions.

The duration of any implied warranty is limited to the one-year period as specified for the express warranty. Some states do not allow limitation on how long an implied warranty lasts, so the above limitation may not apply to you.

BROAN-NUTONE'S OBLIGATION TO REPAIR OR REPLACE, AT BROAN-NUTONE'S OPTION, SHALL BE THE PURCHASER'S SOLE AND EXCLUSIVE REMEDY UNDER THIS WARRANTY. BROAN-NUTONE SHALL NOT BE LIABLE FOR INCIDENTAL, CONSEQUENTIAL OR SPECIAL DAMAGES ARISING OUT OF OR IN CONNECTION WITH PRODUCT USE OR PERFORMANCE. Some states do not allow the exclusion or limitation of incidental or consequential damages, so the above limitation or exclusion may not apply to you.

This warranty gives you specific legal rights, and you may also have other rights, which vary from state to state. This warranty supersedes all prior warranties.

To qualify for warranty service, you must (a) notify Broan-NuTone at the address or telephone number below, (b) give the model number and part identification and (c) describe the nature of any defect in the product or part. At the time of requesting warranty service, you must present evidence of the original purchase date.

Broan-NuTone LLC Hartford, Wisconsin www.broan.com 800-558-1711