

This Owner's Manual is provided and hosted by [Appliance Factory Parts](#).

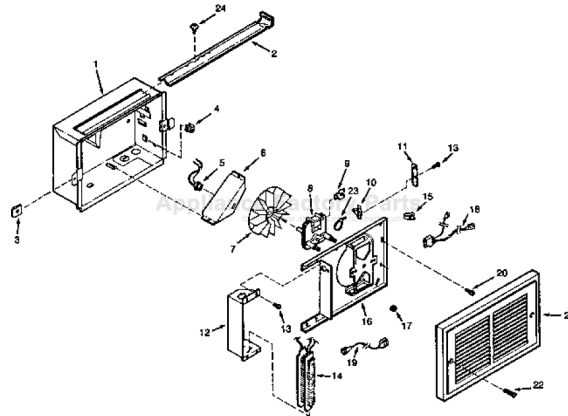

BROAN 124 Owner's Manual

[Shop genuine replacement parts for BROAN 124](#)



[Find Your BROAN HVAC Parts - Select From 1309 Models](#)

----- Manual continues below -----

REGISTER HEATERS

FOR IN-WALL RECESSED MOUNTING

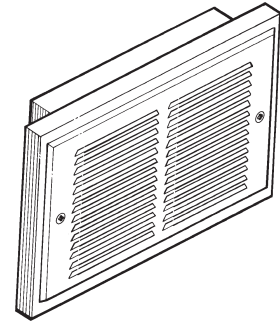

Don't give up beautiful woodwork for baseboard heating — Use these space-saving, downflow alternatives.

FEATURES:

GRILLE:

- Sturdy, one-piece construction
- 20 gauge, with downflow louvers
- White, baked enamel finish
- Color-coordinated mounting screws

HEATER ASSEMBLY:

- Nickel-chrome resistance alloy heating element
- Mica insulated, zig-zag element configuration
- 120 VAC units can be converted to operate on 240 VAC
- All models can be converted to operate at half-wattage
- Manual reset thermal overload protector
- Permanently lubricated motor
- High-efficiency blower wheel
- Removable from housing for cleaning or servicing

HOUSING:

- 24-gauge steel finished with black epoxy paint
- Removable wiring cover - connect wiring away from tight corners
- Mounts directly to wall studs
- Includes housing mask - to prevent construction damage to roughed-in heater

Model 171H: Rough-in housing for use with finish assemblies

ACCESSORIES: (purchase separately)

- Model 86W Line-Voltage Thermostat
- Model 59V, 59W 60-Minute Timer
- Model 61V, 61W 15-Minute Timer

NOTE: This heater is intended to be used to supply supplemental heat from a wall location in new or existing construction.

TYPICAL SPECIFICATION

Heater shall be Broan Model 120, (124), (128).

Unit shall have steel housing finished with black, epoxy paint. It will be recessed mounted in the wall.

Heater to deliver 1000 watts (Model 120), 1500 watts (Model 124), 2000 watts (Model 128) of fan-forced heat at safe "black" temperatures. It must be convertible to operate at half-wattage, 120 VAC units must be converted to operate at half-wattage. 120 VAC units must be convertible to operate on 240 VAC. Heater shall include a thermal overload protector with manual reset.

Grille will be White in color, of one-piece construction and will have downflow louvers. Color-coordinated grille screws to be provided.

Unit shall be controlled with a wall-mounted thermostat (Model 86W - Line Voltage Thermostat), or timer (Model 59V, 59W - 60-Minute Timer), (Model 61V, 61W - 15-Minute timer).

Heater shall be U.L. listed.



Broan-NuTone LLC, 926 West State Street, Hartford, Wisconsin 53027 (1-800-637-1453)

REFERENCE	QTY.	REMARKS	Project
			Location
			Architect
			Engineer
			Contractor
			Submitted by Date



PERFORMANCE RATINGS — REGISTER HEATERS

MODEL	WATTS	VOLTS	AMPS	BTU/HR.	PACKAGING	SHIPPING WT. (Lbs.)
120	1000 / 500 750 1000	120 208 240	8.3 / 4.1 3.61 4.16	3413 / 1707 2560 3413	Single	7.6
124	1500 / 750 1125 1500	120 208 240	12.5 / 6.2 5.41 6.25	5120 / 2560 3840 5120	Single	7.6
128	2000 / 1000 1500 / 750	240 208	8.3 / 4.1 7.2 / 3.6	6826 / 3413 5120 / 2560	Single	7.6
171H	—	—	—	—	4-Pack Rough-in Housing Only	11.9 4-Pack

Bold ratings are factory-wired.

