

This Owner's Manual is provided and hosted by [Appliance Factory Parts](#).



SUNBEAM 4215 Owner's Manual

[Shop genuine replacement parts for SUNBEAM 4215](#)



[Find Your SUNBEAM Small Appliance Parts - Select From 72 Models](#)

----- Manual continues below -----

Sunbeam®

Instruction Manual **Steam Master® Irons**

Manual de Instrucciones **Planchas Steam Master®**

MODELS/ 4211, 4212, 4213, 4214,
MODELOS 4215, 4216, 4219, 4220



www.sunbeam.com

P.N. 113165-004

IMPORTANT SAFEGUARDS

When using electrical appliances, basic safety precautions should always be followed including the following:

READ ALL INSTRUCTIONS BEFORE USE

- Use iron only for its intended use.
- To protect against risk of electric shock, do not immerse the iron in water or other liquids.
- The fabric select dial and steam lever should always be turned to “O/Off” before plugging or unplugging from outlet. Never yank cord to disconnect from outlet; instead, grasp plug and pull to disconnect.
- Do not allow cord to touch hot surfaces. Let iron cool completely before putting away. Loop cord loosely around iron when storing.
- Always disconnect iron from electrical outlet when filling with water or emptying and when not in use.
- Do not operate iron with a damaged cord or if the iron has been dropped or damaged. To avoid the risk of electric shock, do not disassemble the iron. Take it to an authorized service center for examination and/or repair. Incorrect reassembly can cause a risk of electric shock when the iron is used.
- Close supervision is necessary for any appliance being used by or near children. Do not leave iron unattended while plugged in or turned on or on an ironing board.
- Burns can occur from touching hot metal parts, hot water or steam. Use caution when you turn a steam iron upside down – there may be hot water in the reservoir.
- If the iron is not operating normally, disconnect from the power supply and have the iron serviced by an authorized service center. Or call Customer Service at 800-458-8407.
- Your SUNBEAM® iron is designed to rest on the heel rest. Do not leave the iron unattended. Do not set the iron on an unprotected surface, even if it is on its heel rest.

SPECIAL INSTRUCTIONS

- This is a 1200-Watt appliance. To avoid a circuit overload, do not operate another high wattage appliance on the same circuit.
- If an extension cord is absolutely necessary, a 15-ampere cord should be used. Cords rated for less amperage may overheat. Care should be taken to arrange the extension cord so that it cannot be pulled or tripped over.

FOR PRODUCTS PURCHASED IN THE UNITED STATES AND CANADA

To reduce the risk of electrical shock, this appliance has a polarized plug (one blade is wider than the other). This plug fits a polarized outlet only one way; if the plug does not fit fully into the outlet, reverse the plug. If it still does not fit, contact a qualified electrician. Do not attempt to defeat this safety feature.

SAVE THESE INSTRUCTIONS

IRONING GUIDE

FABRIC	SUGGESTED STEAM SETTING	FABRIC SELECT DIAL SETTING	IRONING RECOMMENDATIONS
Acrylic	○/Off (Dry)	Synthetic	Iron garment inside out
Acetate	○/Off (Dry)	Synthetic	Iron garment inside out while still damp.
Polyester	○/Off (Dry)	Synthetic	Iron garment inside out while still damp.
Rayon	○/Off (Dry)	Synthetic	Iron garment inside out.
Silk	○/Off (Dry)	Silk	Iron garment inside out. Use an ironing cloth* to prevent shine marks.
Viscose	○/Off (Dry)	Silk	Mainly dry iron; steam may be used under garment manufacturer's instructions.
Nylon	○/Off (Dry)	Silk	Iron garment inside out while still damp.
Wool	Steam	Wool	Iron garment inside out or use an ironing cloth.*
Wool Blends	Steam	Wool	Iron garment inside out or use an ironing cloth.*
Cotton Blends	Steam	Cotton	Follow garment manufacturer's instructions. Use setting for the fiber requiring the lowest setting.
Corduroy	Steam	Cotton	Iron garment inside out or use an ironing cloth* and then brush the garment with your hand to raise the texture of the fabric.
Cotton	Steam	Cotton	Iron dark fabrics inside out to prevent shine marks.
Linen	Steam	Linen	Iron garment inside out or use an ironing cloth* to prevent shine marks (especially on dark fabrics).
Denim	Steam	Linen	Use the SPRAY MIST® feature and/or the SHOT OF STEAM® for deeper penetration to remove wrinkles.

*An ironing cloth is a cotton, dry-cleaned cloth that you place over the garment you are ironing to prevent the fabric from looking shiny.

Note: Some fabrics may require more steam than others. Your iron has the capability to adjust steam as needed.

FEATURES OF YOUR STEAM MASTER® IRON

1. SPRAY MIST® Release
2. Covered Water Fill Hole
3. Fabric Select Dial
4. Steam / Self-Clean Lever
5. SPRAY MIST® Button
6. SHOT OF STEAM® / Vertical Steam Button
(select models only)
7. Power Indicator Light / MOTION SMART®
Auto-Off Indicator
8. Soft Grip Handle
9. 360° Tangle-Free Swivel Cord
(select models only)
10. Retractable Cord *(select models only)*
11. Anti-Calcium System *(select models only)* –
Inside Water Reservoir
12. See-Through Water Reservoir
13. Soleplate

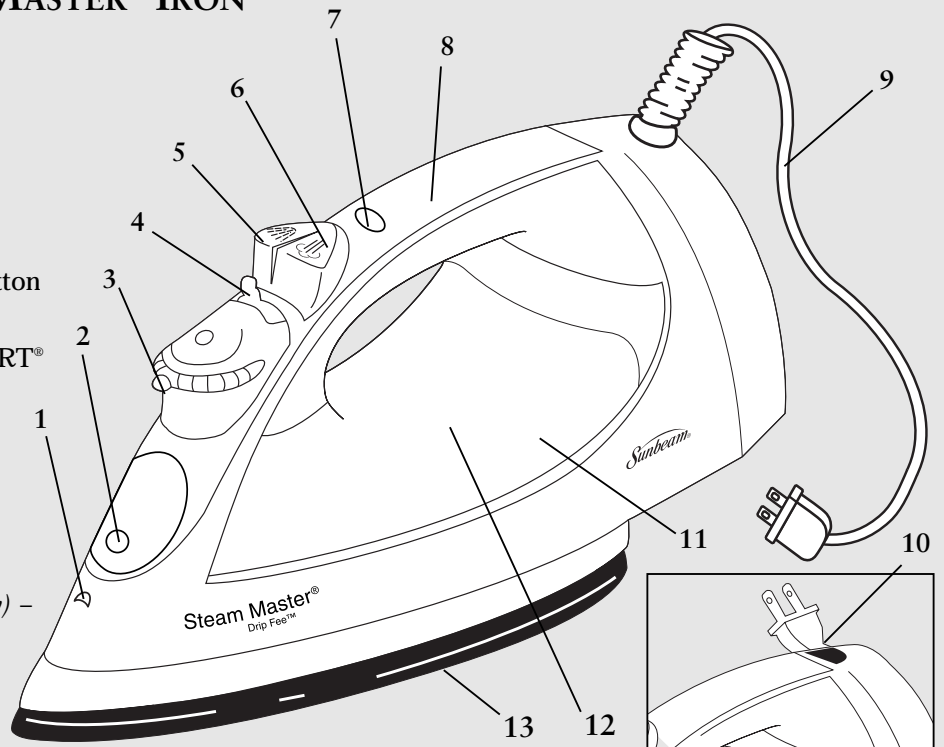

IRONING TIPS

- Always read garment labels and follow the manufacturer's ironing instructions.
- Sort the articles to be ironed according to the type of fabric.
- You should first iron garments requiring low temperature (*e.g., silks and synthetics*) to avoid damaging them with an iron that is too hot.
- If you are unsure of the fabric content of the garment, test a small area, such as a seam or facing, before ironing a visible area. Start with a low temperature and gradually increase the heat to find the best setting.
- When changing the temperature from a high setting to a low setting, allow approximately 5 minutes for the lower temperature to be reached.
- When steam ironing, use long, slow passes over the fabric. This will allow the steam to penetrate the fabric while allowing the heat of the soleplate to dry out the moisture.
- To iron linens, turn garment inside out. Be careful not to use an iron that is too hot because the lining may melt or stick to the soleplate.
- To iron zippers, use an ironing cloth or make sure the zipper is closed and iron over the flap. Never iron directly over an unprotected zipper.
- Use the Ironing Guide to select the best setting and method for the fabric you plan to iron.

TO FILL THE WATER RESERVOIR

1. Make sure the iron is unplugged. Set the Steam Lever to **○/Off (Dry)** and the Fabric Select Dial to **OFF**.
2. Lift the Water Fill Hole Cover.
3. Fill water cup with water. Pour water into iron water reservoir. Do not fill water reservoir beyond maximum fill level.

WARNING: To prevent the risk of burns, be careful when filling a hot iron with water. Hot metal parts, hot water and steam can cause injuries.

DRY IRONING

1. Make sure the Steam Lever is turned to the **○/Off (Dry)** setting.
2. Plug the cord into a 120-Volt AC outlet.
3. Turn the large Fabric Select Dial to the fabric setting you desire (Silk or Synthetics).
Allow the iron to heat for 2 minutes. While the iron is heating, make sure it is sitting on its heel rest on a stable, protected surface.

NOTE: While the Steam Lever is turned to the **○/Off (Dry)** setting, you may still use the **SHOT OF STEAM®** or **SPRAY MIST®** feature. Please make sure the water reservoir is 1/4 full of water.

TIP: Refer to the Ironing Guide for the recommended setting for your fabric.

STEAM IRONING

1. Follow the instructions for “Filling the Water Reservoir”.
2. Plug the cord into a 120-Volt AC outlet.
3. Turn the large Fabric Select Dial to the fabric setting you desire (*Synthetic, Silk, Linen, Cotton or Wool*). Allow the iron to heat for 2 minutes. While the iron is heating, make sure it is sitting on its heel rest on a stable, protected surface.
4. Allow the iron to heat for 2 minutes, and then turn the Steam lever to the appropriate setting.

TIP: Refer to the Ironing Guide for the recommended setting for your fabric.

IMPORTANT: When not ironing, always set the Steam Lever to **○/Off (Dry)** and the Fabric Select Dial to **OFF**.

USING THE IRON'S SPECIAL FEATURES

SPRAY MIST® FEATURE

The SPRAY MIST® feature is a powerful water spray mist that dampens the fabric to aid in removing wrinkles from heavy fabrics and for setting creases.

To use the SPRAY MIST® Feature:

Press the SPRAY MIST® button firmly.

SHOT OF STEAM® FEATURE

The SHOT OF STEAM® feature provides an extra burst of steam for deep penetration of stubborn wrinkles. You can use this feature while Dry or Steam ironing, but the water reservoir must be at least 1/4 full of water.

To use the SHOT OF STEAM® Feature:

Place the iron on top of the wrinkle and press the SHOT OF STEAM® button each time you would like an extra burst of steam. The SHOT OF STEAM® feature may be used continuously with just a short pause between shots.

VERTICAL STEAM *(select models only)*

The vertical steam feature allows your iron to function as a garment steamer.

TIP: When using the vertical steam on clothing, hang the clothing on a clothes hanger for best results. Hanging curtains and drapes may also be steamed.

To use Vertical Steam:

1. Make sure that the iron has heated up (2 minutes).
2. Hold the iron in a vertical position, with the iron close to but not touching the fabric you want to steam.
3. With your other hand, pull the fabric tight.
4. Press the SHOT OF STEAM® button for approximately 3-second intervals as you move the iron across the wrinkled area.

WARNING: To prevent the risk of burns, keep your hand away from the area being steamed.

WARNING: DO NOT steam garments while wearing them; this may result in injuries.

PATENTED MOTION SMART® AUTO-OFF FEATURE

When the iron is plugged in, the Power Indicator will light steadily, indicating that there is power to the iron.

If you leave the iron:

- in a horizontal position without moving it, or accidentally tip the iron over, it will automatically stop heating after 30 seconds. The Power Indicator will blink to let you know that the iron has stopped heating.
- in a vertical position (on its heel rest) without moving it, the iron will automatically turn off after 15 minutes. The Power Indicator will blink to let you know that the iron has stopped heating.

IMPORTANT: The Power Indicator will continue to blink until the iron is unplugged or reset.

To reset the iron:

Move the iron back and forth and allow it to reheat for 2 minutes. The indicator will stop blinking and the iron will start heating again.

WARNING: The patented MOTION SMART® Auto-Off is a safety feature, not a recommended means for turning your iron off. See “Caring for Your Iron After Use” for information on turning off your iron and storing it safely between use.

ANTI-CALCIUM SYSTEM *(select models only)*

The Anti-Calcium System is a permanent system located inside the water reservoir. This system removes calcium from the water and reduces calcium build-up on the soleplate.

RETRACTABLE CORD SECTION *(select models only)*

1. When winding the cord, hold the plug with one hand, and press the winding button with the other hand. *(Failure to hold plug may cause plug to fly.)*
2. The cord reel is compact for multi-layer winding of the cord. In case cord is not fully rewound, pull out the cord and steer cord evenly on the reel.
3. In case the cord is not pulled out easily, pull cord firmly.
4. Select the amount of cord desired before plugging into an electrical outlet.
5. Do not allow children to use retractable cord feature as the cord may cause injury.

CARING FOR YOUR IRON AFTER USE

TURNING OFF YOUR IRON

1. Turn the Steam Lever to **○/Off (Dry)** and Fabric Select Dial to Off.
2. Unplug the iron from the power source.

WARNING: NEVER yank the power cord when unplugging the iron. This can damage the cord.

STORING YOUR IRON

1. Allow the iron to cool.
2. If you do not use your iron on a daily basis, empty the water reservoir after each use for a longer iron life. To do so, unplug the iron, turn the iron upside down, open the fill hole cover, and allow water to flow from the fill hole. Shake the iron gently to remove trapped water drops.
3. On corded models only: Loosely loop the power cord around the heel rest and store the the iron on its heel rest.

IMPORTANT: Wrapping the cord around the iron too tightly can damage the cord.

TIP: When not ironing, always set the Steam Lever to **○/Off (Dry)** and the Fabric Select Dial to Off.

MAINTAINING YOUR STEAM MASTER® IRON

CLEANING THE SOLEPLATE

Clean the soleplate if starch or other residue accumulate.

To clean the Soleplate:

1. Allow the iron to cool and then wipe it with a soft, damp cloth.

WARNING: DO NOT use abrasive cleansers, scouring pads or vinegar to clean the soleplate. This will damage the finish.

2. Run the iron over an all-cotton cloth to remove any residue.

USING THE SELF-CLEANING FEATURE

You should use the Self-Cleaning feature once a month to maintain the optimal performance of your iron.

To use the Self-Cleaning feature:

1. Move the Steam Lever back and forth from **O/Off (Dry)** several times to remove debris and minerals from the Steam Valve. This keeps water flowing into the steam chamber.

MAINTENANCE

CLEANING THE ANTI-CALCIUM SYSTEM *(select models only)*

The STEAM MASTER® iron houses an anti-calcium filter in the reservoir, which eliminates impurities from the water.

To prolong the efficiency of this filter:

1. Unplug the iron and allow it to cool.
2. Locate the water cup that accompanied the iron. Fill it with water to the Sunbeam logo in the top right corner. Add 1 teaspoon of salt to the water and fill the water reservoir with this solution.
3. Leave the solution in the water reservoir for 15 minutes, then empty it.
4. Fill the water reservoir a second time with the salt water solution and empty it again after 15 minutes.
5. Fill the tank with fresh water to rinse and empty.

The Anti-Calcium System should be cleaned approximately once a month.

1 Year Limited Warranty

Sunbeam Products, Inc, or if in Canada, Sunbeam Corporation (Canada) Limited (collectively "Sunbeam") warrants that for a period of one year from the date of purchase, this product will be free from defects in material and workmanship. Sunbeam, at its option, will repair or replace this product or any component of the product found to be defective during the warranty period. Replacement will be made with a new or remanufactured product or component. If the product is no longer available, replacement may be made with a similar product of equal or greater value. This is your exclusive warranty.

This warranty is valid for the original retail purchaser from the date of initial retail purchase and is not transferable. Keep the original sales receipt. Proof of purchase is required to obtain warranty performance. Sunbeam® dealers, service centers, or retail stores selling Sunbeam® products do not have the right to alter, modify or any way change the terms and conditions of this warranty.

This warranty does not cover normal wear of parts or damage resulting from any of the following: negligent use or misuse of the product, use on improper voltage or current, use contrary to the operating instructions, disassembly, repair or alteration by anyone other than Sunbeam or an authorized Sunbeam® service center. Further, the warranty does not cover: Acts of God, such as fire, flood, hurricanes and tornadoes.

What are the limits on Sunbeam's Liability?

Sunbeam shall not be liable for any incidental or consequential damages caused by the breach of any express, implied or statutory warranty or condition.

Except to the extent prohibited by applicable law, any implied warranty or condition of merchantability or fitness for a particular purpose is limited in duration to the duration of the above warranty.

Sunbeam disclaims all other warranties, conditions or representations, express, implied, statutory or otherwise.

Sunbeam shall not be liable for any damages of any kind resulting from the purchase, use or misuse of, or inability to use the product including incidental, special, consequential or similar damages or loss of profits, or for any breach of contract, fundamental or otherwise, or for any claim brought against purchaser by any other party.

Some provinces, states or jurisdictions do not allow the exclusion or limitation of incidental or consequential damages or limitations on how long an implied warranty lasts, so the above limitations or exclusion may not apply to you.

This warranty gives you specific legal rights, and you may also have other rights that vary from province to province, state to state or jurisdiction to jurisdiction.

How To Obtain Warranty Service

In the U.S.A.

If you have any question regarding this warranty or would like to obtain warranty service, please call 1 800-458-8407 and a convenient service center address will be provided to you.

In Canada

If you have any question regarding this warranty or would like to obtain warranty service, please call 1 800-667-8623 and a convenient service center address will be provided to you.

In the U.S.A., this warranty is offered by Sunbeam Products, Inc located in Boca Raton, Florida 33431. In Canada, this warranty is offered by Sunbeam Corporation (Canada) Limited, located at 5975 Falbourn Street, Mississauga, Ontario L5R 3V8.

PLEASE DO NOT RETURN THIS PRODUCT TO ANY OF THESE ADDRESSES OR TO THE PLACE OF PURCHASE.