

This Owner's Manual is provided and hosted by [Appliance Factory Parts](#).



# LG LSC27910ST Owner's Manual

[Shop genuine replacement parts for LG LSC27910ST](#)



[Find Your LG Refrigerator Parts - Select From 834 Models](#)

----- Manual continues below -----



website: <http://us.lge.com>

**☎ 1-800-243-0000**

24 HOURS A DAY, 7 DAYS A WEEK FOR LG CUSTOMER SERVICE  
para el servicio LG (Atención al Cliente) 24 horas al día, 7 días a la semana

**LSC27910\*\***

## **SXS** REFRIGERATOR

### Owner's Manual

Please read this guide thoroughly  
before operating and keep it handy for  
reference at all times.

## REFRIGERADOR **SXS**

### Manual de Usuario

Lea detenidamente estas instrucciones  
antes utilizar el refrigerador y guárdelas  
como referencia para el futuro.

# Table of Contents

<b>Introduction</b>	Entry	3
	Important Safety Instruction	3
	Identification of Parts	6
<b>Installation</b>	Where to Install	6
	Door Removal	8
	Door Replacement	9
	Water Pipe Installation	9
	Water Connection Instruction Guide	9
	Operation Instruction Guide	10
	Height Adjustment	12
<b>Operation</b>	Starting	13
	Adjusting the Temperatures and functions (Dispenser/Automatic Icemaker)	13
	Shelf	17
<b>Suggestion on Food Storage</b>	Location of Foods	18
	Storing Foods	19
<b>Care and Maintenance</b>	How to Dismantle Parts	20
	General Information	22
	Cleaning	22
	Troubleshooting	23

# Entry

The model and serial numbers are found on the inner case or back of refrigerator compartment of this unit. These numbers are unique to this unit and not available to others. You should record requested information here and retain this guide as a permanent record of your purchase. Staple your receipt here.

Date of purchase: \_\_\_\_\_

Dealer: \_\_\_\_\_

Dealer address: \_\_\_\_\_

Dealer phone no.: \_\_\_\_\_

Model no.: \_\_\_\_\_

Serial no.: \_\_\_\_\_

## Important safety Instructions

### SAFETY MESSAGES

This guide contains many important safety messages. Always **read and obey**



This is the safety alert symbol. It alerts you to safety messages that inform you of hazards that can kill or hurt you or others, or cause damage to the product.

All safety messages will be preceded by the safety alert symbol and the hazard signal word DANGER, WARNING, or CAUTION. These words mean:



**DANGER** You will be killed or seriously injured if you don't follow instructions.



**WARNING** You can be killed or seriously injured if you don't follow instructions.



**CAUTION** Indicates an imminently hazardous situation which, if not avoided, may result in minor or moderate injury, or product damage only.

All safety messages will identify the hazard, tell you how to reduce the chance of injury and tell you what can happen if the instructions are not followed.

## WARNING

**To reduce the risk of fire, electric shock or injury to persons when using your product, basic safety precautions should be followed, including the following. Read all instructions before using this appliance:**

- NEVER unplug your refrigerator by pulling on the power cord. Always grip the plug firmly and pull it straight out from the outlet.
- Repair or replace immediately all electric service cords that have become frayed or otherwise damaged. Do not use a cord that shows cracks or abrasion damage along its length or at either the plug or connector end.
- When moving your refrigerator away from the wall, be careful not to roll over or damage it in any way.
- Do not crush or damage the water line.
- Do not store or use gasoline or other flammable vapors and liquids in the vicinity of this or any other appliance.
- Do not allow children to climb, stand, or hang on the refrigerator doors or shelves in refrigerator. They could damage the refrigerator and seriously injure themselves.
- Keep fingers out of "pinch point" areas; clearances between the doors and cabinet are necessarily small. Be careful when you open the doors when children are in the area.
- Unplug your refrigerator before cleaning or making any repairs.

3

**NOTE:** We strongly recommend that any servicing be performed by a qualified individual.

- Before replacing a burned-out light bulb, unplug the refrigerator or turn off power at the circuit breaker or fuse box in order to avoid contact with a live wire filament. (A burned-out light bulb may break when being replaced). NOTE: Setting either or both controls to the OFF position does not remove power to the light circuit.
- Do not store bottles in the freezer compartment they may break when frozen, causing damage.
- The refrigerator-freezer should be so positioned that the supply plug is accessible for quick disconnection when accident happens.
- For personal safety, this appliance must be properly grounded. Have the wall outlet and the circuit checked by a qualified electrician to make sure the outlet is properly grounded.
- This refrigerator must be properly installed in accordance with the Attention Installer Instructions that were taped to the front of the refrigerator.
- After your refrigerator is in operation, do not touch the cold surfaces in the freezer compartment when hands are damp or wet. Skin may adhere to the extremely cold surfaces.
- In refrigerators with automatic icemakers, avoid contact with the moving parts of the ejector mechanism, or with the heating element that releases the cubes. DO NOT place fingers or hands on the automatic icemaking mechanism while the refrigerator is plugged in.
- DO NOT refreeze frozen foods which have thawed completely. The United States Department of Agriculture in Home and Garden Bulletin No. 69 says:  
 "...You may safely refreeze frozen foods that have thawed if they still contain ice crystals or if they are still cold below 40° (4°C)."  
 "...Thawed ground meats, poultry, or fish that have any off-odor or off-color should not be frozen and should not be eaten. Thawed ice cream should be discarded. If the odor or color of any food is poor or questionable, get rid of it. The food may be dangerous to eat."  
 "Even partial thawing and refreezing reduces the eating quality of foods, particularly fruits, vegetables and prepared foods.  
 The eating quality of red meats is affected less than that of many other foods. Use refrozen foods as soon as possible to save as much of their quality as you can."

## DANGER

### Risk of child entrapment

Child entrapment and suffocation are not problems of the past. Junked or abandoned refrigerators are still dangerous... even if they will sit for "just a few days". If you are getting rid of your old refrigerator, please follow the instructions at right to help prevent accidents.

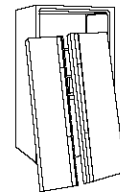

#### BEFORE YOU THROW AWAY YOUR OLD REFRIGERATOR OR FREEZER

- Take off the doors.
- Leave the shelves in place so that children may not easily climb inside.

## CFC DISPOSAL

Your old refrigerator may have a cooling system that used CFCs (chlorofluorocarbons). CFCs are believed to harm stratospheric ozone. If you are throwing away your old refrigerator, make sure the CFC refrigerant is removed for proper disposal by a qualified servicer. If you intentionally release this CFC refrigerant, you can be subject to fines and imprisonment under provisions of environmental legislation. This appliance contains fluid (refrigerant, lubricant), is made of parts and materials which are reusable and / or recyclable. All the important materials should be sent to the collection center of waste material and can be reused after rework (recycling). For take back, please contact with the local agency.

**GROUNDING  
REQUIREMENTS**

**⚠ WARNING**  
**Electrical**  
**Shock Hazard**

**IMPORTANT:** Please read carefully  
**TO CONNECT ELECTRICITY**

**FOR PERSONAL SAFETY,** this appliance must be properly grounded. Have the wall outlet and the circuit checked by a qualified electrician to make sure the outlet is properly grounded.

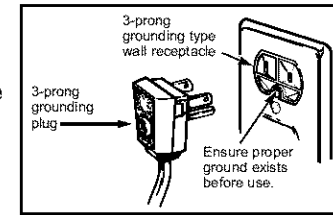
**RECOMMENDED GROUNDING METHOD**

The refrigerator should always be plugged into its own individual properly grounded electrical outlet rated for 115 Volts, 60 Hz, AC only and fused at 15 or 20 amperes. This provides the best performance and also prevents overloading house wiring circuits which could cause a fire hazard from overheated wires. It is recommended that a separate circuit serving only this appliance be provided. Use a receptacle which cannot be turned off with a switch or pull chain. Do not use an extension cord.

Where a standard two-prong wall outlet is encountered, it is your personal responsibility and obligation to have it replaced with a properly grounded three-prong wall outlet.

Do not, under any circumstances, cut or remove the third (ground) prong from the power cord.

**NOTE:** Before performing any type of installation, cleaning, or removing a light bulb, turn the control (Thermostat, Refrigerator Control or Freezer Control, depending on the model) to OFF and then disconnect the refrigerator from the electrical source. When you are finished, reconnect the refrigerator to the electrical source and reset the control (Thermostat, Refrigerator Control or Freezer Control, depending on the model) to the desired setting.

**USE OF EXTENSION CORDS**

Because of potential safety hazards under certain conditions, we strongly recommend against the use of an extension cord. However, if you still elect to use an extension cord, it is absolutely necessary that it be a UL-listed (in the United States), 3-wire grounding type appliance extension cord having a grounded type plug and outlet, and that the electrical rating of the cord be 15 amperes (minimum) and 120 volts.

Use of an extension cord will increase the clearance needed for the back of the refrigerator.

If the supply cord is damaged, it must be replaced by the manufacturer or its service agent or a similarly qualified person in order to avoid any hazard.

## Identification of Parts

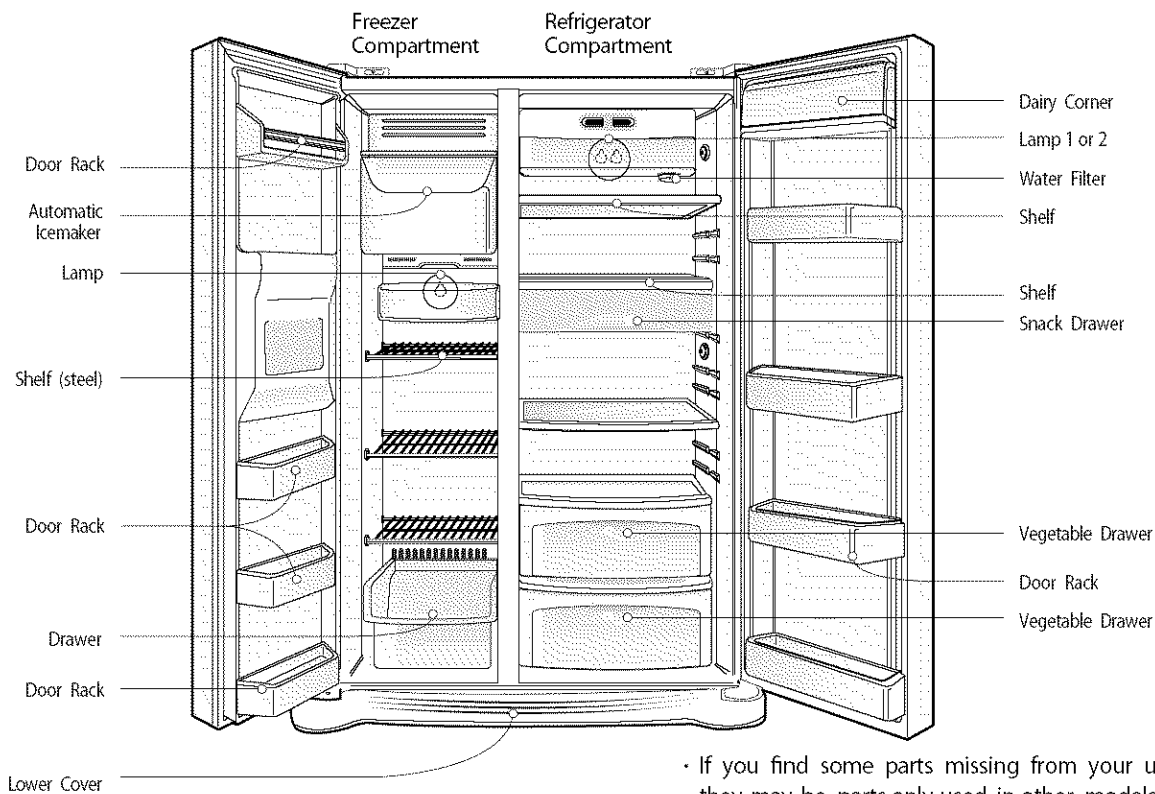

• If you find some parts missing from your unit, they may be parts only used in other models.

## Where to install

### Strong and even floor

Unstable installation may cause vibration and noise. If the floor to install the refrigerator on is not even, make the refrigerator level by rotating the height adjusting screw. Carpet or floor covering on which a refrigerator is installed may be discolored by heat from the bottom of the refrigerator.

If our refrigerator causes this kind of damage, there is something wrong with it. Customers will not stand for this.

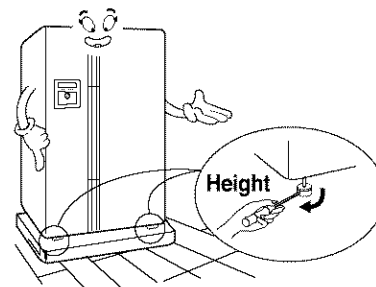

### A proper distance from adjacent items

Please keep the refrigerator at a proper distance from other things. Too small a distance from adjacent items may result in lowered freezing capability and increased electricity consumption charges.

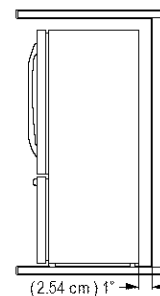

Where water supply can be easily connected in a dry place

Select a place where a water supply can be easily connected between the automatic ice maker and dispenser.  
Installing the refrigerator in a wet or damp area may cause rust and may be an electrical hazard.

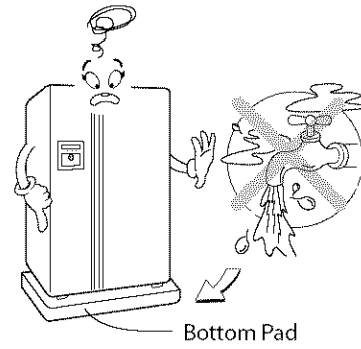

Where it is free from heat

If this refrigerator is installed where the ambient temperature is high, the freezing capacity is deteriorated and the cost of electricity used increases.

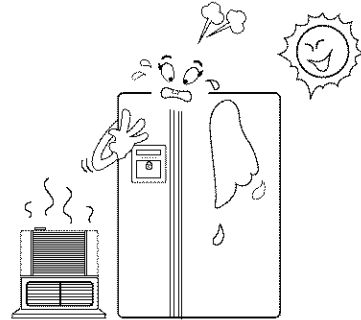

**NOTE**

- Install the refrigerator at a place where the ambient temperature is 5°C ~ 43°C (41°F ~ 110°F). Ambient temperature outside this range may cause product malfunction. Also, the tube between the dispenser and automatic ice maker may freeze.

To move refrigerator through a house door, it may be necessary to remove refrigerator and freezer door handles.

**Tools Required**

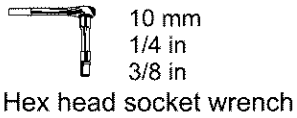

Hex head socket wrench



Phillips screwdriver



Flat head screwdriver

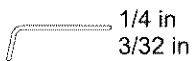

Allen wrench

**1. Removing Refrigerator Handle**

- Loosen the set screws with the 3/32" Allen wrench and remove the handle.  
**NOTE:** If the handle mounting fasteners need to be tightened or removed, use a 1/4 Allen wrench.

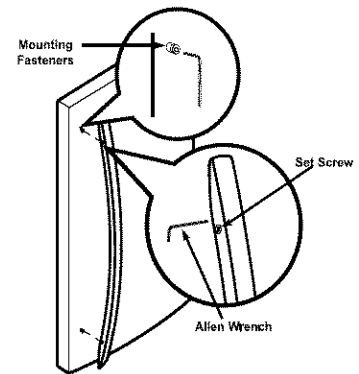

**Warning**

**Door removal**

**Electric Shock Hazard**

Disconnect electrical supply to refrigerator before installing. Failure to do so could result in death or serious injury.

**If your entrance door is too narrow for the refrigerator to pass through, remove the refrigerator door and pass the refrigerator laterally.**

Remove the lower cover by lifting upward, and then pull up the water feed tube while pressing area ① shown in the figure to the right.

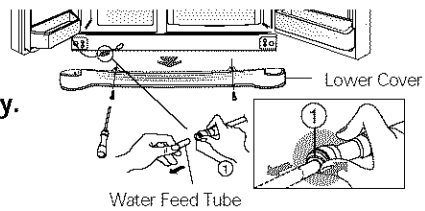

**NOTE**

- If a tube end is deformed or abraded, trim the part away.
- Disconnecting the tube under the door causes about 1.5 liters water to flow out. Please put a large container at end of tube to prevent water from draining on to the floor.

**Remove Lower Cover and Water Feed Tube**

**Remove the Freezer Compartment Door**

1) Remove the hinge cover by loosening the screws. Disconnect all connections except the ground line.

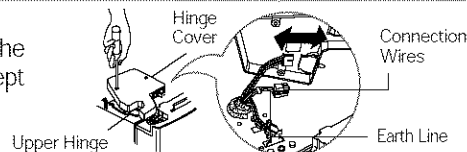

2) Remove the keeper by rotating it counter clockwise ① and then lifting the upper hinge up ②.

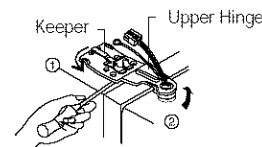

**NOTE**

- When removing the upper hinge, be careful that the door does not fall forward.

3) Remove the freezer compartment door by lifting it upward. This time, the door should be lifted enough for the water feed tube to be completely pulled out.

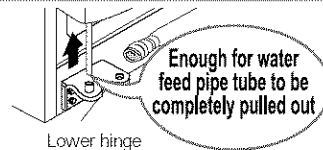

**NOTE**

- After removing the door, take it into the kitchen where you are installing the refrigerator. Lay it down on a blanket and be careful to avoid damaging the water feed tube.

**Remove the Refrigerator Door**

1) Loosen the hinge cover screws and remove the cover. Remove connection wire.

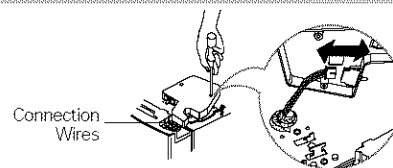

2) Remove keeper by rotating it clockwise ① and then remove the upper hinge by lifting it up ②.

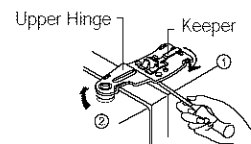

3) Remove the refrigerator compartment door by lifting it up.

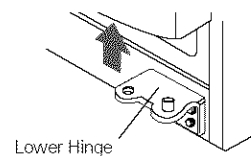

## Move the Refrigerator

Push the refrigerator sideways through the entrance door as shown in the right picture.

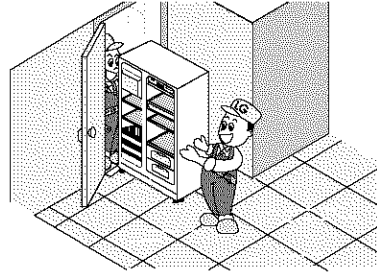

## Door replacement

Mount the doors in the reverse order of removal after the refrigerator is brought to the installation area.

### NOTE:

Check the direction of the lever hinge.

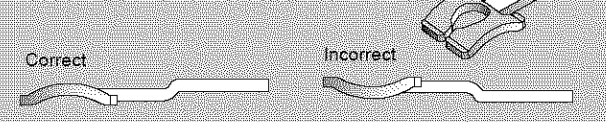

## Feed water tube installation

### Before Installation

- Automatic icemaker operation needs water pressure of 21.3~121psi(lb/inch<sup>2</sup>) (That is, a 7oz. paper cup will be filled within 3 sec.).
- If water pressure does not reach the rated 21.3psi(lb/inch<sup>2</sup>) or below, it is necessary to purchase a separate pressure pump for normal automatic icemaking and cool water feed.
- Keep the total length of the water feed tube within 40 feet and be careful not to bend or kink the tube. If the tube is longer than 40 feet, the icemaker and water dispenser will not operate properly.
- Install the water feed tube at a place free from heat.

- Connect to potable water supply only.
- Refer to instructions with water filter kit for installation.

## Warning

### Connecting the Refrigerator to a Water Source

## Water Connection Instruction Guide

Read all directions carefully before you begin.

### IMPORTANT

- If operating the refrigerator before installing the water connection, turn icemaker to the OFF position to prevent operation without water.
- All installations must be in accordance with local plumbing code requirements.
- Use copper tubing and check for leaks.
- Install copper tubing only in areas where temperatures will remain above freezing.
- It may take up to 24 hours for your icemaker to begin producing ice.

### Tools Required



Screwdriver

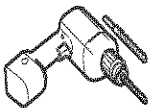

Electric drill



Adjustable wrenches

- Standard screwdriver
- 7/16-inch and 1/2-inch open-end wrenches or two adjustable wrenches
- 1/4-inch nut driver
- 1/4-inch drill bit
- Hand drill or electric drill (properly grounded)

### NOTE

In order to perform the water connection you will need to buy: a 1/4-inch saddle-type shut off valve, a union, and copper tubing. Before purchasing, make sure the saddle-type valve complies with your local plumbing codes. Do not use a piercing-type or 3/16-inch saddle valve which reduces water flow and clogs more easily.

**Connect the Tubing to Water Line**

1. Unplug refrigerator or disconnect power.
2. Turn OFF main water supply. Turn on the nearest faucet to relieve the pressure on the line. It may help to open an outside faucet to allow the water to drain from the line in the house.
3. Find a 1/2-inch to 1-1/4-inch vertical COLD water pipe near the refrigerator.

**NOTE**

• Horizontal pipe will work, but the following precaution must be taken: Drill on the top of the pipe not the bottom. This will help keep water away from the drill. This also keeps normal sediment from collecting in the valve.

4. To determine the length of copper tubing you will need, measure from the connection on the lower left rear of the refrigerator to the water pipe. Add 7 feet (2.1m) to allow for moving refrigerator for cleaning. Use 1/4-inch O.D. (outside diameter) copper tubing. Be sure both ends of copper tubing are cut square.
5. Using a drill, drill a 1/4-inch hole in the cold water pipe you have selected.
6. Fasten shut-off valve to cold water pipe with pipe clamp. Be sure outlet end is solidly in the 1/4-inch drilled hole in the water pipe and that the washer is under the pipe clamp. Tighten packing nut. Tighten the pipe clamp screws carefully and evenly so washer makes a watertight seal. Do not overtighten or you may crush the copper tubing, especially if soft (coiled) copper tubing is used. Now you are ready to connect copper tubing.
7. Slip compression sleeve and compression nut on copper tubing as shown. Insert end of tubing into outlet end squarely as far as it will go. Screw compression nut onto outlet end with adjustable wrench. Do not over tighten.
8. Place the free end of the tubing into a container or zinc, and turn ON main water supply and flush out tubing until water is clear. Turn OFF shutoff valve on the water pipe. Coil the copper tubing as shown below.

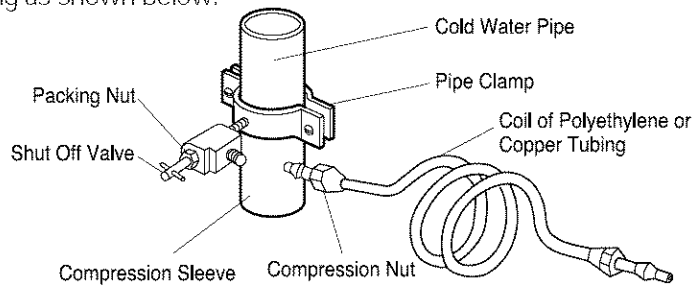

**Operation Instruction Guide**

**Before making the connection to the refrigerator, be sure the refrigerator power cord is not plugged into the wall outlet.**

- If your refrigerator does not have a water filter, we recommend installing one. If your water supply has sand or particles that could clog the screen of the refrigerator's water valve. Install the filter in the water line near the refrigerator.

1. Remove the plastic flexible cap from the water valve.
2. Place the compression nut and ferrule (sleeve) onto the end of the tubing as shown.
3. Insert the end of the copper tubing into the connection as far as possible. While holding the tubing, tighten the fitting.

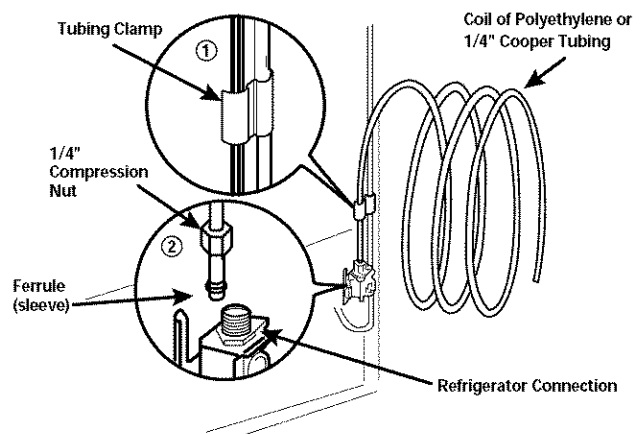

**Connect the Tubing to the Refrigerator**

**Turn the Water On at the Shut off Valve****Tighten any connections that leak.**

- **Plug In the Refrigerator**

Arrange the coil of copper tubing behind the refrigerator so it does not vibrate against the back of the refrigerator or against the wall. Push the refrigerator back to the wall.

- **Start the Icemaker**

Set the icemaking stop switch to the ON position. The icemaker will not begin to operate until it reaches its operating temperature of 15 °F (-9 °C). It will then begin operation automatically, if the icemaking stop switch is in the ON position.

**Automatic Ice maker**

- The automatic icemaker makes 8 cubes at a time, 120/150 pieces per day. But these quantities may vary according to circumstance, including ambient temperature, door openings, freezer load.etc.
- The Icemaker stops when the bin is full.

**NOTE**

- It is normal to hear a noise when ice drops into the bin.

**When Icemaker Does Not Operate Smoothly****The unit is newly installed**

- It takes about 12 hours for a newly installed refrigerator to make ice.

**Ice is lumped together**

- If ice is not used frequently, it may lump together.
- When ice is lumped together, take the ice lumps out of the ice storage bin, break them into small pieces, and then place them into the ice storage bin again.
- When the icemaker produces too small or lumped ice, the amount of water supplied to the ice maker must be adjusted. Contact the service center.

**Power failure**

- Water may drop into the freezer compartment. Take the ice storage bin out and discard all the ice. Dry the bin and replace it.

**⚠ CAUTION**

The first ice and water may include particles or odor from the feed water pipe or feed water box. Throw away the ice.

This is also necessary if the refrigerator has not been used for a long time.

Never store beverage cans or other foods in ice storage bin for the purpose of rapid cooling. Such actions may damage the automatic ice maker.

Never remove the icemaker cover.

Shake the bin occasionally to cause the ice to settle.

Ice may pile up just around the icemaker causing the icemaker to think that the ice storage bin is full.

If discolored ice is dispensed, contact an Authorized Service Center immediately. Do not use the ice or water until the problem is corrected.



## Height adjustment

(First identify your screw type, it could vary)

Make them level by inserting flat (- type) driver into the groove of the left height adjusting screw and rotating it clockwise (⌚).

If the freezer compartment door is lower than the refrigerator compartment door

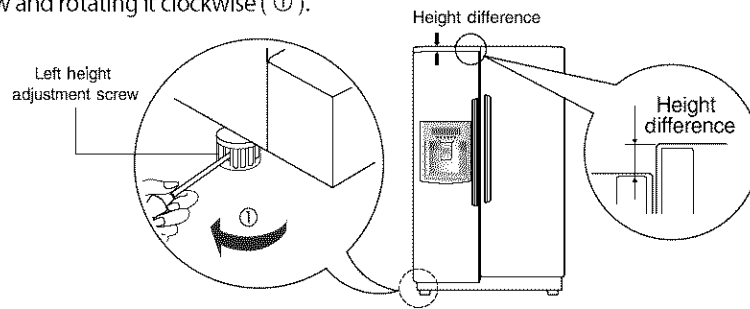

If the freezer compartment door is higher than the refrigerator compartment door

- Type 1

Make them level by inserting flat (- type) driver into the groove of the right height adjusting screw and rotating it clockwise (⌚).

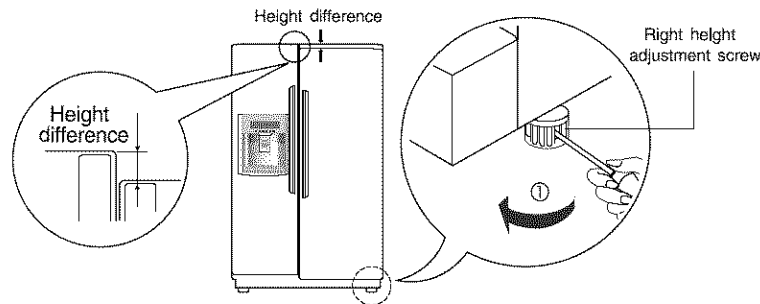

If the freezer compartment door is higher than the refrigerator compartment door

- Type 2

Adjust the level when the refrigerator door is lower than the freezer door during the use of the refrigerator.

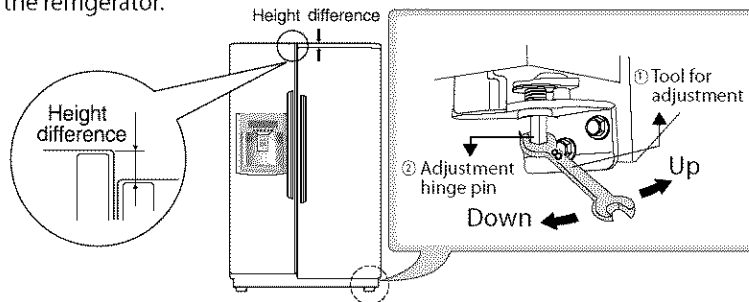

1. Using the narrow side of the tool for adjustment, turn the adjustment hinge pin (2) (↻) clockwise or (↺) counterclockwise to level the refrigerator and freezer door.
2. After setting the level of the door, turn the keeper nut (↻) counterclockwise to tighten.

### CAUTION

Do not force too hard to level the height. The hinge pin can be pulled out. (Adjustable range of height is a maximum of 1/2" (1,27 cm))

After leveling the door height

The refrigerator door will close smoothly by raising the front side by adjusting the height adjusting screw. If the door does not close properly because it is improperly adjusted, the performance of the refrigerator will be affected.

# Starting

When your refrigerator is first installed, allow it to stabilize at normal operating temperatures for 2-3 hours prior to filling it with fresh or frozen foods. If operation is interrupted, wait 5 minutes before restarting.

# Adjusting The Temperatures and Functions

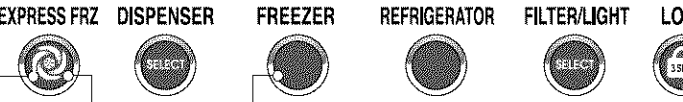
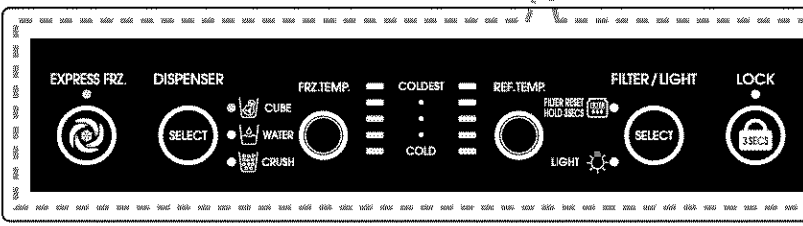
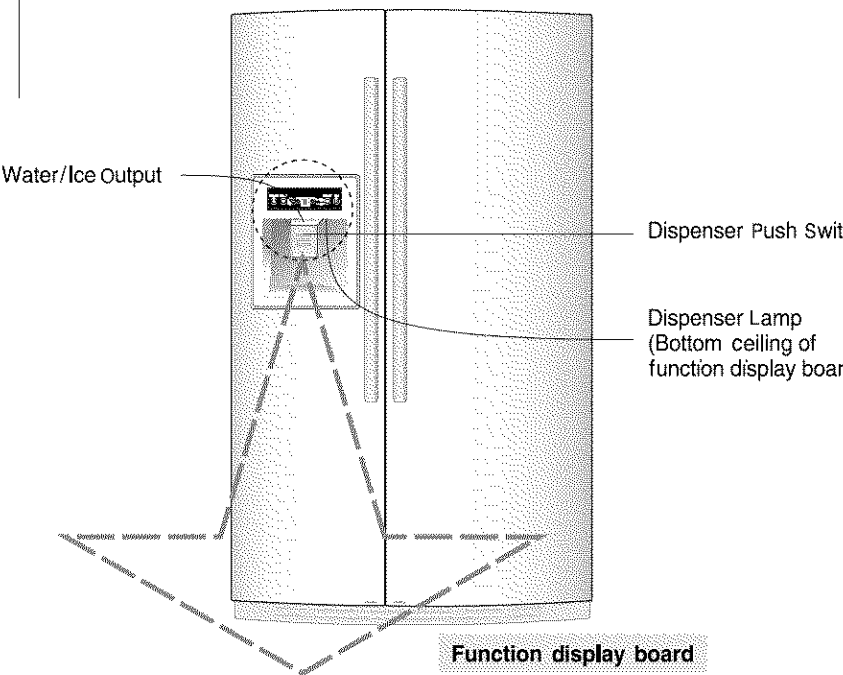

① Buzzer sound mute Mode

② Display Off Mode

**NOTE:**  
Images may vary between models, display functions remain the same.

Different kind of graphics

1. Buzzer sound mute Mode  
 The buzzer sound is set to OFF.  
 It activates by sounding the recognition sound of "Ding~" after pressing and holding "Express FRZ" button more than 5 seconds.  
 It inactivates when resetting the mode power.
2. Display Off Mode  
 It places display in standby mode until door is opened.  
 Press "Freezer" and "Express FRZ" buttons simultaneously to turn all leds ON and then OFF with the recognition sound of "Ding~" after 5 seconds.  
 Once the mode activates, the display is OFF. Until door is opened or display button is pressed. When 30 seconds has elapsed after closing door or pressing button, the display turns OFF.  
 To deactivate this mode is same as the activation methods. The mode inactivates when resetting the power.

You can adjust temperature of freezer compartment and refrigerator Compartment.

**How to adjust the temperature in the freezer compartment**

**Freezer Compartment temperature adjustment**

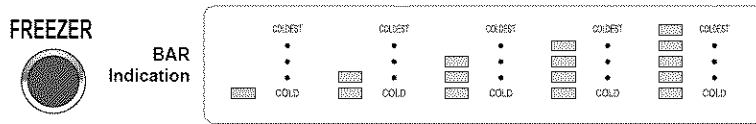

**How to adjust the temperature in the refrigerator compartment**

**Refrigerator Compartment temperature adjustment**

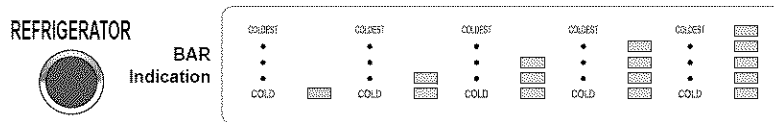

- \* Whenever pressing button, setting is repeated in the order of (Middle) → (Middle Strong) → (Strong) → (Weak) → (Middle Weak).
- The actual inner temperature varies depending on the food status, as the indicated setting temperature is the target temperature, not actual temperature within refrigerator.
- Please adjust temperature as above after using refrigerator for minimum 2~3 days.

**Dispenser selection**

You can select water or ice.

- \* Please select water, Crushed ice, or cubed ice by pressing  button as you desire.
- \* Please press the button gently by pushing in cup.
  - You will hear a clap when the ice door closes after ice is dispensed.

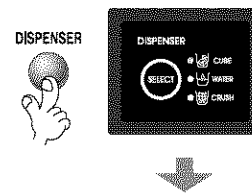

- Reference : Hold your cup in place for a couple of seconds after dispensing ice or water so the last few drops go in your cup instead of on the floor.

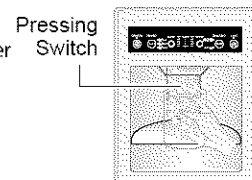

**Automatic Icemaker**

- The automatic icemaker can automatically make 8 cubes at a time, 120~150 pieces per day. This quantity may vary by circumstance, including ambient temperature, door opening, freezer load. etc.
- Icemaking stops when the ice storage bin is full.
- If you don't want to use automatic icemaker, turn the icemaker switch to OFF. If you want to use automatic ice-maker again, change the switch to ON. To switch ON/OFF follow steps 1 & 2 in the picture.

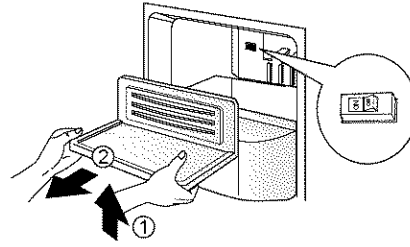

**NOTE**

It is normal that a noise is produced when ice drops into the ice storage bin.

**When ice maker does not operate smoothly**

The unit is newly installed

- It takes about 12 hours for a newly installed refrigerator to make ice.

Ice is lumped together

- If ice is not used frequently, it may lump together.
- If the ice lumps together, take it out, break it apart, and put it back into the storage bin.
- When the ice maker produces too small or lumped together ice, the amount of water supplied to the ice maker needs to be adjusted. Contact the service center.

Power failure

- Ice may drop into the freezer compartment. Take the ice storage bin out and discard all the ice then dry it and place it back. After the machine is powered again, crushed ice will be automatically selected.

**Ice Plus**

Please select this function for prompt freezer.

- "OFF — ON — OFF" is repeated whenever pressing ICE PLUS button.
- The arrow mark graphic remains at the On status after flickering 4 times when selecting Special Refrigeration On
- Prompt freezer function automatically turns off after a fixed time passes.

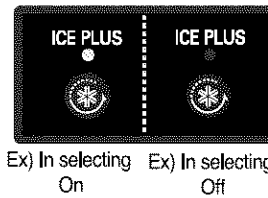

**Lock**

This button stops operation of different button and dispenser function.

- Locking or Release is repeated whenever the LOCK button is pressed more than 3 seconds.
- If you use the LOCK button, none of the other buttons will work until you unlock them.

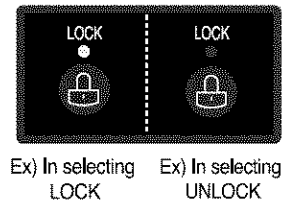

**The Other Functions**

Door open warning

- A warning tone will sound 3 times at thirty-second intervals if the refrigerator or freezer door is left open for more than sixty seconds.
- Please contact the local service center if warning tone continues to sound even after closing the door.

Diagnosis (failure detection) function

- Diagnosis function automatically detects failure during the normal use of refrigerator.
- If your refrigerator fails, do not turn off the power. Instead, contact a local Authorized service center or call our support line for assistance. Turning off the appliance will make it more difficult for the service technician to determine the problem.

**How Ice/Cold Water is Supplied**

Water is cooled while stored in the water tank in freezer door, and then sent to the dispenser.

Ice is made in the automatic icemaker and sent to the dispenser divided into crushed or cubed ice.

**How to Use Dispenser**

- Select among crushed ice, water, and cubed ice and press the push switch with a glass or other container.

**Water**

Light the water lamp by pressing the selection button.

- Water will be dispensed by pressing the push switch with a glass.

**Crushed Ice**

Light the crushed ice lamp by pressing the selection button.

- Crushed ice will be dispensed by pressing the push switch with a glass.

**Cubed Ice**

Light the cubed ice lamp by pressing the selection button.

- Cubed ice will be dispensed by pressing the push switch with a glass.

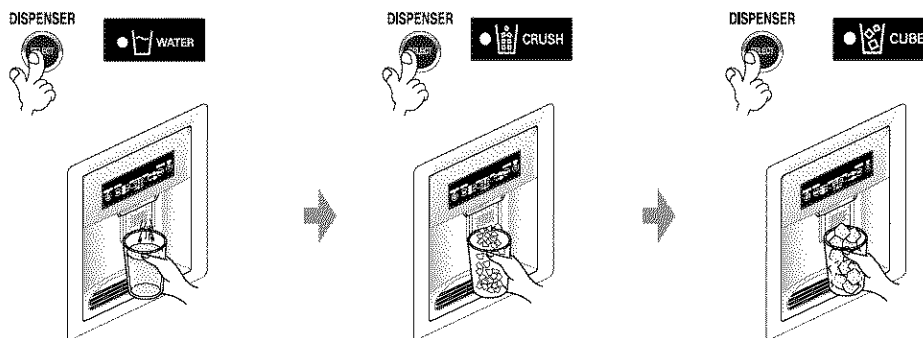

- Reference : Hold your cup in place for a couple of seconds after dispensing ice or water so the last few drops go in your cup instead of on the floor.

**Filter Condition (filter replacement cycle) Display Function**

LED

- There is a replacement indicator light for the water filter cartridge on the dispenser.
- Water filter needs replacement once every six months.
- Filter light comes on to let you know when to replace filter.
- After replacing the filter, press and hold the lock button more than 3seconds. FILTER RESET, HOLD 3 SECS text turn off filter light.

Classification

Filter Status Display

In initial Power On / Filter RESET	Replace indicator light on
FILTER RESET HOLD 3 SECS	FILTER RESET HOLD 3 SECS

**⚠ Cautions**

**Throw away the ice (about 20 pieces) and water (about 7 glasses) first made after refrigerator installation.**

This is also necessary when the refrigerator has not been used for a long time.

**Keep children away from the dispenser.**

Children may play with or damage the controls.

**Be careful that food does not block the ice passage.**

If foods are placed at the entrance of ice passage, the dispenser may malfunction. The passage may also become blocked with frost if only crushed ice is used. Remove the frost that accumulates.

**Storing cans or other items in the ice bin may damage the icemaker or the container may burst.**

**Never use thin crystal glass or crockery to collect ice.**

Such glasses or containers may break.

**Put ice first into a glass before filling water or other beverages.**

Water may be splashed if ice is added to existing liquid in a glass.

**Keep your hands and tools out of the ice door and passage.**

You might break something or injure yourself.

**Never remove the ice maker cover.**

**Shake the ice bin occasionally to level the ice in it.**

Sometimes the ice piles up near the icemaker, causing the icemaker to misread the bin level and stop producing ice.

**If discolored ice or water is dispensed, contact an Authorized service center immediately and discontinue use until the problem is corrected.**

**Never use too narrow or shallow glass.**

Ice may be jammed in ice passage and, thus, the ice maker may fail.

**Keep the glass at a proper distance from ice outlet.**

A glass too close to the outlet may hinder ice from coming out.

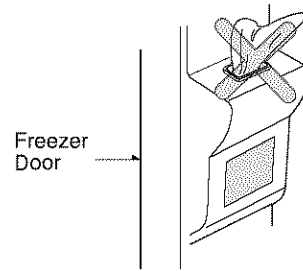

**Shelf**

The refrigerator compartment shelf is adjustable so that you can place it at a height according to space requirement of foods.

**Shelf Height Adjustment**

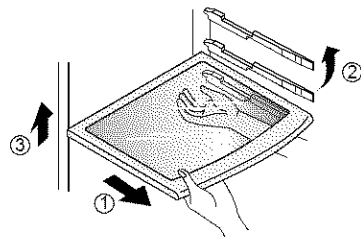

- Slide Shelf  
Pull the shelf ahead and take it out while lifting both front and rear part.

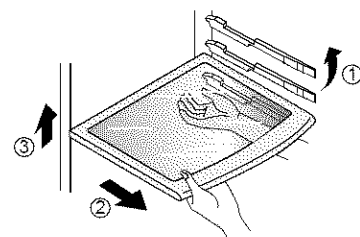

- Fix Shelf  
Lightly lift up the front part of shelf to pull it ahead and then take it out while lifting the rear part of shelf.

**NOTE**

• Make sure the shelf is horizontal. If not, it may drop.

## Location of Foods

(Refer to Identification of Parts)

### Snack Drawer

Store small foods such as bread, snacks, etc.

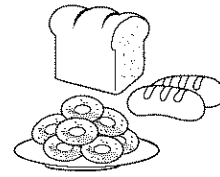

### Freezer Compartment Shelf

Store various frozen foods such as meat, fish, ice cream, frozen snacks, etc.

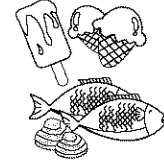

### Freezer Compartment Door Rack

- Store small packed frozen food.
- Temperature is likely to increase as door opens. So, do not store long-term food such as ice cream, etc.

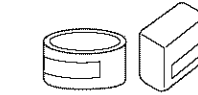

### Freezer Compartment Drawer

- Store meat, fish, chicken, etc. after wrapping them with foil.
- Store dry.

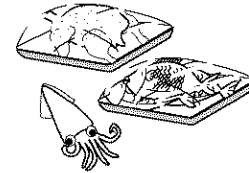

### Milk Product Corner

Store milk products such as butter, cheese, etc.



### Refreshment Center

Store foods of frequent use such as beverage, etc.



### Refrigerator Compartment Shelf

Store side dishes or other foods.

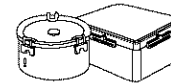

### Refrigerator Compartment Door Rack

Store small packed food or beverages such as milk, juice, beer, etc.

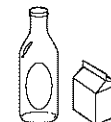

### Vegetable Drawer

Store vegetables or fruits.

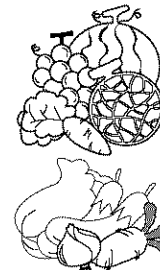

## Storing Foods

- Store fresh food in the refrigerator compartment. How food is frozen and thawed is an important factor in maintaining its freshness and flavor.
- Do not store food, which spoils easily, at low temperatures, such as bananas and melons.
- Allow hot food to cool prior to storing, placing hot food in the refrigerator could spoil other food, and lead to higher energy consumption.
- When storing the food, cover it with vinyl wrap or store in a container with a lid. This prevents moisture from evaporating, and helps food to keep its taste and nutrients.
- Do not block air vents with food. Smooth circulation of chilled air keeps refrigerator temperatures even.
- Do not open the door frequently. Opening the door lets warm air enter the refrigerator, and cause temperatures to rise.
- Never keep too much food in door rack because they may be pushed against the inner racks and the door would not be fully closed.

### Freezer Compartment

- Do not store bottles in the freezer compartment - they may break when frozen.
  - Do not refreeze food that has been thawed. This causes loss of taste and nutrient.
  - When storing frozen food like ice cream for a long period, place it on the freezer shelf, not in the door rack.
  - Do not touch the cold foods or containers- especially made of metal -, with wet hands and place glass products in the freezer compartment.
- That's why you may have chilblains and they may be broken when their inner matters are frozen, causing personal injury.

### Refrigerator Compartment

- Avoid placing moist food in top refrigerator shelves, it could freeze from direct contact with chilled air.
- Always clean food prior to refrigeration. Vegetables and fruits should be washed and wiped, and packed food should be wiped, to prevent adjacent food from spoiling.
- When storing eggs in their storage rack or box, ensure that they are fresh, and always store them in an upright position, which keeps them fresh longer.

#### NOTE

- If you keep the refrigerator in a hot and humid place, frequent opening of the door or storing a lot of vegetables in it may cause condensation to form. Remove the condensation with dust free cloth.

## How to Dismantle Parts

### NOTE

- Dismantling is done in the reverse sequence of assembly.
- Be sure to unplug the power plug before dismantling and assembly.
- Never apply severe force to dismantle parts. Parts may be damaged.

#### Freezer Compartment Lamp

Remove cover by pressing upward on bottom ① and rotating outward ②.  
Turn the bulb counterclockwise. Max. 40 W bulb for refrigerator is used and can be purchased at a service center.

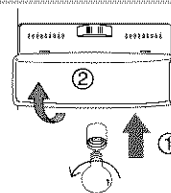

#### Dispenser Lamp

Separate the lamp by pulling it out, and then remove the lamp. Max. 15 W bulb for refrigerator is used and can be purchased at a service center.

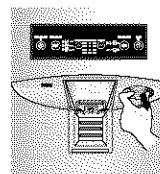

#### Freezer Compartment Shelf

To remove a shelf, Lift the left part of the shelf a bit. Lift it to the direction ①, push the right part to the direction ②, and take it out.

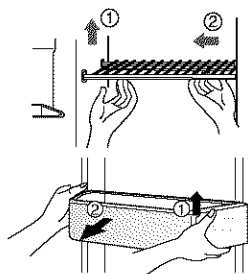

#### Door Rack and Support

Lift the door rack holding both sides ① and pull it out to ② direction.

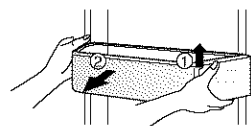

#### Ice Storage Bin

Lift the ice shelf as shown in the right figure ① and pull it out ②.

Hold the ice storage bin as shown in the right figure and pull it out while slightly lifting it.

To assemble the ice storage bin, push it ③ while slightly lifting it ④.

- It is recommended not to dismantle the ice storage bin unless it is necessary.
- Use both hands to remove the ice bin to avoid dropping it.
- If the ice bin does not slide into place easily, twist the drive device slightly.

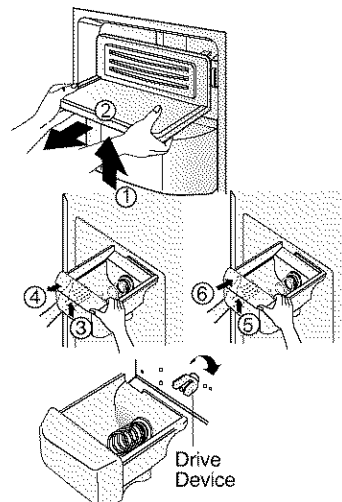

#### After Dispenser Is Used

The water collector has no self-draining function. It should be cleaned regularly. Remove the cover by pulling the front side of water collector cover and dry it with a cloth.

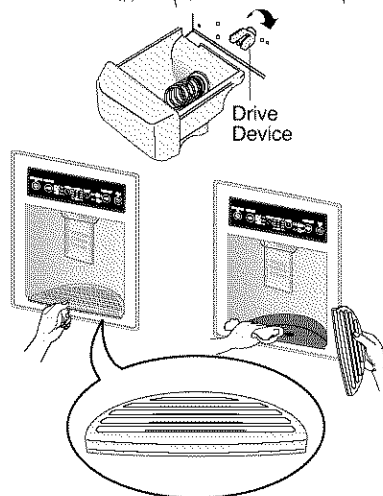

**Lamp in Refrigerator Compartment**

To remove the lamp cover, press the protrusion under the lamp cover to the front and then pull the lamp cover out. Turn the bulb counterclockwise. Max. 40 W bulb for refrigerator is used and can be purchased at a service center.

**NOTE**

• Be sure to remove parts from the refrigerator door when removing the vegetable compartment, snack drawer, and refreshment center cover.

**Vegetable Compartment Cover**

▪ To remove the vegetable compartment cover, pull out the vegetable compartment a bit to the front ①, lift the front part of the vegetable compartment cover as shown by ②, and take it out.

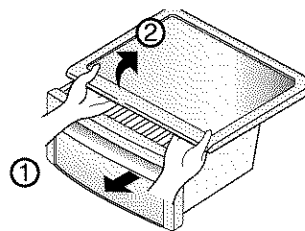

**Water Plumbing**

**1) Before installing water filter**

Take out the top shelf and move it to the lower part. Remove the lamp cover by pressing the protrusion under the cover and pulling the cover to the front.

**2) Installing water filter**

**A)** Remove filter substitute cap ( D ) by turning it counterclockwise by 90 degrees 1 and pulling it down 2

**3) Replacing filter cartridge**

**A)** Before replace the water filter is necessary shutoff valve off (house valve).

**B)** Dispense water from the system to empty the tubing (approximately for 50 seconds).

**C)** Remove the old one by **slowly** turning it to the left. The unlocked symbol will be line up with indicator line that is molded into the control box area, then pull it down.

NOTE 1. Check that the guideline and the loosening indication line are aligned.

**4) Installation Filter Cartridge**

**A)** Apply the month sticker ( E ) to the cartridge as a reminder to replace the filter within six months and remove red cap ( F ).

**B)** Line up the cartridge ears so that it can be inserted into the filter head.

Twist the cartridge ¼ turn clockwise to lock it into place. You will feel a stop and the locked symbol should now be line up with the indicator line.

Check that the guideline and the fastening indication line are aligned.

**5) After installing water filter**

**A)** Move the cover lamp and shelf to the initial position.

**B)** Dispense water trough the dispenser for 3 minutes to purge the system.

Open the refrigerator door and check the shelf area for leaks.

**C)** After install water filter turn the shutoff valve on (house valve).

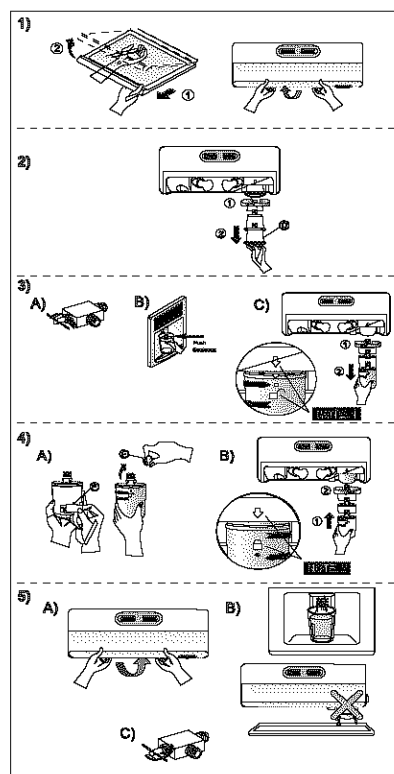

## General Information

### Vacation Time

During average length vacations, you will probably find it best to leave the refrigerator in operation. Place freezable items in freezer for longer life. When you plan to store the refrigerator, remove all food, disconnect the power cord, clean the interior thoroughly, and Block the doors open to prevent mold and mildew. Be certain the stored refrigerator does not present a child entrapment danger.

### Power Failure

Most power failures that are corrected in an hour or two will not affect your refrigerator temperatures. However, you should minimize the number of door openings while the power is off.

### If You Move

Remove or securely fasten down all loose items inside the refrigerator. To avoid damaging the height adjusting screws, turn them all the way into the base.

### Anti-Condensation Pipe

The outside wall of the refrigerator cabinet may sometimes get warm, especially just after installation. Don't be alarmed. This is due to the anti-condensation pipe, which pumps hot refrigerant to prevent sweating on the outer cabinet wall.

## Cleaning

It is important that your refrigerator be kept clean to prevent undesirable odors. Spilled food should be wiped up immediately, since it may acidify and stain plastic surfaces if allowed to settle.

### Exterior

Use a lukewarm solution of mild soap or detergent to clean the durable finish of your refrigerator. Wipe with a clean damp cloth and then dry.

### Interior

Regular cleaning is recommended. Wash all compartments with a baking soda solution or a mild detergent and warm water. Rinse and dry. If you use other substances for cleaning, your refrigerator could be damaged.

### After Cleaning

Please verify that the power cord is not damaged, power plug is not overheated, or power plug is well inserted into the power socket.

### Warning

Always remove power cord from the wall outlet prior to cleaning in the vicinity of electrical parts (lamps, switches, controls, etc.). Wipe up excess moisture with a sponge or cloth to prevent water or liquid from getting into any electrical part and causing an electric shock. Never use metallic scouring pads, brushes, coarse abrasive cleaners, strong alkaline solutions, flammable or toxic cleaning liquids on any surface. Do not touch frozen surfaces with wet or damp hands, because damp object will stick or adhere to extremely cold surfaces.



## Troubleshooting

Before calling for service, review this list. It may save you both time and expense. This list includes common occurrences that are not the result of defective workmanship or materials in this appliance.

Occurrence	Possible cause	Solution
<b>Runing of refrigerator</b>		
<b>Refrigerator compressor does not run.</b>	Refrigerator control is off.	Set refrigerator control. See setting the controls.
	Refrigerator is in defrost cycle.	This is normal for a fully automatic defrosting refrigerator. The defrost cycle occurs periodically.
	Plug at wall outlet is disconnected.	Make sure plug is tightly pushed into outlet.
	Power outage. Check house lights.	Call local electric company.
<b>Refrigerator runs too often or too long</b>	Refrigerator is larger than the previous one you owned.	This is normal. Larger, more efficient units run longer in these conditions.
	Room or outside weather is hot.	It is normal for the refrigerator to work longer under these conditions.
	Refrigerator has recently been disconnected for a period of time.	It takes some hours for the refrigerator to cool down completely.
	Large amounts of warm or hot food may have been stored recently.	Warm food will cause the refrigerator to run longer until the desired temperature is reached.
	Doors are opened too frequently or too long.	Warm air entering the refrigerator causes it to run longer. Open the door less often.
	Refrigerator or freezer door may be slightly open.	Make sure the refrigerator is level. Keep food and containers from blocking door. See problem section, OPENING/CLOSING of doors.
	Refrigerator control is set too cold.	Set the refrigerator control to a warmer setting until the refrigerator temperature is satisfactory.
	Refrigerator or freezer gasket is dirty, worn, cracked, or poorly fitted.	Clean or change gasket. Leaks in the door seal will cause refrigerator to run longer in order to maintain desired temperatures.

Occurrence	Possible cause	Solution
------------	----------------	----------

**Temperatures are too cold**

Temperature in the freezer is too cold but the refrigerator temperature is satisfactory.	Freezer control is set too cold.	Set the freezer control to a warmer setting until the freezer temperature is satisfactory.
Temperature in the refrigerator is too cold and the freezer temperature is satisfactory.	Refrigerator control is set too cold.	Set the refrigerator control to a warmer setting.
Food stored in drawers freezes.	Refrigerator control is set too cold.	See above solution.

**Temperatures are too warm**

Temperatures in the refrigerator or freezer are too warm.	Freezer control is set too warm.	Set the freezer or refrigerator control to a colder setting until the freezer or refrigerator temperature is satisfactory.
	Refrigerator control is set too warm. Refrigerator control has some effect on freezer temperature.	Set the freezer or refrigerator control to a colder setting until the freezer or refrigerator temperature is satisfactory.
	Doors are opened too frequently or too long.	Warm air enters the refrigerator/ freezer whenever the door is opened. Open the door less often.
	Door is slightly open.	Close the door completely.
	Large amounts of warm or hot food may have been stored recently.	Wait until the refrigerator or freezer has a chance to reach its selected temperature.
	Refrigerator has recently been disconnected for a period of time.	A refrigerator requires some hours to cool down completely.
Temperature in the refrigerator is too warm but the freezer temperature is satisfactory.	Refrigerator control is set too warm.	Set the refrigerator control to a colder setting.

Occurrence	Possible cause	Solution
<b>Sound and noise</b>		
<b>Louder sound levels when refrigerator is on.</b>	Today's refrigerators have increased storage capacity and maintain more even temperatures.	It is normal for sound levels to be higher.
<b>Louder sound levels when compressor comes on.</b>	Refrigerator operates at higher pressures during the start of the ON cycle.	This is normal. The sound will level off as the refrigerator continues to run.
<b>Vibrating or rattling noise.</b>	Floor is uneven or weak. Refrigerator rocks on the floor when it is moved slightly.	Be sure floor is level and solid and can adequately support refrigerator.
	Items placed on the top of the refrigerator are vibrating.	Remove items.
	Dishes are vibrating on the shelves in the refrigerator.	Move dishes slightly. Make sure refrigerator is level and firmly set on floor.
	Refrigerator is touching wall or cabinets.	Move refrigerator so that it does not touch the wall or refrigerator.

**Water/Moisture/Ice inside refrigerator**

<b>Moisture collects on the inside walls of the refrigerator.</b>	The weather is hot and humid which increases the rate of frost buildup and internal sweating.	This is normal.
	Door is slightly open.	See problem section opening/closing of doors.
	Door is opened too often or too long.	Open the door less often.

**Water/Moisture/Ice outside refrigerator**

<b>Moisture forms on the outside of the refrigerator or between doors.</b>	Weather is humid.	This is normal in humid weather. When humidity is lower, the moisture should disappear.
	Door is slightly open, causing cold air from the inside the refrigerator to meet warm air from the outside.	This time, close the door completely.

Occurrence	Possible cause	Solution
------------	----------------	----------

**Odors in refrigerator**

	Interior needs to be cleaned.	Clean interior with sponge,warm water and baking soda.
	Food with strong odor is in the refrigerator.	Cover food completely.
	Some containers and wrapping materials produce odors.	Use a different container or brand of wrapping materials.

**Opening/Closing of doors/Drawers**

<b>Door(s) will not close.</b>	Food package is keeping door open.	Move packages that keep door from closing.
<b>Door(s) will not close.</b>	Door was closed too hard, causing other door to open slightly.	Close both doors gently.
	Refrigerator is not level. It rocks on the floor when it is moved slightly.	Adjust the height adjusting screw.
	Floor is uneven or weak. Refrigerator rocks on the floor when it is moved slightly.	Be sure floor is level and can adequately support refrigerator. Contact carpenter to correct sagging or sloping floor.
<b>Drawers are difficult to move.</b>	Refrigerator is touching wall or cabinets.	Move refrigerator..
	Food is touching shelf on top of the drawer	Keep less food in drawer.
	Track that drawer slides on is dirty.	Clean drawer and track.

**Dispenser**

<b>Dispenser will not dispense ice</b>	Ice storage bin is empty.	When the first supply of ice is dropped into the bin, the dispenser should operate.
	Freezer temperature is set too warm.	Turn the freezer control to a higher setting so that ice cubes will be made. When the first supply of ice is made, the dispenser should operate.
	Household water line valve is not open.	Open household water line valve and allow sufficient time for ice to be made. When ice is made, dispenser should operate.
	Refrigerator or freezer door is not closed.	Be sure both doors are closed.

Occurrence	Possible cause	Solution
<b>Dispenser will not dispense ice.</b>	Ice has melted and frozen around auger due to infrequent use, temperature fluctuations and/or power outages.	Remove ice storage bin, and thaw and the contents. Clean bin, wipe dry and replace in proper position. When new ice is made, dispenser should operate.
<b>Ice dispenser is jammed.</b>	Ice cubes are jammed between the ice maker arm and back of the bin.	Remove the ice cubes that are jamming the dispenser.
	Ice cubes are frozen together.	Use the dispenser often so that cubes do not freeze together.
	Ice cubes that have been purchased or made in some other way have been used in the dispenser.	Only the ice cubes made by the ice maker should be used with the dispenser.
<b>Dispenser will not dispense water.</b>	Household water line valve is not open. See problem Icemaker is not making any ice.	Open household water line valve.
	Refrigerator or freezer door is not closed.	Be sure both doors are closed.
<b>Water has an odd taste and/or odor.</b>	Water has been in the tank for too long.	Draw and discard 7 glasses of water to freshen the supply. Draw and discard an additional 7 glasses to completely rinse out tank.
	Unit not properly connected to cold water line.	Connect unit to cold water line which supplies water to kitchen faucet.
<b>Sound of ice dropping.</b>	This sound is normally made when automatically made ice is dropped into ice storage bin. Volume may vary according to refrigerator's location.	
<b>Sound of water supply.</b>	This sound is normally made when ice maker is supplied with water after dropping the automatically made ice.	
<b>Other.</b>	Please thoroughly read Automatic icemaker and dispenser in this manual.	

**ONLY UNITED STATES**<http://www.lgservice.com>**CUSTOMER ASSISTANCE NUMBERS:**

- To Prove Warranty Coverage  
Retain your Sales Receipt to prove date of purchase.  
A copy of your Sales Receipt must be submitted at the time warranty service is provided.
- To Obtain Product, Customer or Service Assistance  
Call Toll-free for Customer Service  
Tel : 1-800-243-0000
- To Obtain Nearest Authorized Service Center  
Call 1-800-243-0000, push option #1, 24 hours a day, 7days per week.  
Please have your product type (Monitor, TV, VCR, MWO, Refrigerator) and ZIP code ready.

## LIMITED WARRANTY United States of America

LG Electronics will repair or at its option replace, without charge, your product which proves to be defective in material or workmanship under normal use during the warranty period listed below from the date of original purchase.

This warranty is good only to the original purchaser of the product during the warranty period as long as it is in the U.S. including Alaska, Hawaii, and U.S. Territories.

### LG Refrigerator / Freezer Warranty Period

Product	Parts	Labor
Refrigerator / Freezer	1 year	1 year [In-Home Service (Except Model GR-051)]
Sealed System (Compressor, Condenser, Evaporator)	7 years	1 year [In-Home Service (Except Model GR-051)]

No other express warranty is applicable to this product. THE DURATION OF ANY IMPLIED WARRANTIES, INCLUDING THE IMPLIED WARRANTY OF MERCHANTABILITY, IS LIMITED TO THE DURATION OF THE EXPRESS WARRANTY HEREIN. LG ELECTRONICS SHALL NOT BE LIABLE FOR THE LOSS OF USE OF THE PRODUCT, INCONVENIENCE, LOSS OR ANY OTHER DAMAGES, DIRECT OR CONSEQUENTIAL, ARISING OUT OF THE USE OF OR INABILITY TO USE, THIS PRODUCT OR FOR ANY BREACH OF ANY EXPRESS OR IMPLIED WARRANTY, INCLUDING THE IMPLIED WARRANTY OF MERCHANTABILITY APPLICABLE TO THIS PRODUCT.

Some States do not allow the exclusion or limitation of incidental or consequential damages or limitations on how long an implied warranty lasts; so these limitations or exclusions may not apply to you. This warranty gives you specific legal rights and you may also have other rights which vary from state to state.

### THE ABOVE WARRANTY DOES NOT APPLY TO:

1. Service trips to your home to deliver and pickup, install, instruct, or replace house fuses or correct house wiring or plumbing, or correction of unauthorized repairs.
2. Damage to the product caused by accident, pests, fire, floods, or acts of God.
3. Repairs when your LG product is used in other than normal, single-family household use.
4. Damage resulting from accident, alteration, misuse, abuse, or improper installation.
5. Damages caused during and/or after delivery
6. Display, discount, or refurbished units purchased with scratches, dents, or defects.

Proof of purchase is required and must be provided to LG in order to validate warranty.

**Therefore, these costs are paid by the consumer.**

If the product is installed outside the normal service area, any cost of transportation involved in the repair of the product, or the replacement of defective parts, shall be borne by the owner.

### CUSTOMER ASSISTANCE NUMBERS:

**To obtain Warranty Coverage:**

**Retain your Bill of Sale to prove date of purchase.**

A Copy of your Sales Receipt must be submitted at the time warranty service is provided.

**To obtain Product or Customer**

**Call 1-800-243-0000**

(24 hrs a day, 7 days per week, 365 days per year)

**Service Assistance:**

Press the appropriate menu option, and have your product type (Refrigerator), model number, serial number, and ZIP/Postal Code ready.

**To obtain the nearest  
Authorized Service Center:**

**Call 1-800-243-0000**

(24 hrs a day, 7 days per week, 365 days per year)

Press the appropriate option, and have your product type (Refrigerator), model number, serial number, and ZIP/Postal Code ready.



**LG Electronics Inc.**

---

<http://www.lge.com>

P/N: MFL48163801