

This Owner's Manual is provided and hosted by [Appliance Factory Parts](#).



WHIRLPOOL MH6150XLB Owner's Manual

[Shop genuine replacement parts for WHIRLPOOL
MH6150XLB](#)



[Find Your WHIRLPOOL Microwave Parts - Select From 1350 Models](#)

----- Manual continues below -----

EXPLODED VIEW

DOOR PARTS

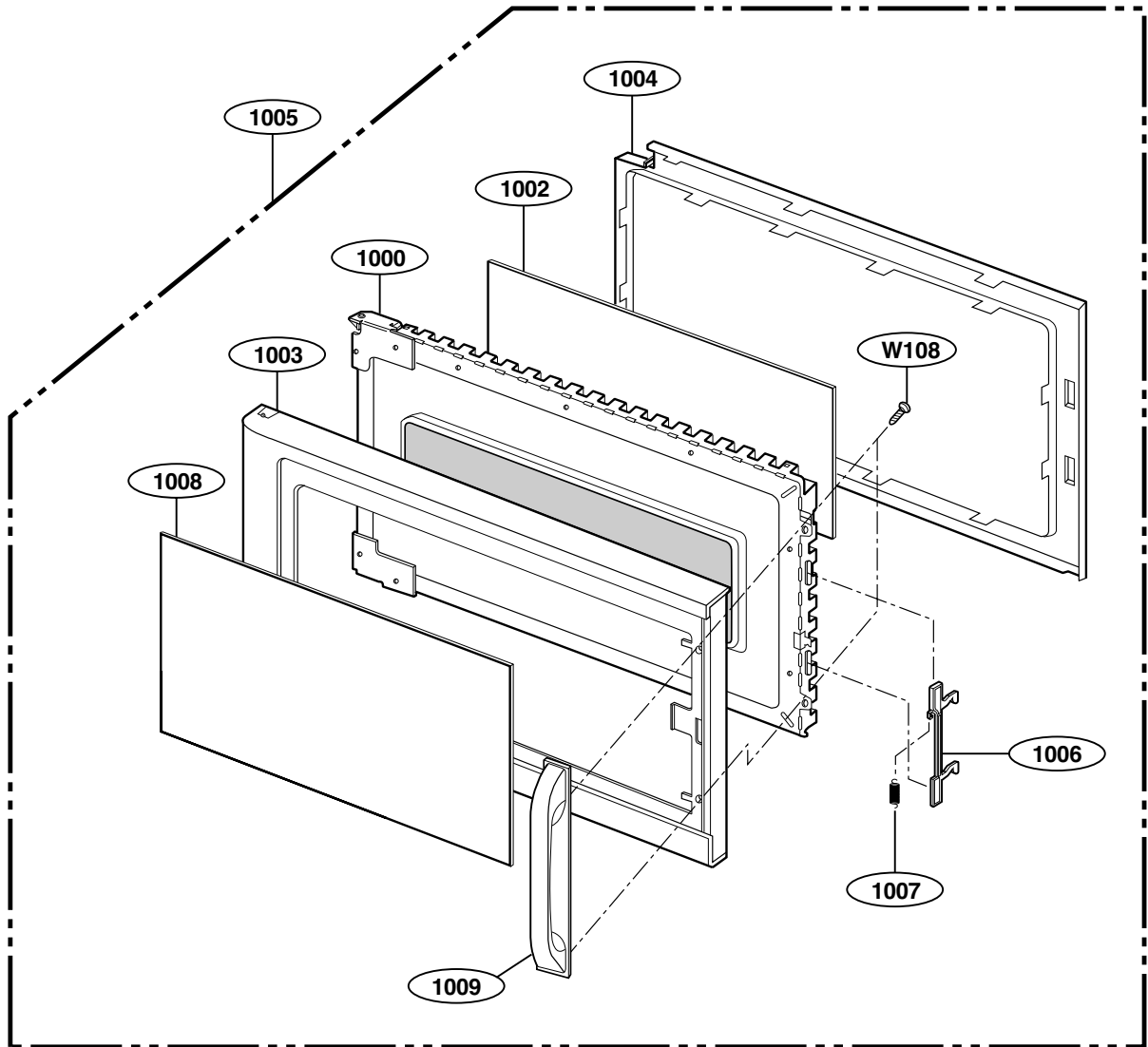

CONTROLLER PARTS

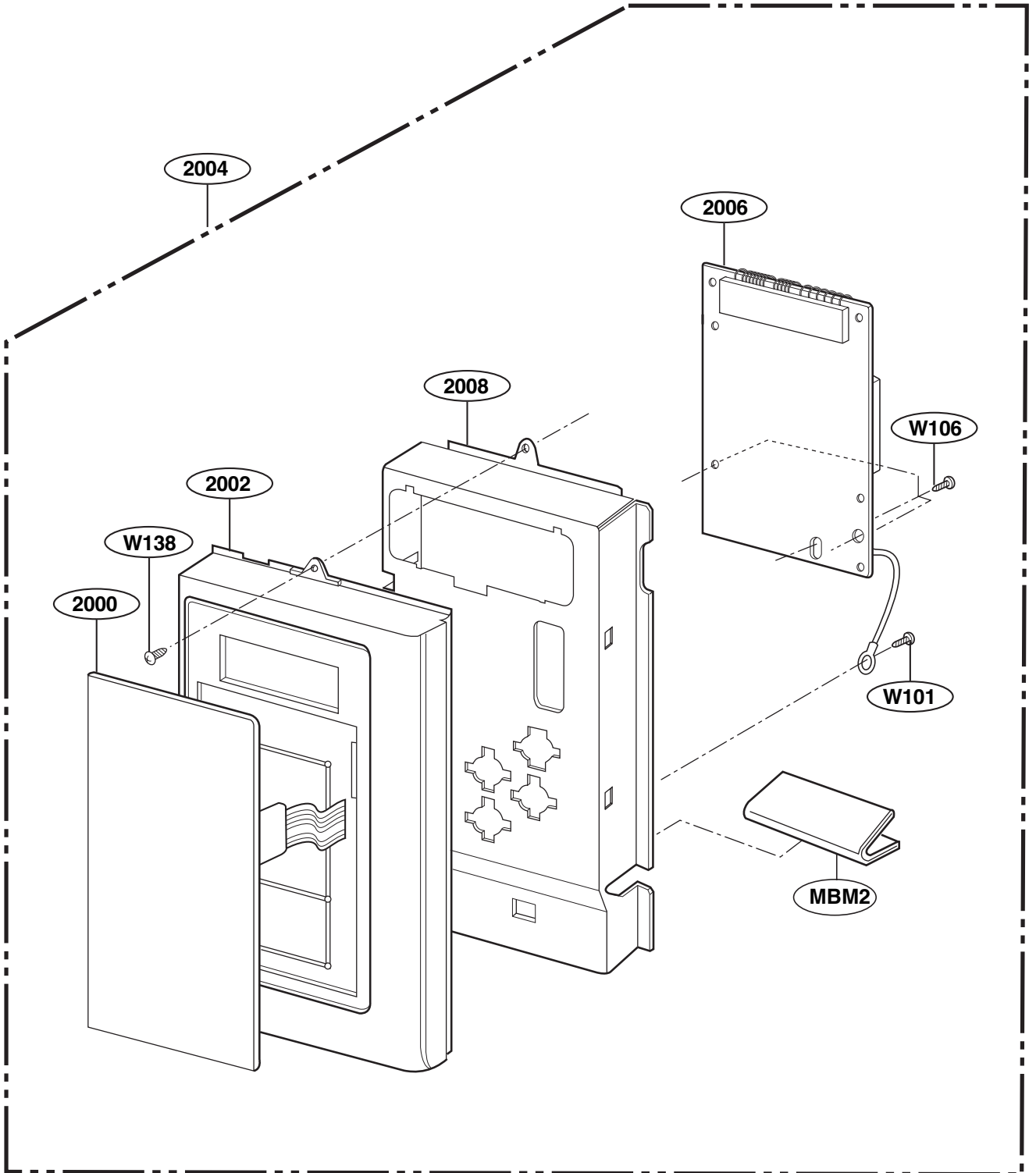

OVEN CAVITY PARTS

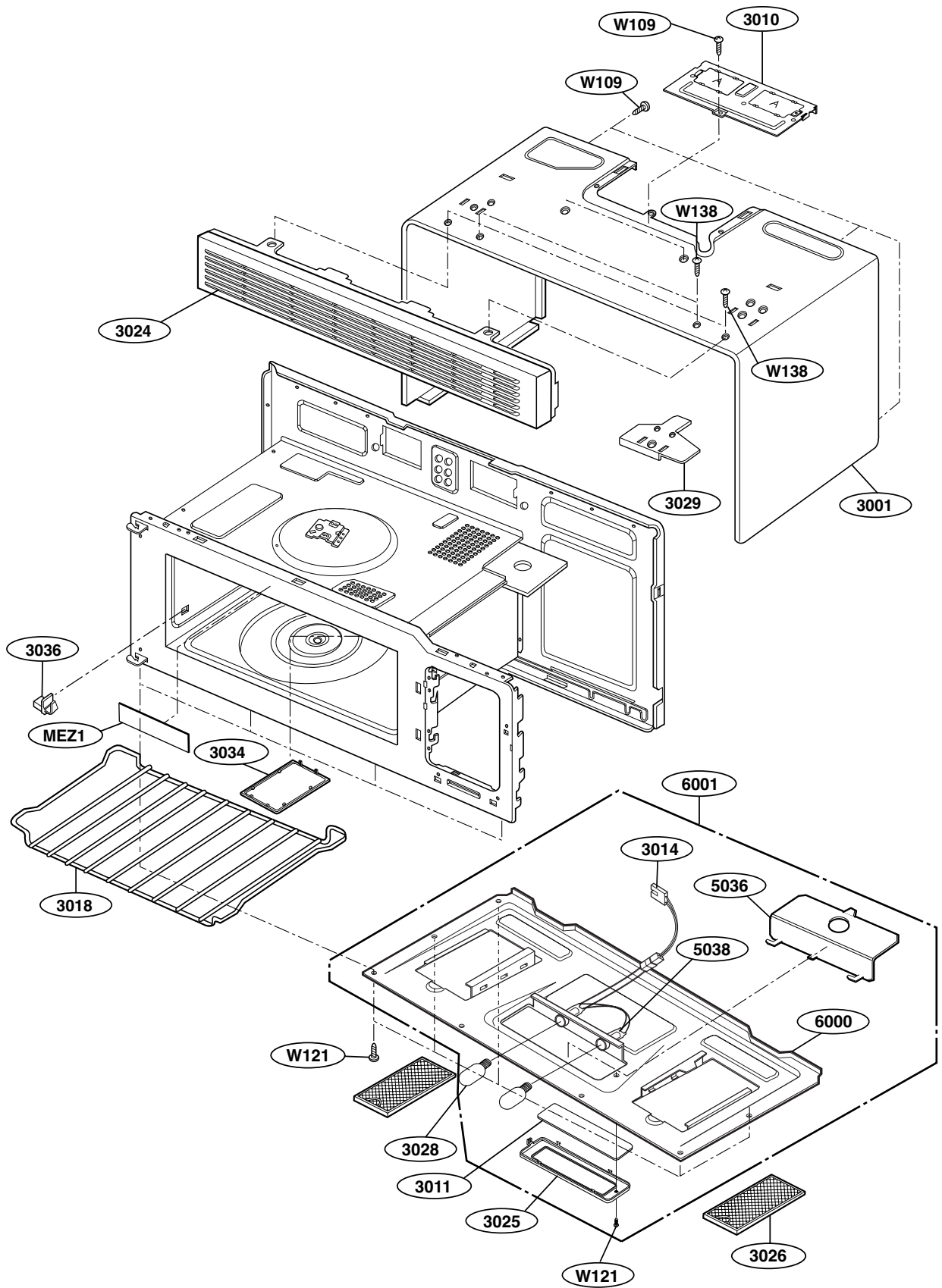

LATCH BOARD PARTS

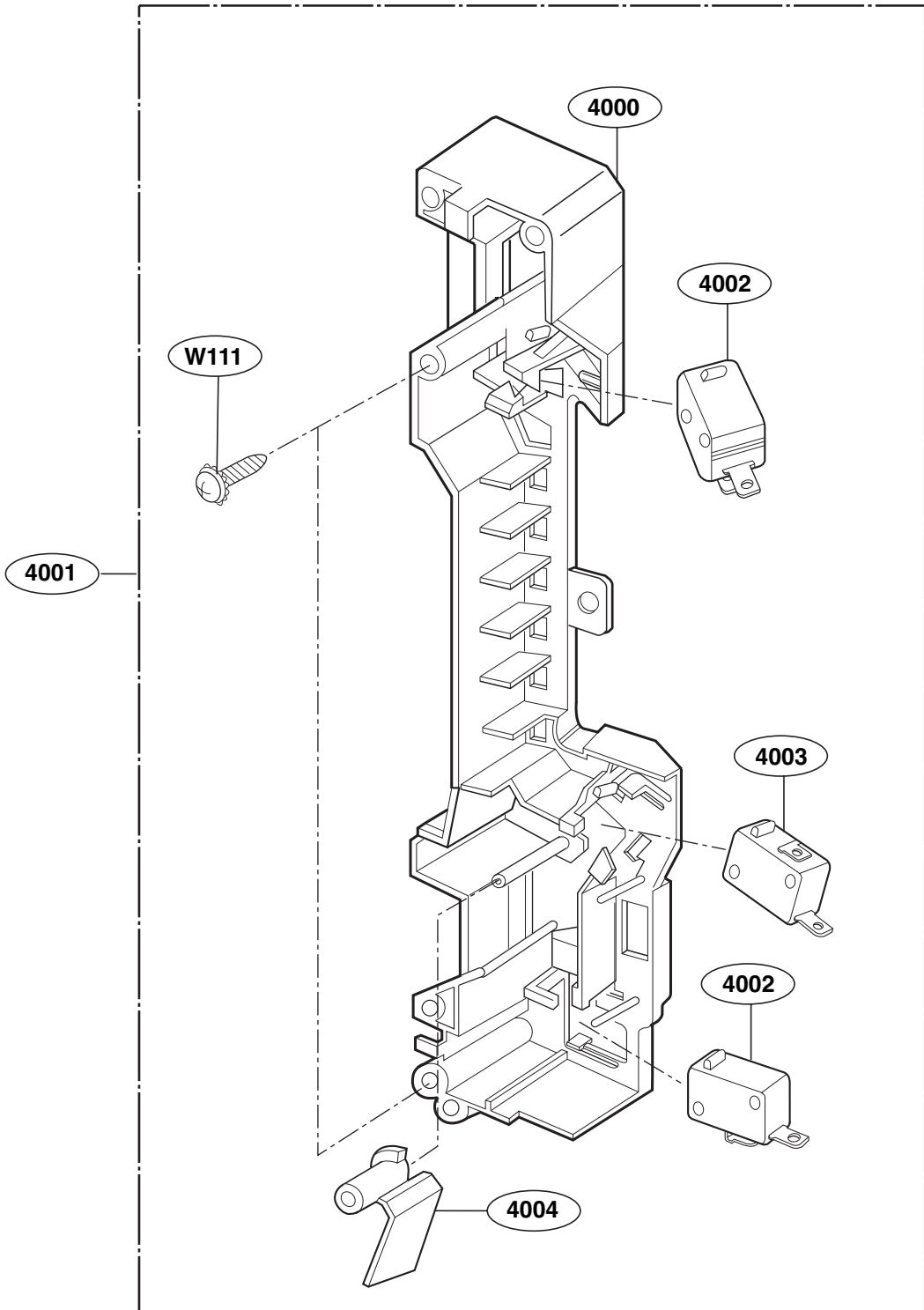

INTERIOR PARTS (I)

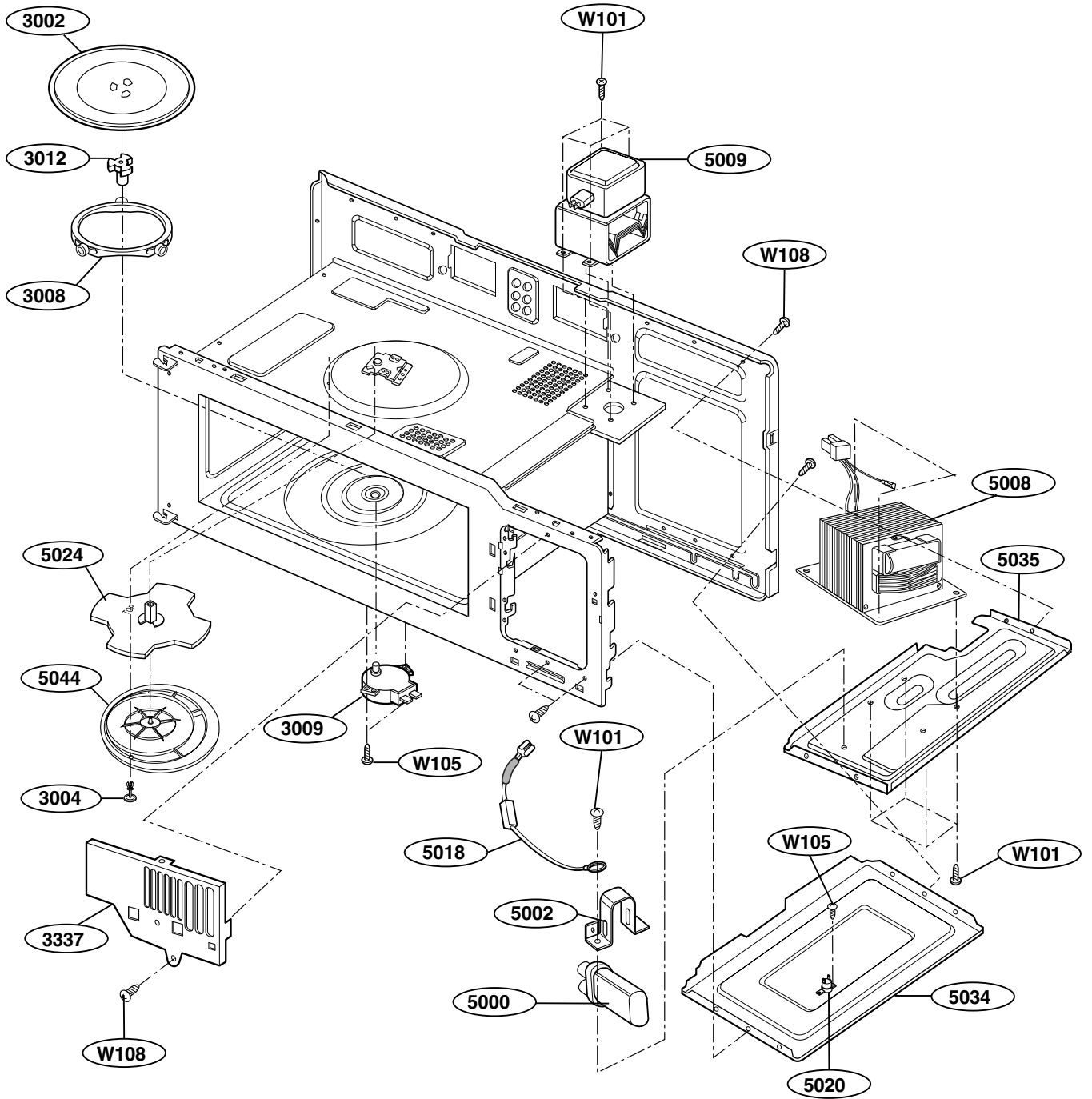

INTERIOR PARTS (II)

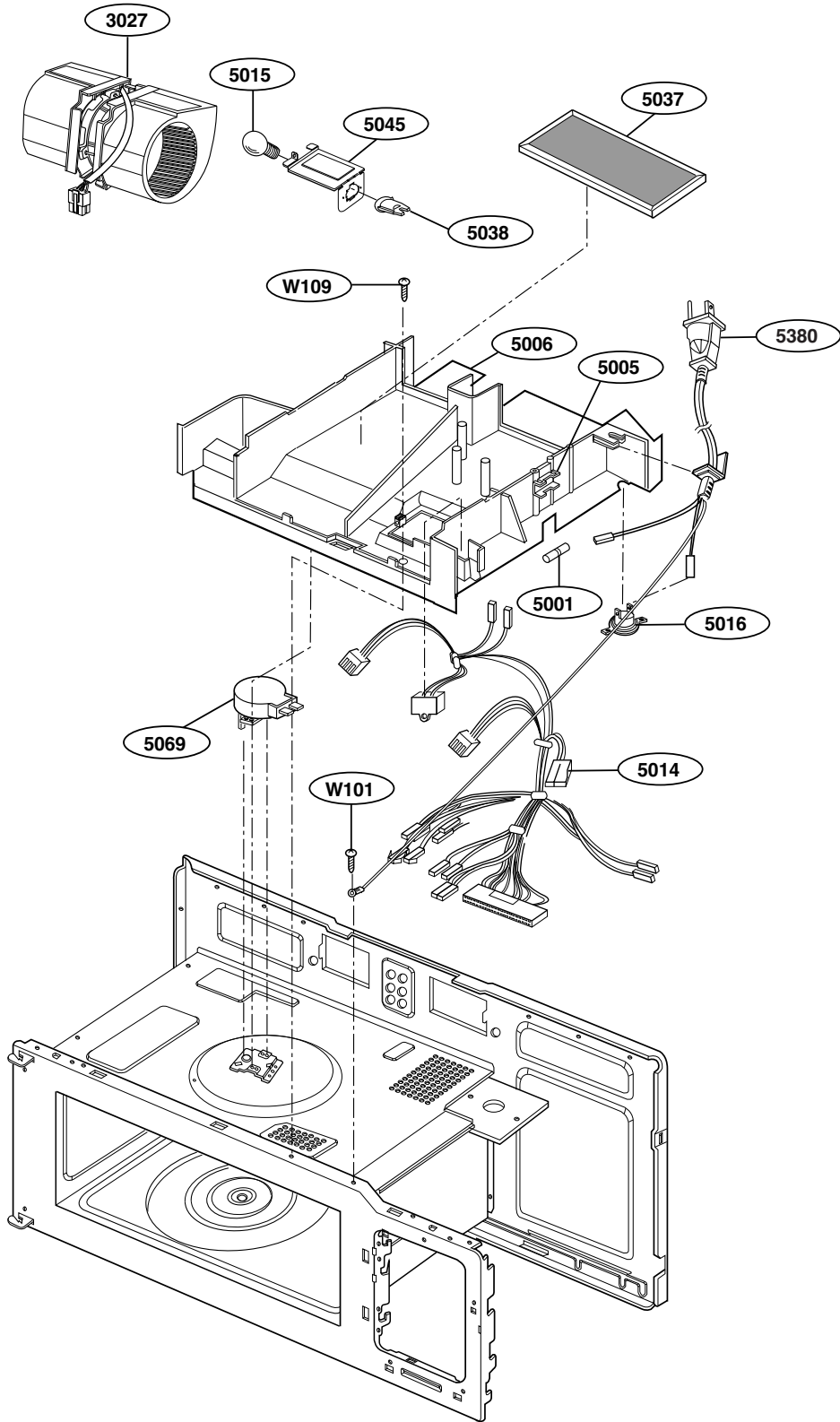

INSTALLATION PARTS

