

This Owner's Manual is provided and hosted by [Appliance Factory Parts](#).



HAMILTON BEACH 33144 Owner's Manual

[Shop genuine replacement parts for HAMILTON
BEACH 33144](#)



[Find Your HAMILTON BEACH Small Appliance Parts - Select From 252 Models](#)

----- Manual continues below -----

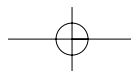

READ BEFORE USE
LIRE AVANT D'UTILISER
LEA ANTES DE USAR

Visit hamiltonbeach.com for delicious recipes, tips, and to register your product online!



Consulter hamiltonbeach.ca pour les recettes délicieuses, conseils pratiques, et pour enregistrer votre produit!

Visite hamiltonbeach.com.mx para recetas deliciosas, consejos, y para registrar su producto en línea.

Questions?

Please call us – our friendly associates are ready to help.
USA: 1.800.851.8900

Questions?

N'hésitez pas à nous appeler – nos associés s'empreseront de vous aider.
CAN: 1.800.267.2826

¿Preguntas?

Por favor llámenos – nuestros amables representantes están listos para ayudar.
MEX: 01 800 71 16 100

Le invitamos a leer cuidadosamente este instructivo antes de usar su aparato.

Hamilton
E

Stay or Go™ Slow
Mijoteuse Slow
Olla de cocción Slow



English
Français
Español

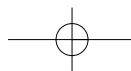

IMPORTANT SAFEGUARDS

When using electrical appliances, basic safety precautions should always be followed to reduce the risk of fire, electric shock, or injury to persons, including the following:

1. Read all instructions.
2. Do not touch hot surfaces. Use handles or knobs.
3. To protect against electrical shock do not immerse cord, plug, or base in water or other liquid.
4. Close supervision is necessary when any appliance is used by or near children.
5. Unplug from outlet when not in use and before cleaning. Allow to cool before putting on or taking off parts.
6. Do not operate any appliance with a damaged cord or plug, or after the appliance malfunctions or is dropped or damaged in any manner. Call our toll-free customer service number for information on examination, repair, or adjustment.
7. The use of accessory attachments not recommended by the appliance manufacturer may cause injuries.
8. Do not use outdoors.
9. Do not let cord hang over edge of table or counter surfaces, including stove.
10. Do not place on or near hot gas or an electric burner or heated oven.
11. Extreme caution must be used when moving appliance containing hot oil or other hot liquids.
12. To disconnect slow cooker, turn control knob to OFF and unplug from wall outlet.
13. **CAUTION:** To prevent damage or shock hazard do not touch the heating base. Cook only in removable crock.
14. Avoid sudden temperature changes, such as adding cold foods into a heated crock.
15. Do not use appliance for other than intended uses.

SAVE THESE INSTRUCTIONS!

OTHER CONSUMER SAFETY INFORMATION

This product is intended for household use only.

This product is only intended for the preparation, cooking, and serving of foods. This product is not intended for use with any non-food materials or products.

WARNING! Shock Hazard: This appliance has a polarized plug (one wide blade) that reduces the risk of electric shock. The plug fits only one way into a polarized outlet. Do not defeat the safety purpose of the plug by modifying the plug in any way or using an adaptor. If the plug does not fit, reverse the plug. If it still does not fit, have an electrician replace the outlet.

The length of the cord used on this appliance was chosen to minimize the hazards of becoming tangled in, or tripping over, the cord. If a longer cord is necessary an approved extension cord must be used. The electrical rating of the extension cord must be equal to or greater than the rating of the appliance. Care must be taken to arrange the extension cord so that it will not drape over the top or tabletop where it can be pulled on by children or tripped over.

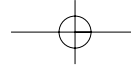

LID AND CROCK: PRECAUTIONS AND INFORMATION

- Please handle crock and lid carefully to ensure long life.
- Avoid sudden, extreme temperature changes. For example, do not place a hot lid or crock into cold water, or onto a wet surface.
- Avoid hitting crock or lid against faucet or other hard surfaces.
- Do not use crock or lid if chipped, cracked, or severely scratched.
- Do not use abrasive cleansers or metal scouring pads.
- The bottom of crock is very rough and can damage other surfaces. Use caution.
- The crock and lid can become very hot. Use caution when touching directly on any unprotected surface or countertop.
- The crock is microwave safe and oven proof, but do not use when empty. Never place lid on a burner or stove. Do not place lid in a microwave oven, conventional oven, or toaster oven.

REMOVING LID AND CROCK

When removing lid, tilt so that opening faces away from you to avoid being burned by steam.

The sides of the slow cooker's base get very warm when heating elements are located here. Use handles on the sides. Use hot mitts to remove crock.

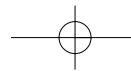
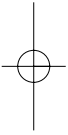

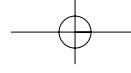

Parts and Features

Crock Capacity

For best results, fill the crock at least half-full but no more than one in. If only half-filled, check for doneness 1 to 2 hours earlier than recipe.

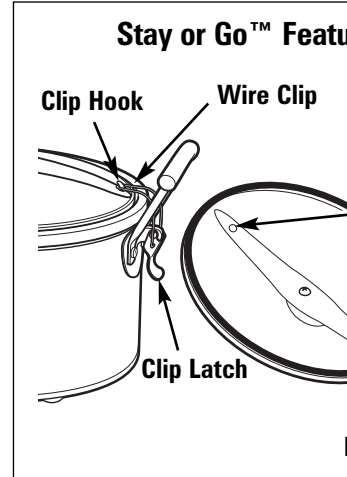
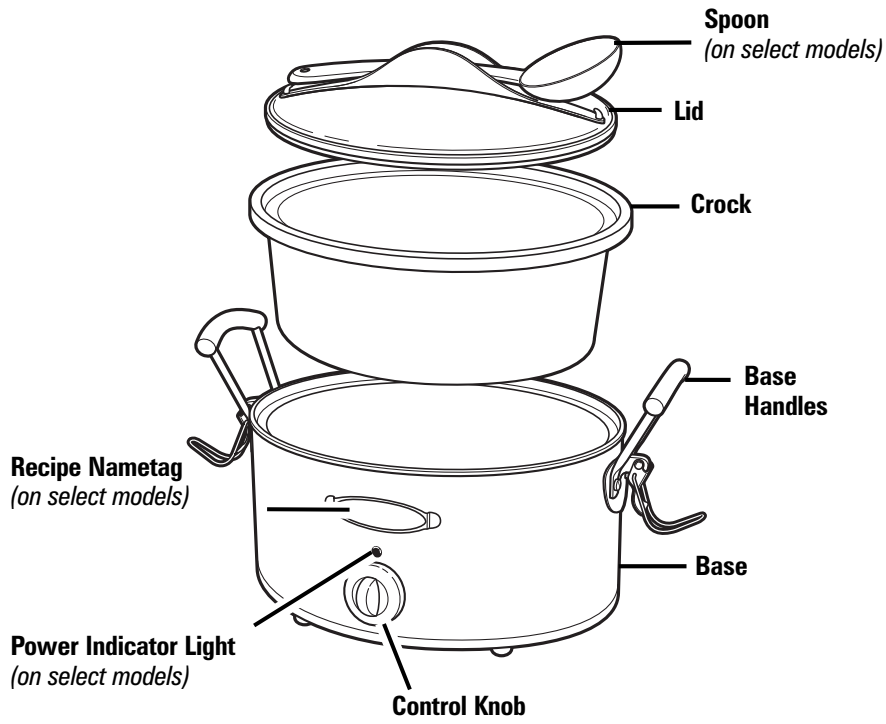

On select models

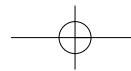
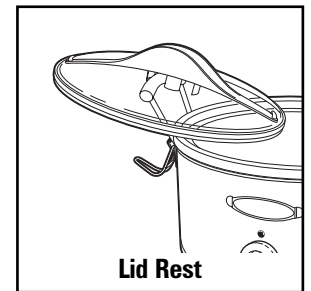

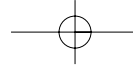

How to Use Your Slow Cooker

Before First Use: Wash lid and crock in hot, soapy water. Rinse and dry.

⚠ WARNING Food Safety Hazard. Food may prevent bacterial growth before using Keep Warm. Keep Warm setting should only be used after food is thoroughly cooked. Do not reheat food on Keep Warm if food has been cooked and then refrigerated. Cook on High, then switch to Keep Warm. Visit [foodsafety.gov](#) for more information.

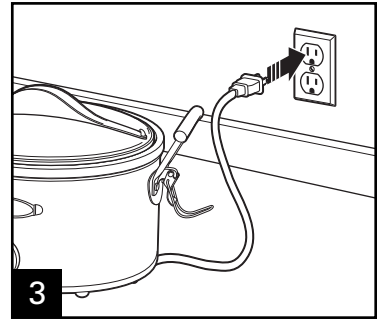
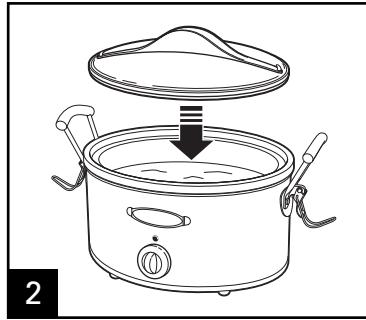
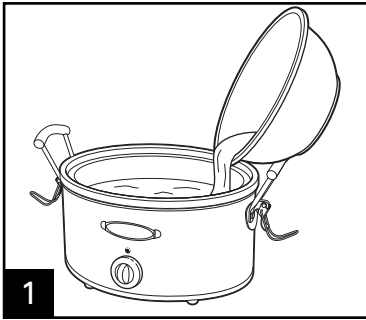

Wattage has been adjusted to compensate for heat lost through vent holes.

Rotate control knob to OFF. Do not cook on OFF.

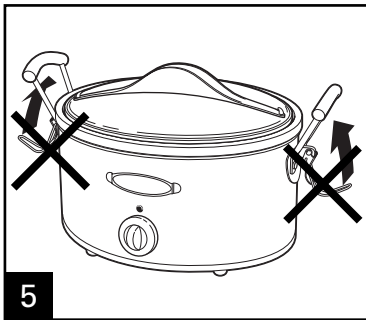

NEVER lock clips during cooking.

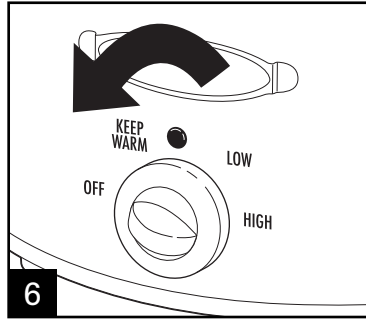

When finished, turn OFF.

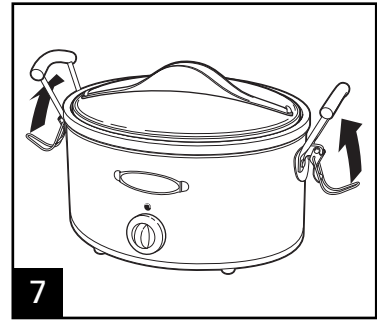

Secure wire clips for transport.

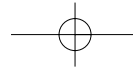
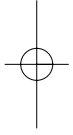

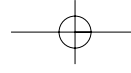

Cleaning and Care

⚠ WARNING

Electrical Shock Hazard.

Disconnect power before cleaning. Do not immerse crock or base in any liquid.

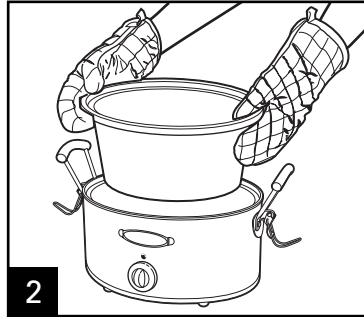
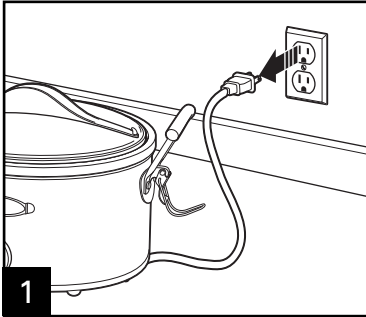

Remove crock and let cool.

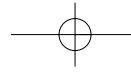
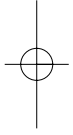
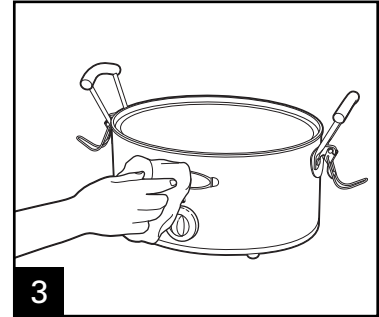

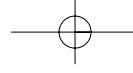

Tips for Slow Cooking

- The crock should be at least half-filled for best results. If only half-filled, check for doneness 1 to 2 hours earlier than recipe.
- Stirring is not necessary when slow cooking and removing glass lid results in major heat loss and the cooking time may need to be extended. However, if cooking on High, you may want to stir occasionally.
- If cooking soups or stews, leave a 2-inch (5 cm) space between the top of the crock and the food so that the recipe can come to a simmer.
- Many recipes call for cooking all day. If your morning schedule doesn't allow time to prepare a recipe, do it the night before. Place all ingredients in crock, cover with lid and refrigerate overnight. In the morning, simply place crock in slow cooker.
- Do not use frozen, uncooked meat in slow cooker or poultry before slow cooking.
- Some foods are not suited for extended cooking. Pasta, seafood, milk, cream, or sour cream should be added before serving. Evaporated milk or condensed soups are best for slow cooking.
- The higher the fat content of meat, the less liquid is needed. For meat with a high fat content, place thick onion slices on top of meat will not sit on (and cook in) fat.
- Slow cookers allow for very little evaporation. If making soup, stew, or sauce, reduce liquid called for in recipe. If thick, liquid can be added later.
- If cooking a vegetable-type casserole, there will need to be extra liquid in the recipe to prevent scorching on the sides of crock.

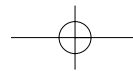
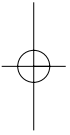

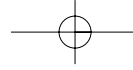

Cooking Chart

Visit hamiltonbeach.com for more tips, and to register your product online.

For best results, fill the crock at least half-full but no more than one inch from rim. Always follow package directions.

RECIPE	INGREDIENTS 3-5 QT/L SIZE SLOW COOKER	INGREDIENTS 6-7 QT/L SIZE SLOW COOKER	INSTRUCTIONS
Beef Pot Roast	2 lb. (907 g) beef pot roast 1 teaspoon (5 ml) salt 1/2 teaspoon (2.5 ml) pepper 1/4 (60 ml) cup beef broth 1/2 to 1 envelope dry onion mix 1 onion, quartered 2 potatoes, quartered 2 carrots, cut in 1" (2.5 cm) pieces	3-5 lb. (1.3-2.2 kg) beef pot roast 1-1/2 teaspoons (7.5 ml) salt 1 teaspoon pepper (5 ml) 1/2 cup (125 ml) beef broth 1 envelope dry onion mix 2 onions, quartered 3-4 potatoes, quartered 3-4 carrots, cut in 1" (2.5 cm) pieces	<ol style="list-style-type: none"> Season roast with salt and pepper. Over medium-high heat, brown roast. Place vegetables in crock. Place roast on top of vegetables. Sprinkle with onion soup mix. Drizzle beef broth over meat and vegetables. Cover and cook on HIGH for 5 hours or until internal temperature is at least 160°F (71°C) for medium. LOW setting will result in more tender meat.
Chili	1 lb. (450 g) ground beef 1 1.5 oz (40 g) envelope chili seasoning 1 14.5 oz. (411 g) can diced tomatoes 1 16 oz. (453 g) can kidney beans, (drained and rinsed)	2 lb. (907 g) ground beef 2 1.5 oz (40 g) envelopes chili seasoning 2 14.5 oz. (411 g) can diced tomatoes 2 16 oz. (453 g) can kidney beans, (drained and rinsed)	<ol style="list-style-type: none"> Combine beef, chili seasoning, and kidney beans in crock. Cover and cook on HIGH for 4 hours or until temperature is at least 160°F (71°C).
Whole Chicken	3 lb. (1.3 kg) whole chicken 2 garlic cloves, peeled 1/2 lemon 1 bay leaf 1 teaspoon (5 ml) salt 1/2 teaspoon (2.5 ml) pepper 1 teaspoon (5 ml) paprika	4-6 lb (1.8-2.7 kg) whole chicken (or two 3 lb. [1.3 kg] chickens) 3 garlic cloves, peeled 1/2 lemon 2 bay leaves 2 teaspoons (10 ml) salt 1 teaspoon (5 ml) pepper 1-2 teaspoons (5-10 ml) paprika	<ol style="list-style-type: none"> Remove giblets/neck from cavity. Place garlic, lemon and bay leaves in cavity. Season chicken(s) with salt and pepper. Place chicken(s) in crock and cover. Cover and cook on HIGH for 4 hours or until internal temperature is at least 165°F (74°C).

Visit www.foodsafety.gov for more information on safe internal cooking temperatures.

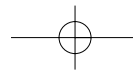

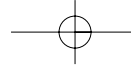

Troubleshooting

POTENTIAL PROBLEM

PROBABLE CAUSE

Food is undercooked.

- Was food cooked on the Keep Warm setting? Do not cook on Keep Warm; always cook on High heat settings.
- Was power interrupted?
- Did you select the Low heat setting, but use a cooking time based on the High heat setting?
- Did you have the lid placed correctly on the slow cooker?

The food isn't done after cooking the amount of time recommended in my recipe.

- This can be due to voltage variations (which are commonplace everywhere) or altitude. Fluctuations in power do not have a noticeable effect on most appliances. However, it can affect cooking times in the slow cooker by extending the cooking times. Allow sufficient time at the appropriate heat setting. You will learn through experience if a shorter or longer time is appropriate.

My meal was overcooked. Why?

- Was the crock at least half-full? The slow cooker has been designed to thoroughly cook a full crock. If the crock is only half-filled, check for doneness 1 to 2 hours earlier than recipe recommends.
- Did you select correct number of hours based on cooking temperature (Low or High)?
- Foods will continue to increase in temperature after desired temperature has been reached.

Lid gasket collapsed.

- This can be caused by sudden temperature change, like running cold water over a warm lid. Allow lid to sit at room temperature. It will return to its original shape within 24 hours.
- To help maintain shape of gasket, do not cook with clips latched and do not store empty crock with clips latched.

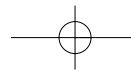
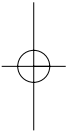

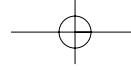

Limited Warranty

This warranty applies to products purchased in the U.S. or Canada.

This product is warranted to be free from defects in material and workmanship for a period of one (1) year from the date of purchase, except as noted below. During this period, we will repair or replace this product at our option. THE FOREGOING WARRANTY IS THE ONLY WARRANTY, AND NOT ANY OTHER WARRANTY OR CONDITION, WHETHER EXPRESS OR IMPLIED, WRITTEN OR ORAL INCLUDING, WITHOUT LIMITATION, ANY STATUTORY WARRANTY OR CONDITION OF MERCHANTABILITY OR FITNESS FOR A PARTICULAR PURPOSE. ANY LIABILITY FOR CONSEQUENTIAL DAMAGES IS EXPRESSLY LIMITED TO AN AMOUNT EQUAL TO THE PURCHASE PRICE PAID, AND ALL CLAIMS FOR SPECIAL, INCIDENTAL OR CONSEQUENTIAL DAMAGES ARE HEREBY EXCLUDED. There is no warranty with respect to the following, which may be supplied with the product, including without limitation: glass parts, glass containers, cutter/strainers, blades, seals, gaskets, clutches, motor brushes, agitators, etc. This warranty extends only to the original consumer purchaser and does not cover a defect resulting from abuse or neglect including failure to clean product regularly in accordance with manufacturer's instructions, use for commercial purposes, or use not in conformity with the printed directions. This warranty gives you specific legal rights, and you may also have other legal rights that vary from state to state, or province to province. Some states or provinces do not allow limitations on implied warranties or special consequential damages, so the foregoing limitations may not apply to you.

If you have a claim under this warranty, DO NOT RETURN THE APPLIANCE TO THE STORE! Please call our CUSTOMER SERVICE at 1.800.851.8900 (For faster service please have model, series, and type numbers ready for operator to assist you.)

CUSTOMER SERVICE NUMBERS

In the U.S. 1.800.851.8900

In Canada 1.800.267.2826

In Mexico 01.800.71.16.100

hamiltonbeach.com

KEEP THESE NUMBERS FOR FUTURE REFERENCE!

