

This Owner's Manual is provided and hosted by [Appliance Factory Parts](#).



HAMILTON BEACH 33956 Owner's Manual

[Shop genuine replacement parts for HAMILTON
BEACH 33956](#)



[Find Your HAMILTON BEACH Small Appliance Parts - Select From 252 Models](#)

----- Manual continues below -----

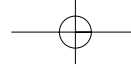

READ BEFORE USE
LIRE AVANT D'UTILISER
LEA ANTES DE USAR

Visit hamiltonbeach.com for
delicious recipes and to register
your product online!



Consulter hamiltonbeach.ca pour les
recettes délicieuses et pour enregistrer
votre produit!

Visite hamiltonbeach.com.mx para
recetas deliciosas y para registrar
su producto en línea.

Questions?
Please call us – our friendly
associates are ready to help.

USA: 1.800.851.8900

CAN: 1.800.267.2826

MEX: 01 800 71 16 100

*Le invitamos a leer cuidadosamente
este instructivo antes de usar su
aparato.*

Ham

Programmable Slow

Mijoteuse pr

Olla de cocción lenta



Engl
Fran
Espa

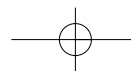

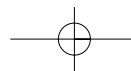

IMPORTANT SAFEGUARDS

When using electrical appliances, basic safety precautions should always be followed to reduce the risk of fire, electrical injury to persons, including the following:

1. Read all instructions.
2. Do not touch hot surfaces. Use handles or knobs.
3. To protect against electrical shock do not immerse cord, plug, or base in water or other liquid.
4. Close supervision is necessary when any appliance is used by or near children.
5. Unplug from outlet when not in use and before cleaning. Allow to cool before putting on or taking off parts.
6. Do not operate any appliance with a damaged cord or plug, or after the appliance malfunctions or is dropped or damaged in any manner. Call our toll-free customer service number for information on examination, repair, or adjustment.
7. The use of accessory attachments not recommended by appliance manufacturer may cause injuries.
8. Do not use outdoors.
9. Do not let cord hang over edge of table or over hot surfaces, including stove.
10. Do not place on or near hot gas or an electric heated oven.
11. Extreme caution must be used when moving containing hot oil or other hot liquids.
12. To disconnect slow cooker, press OFF button and remove plug from wall outlet.
13. Caution: To prevent damage or shock hazard, do not touch base. Cook only in removable liner.
14. Avoid sudden temperature changes, such as adding cold foods into a heated crock.
15. Do not use appliance for other than intended purposes.

SAVE THESE INSTRUCTIONS!

OTHER CONSUMER SAFETY INFORMATION

This product is intended for household use only.

This product is only intended for the preparation, cooking, and serving of foods. This product is not intended for use with any non-food materials or products.

WARNING! Shock Hazard: This appliance has a polarized plug (one wide blade) that reduces the risk of electric shock. The plug fits only one way into a polarized outlet. Do not defeat the safety purpose of the plug by modifying the plug in any way or using an adaptor. If the plug does not fit, reverse the plug. If it still does not fit, have an electrician replace the outlet.

2

The length of the cord used on this appliance should be used to reduce the hazards of becoming tangled in, or tripped over, a longer cord. If a longer cord is necessary an extension cord may be used. The electrical rating of the extension cord must be equal to or greater than the rating of the appliance. Care must be taken to arrange the extension cord not drape over the countertop or tabletop where it can be pulled on by children or accidentally tripped over.

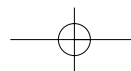

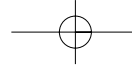

Parts and Features

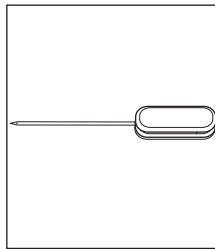
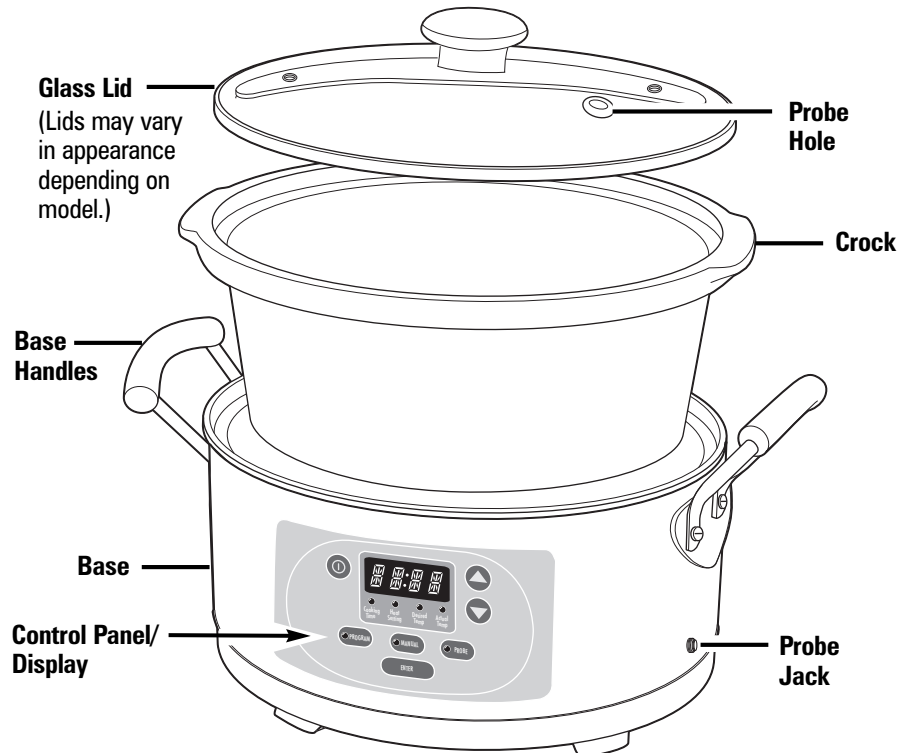

Probe
(available on some models)

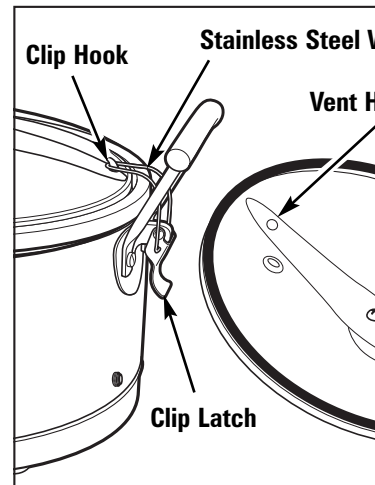

Travel Features
(available on some models)

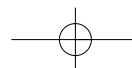
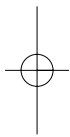

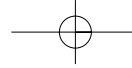

Cooking Modes

No matter what you plan to cook, the Set 'N Forget® Slow Cooker has three cooking modes to make it easy. Here's how to choose the one that's right for your lifestyle and the food you're cooking.

Will you be away when your food is finished cooking?

Use PROGRAM Mode. Input preferred amount of cooking time and the slow cooker automatically shifts to Warm at the end of the selected cooking time. Food won't overcook!

Do you want to cook the traditional way without setting a time?

— OR —

Do you want to heat previously cooked food?

Use MANUAL Mode. Lets you select traditional High or Low settings.

Are you cooking a large cut of meat or using a recipe that requires food to reach a certain temperature?

Use PROBE Mode. For many foods, especially large cuts of meat like roasts, chicken, turkey and pork, internal food temperature is the best test for doneness. The temperature probe with this slow cooker takes the guesswork out of slow cooking. Select the desired internal food temperature and the slow cooker will automatically shift to Warm once the temperature is reached. By using the *Cooking Guide for Probe* chart, you can estimate the amount of time the food will need to cook.

Visit foodsafety.gov for more information about cooking times and proper internal temperature settings.

Do you want to keep previously cooked food warm?
(For instance, moving slow cooker from kitchen to dining room.)

Use the PROBE Mode. Once food reaches desired temperature, you can select the Warm setting to monitor food.

Use the MANUAL Mode. Lets you select Warm setting.

Use the PROGRAM Mode. Lets you select Warm setting. The slow cooker will shut off after desired time.

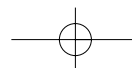
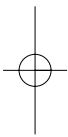

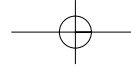

Program Mode

⚠ WARNING To reduce the risk of electrical shock, do not immerse base. Before First Use: Wash glass lid and crock in hot, soapy water. Rinse and dry.

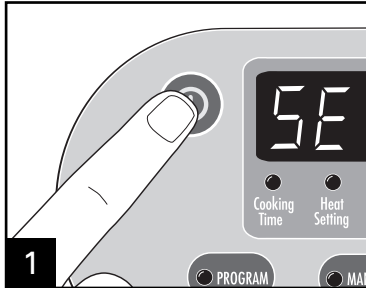

1 Press **ON**.

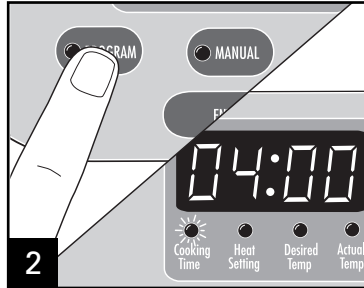

2 Press **PROGRAM**. Cooking Time will illuminate.

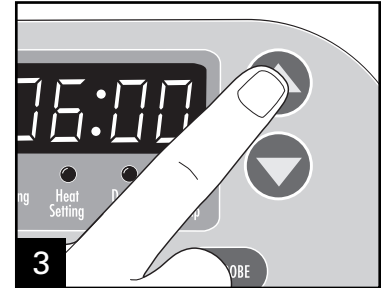

3 Press arrows to select cooking time.

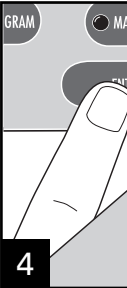

4 Press **ENTER**. The display will illuminate.

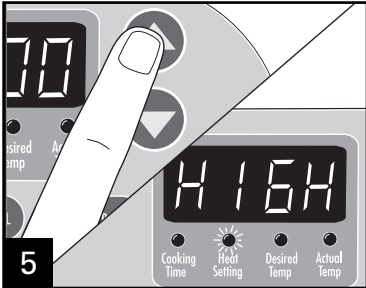

5 Press arrows to select heat setting.
NOTE: Do not use Warm setting to cook food.

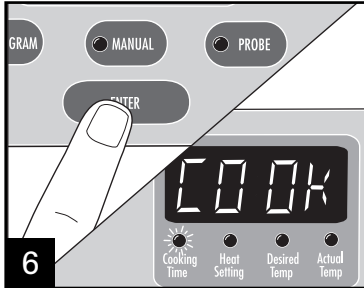

6 Press **ENTER** to start unit and a 3 second beep will sound.
NOTE: Unit will automatically start in 20 seconds if **ENTER** is not pressed.

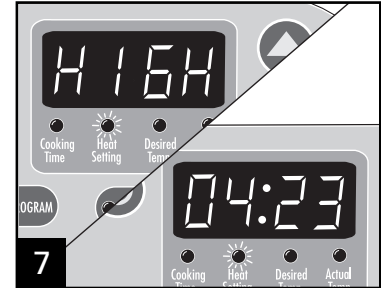

7 Display will alternate between heat setting and remaining time.



8 At the end of cooking, the unit will turn off and display will show 'W' (Warm) for 14 hours.
NOTE: If Warm setting is selected, the unit will turn OFF after 14 hours.

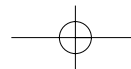
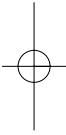

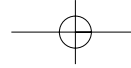

Manual Mode

⚠ WARNING To reduce the risk of electrical shock, do not immerse base. Before First Use: Wash glass lid and crock in hot, soapy water. Rinse and

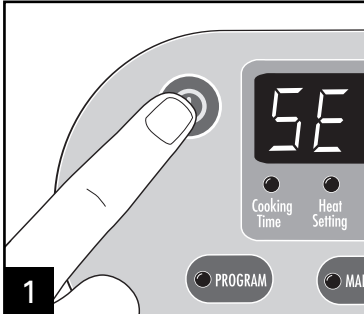

1 Press **ON**.

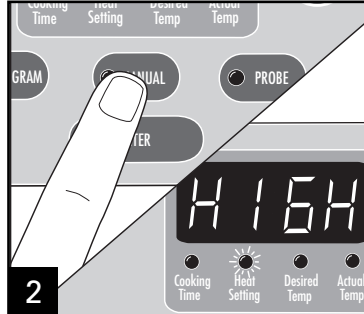

2 Press **MANUAL**. Heat setting will illuminate.

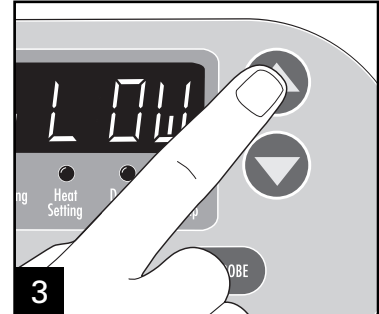

3 Press arrows to select heat setting. **NOTE:** Do not use Warm setting to cook food.

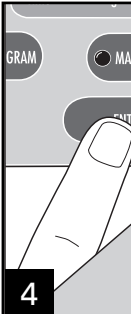

4 Press **ENTER**. A beep will sound. **NOTE:** Unit will turn off in 20 seconds if no button is pressed.

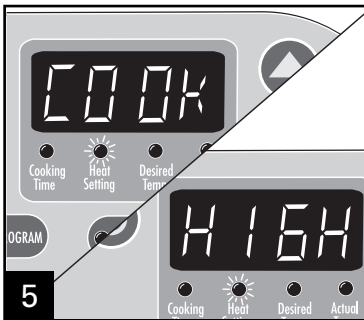

5 The display will alternate between **COOK** and heat setting (if **HIGH** or **LOW** is selected). If using **Warm** setting, display will remain on **WARM**.

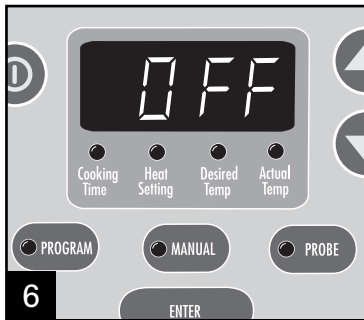

6 The unit will turn off and display **OFF** after a total of 14 hours.

6

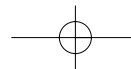
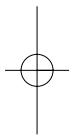

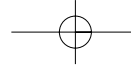

Probe Mode

⚠ WARNING To reduce the risk of electrical shock, do not immerse base in water.
 Before First Use: Wash glass lid and crock in hot, soapy water. Rinse and dry.

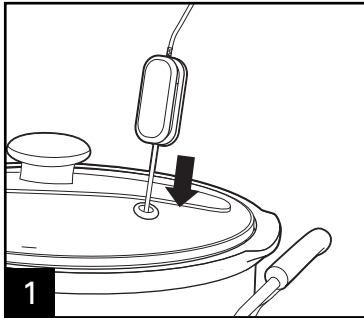

1 Make sure probe is in center of food and not touching bottom of crock.

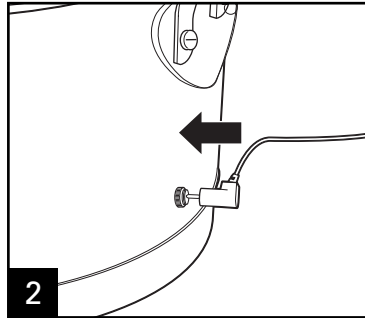

2 Insert probe into jack on side of slow cooker.

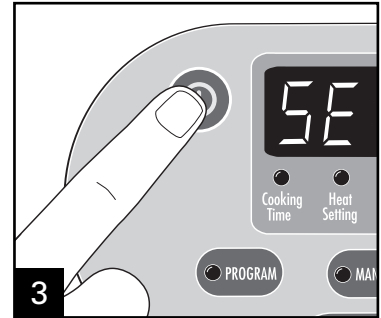

3 Press **ON**.

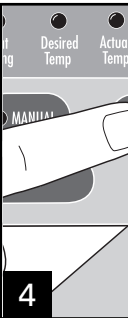

4 Press **PROBE** illuminated.

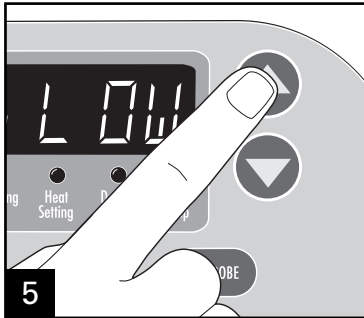

5 Press arrows to select desired heat setting. Select **HIGH** or **LOW**.
NOTE: Do not use Warm setting to cook food.

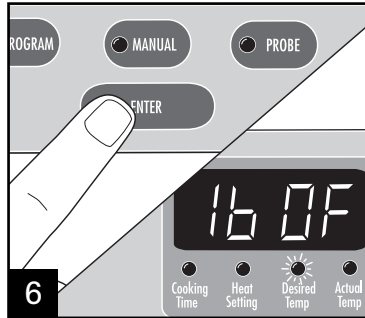

6 Press **ENTER**. Desired Temp will illuminate.

NOTE: To change temperature display from °F to °C:

Press **PROBE** then **ENTER** at the same time.

The temperature in °C will now be displayed.

If slow cooker is unplugged, it will reset to °F.



7 Press arrows to change temperature.

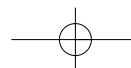

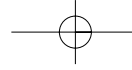

Probe Mode (cont)

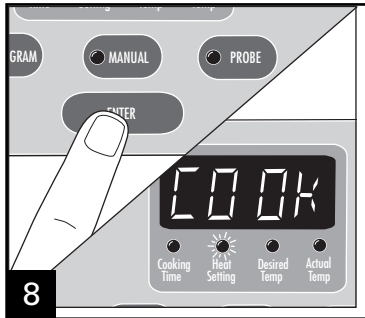

Press **ENTER**. COOK will display and 3 second beep will sound.

NOTE: Unit will automatically start in 20 seconds if **ENTER** is not pressed.

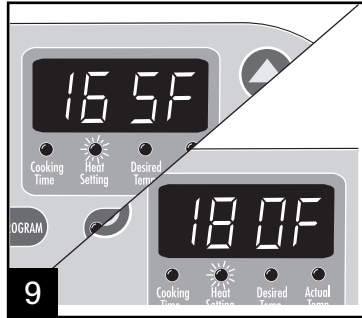

Display will alternate between actual temperature and the temperature selected.

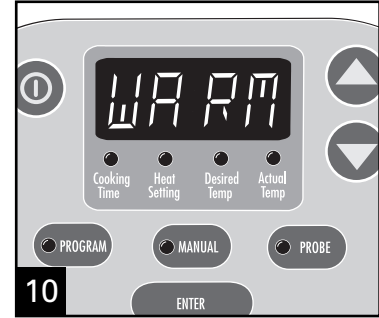

When selected temperature is reached, the unit will switch to Warm and display WARM constantly.



The unit will OFF after a t

To monitor temperature after food is cooked:

1. Press **OFF** (if not already off), then press **ON**.
2. Press **PROBE**. Heat setting will be illuminated.
3. Press arrows to select WARM.
4. Press **ENTER**. WARM will display and 3 second beep will sound.

NOTE: The unit will automatically start in 20 seconds if **ENTER** is not pressed. Display will alternate between WARM and actual temperature. The unit will turn off and display OFF after a total of 14 hours.

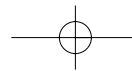

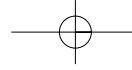

Cooking Guide for Probe

Per USDA food safety guidelines.
Visit foodsafety.gov for more information.

FOOD/WEIGHT	LOW	HIGH	D
Beef Roast (3 lbs/1.5 kg)	3-4 hours	1.5 hours	
Beef Brisket (4-5 lbs/2-2.2 kg)	8 hours	6 hours	
Turkey Breast (6-7 lbs/3-3.5 kg)*	6-7 hours	3-4 hours	
Whole Chicken (4-6 lbs/2-3 kg)	6 hours	4 hours	
Chicken Pieces (bone-in) (3-4 lbs/1.5-2 kg)	4-5 hours	1.5 hours	
Chicken Breasts (4 lbs/2 kg)	4 hours	3.5 hours	
Fully Cooked ham (7.5 lbs/3.5 kg)*	4-5 hours	3 hours	
Pork Tenderloin (2-3 lbs/2-2.2 kg)	2-3 hours	1.5-2 hours	
Pork Roast (4-5 lbs/2-2.2 kg)	4-5 hours	2.5 hours	
Pork Chops (2-3 lbs/1-1.5 kg)	5 hours	2-3 hours	

* For 6-quart slow cooker only. Adjust the size and weight of food to fit 5-quart (or smaller) slow cooker.

NOTE: If cooking dense vegetables (such as potatoes or other root vegetables) with meats, check for done desired meat temperature is reached. These types of vegetables may take longer to cook when cooked with meats such as those listed in the Cooking Guide above.

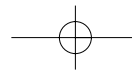

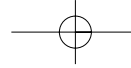

Care and Cleaning

⚠ WARNING

To reduce the risk of electrical shock, do not immerse the base in water.

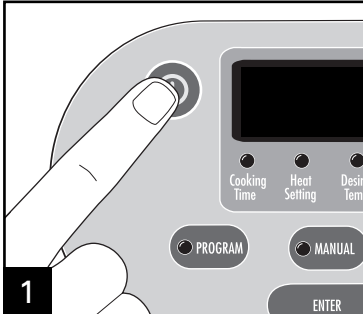

1

Press **OFF**.

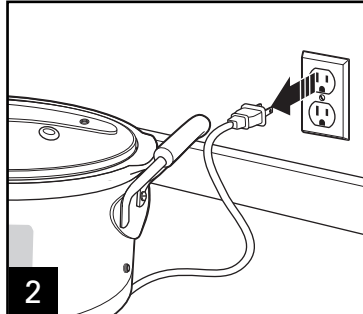

2

Unplug cord from outlet.

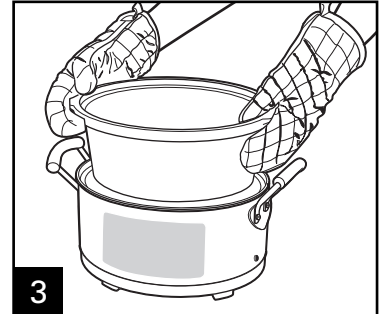

3

Remove crock and let cool.



4

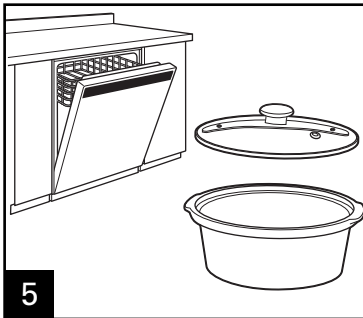

5

Dishwasher-safe parts.

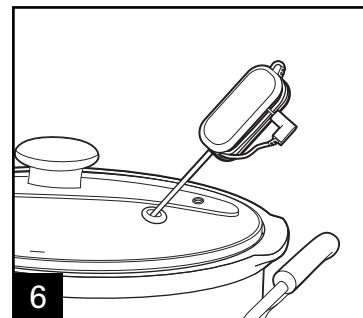

6

Wrap probe wire around handle for storage.

- Handle the Crock and Glass Lid with care to ensure long life.
- Avoid sudden, extreme temperature changes. Do not place hot Crock or Glass Lid into cold water, or on a cold surface.
- Avoid Crock and Glass Lid coming in contact with a faucet or other hard surfaces.
- Do not use Crock and Glass Lid if chipped, cracked, or scratched.
- Do not use abrasive cleansers or metal scouring pads.
- The bottom of the Crock is very rough and can scratch your countertop. Use caution.
- The Crock and Glass Lid can become very hot. Do not place directly on any unprotected surface.
- The **Crock is microwave safe and oven proof**, but do not use the Crock when empty. Never place the Crock on a burner.
- Do not place the Glass Lid in a microwave oven or on the stove top.

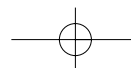

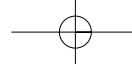

Tips for Slow Cooking

- Foods will continue to increase in temperature after desired temperature has been reached.
- The Crock should be at least half-filled for best results. If only half-filled, check for doneness 1 to 2 hours earlier than recipe.
- Stirring is not necessary when slow cooking and removing the glass lid results in major heat loss and the cooking time may need to be extended. However, if cooking on High, you may want to stir occasionally.
- If cooking soups or stews, leave a 2-inch space between the top of the Crock and the food so that the recipe can come to a simmer.
- Many recipes call for cooking all day. If your morning schedule doesn't allow time to prepare a recipe, do it the night before. Place all ingredients in the Crock, cover and refrigerate overnight. In the morning, simply place the Crock in the slow cooker.
- Do not use frozen, uncooked meat in the slow cooker. Thaw any meat or poultry before slow cooking.
- Some foods are not suited for extended cooking in a slow cooker. Pasta, seafood, milk, cream, or soured cream should be added 2 hours before serving. Evaporated soups are perfect for the slow cooker.
- The higher the fat content of the meat, the longer the cooking time. If cooking meat with a high fat content, place a rack underneath so the meat will not sit on (and burn) the bottom.
- Slow cookers allow for very little evaporation. For your favorite soup, stew, or sauce, reduce the liquid by 1/4 of the original recipe. If too thick, liquid can be added.
- If cooking a vegetable-type casserole, there should be enough liquid in the recipe to prevent scorching on the bottom of the crock.
- To keep previously cooked food warm (for example, for a buffet), select the Warm at the desired temperature), select the Warm function. One of the three cooking modes: Program, Manual, or Warm.
- The cooking time is not affected or slowed down by steam or heat escaping from Probe Hole when present.

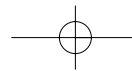
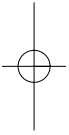

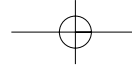

Troubleshooting

POTENTIAL PROBLEM

PROBABLE CAUSE

There is no display visible on the control panel.

- Is the unit plugged in?
- Is the unit turned on? Display should flash **SEL**.
- Test that the electrical outlet is working with a lamp in known working order.
- Power interruption of 5 seconds or longer.

I can't program the current time on the control panel.

- There is no "clock" feature on this slow cooker, only a countdown timer.

Food is undercooked.

- Was food cooked on the Warm setting? Do not cook on Warm setting; always cook on High or Low heat settings.
- Was power interrupted (due to brownout, electrical storm, etc.) for 5 seconds or longer?
NOTE: For a power interruption of 5 seconds or less, the slow cooker will remember heat and time settings.
- Did you select the Low heat setting, but used a cooking time based on the High heat setting?
- Did you have the Glass Lid placed correctly on the slow cooker?

The food isn't done after cooking the amount of time recommended in my recipe.

- This can be due to voltage variations (which are commonplace everywhere) or altitude. Fluctuations in power do not have a noticeable effect on most appliances. However, you can adjust cooking times in the slow cooker by extending the cooking times. Allow sufficient time for the appropriate heat setting. You will learn through experience if the shorter or longer time is appropriate.

My meal was overcooked. Why?

- Was the crock at least half-full? The slow cooker has been designed to thoroughly cook a full crock. If the crock is only half-filled check for doneness 1 to 2 hours earlier than recipe recommends.
- Did you select hours based on a Low heat recipe?
- Foods will continue to increase in temperature after desired temperature has been reached.

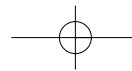

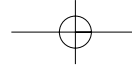

Quick Temperature Probe Recipes

Refer to Cooking Guide for cooking times and temperatures.

Refer to Probe Mode section for probe instructions.

How much does your slow cooker hold? The capacity of your slow cooker refers to the amount the crock can hold if it is filled. However, we DO NOT recommend filling to the rim. As a rule, you should select recipes that yield 1 quart less than the capacity. For example, if your Slow Cooker is 6-quarts, your best results will be achieved using recipes that yield 5 quarts or less.

Maple Boneless Pork Roast **5 OR 6 QUART SLOW COOKER**

Place 4-5 lb. (2-2.2 kg) boneless pork roast in slow cooker. Season with salt and pepper. Pour 1/2 cup (125 ml) of good quality maple syrup over pork. Spread top of pork roast with 3 teaspoons (15 ml) of Dijon mustard. Top with 3 tablespoons (45 ml) brown sugar. Cover and cook according to Cooking Guide.

Chicken Pieces with Lemon and Fresh Rosemary **5 OR 6 QUART SLOW COOKER**

Rinse and pat dry 4 lb. (2 kg) chicken pieces. Place pieces evenly in bottom of slow cooker. Juice one lemon and pour over chicken liberally with paprika. Top with 3-4 sprigs of fresh rosemary. Cover, insert probe, and cook according to Cooking Guide.

Cuban Pork Roast **5 OR 6 QUART SLOW COOKER**

In a small bowl mix together 1 teaspoon (5 ml) chili powder, 1 teaspoon (5 ml) ground cumin, 1 teaspoon (5 ml) salt, 1 teaspoon (5 ml) dried oregano, 3 tablespoons (45 ml) fresh lemon juice, 3 tablespoons (45 ml) fresh lime juice, 2 tablespoons (30 ml) oil, and 1/4 cup (60 ml) soy sauce. Place (1.5-2.2 kg) pork roast in zip-top bag and pour mixture over. Marinate overnight in refrigerator. When ready to cook place roast in slow cooker. Cover, insert probe, and cook according to Cooking Guide.

Creole Chicken **5 OR 6 QUART SLOW COOKER**

Remove neck and giblets from 3-4 lb. (1.5-2 kg) whole chicken. Rinse, pat dry and season with Creole seasoning (available in most grocery stores). Place chicken in slow cooker. Cover, insert probe, and cook according to Cooking Guide.

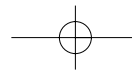

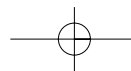

Quick Temperature Probe Recipes

Apricot Glazed Chicken 5 OR 6 QUART SLOW COOKER

Remove neck and giblets from 3-4 lb. (1.5-2 kg) whole chicken. Rinse, pat dry and season with salt and pepper. Place in slow cooker. Add contents of 12 oz. (360 ml) jar of apricot preserves over chicken. Cover, insert probe, and cook according to Cooking Guide.

Cajun Spiced Turkey Breast 6 QUART SLOW COOKER

Remove neck and giblets from 6-7 lb. (3-3.5 kg) turkey breast, rinse and pat dry. Using your favorite Cajun spice mix (available at most grocery stores), season cavity and outside of turkey breast liberally. Place turkey breast side up, in slow cooker. Cover, cook according to Cooking Guide.

Citrus Pineapple Smoked Ham 6 QUART SLOW COOKER

Place 7 1/2 lb. (3.5 kg) precooked smoked ham in slow cooker. Press 1/2 cup (125 ml) of brown sugar on surface of ham. Drain and place 1 can of pineapple chunks, reserving juice, and place pineapple on and around ham. Pour 1/2 cup (125 ml) of reserved pineapple juice in slow cooker. Zest one large orange and spread over ham. Cover, insert probe, and cook according to Cooking Guide.

Visit ***hamiltonbeach.com***
for delicious recipes and
to register your product online!

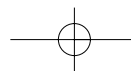

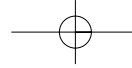

Limited Warranty

This warranty applies to products purchased in the U.S. or Canada.

This product is warranted to be free from defects in material and workmanship for a period of one (1) year from original purchase, except as noted below. During this period, we will repair or replace this product at our option. **THE FOREGOING WARRANTY IS IN LIEU OF ANY OTHER WARRANTY OR CONDITION, WHETHER EXPRESS OR IMPLIED, WRITTEN OR ORAL INCLUDING, WITHOUT LIMITATION, ANY STATUTORY WARRANTY OR CONDITION OF MERCHANTABILITY OR FITNESS FOR A PARTICULAR PURPOSE. ANY LIABILITY IS EXPRESSLY LIMITED TO AN AMOUNT EQUAL TO THE PRICE PAID, AND ALL CLAIMS FOR SPECIAL, INCIDENTAL AND CONSEQUENTIAL DAMAGES ARE HEREBY DISCLAIMED.** There is no warranty with respect to the following, which may be supplied with this product, including without limitation glass containers, cutter/strainers, blades, seals, gaskets, clutches, motor brushes, and/or agitators, etc. This warranty is only to the original consumer purchaser and does not cover a defect resulting from abuse, misuse, neglect or failure to clean product regularly in accordance with manufacturer's instructions, use for commercial purposes, or any use not in conformity with the printed directions. This warranty gives you specific legal rights, and you may also have other rights which vary from state to state, or province to province. Some states or provinces do not allow limitations on the amount or type of special, incidental or consequential damages, so the foregoing limitations may not apply to you.

If you have a claim under this warranty, **DO NOT RETURN THE APPLIANCE TO THE STORE!** Please call our Customer Service Number. (For faster service please have model, series, and type numbers ready for operator to assist you.)

CUSTOMER SERVICE NUMBERS

In the U.S. 1.800.851.8900

In Canada 1.800.267.2826

In Mexico 01.800.71.16.100

hamiltonbeach.com

KEEP THESE NUMBERS FOR FUTURE REFERENCE!

