

This Owner's Manual is provided and hosted by [Appliance Factory Parts](#).



# HAMILTON BEACH 33150 Owner's Manual

[Shop genuine replacement parts for HAMILTON  
BEACH 33150](#)



[Find Your HAMILTON BEACH Small Appliance Parts - Select From 252 Models](#)

----- Manual continues below -----

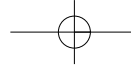

**READ BEFORE USE**  
**LIRE AVANT UTILISATION**  
**LEA ANTES DE USAR**

Visit [hamiltonbeach.com](http://hamiltonbeach.com) for delicious recipes, tips, and to register your product online!



Consulter [hamiltonbeach.ca](http://hamiltonbeach.ca) pour les recettes délicieuses, conseils pratiques, et pour enregistrer votre produit!

Visite [hamiltonbeach.com.mx](http://hamiltonbeach.com.mx) para recetas deliciosas, consejos, y para registrar su producto en línea.

**Questions?**

Please call us – our friendly associates are ready to help.  
USA: 1.800.851.8900

**Questions?**

N'hésitez pas à nous appeler – nos associés s'empresseront de vous aider.  
CAN: 1.800.267.2826

**¿Preguntas?**

Por favor llámenos – nuestros amables representantes están listos para ayudar.  
MEX: 01 800 71 16 100

*Le invitamos a leer cuidadosamente este instructivo antes de usar su aparato.*

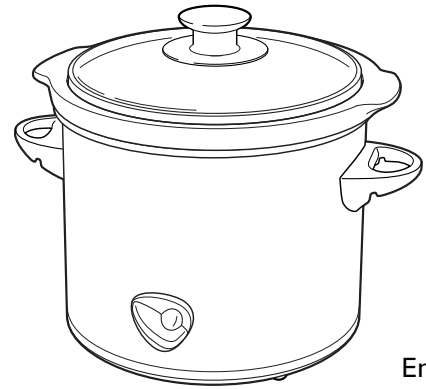

**Hamilton**

Slow

Olla

Engl  
Fran  
Espa

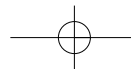

## IMPORTANT SAFEGUARDS

When using electrical appliances, basic safety precautions should always be followed to reduce the risk of fire, electric shock, or injury to persons, including the following:

1. Read all instructions.
2. Do not touch hot surfaces. Use handles or knobs.
3. To protect against electrical shock do not immerse cord, plug, or base in water or other liquid.
4. Close supervision is necessary when any appliance is used by or near children.
5. Unplug from outlet when not in use and before cleaning. Allow to cool before putting on or taking off parts.
6. Do not operate any appliance with a damaged cord or plug, or after the appliance malfunctions or is dropped or damaged in any manner. Call our toll-free customer service number for information on examination, repair, or adjustment.
7. The use of accessory attachments not recommended by the appliance manufacturer may cause injuries.
8. Do not use outdoors.
9. Do not let cord hang over edge of table or other surfaces, including stove.
10. Do not place on or near hot gas or an electric heated oven.
11. Extreme caution must be used when moving appliance containing hot oil or other hot liquids.
12. To disconnect slow cooker, turn control knob and pull plug from wall outlet.
13. Caution: To prevent damage or shock hazard, do not touch hot surfaces. Cook only in removable crock.
14. Avoid sudden temperature changes, such as adding cold foods into a heated crock.
15. Do not use appliance for other than intended purposes.

## SAVE THESE INSTRUCTIONS!

### OTHER CONSUMER SAFETY INFORMATION

**This product is intended for household use only.**

This product is only intended for the preparation, cooking, and serving of foods. This product is not intended for use with any non-food materials or products.

**WARNING!** Shock Hazard: This appliance has a polarized plug (one wide blade) that reduces the risk of electric shock. The plug fits only one way into a polarized outlet. Do not defeat the safety purpose of the plug by modifying the plug in any way or using an adaptor. If the plug does not fit, reverse the plug. If it still does not fit, have an electrician replace the outlet.

2

The length of the cord used on this appliance was selected to minimize the hazards of becoming tangled in, or tripping over. If a longer cord is necessary an approved extension cord should be used. The electrical rating of the extension cord should be equal to or greater than the rating of the appliance. Care should be taken to arrange the extension cord so that it will not drape over the top or tabletop where it can be pulled on by children or tripped over.

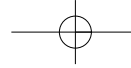

## **CROCK AND LID: PRECAUTIONS AND INFORMATION**

- Please handle crock and lid carefully to ensure long life.
- Avoid sudden, extreme temperature changes. For example, do not place a hot lid or crock into cold water, or onto a wet surface.
- Avoid hitting crock or lid against faucet or other hard surfaces.
- Do not use crock or lid if chipped, cracked, or severely scratched.
- Do not use abrasive cleansers or metal scouring pads.
- The bottom of crock is very rough and can damage other surfaces. Use caution.
- The crock and lid can become very hot. Use caution when touching directly on any unprotected surface or countertop.
- The crock is microwave safe and oven proof, but not for use when empty. Never place lid on a burner or stove. To clean, place lid in a microwave oven, conventional oven, or dishwasher.

## **REMOVING LID AND CROCK**

When removing lid, tilt so that opening faces away from you to avoid being burned by steam.

The sides of the slow cooker's base get very hot. Heating elements are located here. Use handles to lift crock. Use hot mitts to remove crock.

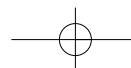
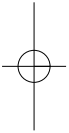

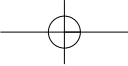

# Parts and Features

## Crock Capacity

For best results, fill the crock at least half-full but no more than one inch from the rim. If only half-filled, check for doneness 1 to 2 hours earlier than recipe.

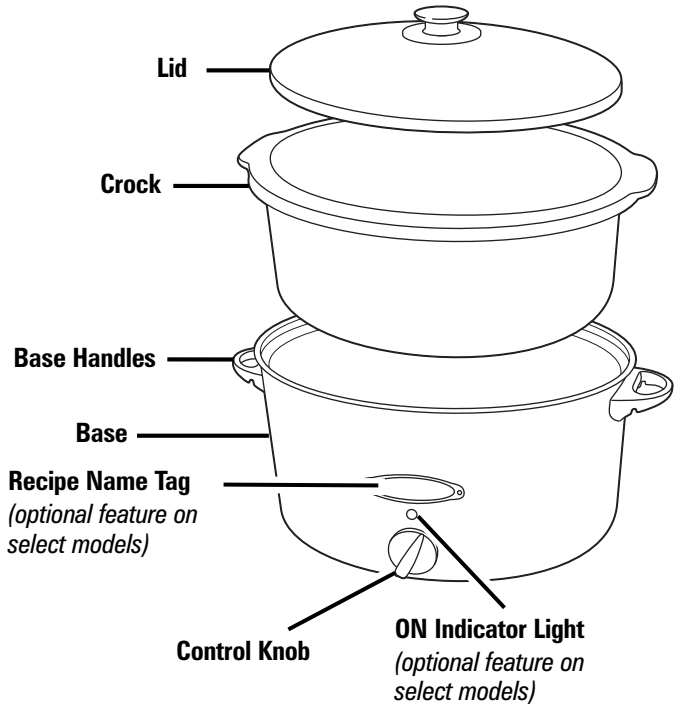

4

## Optional features on select models

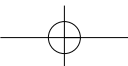
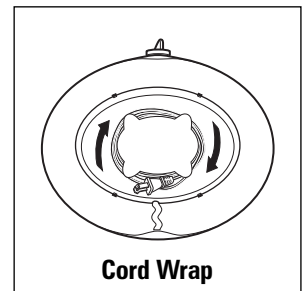
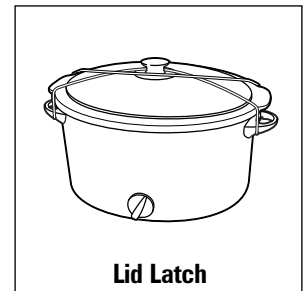
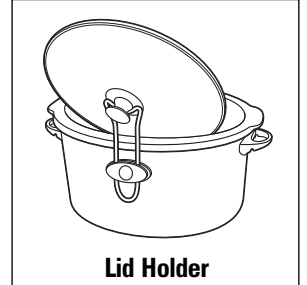

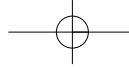

# How to Use Your Slow Cooker

**Before First Use:** Wash lid and crock in hot, soapy water. Rinse and dry.

**⚠ WARNING Food Safety Hazard.** Food may not be cooked enough to prevent bacterial growth by using the Keep Warm setting. The Keep Warm setting is only for use after a recipe has been thoroughly cooked. Do not keep food on Keep Warm setting. If food has been kept on Keep Warm then refrigerated, reheat it on Low or High setting. Visit [foodsafety.gov](http://foodsafety.gov) for more information.

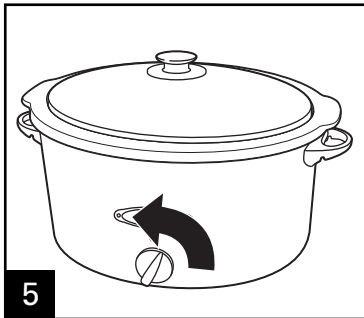
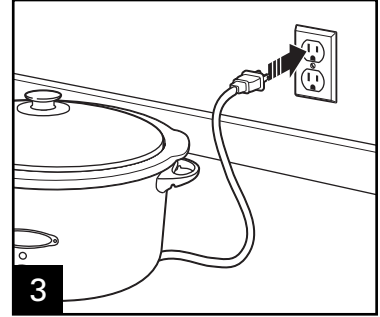
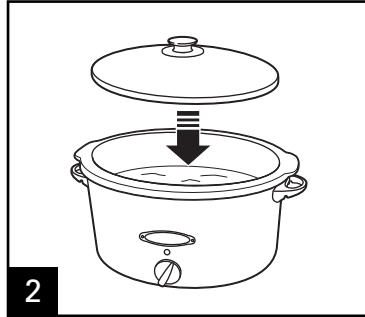
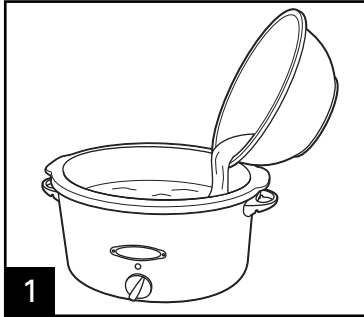

When cooking is finished, turn OFF.

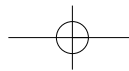

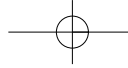

## Cleaning and Care

**⚠ WARNING**

**Electrical Shock Hazard.**

Disconnect power before cleaning. Do not immerse crock or base in any liquid.

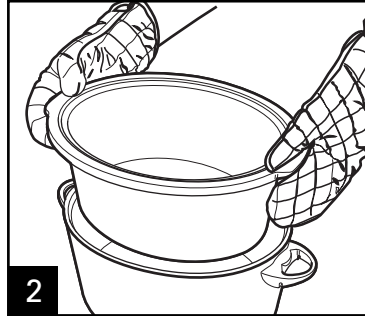
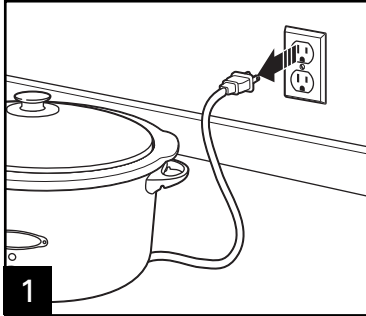

Remove crock and let cool.

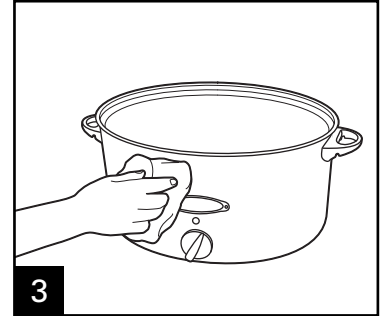

## How to Use Lid Latch™ (optional feature on some models)

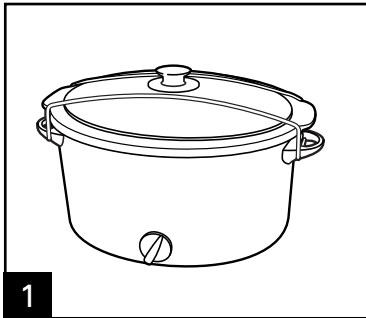

Place latch into groove under one handle. Stretch to other side and secure in groove under other handle.

6

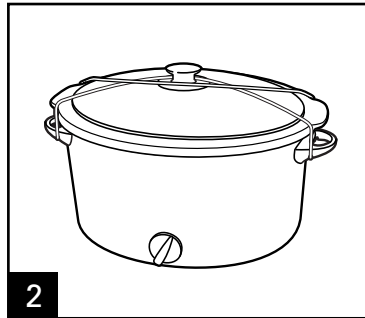

Once attached, latch can also be crossed over knob to further secure lid.

The Lid Latch™ helps secure lid while moving, transporting, or storing slow cooker.

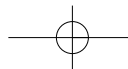

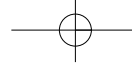

## *Tips for Slow Cooking*

- The crock should be at least half-filled for best results. If only half-filled, check for doneness 1 to 2 hours earlier than recipe.
- Stirring is not necessary when slow cooking and removing glass lid results in major heat loss and the cooking time may need to be extended. However, if cooking on High, you may want to stir occasionally.
- If cooking soups or stews, leave a 2-inch (5 cm) space between the top of the crock and the food so that the recipe can come to a simmer.
- Many recipes call for cooking all day. If your morning schedule doesn't allow time to prepare a recipe, do it the night before. Place all ingredients in crock, cover with lid and refrigerate overnight. In the morning, simply place crock in slow cooker.
- Do not use frozen, uncooked meat in slow cooker or poultry before slow cooking.
- Some foods are not suited for extended cooking. Pasta, seafood, milk, cream, or sour cream should be added before serving. Evaporated milk or condensed milk are fine for slow cooking.
- The higher the fat content of meat, the less liquid you need. For meat with a high fat content, place thick onion slices on top. Meat will not sit on (and cook in) fat.
- Slow cookers allow for very little evaporation. For soups, stews, or sauces, reduce liquid called for in recipe. Thick liquid can be added later.
- If cooking a vegetable-type casserole, there will be some scorching on the sides of the crock. Follow the recipe to prevent scorching on the sides of the crock.

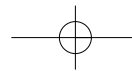

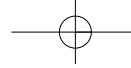

# Cooking Chart

Visit [hamiltonbeach.com](http://hamiltonbeach.com) for more tips, and to register your product.

For best results, fill the crock at least half-full but no more than one inch from rim. Always follow package directions.

RECIPE	3-5 QT/L	6-7 QT/L	8 QT/L	INSTRUCTIONS
Beef Pot Roast	2 lb. (907 g) beef pot roast 1 teaspoon (5 ml) salt 1/2 teaspoon (2.5 ml) pepper 1/4 (60 ml) cup beef broth/water 1/2 to 1 envelope dry onion mix 1 onion, quartered 2 potatoes, quartered 2 carrots, cut in 1" (2.5 cm) pieces	3-5 lb. (1.3-2.2 kg) beef pot roast 1-1/2 teaspoons (7.5 ml) salt 1 teaspoon (5 ml) pepper 1/2 cup (125 ml) beef broth/water 1 envelope dry onion mix 2 onions, quartered 3-4 potatoes, quartered 3-4 carrots, cut in 1" (2.5 cm) pieces	4-6 lb. (1.8-2.7 kg) beef pot roast 2 teaspoons (10 ml) salt 1 teaspoon (5 ml) pepper 3/4 cup (175 ml) beef broth/water 1 envelope dry onion mix 3 onions, quartered 5-6 potatoes, quartered 5-6 carrots, cut in 1" (2.5 cm) pieces	<ol style="list-style-type: none"> <li>Season roast with salt and pepper.</li> <li>Over medium-high heat, brown roast on all sides.</li> <li>Place vegetables in crock.</li> <li>Place roast on top of vegetables.</li> <li>Sprinkle with onion mix.</li> <li>Drizzle beef broth over roast.</li> <li>Cover and cook on LOW for 10 hours or until internal temperature is at least 160°F (71°C).</li> </ol>
Chili	1 lb. (450 g) ground beef 1 1.5 oz (40 g) envelope chili seasoning 1 14.5 oz. (411 g) can diced tomatoes 1 16 oz. (453 g) can kidney beans, (drained and rinsed)	2 lb. (907 g) ground beef 2 1.5 oz (40 g) envelopes chili seasoning 2 14.5 oz. (411 g) can diced tomatoes 2 16 oz. (453 g) can kidney beans, (drained and rinsed)	4 lb. (1.8 kg) ground beef 4 1.5 oz (40 g) envelopes chili seasoning 4 14.5 oz. (411 g) can diced tomatoes 4 16 oz. (453 g) can kidney beans, (drained and rinsed)	<ol style="list-style-type: none"> <li>Combine beef, chili seasoning, and kidney beans in crock.</li> <li>Cover and cook on LOW for 8 hours or until temperature is at least 160°F (71°C).</li> </ol>
Whole Chicken	3 lb. (1.3 kg) whole chicken 2 garlic cloves, peeled 1/2 lemon 1 bay leaf 1 teaspoon (5 ml) salt 1/2 teaspoon (2.5 ml) pepper 1 teaspoon (5 ml) paprika	4-6 lb (1.8-2.7 kg) whole chicken (or two 3 lb. [1.3 kg] chickens) 3 garlic cloves, peeled 1/2 lemon 2 bay leaves 2 teaspoons (10 ml) salt 1 teaspoon (5 ml) pepper 1-2 teaspoons (5-10 ml) paprika	7-8 lb (3.2-3.6 kg) whole chicken 4 garlic cloves, peeled 1 lemon, halved 3 bay leaves 1 tablespoon (10 ml) salt 1-1/2 teaspoons (7.5 ml) pepper 2 teaspoons (10 ml) paprika	<ol style="list-style-type: none"> <li>Remove giblets/neck.</li> <li>Place garlic, lemon and bay leaves in crock.</li> <li>Season chicken(s) with salt and paprika.</li> <li>Place chicken(s) in crock.</li> <li>Cover and cook on LOW for 8 hours or until internal temperature is at least 165°F (74°C).</li> </ol>

Visit [www.foodsafety.gov](http://www.foodsafety.gov) for more information on safe internal cooking temperatures.

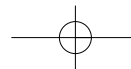

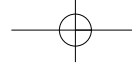

# Troubleshooting

## POTENTIAL PROBLEM

**Food is undercooked.**

**The food isn't done after cooking the amount of time recommended in my recipe.**

**My meal was overcooked. Why?**

**Lid gasket collapsed.**

## PROBABLE CAUSE

- Was food cooked on the Keep Warm setting? Do not cook on Keep Warm; always cook on High heat settings.
- Was power interrupted?
- Did you select the Low heat setting, but use a cooking time based on the High heat setting?
- Did you have the lid placed correctly on the slow cooker?
- This can be due to voltage variations (which are commonplace everywhere) or altitude. Fluctuations in power do not have a noticeable effect on most appliances. However, you can adjust cooking times in the slow cooker by extending the cooking times. Allow sufficient time for the appropriate heat setting. You will learn through experience if a shorter or longer time is needed.
- Was the crock at least half-full? The slow cooker has been designed to thoroughly cook a full crock. If the crock is only half-filled, check for doneness 1 to 2 hours earlier than recommended.
- Did you select correct number of hours based on cooking temperature (Low or High)?
- Foods will continue to increase in temperature after desired temperature has been reached.
- This can be caused by sudden temperature change, like running cold water over a crock. Let it sit at room temperature. It will return to the original shape within 24 hours.
- To help maintain the shape of the gasket, do not cook with clips latched and do not store with clips latched.

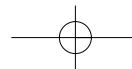
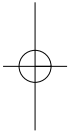

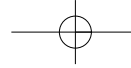

## Limited Warranty

This warranty applies to products purchased in the U.S. and Canada. This is the only express warranty for this product. There is no other warranty or condition.

This product is warranted to be free from defects in material and workmanship for a period of one (1) year from the purchase. During this period, your exclusive remedy is repair or replacement of this product or any component found to be defective at our option; however, you are responsible for all costs associated with returning the product to us and our return shipping charges. A replacement component under this warranty to you. If the product or component is no longer available, we will replace with a similar or greater value.

This warranty does not cover glass, filters, wear from normal use, use not in conformity with the printed directions, or damage to the product resulting from accident, alteration, abuse, or misuse. This warranty extends only to the original consumer purchaser or recipient. Keep the original sales receipt, as proof of purchase is required to make a warranty claim. This warranty is not valid if used for other than single-family household use.

We exclude all claims for special, incidental, and consequential damages caused by breach of express or implied warranty. All liability is limited to the amount of the purchase price. **Every implied warranty, including any statutory warranty of merchantability or fitness for a particular purpose, is disclaimed except to the extent prohibited by law, in which case the implied warranty or condition is limited to the duration of this written warranty.** This warranty gives you specific legal rights. You may have other legal rights that vary depending on where you live. Some states or provinces do not allow limitations on damages, so the foregoing limitations may not apply to you.

To make a warranty claim, do not return this appliance to the store. Please call 1.800.851.8900 in the U.S. or 1.800.235.8900 in Canada or visit [hamiltonbeach.com](http://hamiltonbeach.com) in the U.S. or [hamiltonbeach.ca](http://hamiltonbeach.ca) in Canada. For faster service, locate the model, type, and serial number on your appliance.

