

This Owner's Manual is provided and hosted by [Appliance Factory Parts](#).



LG 69374 Owner's Manual

[Shop genuine replacement parts for LG 69374](#)



^k The color vary in each model

[Find Your LG Refrigerator Parts - Select From 834 Models](#)

----- Manual continues below -----

IMPORTANT DO NOT DESTROY
WIRING DIAGRAMS, SERVICE AND PARTS INFORMATION INCLUDED
REPOSITION TO ORIGINAL LOCATION

FREEZER COMPARTMENT

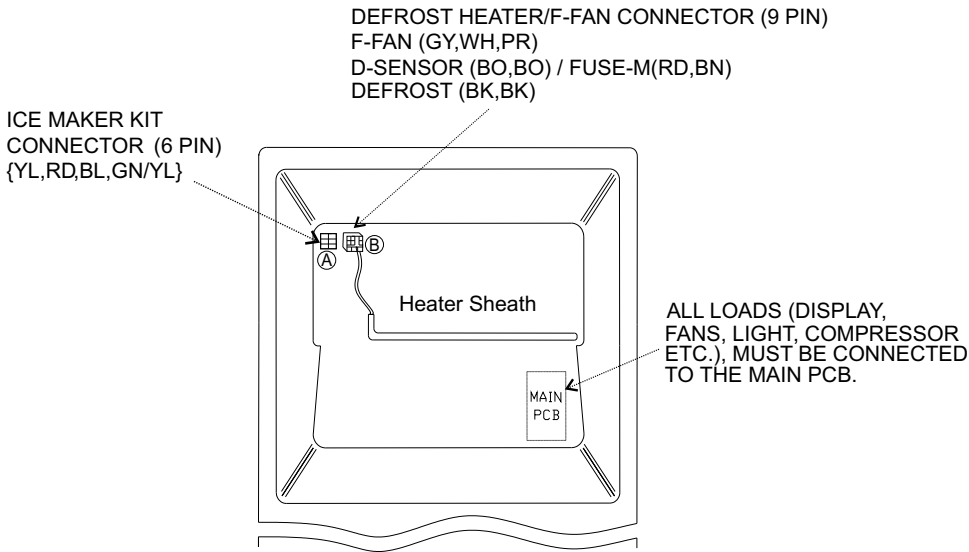

REFRIGERATOR COMPARTMENT

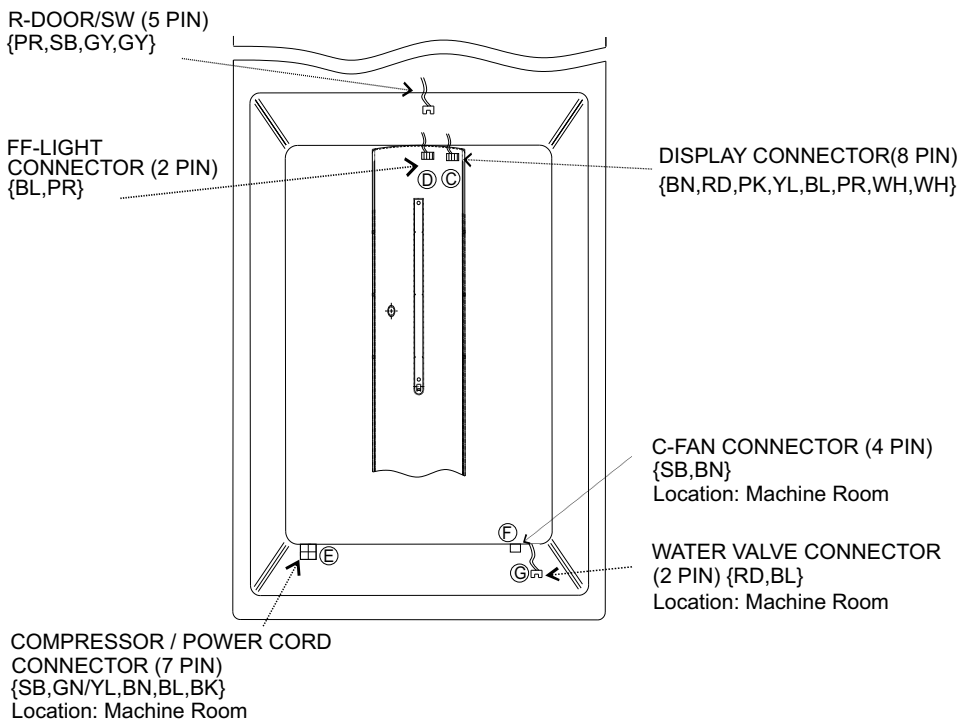

IMPORTANT
WIRING DIAGRAMS, SERVICE AND PARTS INFORMATION INCLUDED
REPOSITION TO ORIGINAL LOCATION

EVAPORATOR FAN ASSY

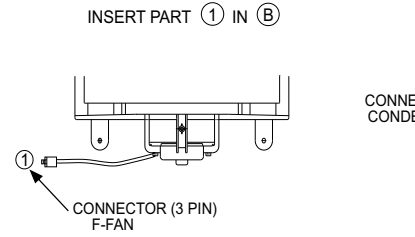

CONTROL BOX

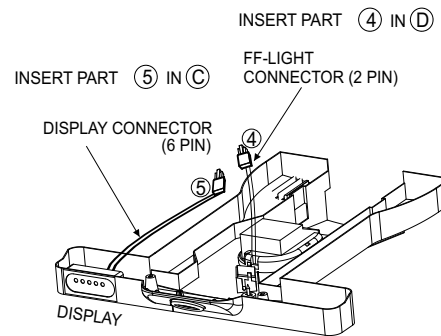

COMPRESSOR KIT

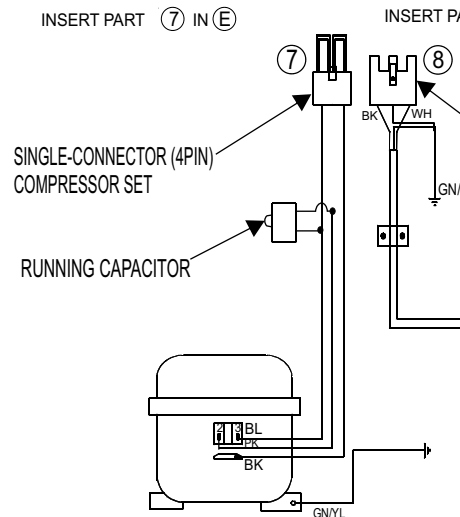

Note: The figures in this page are

MICOM FAILURE DIAGNOSIS TABLE

CAUTION

- 1) If any error is detected, LED number 1 will not be ON and temperature adjust button will be disabled.
- 2) Remove power to unit to end test mode.

(1) FAILURE DIAGNOSIS FUNCTION

In error code, the R1 LED will remain turned OFF.

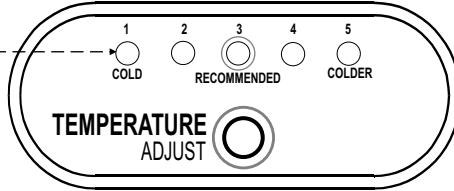

ERROR CODE displayed on Freezer Temp. Panel

○ : ON ● : OFF

NO	ITEM	Error Code					Contents	Product Operation Status in Failure		
		R1	R2	R3	R4	R5		Compressor	Frz motor	Defrost Heater
1	Failure of Refrigerator Sensor	●	●	○	●	●	Cut or short circuit wire.	15 min ON/ 15 min OFF	15 min ON/ 15 min OFF	Normal
2	Failure of Defrost Sensor	●	●	●	○	●	Cut or short circuit wire.	Normal	Normal	No defrost
3	Failure of Room Temperature Sensor	●	●	●	●	○	Cut or short circuit wire.	Normal	Normal	Normal
4	Failure of Defrost Mode	●	○	○	○	○	When defrost sensor does not reach 50°F within 1 hour after starting defrost	Normal	Normal	Normal
5	Failure of BLDC Fan Motor at freezer compartment.	●	●	○	○	○	If there is no fan motor signal for more than 115 seconds in operation fan motor.	Normal	OFF	Normal

(2) TEST FUNCTION

* TEST BUTTON located in the MAIN PWB BOARD.

MODE	MANIPULATION	CONTENTS	REMARKS
TEST 1	Push the test button once.	1) COMP, FFAN and CFAN ON. 2) DEFROSTING HEATER OFF 3) ALL DISPLAY ON 4) LAMP RELAY ON/OFF OPERATED BY DOOR SWITCH.	The maximum time for TEST1 is 5 min.
TEST 2	Push the test button once while in TEST MODE 1. NOTE: To enter this mode, Freezer Compartment must be under 50°F (10°C).	1) COMP, FFAN and CFAN OFF. 2) DEFROSTING HEATER ON 3) DISPLAY LED (Please refer to the next figure)	<p>○ : ON ● : OFF Operate max 1 Hr</p>
Return to normal condition	Push the test button once while in TEST MODE 2.	Return to normal state (compressor will delay 7 minutes for power ON)	

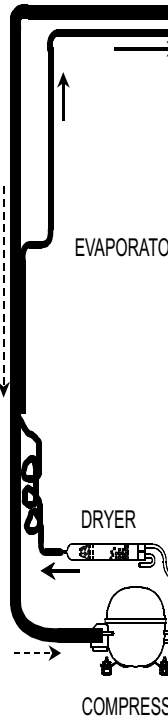

— COLD AIR
— MIXED AIR
- - - AIR RETURN TO EVAPORATOR

EVAPORATOR