

This Owner's Manual is provided and hosted by [Appliance Factory Parts](#).



LG 71306 Owner's Manual

[Shop genuine replacement parts for LG 71306](#)



* The color vary in each model

[Find Your LG Refrigerator Parts - Select From 834 Models](#)

----- Manual continues below -----

IMPORTANT DO NOT DESTROY

WIRING DIAGRAMS, SERVICE AND PARTS INFORMATION INCLUDED
REPOSITION TO ORIGINAL LOCATION

REFRIGERATOR COMPARTMENT

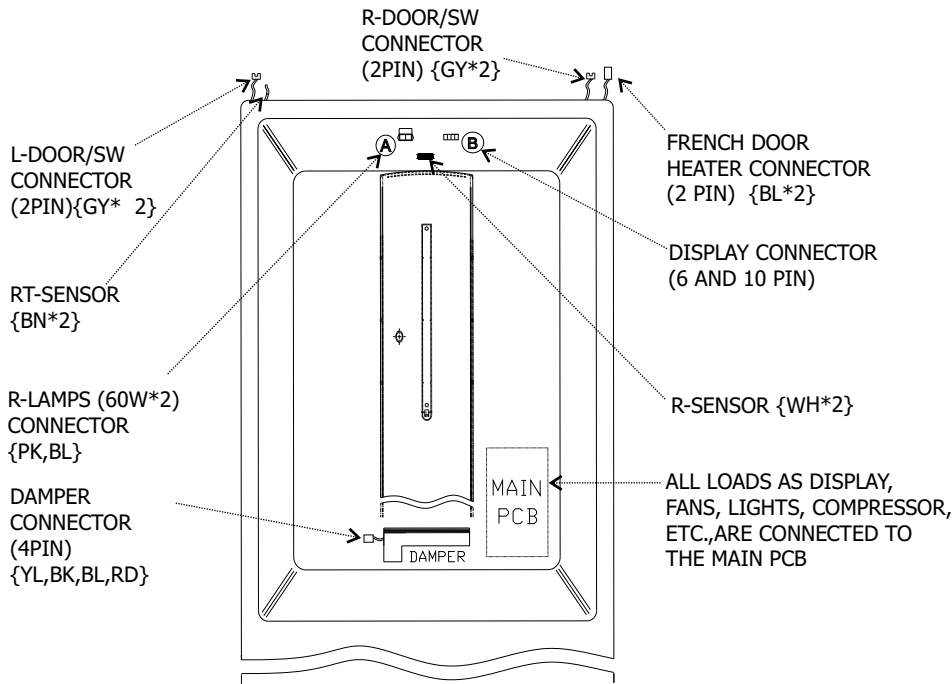

FREEZER COMPARTMENT

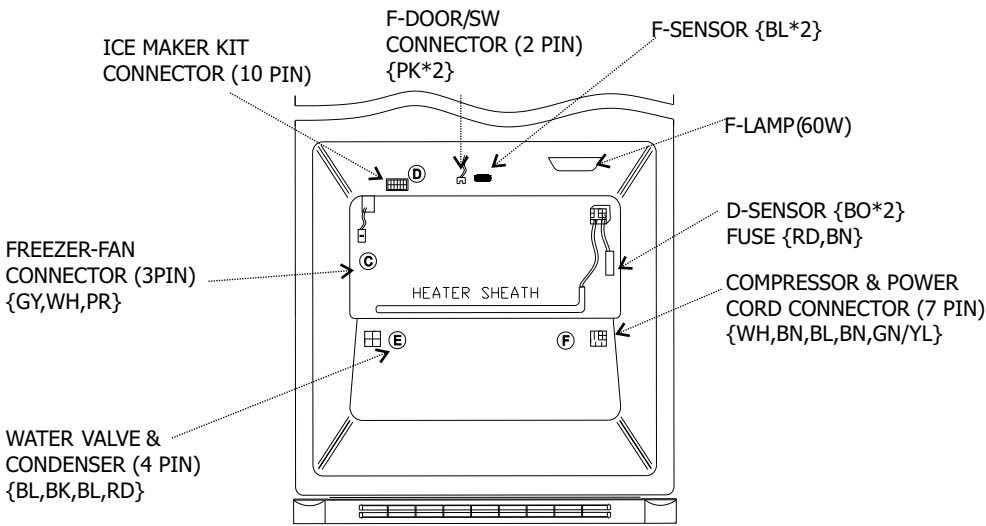

EVAPORATOR FAN ASSY

INSERT PART ② IN ③

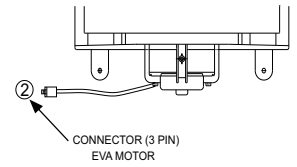

CONTROL BOX

PUT ① INTO ①

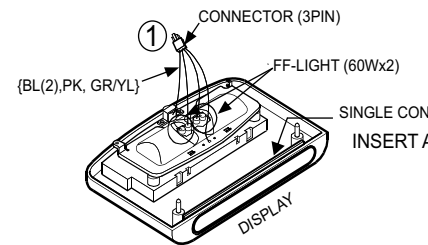

OVERLOAD PROTECT

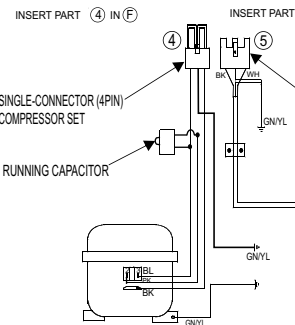

Note: The figures in this page are

FAILURE DIAGNOSIS TABLE

PCB TEST BUTT

Defect Diagnosis Function

Micom error are separated in "Main Errors" (Affect directly refrigerator performance) and "Secondary Errors" (don't affect the refrigerator performance). To check in Display the error present, is necessary press Cold key on freezer and Cold key on refrigerator more than 1 Second, if no there any error, all LED will be illuminated, if a main error is present, only certain LED will be illuminated, in case of secondary errors, only one LED or icon will not illuminated.

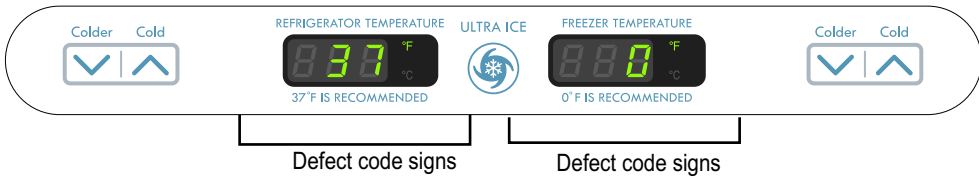

ERROR CODE on display panel

No.	Item	Error Indication		Contents	Remarks
1	Normal	NOTCH Indication		None	DISPLAY switch operates normally
2	Failure of Freezer sensor	Er	Fs	Cut or short circuit wire	Inspect Connecting wires on each sensor
3	Failure of Refrigerator sensor	Er	rS	Cut or short circuit wire	
4	Failure of Defrost sensor	Er	dS	Cut or short circuit wire	
5	RT-Sensor Error	Er	rt	Cut or short circuit wire	
6	Failure of Defrost mode	Er	dH	When defrost sensor does not reach 8°C within 1 hour after starting defrost.	
7	Failura of BLDC fan motor at freezing compartment	Er	FF	If there is no fan motor signal for more than 115 sec in operation fan motor.	Poor motor, hooking to wires of fan, contact of structures to fan, snapping or short circuit of lead wires.
8	Failure of Icemaker Kit	Er	It	Failure of wires such as motor in I/M KIT GEAR, HALL IC	When the ice ejecting does not operated on pressing the I/M TEST S/W
9	Failure of Icemaker sensor	Er	IS	Snapping or short circuit of ice making sensor	Connecting wire Test On Sensor

Primary Error: F sensor, R1 sensor, D sensor, Defrost errors, F-FAN errors.
Secondary Error: I / M sensors, I / M Kit, RT sensor.

When an error occur the first 3 hours the Primary Error and Secondary Error is indicated in the display check mode (Pressing Cold key on freezer and Cold key on refrigerator more than 1 Second). After the 3 hours and if the error is still present the Primary Error will show in the display automatically (See Note 1) and the Secondary Error is indicated in the display check mode.

Note1: In the Primary Error after 3 hours of the error occur all display lights turn OFF except the Freezer Temperature (Trouble Code Index) indicating the failure mode.

*LED check function: When there's no error, If simultaneously pressing the Cold key of Refrigerator Temp and the Cold key of freezer temp for a second, all display LED graphics on. If releasing the button, the LED graphics displays the previous status.

Note2: In Case of Icemaker ready models, discard Icemaker Sensor error until Icemaker kit will be connected.

TEST Mode

- The Test mode allows checking the PCB the defective part in case of an error.
- The test mode is operated by pressing
- While in the test mode, the function code (beep~) sounds.
- After exiting the test mode, be sure to r
- If an error, such as a sensor failure, is c and the error code is displayed.
- While an error code is displayed, the te

MODE	OPERATION	
TEST1	Push TEST switch (on the main Board) Once. <Cooling MODE>	1. Contin and th 2. Stepp 3. Defros 4. Displa
TEST2	Push TEST switch once in TEST MODE 1. < Forced defrosting MODE>	1. Comp 2. Stepp 3. Defro 4. Displa
Return to Normal	Push Test switch on the main PCB once.	Return to

* Freezer Fan RPM Variable Check:
 If the freezer fan is in operation when the C FREEZER TEMP KEY are pressed for mor freezer fan RPM changes. (for example if h to high speed for 30 seconds)
 After 30 seconds, it turns to its original RPM

* Demonstration (Display) MODE:
 1. To enter this mode, raise either the Refri setting. Then, press that Cold key and hold
 2. The LED panels will display OFF, to indi damper, and defrost heater are not operati
 3. The Open Door Alarm and the Lamp Aut demonstrated.
 4. To reset to normal operation, press and

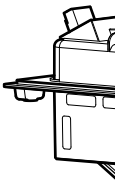
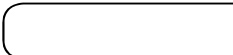

1. ICEMAKER

Test Control

- To operate LINE and S for 3 seconds. The ice Harvest → Fill → Ice

Water Supply Function

This function is for supply water to tray, by finish and tray return to initial position. Water If water supply setting is changed while sys Immediately. But if change occurs when wa next cycle of icemaker

Water Supply Time Table

No	DISP S/W		Water S
	S1	S2	
1	OFF	OFF	
2	ON	OFF	
3	OFF	ON	
4	ON	ON	