

This Owner's Manual is provided and hosted by [Appliance Factory Parts](http://Appliance Factory Parts).



# THERMALZONE WAC24230M Owner's Manual

[Shop genuine replacement parts for THERMALZONE  
WAC24230M](#)



[Find Your THERMALZONE Air Conditioner Parts - Select From 27 Models](#)

----- Manual continues below -----



# WINDOW AIR CONDITIONER INSTALLATION AND OPERATION



CATALOG NO.	PRODUCT CODE
WAC18230R	420-0018
WAC24230R	420-0021

CATALOG NO.	PRODUCT CODE
WAC24230M	420-0022

## TABLE OF CONTENTS

AIR CONDITIONER SAFETY.....	2
INSTALLATION REQUIREMENTS.....	3
INSTALLATION INSTRUCTIONS.....	5
THRU-THE-WALL CABINET INSTALLATION.....	9
AIR CONDITIONER USE.....	11
AIR CONDITIONER CARE.....	13
TROUBLESHOOTING.....	14
SPECIFICATIONS.....	16
WARRANTY.....	17

## TECHNICAL SUPPORT

IF YOU NEED TECHNICAL SUPPORT, PLEASE CALL (705) 504-8590 BETWEEN THE HOURS OF  
8:00 A.M. and 5:00 P.M. EST.

PLEASE HAVE THE MODEL NUMBER AND SERIAL NUMBER OF YOUR EQUIPMENT AVAILABLE  
WHEN YOU CALL.

## AIR CONDITIONER SAFETY

Your safety and the safety of others is very important  
We have provided many important safety messages in this manual and on your appliance.  
Always read and follow all safety instructions.



This is the safety alert symbol.  
This symbol alerts you to potential hazards that can kill or hurt you or others.

All safety messages will follow the safety alert symbol and the word "DANGER" or  
"WARNING".

These words mean:



You can be seriously injured if instructions are not followed.



Bodily injury or damage to personal property may occur if instructions are not followed.

All safety messages will tell you what the potential hazard is, tell you how to reduce the chance of injury, and tell you what can happen if the instructions are not followed.

## IMPORTANT SAFETY INSTRUCTIONS

**WARNING:** To reduce the risk of fire, electrical shock or injury when using your air conditioner, follow these basic precautions:

- Plug into a grounded 3 prong outlet.
- Do not remove ground prong.
- Do not use an adapter.
- Do not use an extension cord.
- Unplug Air Conditioner before servicing.
- Use two or more people to move and install air conditioner.

## INSTALLATION REQUIREMENTS

### Tools and Parts

Gather the required tools and parts before starting installation.

Read and follow the instructions provided with any tools listed here.

#### Tools Needed:

Flat-blade and Phillips Screwdrivers

Tape measure

Drill and 3/16" or smaller bit

Level

#### Parts supplied (on some models)

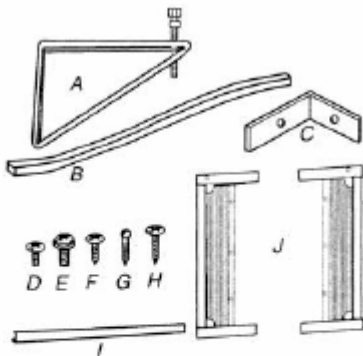

A. Support brackets with adjustment bolts (2)  
B. Foam seals (2)  
C. Window lock bracket (2)  
D. #10 x 1/2" pan-head Phillips screws (6)  
E. #10 x 3/8" washer-head Phillips screws (4)

F. #10 x 1/2" pan-head Phillips screws (4)  
G. #10 x 3/4" round-head screws (6)  
H. #10 x 3/8" pan-head Phillips screws (4)  
I. Top channel  
J. Side curtains (2)

### Location Requirements

**IMPORTANT:** Observe all governing codes and ordinances.

Check the location where air conditioner will be installed. Proper installation is your responsibility. Make sure you have everything necessary for correct installation.

The location should provide:

- Grounded electrical outlet within 4 ft (122 cm) of where the power cord exits the air conditioner.

**NOTE:** Do not use an extension cord.

- Free movement of air in room to be cooled.
- A large enough opening for the air conditioner.
- Adequate wall support for weight of air conditioner. Air conditioner weights between 145 and 200 lbs (65 to 96 kg).

**NOTE:** Cabinet louvers must not be obstructed. Air must be able to pass freely through the cabinet louvers.

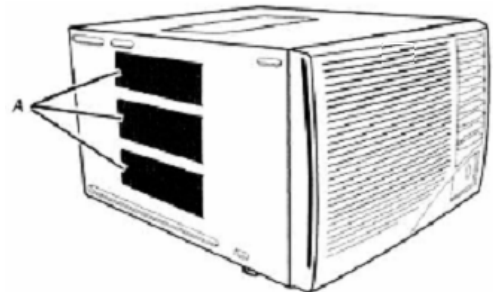

A. Cabinet louvers

**NOTE:** Installation parts are supplied for double-hung windows up to 40: (101.6cm) wide.

## WINDOW INSTALLATION

Window Opening Measurements:

- 30" min to 40" max. opening width.
- 20" Min. opening height.

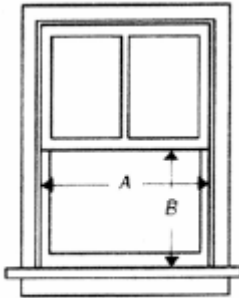

A. 30" min. (76.2 cm)  
B. 20" min. (50.8 cm)

## Electrical Requirements

**⚠ WARNING**



**Electrical Shock Hazard**

Plug into a grounded 3 prong outlet.

Do not remove ground prong.



Do not use an adapter.

Do not use an extension cord.

Failure to follow these instructions can result in death, fire, or electrical shock.

### Power supply cord

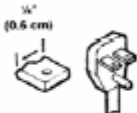
#### Wiring requirements

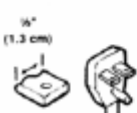
	<ul style="list-style-type: none"> <li>■ 115-volt (103.5 min. - 126.5 max.)</li> <li>■ 0-12 amps</li> <li>■ 15-amp time-delay fuse or circuit breaker</li> <li>■ Use on single outlet circuit only.</li> </ul>
	<ul style="list-style-type: none"> <li>■ 230-volt (207 min. - 253 max.)</li> <li>■ 0-12 amps</li> <li>■ 15-amp time-delay fuse or circuit breaker</li> <li>■ Use on single outlet circuit only.</li> </ul>
	<ul style="list-style-type: none"> <li>■ 230-volt (207 min. - 253 max.)</li> <li>■ 0-16 amps</li> <li>■ 20-amp time-delay fuse or circuit breaker</li> <li>■ Use on single outlet circuit only.</li> </ul>
	<ul style="list-style-type: none"> <li>■ 230-volt (207 min. - 253 max.)</li> <li>■ 0-24 amps</li> <li>■ 30-amp time-delay fuse or circuit breaker</li> <li>■ Use on single outlet circuit only.</li> </ul>

## Recommended Grounding Method

This air conditioner must be grounded. This air conditioner is equipped with a power supply cord having a grounded 3 prong plug. To minimize possible shock hazard, the cord must be plugged into a mating, grounded 3 prong outlet, grounded in accordance with all local codes and ordinances. If a mating outlet is not available, it is the customer's responsibility to have a properly grounded 3 prong outlet installed by a qualified electrical installer. It is the customer's responsibility:

- To contact a qualified electrical installer.
- To assure that the electrical installation is adequate and in conformance with National Electrical Code, ANSI/NFPA 70- latest edition, and all local codes and ordinances.

Copies of the standards listed may be obtained from:

National Fire Protection Association  
One Batterymarch Park  
Quincy, MA 02269

## Power Supply Cord

**NOTE:** Your unit's device may differ from the ones shown.

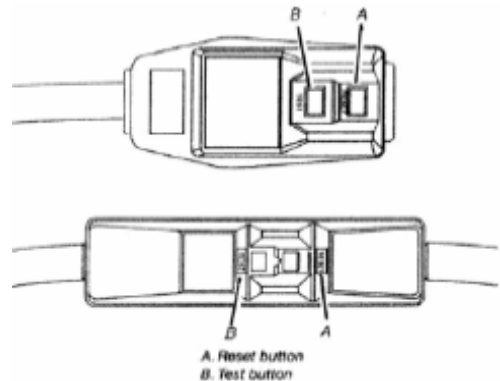

This room air conditioner is equipped with a power supply cord required by UL. This power supply cord contains state-of-the-art electronics that sense leakage current. If the cord is crushed, the electronics detect leakage current and power will be disconnected in a fraction of a second.

**⚠ WARNING**



**Electrical Shock Hazard**

Plug into a grounded 3 prong outlet.

Do not remove ground prong.

Do not use an adapter.

Do not use an extension cord.

Failure to follow these instructions can result in death, fire, or electrical shock.

**To Test your power supply cord:**

1. Plug power supply cord into a grounded 3 prong outlet.
2. Press RESET
3. Press TEST (listen for click, Reset button will trip and pop out).
4. Press and release RESET (listen for click; Reset button will latch and remain in). The power supply cord is ready for operation.

**NOTES:**

- The reset button must be pushed in for proper operation.

- The power supply cord must be replaced if it fails to trip when the test button is pressed or fails to reset.
- Do not use the power supply cord as an off/on switch. The power supply cord is designed as a protective device.
- A damaged power supply cord must be replaced with a new power supply cord obtained from the product manufacturer and must not be repaired.
- The power supply cord contains no user serviceable parts. Opening the tamper-resistant case voids all warranty and performance claims.

**INSTALLATION INSTRUCTIONS**

Unpacking

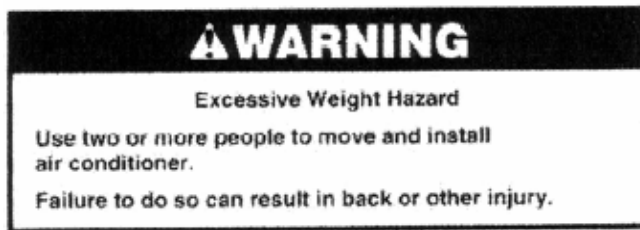

**Remove packaging materials**

- Remove and dispose of/recycle packaging materials. Remove tape and glue residue from surfaces before turning on the air conditioner. Rub a small amount of liquid dish soap over the adhesive with your fingers. Wipe with warm water and dry.
  - Do not use sharp instruments, rubbing alcohol, flammable fluids, or abrasive cleaners to remove tape or glue. These products can damage the surface of your air conditioner.
  - Handle air conditioner gently.
1. Remove the air conditioner from the carton and place it on cardboard.
  2. Remove shipping screws from the rear of the cabinet.

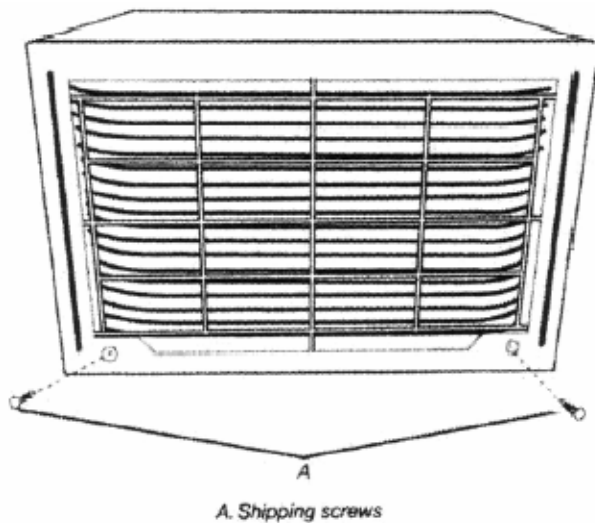

3. Remove the window lock bracket and screw from the air conditioner and set aside.

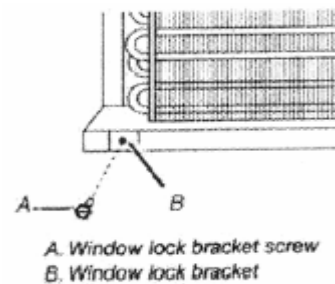

4. Remove the ground screw and ground wire from the front of the air conditioner base. Save the ground screw.

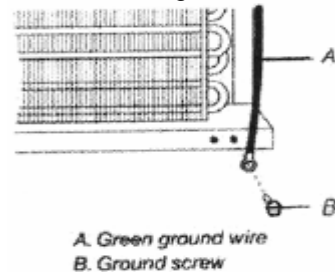

5. Pull on handles to slide air conditioner out of cabinet. Place air conditioner on cardboard.

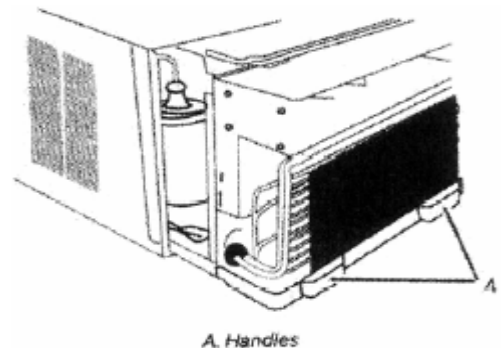

**NOTE:** Do not push, pull or remove any expanded polystyrene (foam) from inside the air conditioner. It is not packing material.

## Window Installation (on some models)

### NOTES:

- Handle air conditioner gently.
- Be sure your air conditioner cabinet does not fall out of the opening during installation or removal.
- The place where the power cord exits the air conditioner should be no more than 4 ft (122 cm) from a grounded 3 prong outlet.
- Do not block the louvers on the front panel.
- Do not block the louvers on the outside of the air conditioner.

### Attach Top Channel

**NOTE:** Attach top channel and side curtains to air conditioner cabinet before placing cabinet in window.

- Locate provided bag of screws.
- Place top channel on top of air conditioner cabinet, lining up the 4 holes in top channel with the 4 holes on top of air conditioner cabinet.
- Using 4 - #10 x 3/8" washer-head Phillips thread cutting screws, attach top channel to air conditioner cabinet.

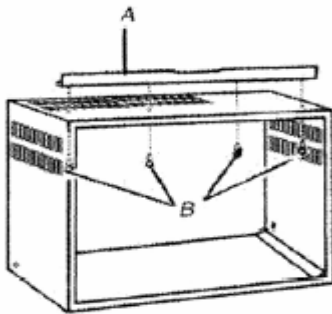

A. Top channel  
B. #10 x 3/8" washer-head Phillips thread-cutting screws

### Attach Side Curtains

- Locate provided bag of screws.
- Insert top and then bottom of right-hand curtain housing in top and bottom curtain channels on air conditioner.

**Top view**

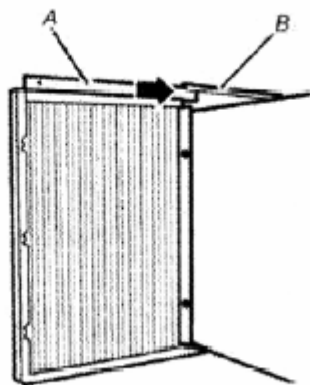

A. Curtain housing  
B. Curtain top channel on air conditioner

**Bottom view**

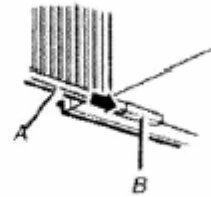

A. Curtain housing  
B. Curtain bottom channel on air conditioner

- Extend right-hand curtain outward so you may insert the first screw through the middle hole of the curtain. Using #10 x 1/4" pan-head Phillips screw, screw curtain to middle hole in air conditioner cabinet.

**NOTE:** This screw is required to correctly attach curtain (top to bottom) to the air conditioner cabinet.

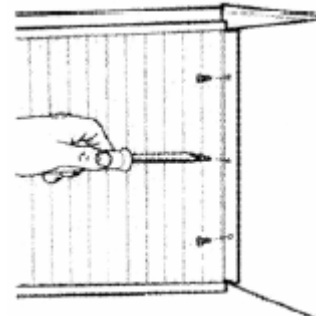

- While the right-hand curtain is still extended, insert #10 x 1/4" pan-head Phillips screws into the top and bottom slots of curtain. Screw curtain to the top and bottom holes in the air conditioner cabinet.
- Slide the curtain housing into the curtain channels as far as it will go.
- Repeat above steps for the left hand curtain.

### Attach foam adhesive seal

Attach foam adhesive seal along the bottom of the curtain bottom channel.

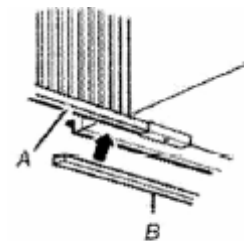

A. Curtain housing  
B. Foam adhesive seal

## Install Cabinet into Window

- Handle air conditioner gently.
  - Be sure your air conditioner cabinet does not fall out of the opening during installation or removal.
  - The place where the power cord exits the air conditioner should be no more than 4 ft (122 cm) from a grounded 3 prong outlet.
  - Do not block the louvers on the front panel.
  - Do not block the louvers on the outside of the air conditioner.
1. Center empty cabinet in window. Check that lower rail of air conditioner cabinet is behind and against back side of windowsill. Maintain a firm hold on the air conditioner cabinet. Lower window sash to hold cabinet in place.
  2. Measure the distance between the right-hand side of the cabinet and the inside of the window channel.
  3. Repeat for the left side. Adjust the cabinet until the distance on each side is the same.

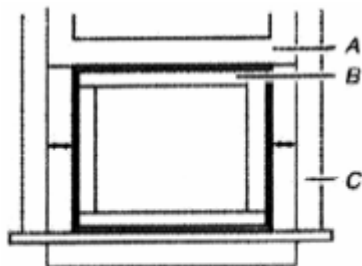

A. Window sash  
B. Empty cabinet  
C. Window channel

4. use a 3/16" drill bit to drill 4 starter holes 3/8" deep- through the 4 holes in the cabinet and into the windowsill.
5. Attach cabinet to windowsill with 4 - # 10 x 1/2" pan-head Phillips screws.

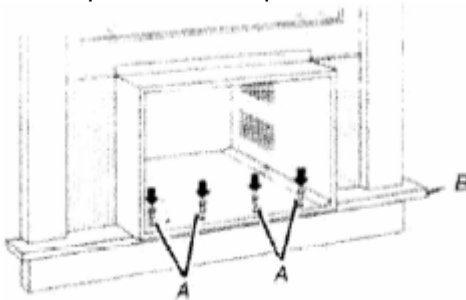

6. Check that air conditioner cabinet is tilted to the outside so that water will run to the outside.

## Attach Side Curtains to Window Frame

1. Pull Left-hand curtain out until it fits into window channel. Use a 3/32" drill bit to drill a starter hole through the hole in the curtain housing and into the lower window sash.

### Front View

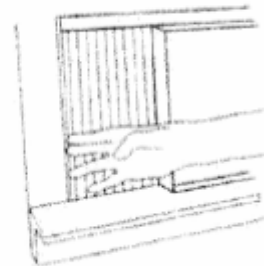

### Top View

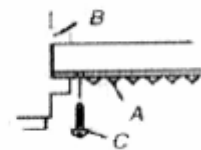

A. Left-hand curtain  
B. Window channel  
C. #10 x 3/4" round-head screw

2. Insert one of the #10 x 3/4" round-head screws through the threaded hole in the top of the curtain.

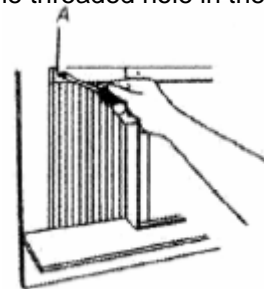

A. #10 x 3/4" round-head screw

3. Repeat for right-hand curtain.

## Attach support Brackets

1. Attach support brackets to the cabinet by aligning the holes in the bracket with the holes in the cabinet.

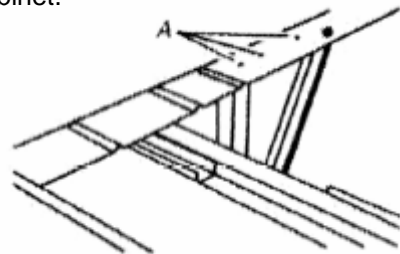

A. Align holes in cabinet with holes in support bracket.

- Using #10 x 7/8" pan-head Phillips screws, attach bracket to cabinet. Repeat for other bracket.
- Turn the adjustment bolt for each bracket until the bolt touches the wall.
- Turn the locking nut on adjustment bolt to lock in positions.

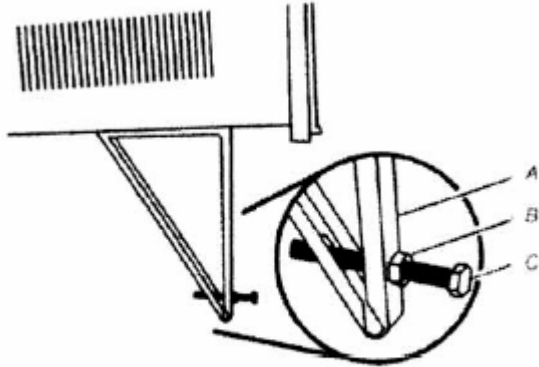

A. Support bracket  
B. Locking nut  
C. Adjustment bolt

### Complete Installation

- Insert seal behind the top of the lower window sash and against the glass of the upper window.
- Place one window-lock bracket on top of lower window and against upper window sash on each side of window.
- Use a 3/32" drill bit to drill starter holes through the holes in each bracket into the window sash.
- Attach both window-lock brackets to window sash with a #10 x 3/4" round-head screw to secure window in place.

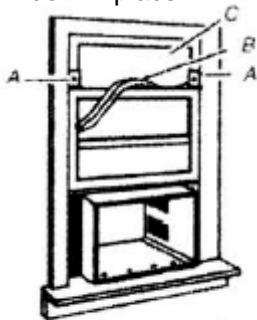

A. Window lock brackets  
B. Window rail seal  
C. Upper window glass

### Final Installation

#### NOTE:

- Make sure the free end of the ground wire is outside of the cabinet.

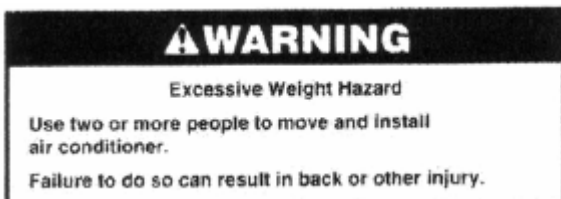

- Insert air conditioner into cabinet.

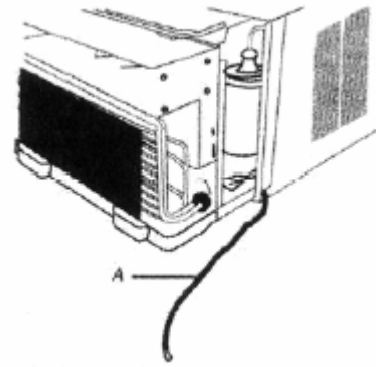

- Connect green ground wire to cabinet base with ground screw. Position ground wire pointing straight up. Put excess ground wire between coil and air conditioner cabinet.
- Push Front panel straight on and then lower it slightly to lock it into place.
- Using 2 # 10 x 3/8" round head screws, attach bottom of front panel.

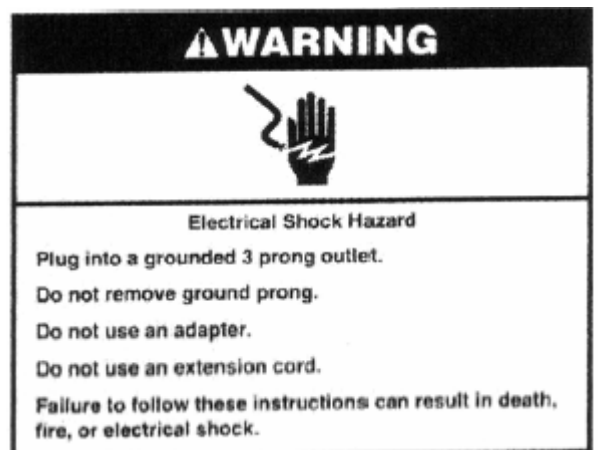
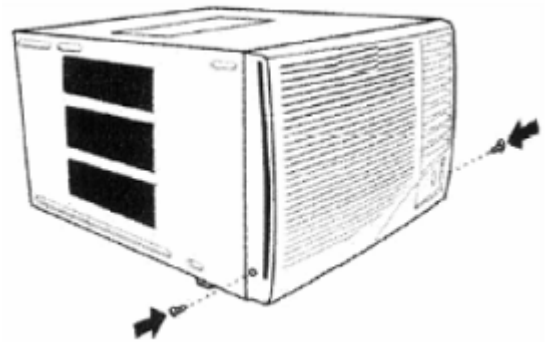

## Through-the-Wall Cabinet Installation

### NOTES:

- Handle air conditioner gently.
- Be sure your air conditioner does not fall out of the opening during installation or removal.
- The place where the power cord exits the air conditioner should be no more than 4 ft (122cm) from a grounded 3 prong outlet.
- It is the customer's responsibility and obligation to have this product installed by a qualified technician familiar with through-the-wall room air conditioner installations.
- Do not block the louvers on the front panel.
- Do not block the louvers on the outside of the air conditioner.

### Option 1 – Wood, Metal or Plastic molding

When using a wood, metal or plastic molding, the wood frame should line up with inside wall as shown,

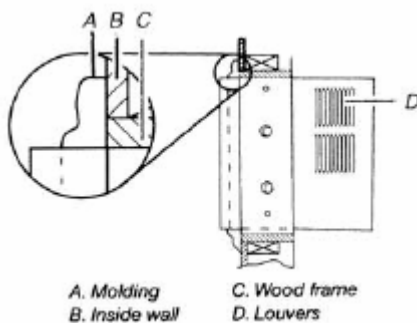

### Option 2 – Plastered wall with no molding

If the plastered wall is to be flush with the cabinet and no molding used, the wood frame must be set  $\frac{1}{2}$ " (913mm) into the inside wall.

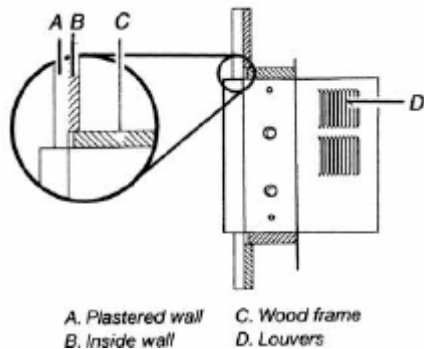

### Install Wood Frame

1. Construct wood frame. See "Location Requirements" for dimensions.
2. Measure outside width and height of frame to determine wall opening dimensions.
3. Cut opening through the wall. Remove and save insulation.
  - Dimension for depth depends on wall thickness and type of molding.
  - Do not block louvers in air conditioner cabinet.

- Use 1" (2.5cm) or thicker lumber for wood frame.
4. Apply wood preservative to the outside exposed surfaces.

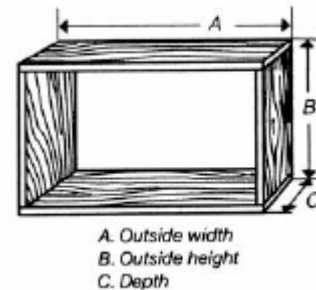

5. Insert the frame in the wall opening. Square and level frame.
6. Attach frame securely to the wall.

### INSTALL CABINET INTO WOOD FRAME

1. Remove top channel and both side channels using a  $\frac{1}{4}$ " nut driver or socket wrench. Discard top channel and both side channels.

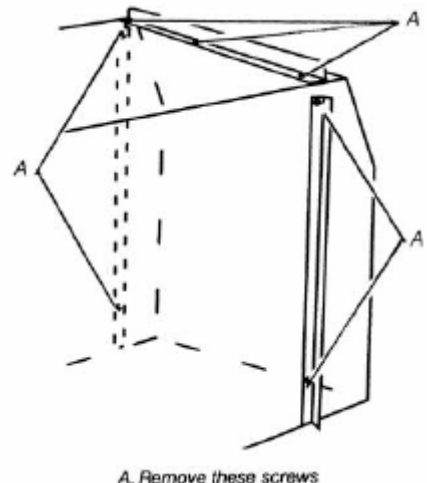

2. Insert cabinet into the framed wall opening. The top of the cabinet should extend  $\frac{3}{4}$ " (19.1 mm) into the room. If there is trim, the cabinet should extend  $\frac{3}{4}$ " (19.1mm) past the trim.

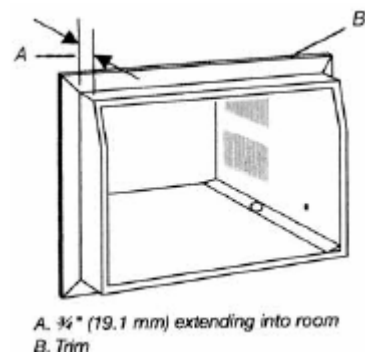

- Use a level to check that the unit is level side to side.

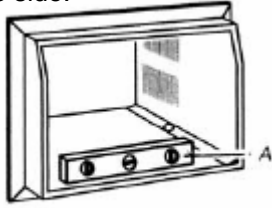

A. Level

- Check that air conditioner cabinet is tilted to the outside so that water will run to the outside.
- Reuse the insulation to seal opening between cabinet and frame.
- Use existing holes in sides and top of cabinet and 7 #10 x 1" wood screws (not provided) to attach cabinet to frame.
 

**NOTE:** Do not over-tighten screws or cabinet will distort and provide a poor seal between cabinet and air conditioner.
- Caulk all outside wall openings around cabinet.

#### Complete Installation

- Insert seal behind the top of the lower window sash and against the glass of the upper window.
- Place one window-lock bracket on top of lower window and against upper window sash on each side of window.
- Use a 3/32" drill bit to drill starter holes through the holes in each bracket into the window sash.
- Attach both window-lock brackets to window sash with a #10 x 3/4" round-head screw to secure window in place.

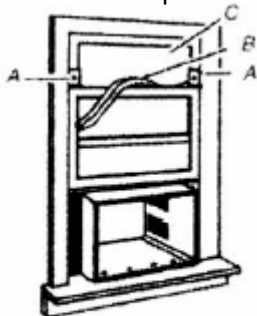

A. Window lock brackets  
B. Window rail seal  
C. Upper window glass

#### Final Installation

##### NOTE:

- Make sure the free end of the ground wire is outside of the cabinet.

**⚠ WARNING**

**Excessive Weight Hazard**

Use two or more people to move and install air conditioner.

Failure to do so can result in back or other injury.

- Insert air conditioner into cabinet.

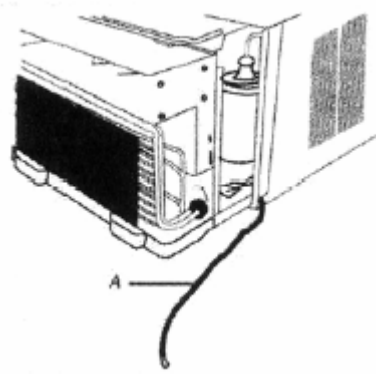

- Connect green ground wire to cabinet base with ground screw. Position ground wire pointing straight up. Put excess ground wire between coil and air conditioner cabinet.
- Push Front panel straight on and then lower it slightly to lock it into place.
- Using 2 # 10 x 3/8" round head screws, attach bottom of front panel.

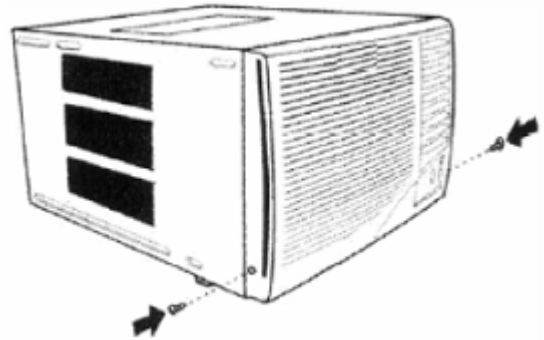

**⚠ WARNING**

**Electrical Shock Hazard**

Plug into a grounded 3 prong outlet.

Do not remove ground prong.

Do not use an adapter.

Do not use an extension cord.

Failure to follow these instructions can result in death, fire, or electrical shock.

## AIR CONDITIONER USE

Operating your air conditioner properly helps you obtain the best possible results. This section explains proper air conditioner operation

### IMPORTANT:

- If you turn off the air conditioner, wait at least 3 minutes before turning it back on. This prevents the air conditioner from blowing a fuse or tripping a circuit breaker.
- Do not try to operate your air conditioner in the cooling mode when outside temperature is below 65°F. The inside evaporator coil will freeze up, and the air conditioner will not operate properly.

### NOTE:

In the event of a power failure, your air conditioner will operate at the previous settings when the power is restored.

### Touch Control Panel

Lights next to the touch pads on the air conditioner control panel indicate the selected settings.

The display always shows the room temperature except when setting the Set temperature or the Timer.

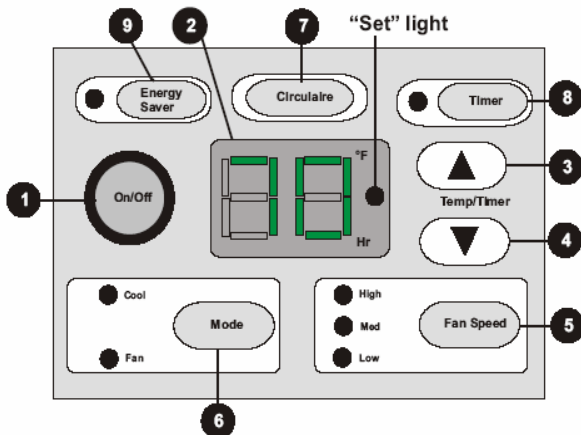

### Model WAC18230R

The display always shows the room temperature except when setting the Set temperature or the Delay timer.

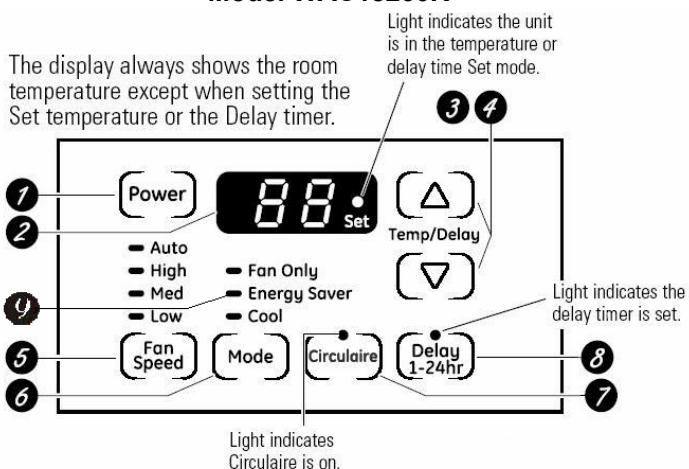

## Model WAC24230R

### Air Conditioner Controls

1. **Power pad** – Turns the air conditioner on and off. When turned on, the display will show the room temperature.
2. **Display** – Shows the room temperature or time remaining on the Delay timer. Shows the **Set** temperature while setting the temperature in **Cool** or **Energy Saver** modes. The **Set** light will turn on while setting.  
**NOTE:** The display will change to show the room temperatures after settings have been made. To recall the **Set** temperature, press the **Temp Increase** or **Decrease** pads.
3. **Increase “▲” pad** – Used to increase set temperature when in **Cool** or **Energy Saver** mode. The **Set** light will turn on while setting. Used to increase the delay time when using the **Timer** function.
4. **Decrease “▼” pad** – Used to decrease set temperature when in **Cool** or **Energy Saver** mode. The **Set** light will turn on while setting. Used to decrease the delay time when using the **Timer** function.
5. **Fan Speed pad** – Used to select the fan speed. The lights marked “**High**”, “**Med**”, or “**Low**” will illuminate to indicate which fan speed is selected.
6. **Mode pad** – Used to select between **Fan** only or **Cool** mode of operation. In the **Fan** only mode, since **Fan** only settings do not provide cooling, a **Set** temperature can not be entered. The display will indicate the room temperature.
7. **Circulaire pad** – Used to turn on the side-to-side air circulation. For fixed side-to-side air direction, turn on until the desired air direction is obtained, then turn off.
8. **Timer/Delay pad** – Used to select the amount of time before the air conditioner turns off (when on), or the amount of time before the air conditioner turns on (when off). Programmable in 1 hour increments from 1 to 24 hours.

### How to set the Timer:

#### Delayed “ON”;

Air Conditioner must be off.

Press the **Timer/Delay** button.

The **Timer/Delay** light will turn on and the display will indicate the number of hours before the air conditioner will turn on. To change the time before turn on, press the **Increase “▲”** or **Decrease “▼”** pads until the desired number of hours before turn on is reached (1 to 24 hrs).

### Delayed "OFF":

Air Conditioner must be on.

Press **Timer/Delay** button.

The **Timer/Delay** light will turn on and the display will indicate the number of hours before the air conditioner will turn off. To change the time before turn off, press the **Increase "▲"** or **Decrease "▼"** pads until the desired number of hours before turn on is reached (1 to 24 hrs).

To review the amount of time remaining on the timer, press the **Timer/Delay** pad one time. If you desire to increase or decrease the amount of time remaining, use the **Increase "▲"** or **Decrease "▼"** pads to set a new time.

To cancel the **Timer**, press the **Timer/Delay** pad until the **Timer/Delay** light extinguishes.

### 9. Energy Saver pad – used to control the fan.

When the **Energy Saver** pad is pressed, the **Energy Saver** light comes on, and the fan will cycle on and off with the compressor. This results in wider variations of room temperature and humidity. Normally used when the room is unoccupied.

**NOTE:** The fan may continue to run for a short period of time after the compressor cycles off.

Pressing the **Energy Saver** pad a second time turns the **Energy Saver** mode off, and the fan runs all the time, while the compressor cycles on and off.

### 10. Fan Only Mode:

Use the **Fan Only Mode** at **Low, Med** or **High** fan speed to provide air circulation and filtering without cooling, a **Set** temperature cannot be entered. The room temperature will appear in the display.

**NOTE:** Auto Fan Speed cannot be used when in the **Fan Only Mode**.

### 11. Auto Fan Speed:

Set to **Auto** fan speed for the fan speed to automatically set to the speed needed to provide optimum comfort settings with the set temperature.

If the room needs more cooling, the fan speed will automatically increase. If the room needs less cooling, the fan speed will automatically decrease.

**NOTE:** Auto Fan Speed cannot be used when in the **Fan Only Mode**.

## REMOTE CONTROL OPERATION

### NOTE:

- Be sure that there are no obstructions between the receiver and the remote controller.
- Do not drop or throw the remote controller.
- Do not let any liquid in the remote controller or put the remote controller under direct sunlight or any place where it is very hot.
- Replace two AAA batteries once a year, or as required.

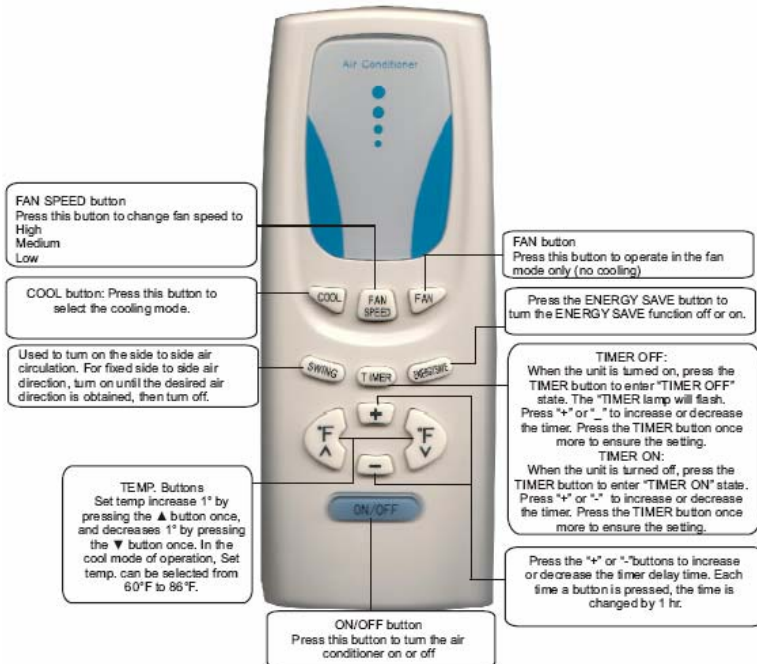

Model WAC18230R



Model WAC24230R

---

## Manual Controls

Features and appearance may vary.

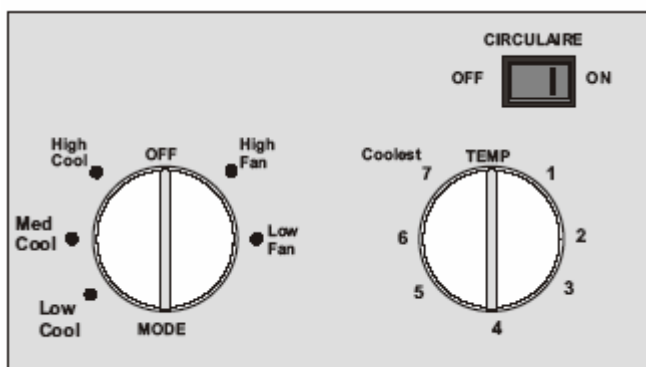

Model WAC24230M

### Controls

The air conditioner controls are located behind the control panel doors. Press to open and close the door.

#### Mode Control

##### High Cool, Med Cool and Low Cool

Provide cooling with different fan speeds.

**High Fan** and **Low Fan** settings provide air circulation and filtering without cooling.

**NOTE:** if you move the mode control from a cool setting to **OFF** or to a fan setting, wait at least 3 minutes before switching back to a cool setting.

#### Cooling Descriptions

**For Normal Cooling** – Select **High Cool** or **Med Cool** with the **TEMPERATURE** control at midpoint.

**For Maximum Cooling** – Select **High Cool** with the **TEMPERATURE** control at the highest number available on you knob.

**For Quieter & Nighttime Cooling** – Select **Low Cool** with the **TEMPERATURE** control at midpoint.

#### TEMP Control

The **TEMP** control is used to maintain the room temperature. The compressor will cycle off and on to keep the room at the same level of comfort. When you turn to the knob to a higher number, the indoor air will become cooler. Turn the knob to a lower number and the indoor air will become warmer.

#### CIRCULAIRE

For continuous side-to-side air circulation, set the Circulair switch to **ON**.

For fixed side-to-side air direction, set the **Circulaire** switch to **ON** until the desired air direction is obtained, then move it to **OFF**.

---

## AIR CONDITIONER CARE

Your new air conditioner is designed to give you many years of dependable service. This section tells you how to clean and care for your air conditioner properly. Call your local authorized dealer for an annual checkup. Remember, the cost of this service call is your responsibility.

#### Cleaning the Air Filter

The air filter is removable for easy cleaning. A clean filter helps remove dust, lint, and other particles from the air and is important for best cooling and operating efficiency. Check the filter every 2 weeks to see whether it needs cleaning.

**NOTE:** Do not operate the air conditioner without the filter in place.

1. Turn off the air conditioner.
2. Remove air filter by sliding filter out from either side of unit.

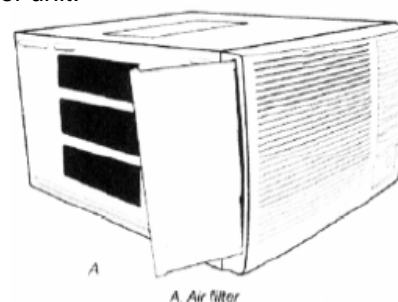

- Use a vacuum cleaner to clean air filter. If air filter is very dirty, wash it in warm water with a mild detergent. Do not wash air filter in the dishwasher or use any chemical cleaners. Air dry filter completely before replacing to ensure maximum efficiency.
- Replace air filter by sliding filter back into either side of unit.

---

#### Cleaning the Front Panel

- Turn off the air conditioner
- Remove the air filter and clean it separately. See Cleaning the Air Filter.
- Wipe the front panel with a soft damp cloth.
- Air dry front panel completely.

#### Repairing Paint Damage

Check once or twice a year for paint damage. This is very important, especially in areas near oceans or where rust is a problem. If needed, Touchup with a good grade enamel paint.

**NOTE:** To reduce paint damage during the winter, install a heavy duty cover over the air conditioner cabinet.

---

#### Annual Maintenance

Your air conditioner needs annual maintenance to help ensure steady, top performance throughout the year. Call your local authorized dealer to schedule an annual checkup. The expense of an annual inspection is your responsibility.

---

### TROUBLESHOOTING

Before calling for service, try the suggestions below to see whether you can solve your problem without outside help.

Air conditioner will not operate

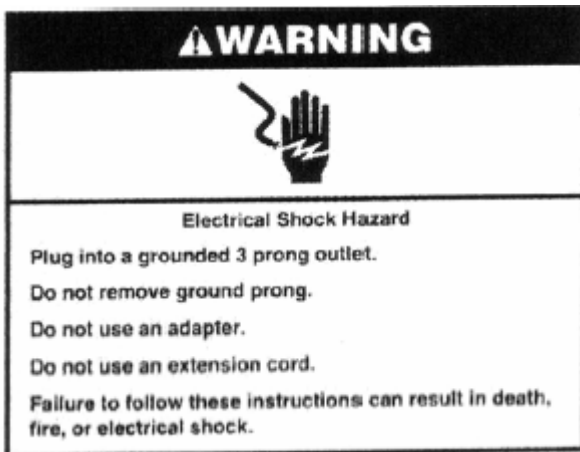

**The power supply cord is unplugged.** Plug into a grounded 3 prong outlet. See "Electrical Requirements".

**The power supply cord has tripped (Reset button has popped out).** Press and release RESET (listen for click; Reset button will latch and remain in) to resume operation.

**A household fuse has blown, or a circuit breaker has tripped.** Replace the fuse or reset the circuit breaker. If the problem continues, call an electrician. See "Electrical Requirements".

**Depending on model, the Power button has not been pressed or the Fan control is turned to OFF.** Press POWER or turn the Fan control to an active setting.

**The local power has failed.** Wait for power to be restored.

---

#### Air conditioner blows fuses or trips circuit breakers

**Too many appliances are being used on the same circuit.** Unplug or relocate appliances that share the same circuit.

**Time-delay fuse or circuit breaker of the wrong capacity is being used.** Replace with a time-delay fuse or circuit breaker of the correct capacity. See "Electrical Requirements".

**An extension cord is being used.** Do not use an extension cord with this or any other appliance.

**You are trying to restart the air conditioner too soon after turning the unit off.** Wait at least 3 minutes after turning the unit off before trying to restart the air conditioner.

---

#### Air Conditioner power supply cord trips (Reset button pops out)

**Disturbances in your electrical current can trip (Reset button will pop out) the power supply cord.** Press and release RESET (listen for click; Reset button will latch and remain in) to resume operation.

**Electrical overloading, overheating, pinched cord can trip (Reset button will pop out) the power supply cord.**

After correcting the problem, press and release RESET (listen for click; Reset button will latch and remain in) to resume operation.

**NOTE:** a damaged power supply cord must be replaced with a new power supply cord obtained

from the product manufacturer and must not be repaired.

---

**Air conditioner seems to run too much**

---

**The current air conditioner replaced an older model.** The use of more efficient components may cause the air conditioner to run longer than an older model, but the total energy consumption will be less. Newer air conditioners do not emit the blast of cold air you may be accustomed to from older units, but this is not an indication of lesser cooling capacity or efficiency. Refer to the efficiency rating (EER) and capacity rating (in BTU/hr.) marked on the air conditioner.

**The air conditioner is in a heavily occupied room, or heat-producing appliances are in use in the room.** Use exhaust vent fans while cooking or bathing and try not to use heat producing appliances during the hottest part of the day. A higher capacity air conditioner may be required, depending on the size of the room being cooled.

---

**Air Conditioner cycles on and off too much, or does not cool/heat room in cooling/heating mode**

---

**The mode of Fan control is set to Power Saver (on some models).** Use Power Saver only when you are asleep or away from home, since the fan does not circulate the room air continuously. Use Low Cool, High Cool, or Turbo Cool for your best comfort.

**The air conditioner is not properly sized for your room.**

Check the cooling capabilities of your room air conditioner. Room air conditioners are not designed to cool multiple rooms.

**The filter is dirty or obstructed by debris.** Clean the filter.

**The inside evaporator and outside condenser coils are dirty or obstructed by debris.** See "Annual Maintenance."

**There is excessive heat or moisture (open container cooking, showers, etc.) in the room.** Use a fan to exhaust heat or moisture from the room. Try not to use heat-producing appliances during the hottest part of the day.

**The louvers are blocked.** Install the air conditioner in a location where the louvers are free from curtains, blinds, furniture, etc.

**The outside temperature is below 65°F (18°C).** Do not try to operate your air conditioner in the cooling mode when the outside temperature is below 65°F (18°C).

**The temperature of the room you are trying to cool is extremely hot.** Allow extra time for the air conditioner to cool off a very hot room.

**Windows or doors to the outside are open.** Close all windows and doors.

**The Vent control is set to OPEN (on some models).** Push the Vent control to CLOSED for maximum cooling and/or heating.

**The temperature set point or Thermostat control is not at a cool enough setting.** Adjust the temperature set point to a cooler setting by pressing the minus button to reduce the temperature or adjust the Thermostat control to a cooler setting by turning the knob clockwise. Turn the Fan control to HIGH or Turbo Cool.

---

**Temperature on display does not match room temperature**

---

**When the compressor and fan motor turn off during Power Saver mode, or after you turn off the unit, a lower temperature reading than the actual room temperature may be displayed for a short period of time.** This lower temperature reading is caused by the temperature sensor being located close to the cold evaporator coil. The actual room temperature will display within a few minutes.

---

**Water drips from cabinet into your house**

---

**The air conditioner is not properly leveled.** The air conditioner should slope slightly downward toward the outside. Level the air conditioner to provide a downward slope toward the outside to ensure proper drainage. See the Installation instructions.

**NOTE:** Do not drill a hole into the bottom of the metal base and condensate pan.

## TECHNICAL SPECIFICATIONS

<b>MODEL</b>	<b>WAC18230R</b>	<b>WAC24230R</b>	<b>WAC24230M</b>
<b>BTU Cooling</b>	<b>18,000</b>	<b>24,000</b>	<b>24,000</b>
<b>BTU Heating</b>	<b>N/A</b>	<b>N/A</b>	<b>N/A</b>
<b>EER</b>	<b>9.7</b>	<b>8.5</b>	<b>8.5</b>
<b>Dehumidification (Pints/Hour)</b>	<b>4.6</b>	<b>6.5</b>	<b>6.5</b>
<b>Airflow (cfm)</b>	<b>459</b>	<b>618</b>	<b>618</b>
<b>Voltage</b>	<b>208/230 VAC</b>	<b>208/230 VAC</b>	<b>208/230 VAC</b>
<b>Amps Cooling</b>	<b>12.57</b>	<b>13.1/12.1</b>	<b>13.1/12.1</b>
<b>Amps Heating</b>	<b>N/A</b>	<b>N/A</b>	<b>N/A</b>
<b>Watts Cooling</b>	<b>1810 / 1850</b>	<b>2710 / 2740</b>	<b>2710 / 2740</b>
<b>Watts Heating</b>	<b>N/A</b>	<b>N/A</b>	<b>N/A</b>
<b>Plug Type</b>	<b>Type C</b>	<b>Type C</b>	<b>Type C</b>
<b>Power Cord Rating (amps)</b>	<b>20</b>	<b>20</b>	<b>20</b>
<b>Power Cord Type</b>	<b>LCDI</b>	<b>LCDI</b>	<b>LCDI</b>
<b>Power Cord Length</b>	<b>6'</b>	<b>6'</b>	<b>6'</b>
<b>Refrigerant</b>	<b>R22</b>	<b>R22</b>	<b>R22</b>
<b>Refrigerant Charge (oz. / lbs)</b>	<b>27.84 / 1.74</b>	<b>33.44 / 2.09</b>	<b>33.44 / 2.09</b>
<b>Sound Level (Inside / Outside) dba (MAX)</b>	<b>56 / 61</b>	<b>56 / 61</b>	<b>56 / 61</b>
<b>4 Way Air Adjustment</b>	<b>YES</b>	<b>YES</b>	<b>YES</b>
<b>2 Way Air Swing</b>	<b>YES</b>	<b>YES</b>	<b>YES</b>
<b>Air Discharge</b>	<b>SIDE</b>	<b>SIDE</b>	<b>SIDE</b>
<b>Motor Type</b>	<b>Ball Bearing</b>	<b>Ball Bearing</b>	<b>Ball Bearing</b>
<b>Motor Capacitor</b>	<b>7 µfd</b>	<b>7 µfd</b>	<b>7 µfd</b>
<b>Controls</b>	<b>Remote</b>	<b>Remote</b>	<b>Mechanical</b>
<b>Ambient Operating Temperature</b>	<b>64°F TO 109°F</b>	<b>64°F TO 109°F</b>	<b>64°F TO 109°F</b>
<b>Cabinet Size (Inches)</b>			
<b>Width</b>	<b>26"</b>	<b>26"</b>	<b>26"</b>
<b>Depth</b>	<b>27 7/8"</b>	<b>30 1/2"</b>	<b>30 1/2"</b>
<b>Height</b>	<b>16 7/8"</b>	<b>17"</b>	<b>17"</b>
<b>Window Opening</b>	<b>30" – 46"</b>	<b>30" – 46"</b>	<b>30" – 46"</b>
<b>Thru Wall Max Thickness</b>	<b>8 1/2"</b>	<b>8 1/2"</b>	<b>8 1/2"</b>
<b>Weight/Lbs (Gross / Net)</b>	<b>163 / 150</b>	<b>183 / 165</b>	<b>183 / 165</b>
<b>Approvals</b>	<b>UL/CUL</b>	<b>UL/CUL</b>	<b>UL/CUL</b>

## **WARRANTY**

International Refrigeration Products warrants that the product supplied is free from defects in material and workmanship. This warranty is valid as long as this product is properly handled, installed, operated and serviced in accordance with the Installation and Operating Instructions shipped with this unit, and the warranty card is completed and mailed no later than 30 days after date of purchase. All warranty claims must be made within one (1) year (five (5) years for compressor) from date of purchase (unless national regulations require a longer registration period).

This warranty provides free replacement of defective parts only. Labor and replacement parts as a result of normal wear and tear are not covered under this warranty.

Additional claims are excluded, unless required by national regulations. International Refrigeration Products Inc. is not responsible for incidental, consequential, direct, or indirect damages or expenses relating to the use of, or the inability to use the product for any purpose. Other implied warranties are excluded.

This constitutes International Refrigeration Products warranty obligation and replaces any and all prior warranties for this product.

**INTERNATIONAL REFRIGERATION PRODUCTS INC.**  
11325 Nations Ford Rd., Charlotte, NC 28134-8393  
(704) 504-8590 Phone (704) 504-3023 Fax

Copyright 2006 IRP Inc.

950-0011