

This Owner's Manual is provided and hosted by [Appliance Factory Parts](http://Appliance Factory Parts).



# THERMALZONE WAC12230MB Owner's Manual

[Shop genuine replacement parts for THERMALZONE  
WAC12230MB](#)



[Find Your THERMALZONE Air Conditioner Parts - Select From 27 Models](#)

----- Manual continues below -----



# WINDOW AIR CONDITIONER INSTALLATION AND OPERATION



CATALOG NO.	PRODUCT CODE
WAC12115RB	420-0028



CATALOG NO.	PRODUCT CODE
WAC12230MB	420-0027
WAC12115MB	420-0029

## TABLE OF CONTENTS

AIR CONDITIONER SAFETY.....	2
INSTALLATION REQUIREMENTS.....	3
ELECTRICAL REQUIREMENTS.....	4
INSTALLATION INSTRUCTIONS.....	6
THRU-WALL INSTALLATION INSTRUCTIONS.....	10
AIR CONDITIONER USE.....	12
AIR CONDITIONER CARE.....	16
TROUBLESHOOTING.....	16
SPECIFICATIONS.....	18
WARRANTY.....	19

## TECHNICAL SUPPORT

IF YOU NEED TECHNICAL SUPPORT, PLEASE CALL (705) 504-8590 BETWEEN THE HOURS OF 8:00 A.M. and 5:00 P.M. EST.  
PLEASE HAVE THE MODEL NUMBER AND SERIAL NUMBER OF YOUR EQUIPMENT AVAILABLE WHEN YOU CALL.

## AIR CONDITIONER SAFETY

Your safety and the safety of others is very important  
We have provided many important safety messages in this manual and on your appliance.  
Always read and follow all safety instructions.



This is the safety alert symbol.  
This symbol alerts you to potential hazards that can kill or hurt you or others.

All safety messages will follow the safety alert symbol and the word "DANGER" or "WARNING".

These words mean:



You can be seriously injured if instructions are not followed.



Bodily injury or damage to personal property may occur if instructions are not followed.

All safety messages will tell you what the potential hazard is, tell you how to reduce the chance of injury, and tell you what can happen if the instructions are not followed.

## IMPORTANT SAFETY INSTRUCTIONS

**WARNING:** To reduce the risk of fire, electrical shock, or injury when using your air conditioner, follow these basic precautions:

- Plug into a grounded 3 prong outlet.
- Do not remove ground prong
- Do not use an adapter.
- Do not use an extension cord
- Unplug air conditioner before servicing
- Use two or more people to move and install air conditioner.

## SAVE THESE INSTRUCTIONS

## INSTALLATION REQUIREMENTS

Gather the required tools and parts before starting installation. Read and follow the instructions provided with the tools listed Here.

### Tools Needed

- Flat-Blade and Phillips screwdrivers
- Level
- Tape measure
- Drill and 3/16" or smaller bit

### Through-the-wall installation

In addition to the tools listed above, the following tools are Needed for through-the-wall installations:

- Saw
- Wood Preservative
- Caulk
- 1" (2.5cm) or thicker lumber
- 7 - #10 x 1" wood screws

### Parts Supplied (on some models)

Check that all parts are included in the parts package.

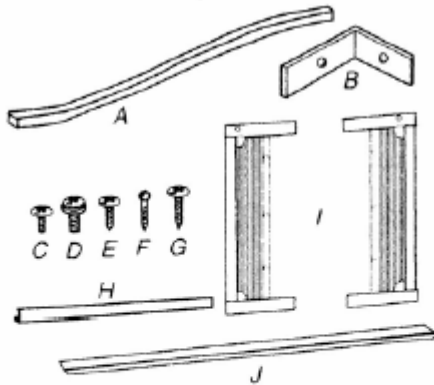

- A. Foam window sash seal
- B. Window lock brackets (2)
- C. #10 x 1/2" pan-head Phillips screws (6)
- D. #10 x 3/8" washer-head Phillips screws (4)
- E. #10 x 1/2" pan-head Phillips screws (4)
- F. #10 x 3/4" round-head screws (6)
- G. #10 x 7/8" pan-head Phillips screws (4)
- H. Top channel
- I. Side curtains (2)
- J. Foam seal

**IMPORTANT:** Observe all governing codes and ordinances. Check the location where air conditioner will be installed. Proper Installation is your responsibility. Make sure you have everything necessary for correct installation.

The location should provide:

- Grounded electrical outlet within 4 ft (122 cm) of where the power cord exits the air conditioner. **NOTE: Do not use an extension cord.**
- Free movement of air in room to be cooled
- A large enough opening for the air conditioner

**NOTE: Cabinet louvers must not be obstructed. Air must be able to pass freely through the cabinet louvers.**

## Window Installation

Window opening measurements:

- 27" min to 38" max (68.6 cm to 95.5cm) opening width.
- 16 1/4" min. (41.3 cm) opening height.

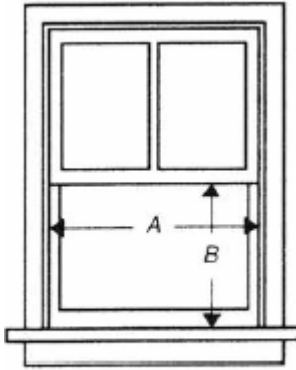

A. 27" min. (68.6 cm)  
B. 16 1/4" min. (41.3 cm)

## Through-the wall installation

The wall opening measurements should be:

- A = Height: 16" (40.6cm) plus twice the thickness of the wood used to build the frame.
- B = Width: 22 5/8" (57.5 cm) plus twice the thickness Of the wood used to build the frame.
- C = Wood thickness.

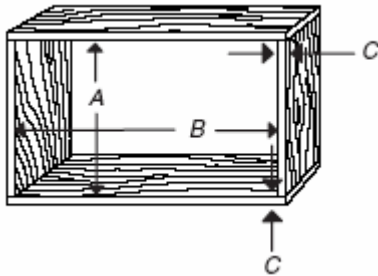

## ELECTRICAL REQUIREMENTS

# ⚠ WARNING



### Electrical Shock Hazard

**Plug into a grounded 3 prong outlet.**

**Do not remove ground prong.**

**Do not use an adapter.**

**Do not use an extension cord.**

**Failure to follow these instructions can result in death, fire, or electrical shock.**

Ground wire must be connected to ground screw located in lower right corner of air conditioner when air conditioner is in cabinet.

The electrical ratings for your air conditioner are listed on the model and serial number label. The model and serial number

label is located behind the front panel on the flange below the Control panel area.

Specific Electrical requirements are listed in the chart below. Follow the requirements for the type of plug on the power supply cord.

### Power supply cord

### Wiring requirements

- 115-volt (103.5 min. - 126.5 max.)

- 0-12 amps

- 15-amp time-delay fuse or circuit breaker

- Use on single outlet circuit only.



1/4"  
(0.6 cm)



- 230-volt (207 min. - 253 max.)

- 0-12 amps

- 15-amp time-delay fuse or circuit breaker

- Use on single outlet circuit only.



- 230-volt (207 min. - 253 max.)

- 0-16 amps

- 20-amp time-delay fuse or circuit breaker

- Use on single outlet circuit only.

1/2"  
(1.3 cm)



- 230-volt (207 min. - 253 max.)

- 0-24 amps

- 30-amp time-delay fuse or circuit breaker

- Use on single outlet circuit only.

This unit is equipped with an LCDI (leakage Current Leakage and Interruption) plug as required by US National Electric Code 440.65.

This air conditioner must be grounded. This air conditioner is equipped with a power supply cord having a grounded 3 prong plug. To minimize possible shock hazard, the cord must be plugged into a mating, grounded 3 prong outlet, grounded in accordance with all local codes and ordinances. If a mating outlet is not available, it is the customer's responsibility to have a properly grounded 3 prong outlet installed by a qualified electrical installer.

It is the customer's responsibility to:

- Contact a qualified electrical installer.
- Assure that the electrical installation is adequate and in conformance with National Electrical Code, NNSI/NFPA 70- latest edition, and all local codes and ordinances.

Copies of the standards listed may be obtained from:  
National Fire Protection Association  
One Batterymarch Park  
Quincy, MA 02269

### LCDI Plug and Power Cord

**NOTE:** Your unit's device may differ from the ones shown.

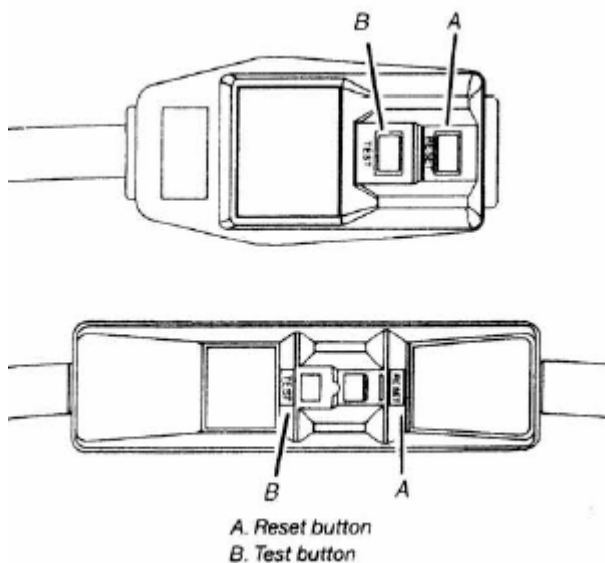

This room air conditioner is equipped with a power supply cord required by UL. This power supply cord contains state-of-the-art electronics that sense leakage current. If the cord is crushed, the electronics detect leakage current, and power will be disconnected in a fraction of a second.

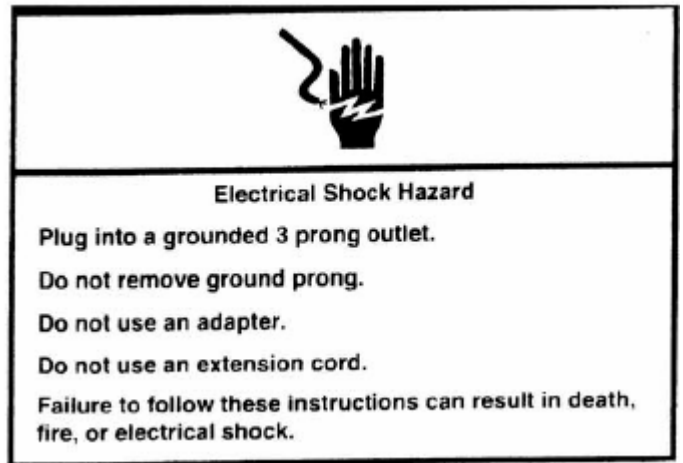

### To test your LCDI Power Cord

1. Plug power supply cord into a grounded 3 prong outlet.
2. Press RESET.
3. Press TEST (Listen for a click; Reset button will trip and pop out).
4. Press and release RESET (Listen for a click; Reset button will Latch and remain in). The power supply cord is ready for operation.

### NOTES:

- The reset button must be pushed for proper operation
- The power supply cord must be replaced if it fails to trip when the test button is pressed or fails to reset
- Do not use the power supply cord as an off/on switch. The power supply cord is designed as a protective device.
- A damaged power supply cord must be replaced with a new power supply cord obtained from the product manufacturer and must not be repaired.
- The power supply cord contains no user serviceable parts. Opening the tamper-resistant case voids all warranty and performance claims.

# INSTALLATION INSTRUCTIONS

## UNPACKING

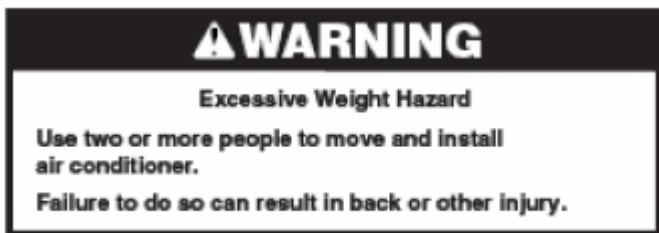

Remove packaging materials

- Remove and dispose or recycle all packaging materials. Remove tape and glue residue from surfaces before turning on the air conditioner. Rub a small amount of liquid dish soap over the adhesive with your fingers. Wipe with warm water and dry.
- Do not use sharp instruments, rubbing alcohol, flammable fluids or abrasive cleaners to remove tape or glue. These products can damage the surface of your air conditioner.
- Handle air conditioner gently.
  1. Remove air conditioner from carton and place it on cardboard.
  2. Remove shipping screws from both sides of cabinet.

3. Remove front panel by removing 2 Phillips head screws on both sides of air conditioner.
4. Remove both knobs from control panel
5. Remove ground screw and ground wire from front of air conditioner base. Save ground screw.

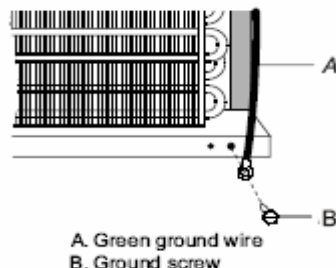

6. Pull on handle to slide air conditioner out of cabinet. Place air conditioner on cardboard

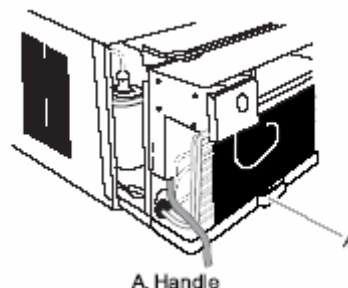

NOTE: Do not lift, push, pull, or remove any expanded polystyrene (foam) from inside the air conditioner. It is NOT packing material.

## Window Installation (on some models)

NOTES:

- Handle air conditioner gently.
- Be sure your air conditioner cabinet does not fall out of the opening during installation or removal.
- The location where the power cord exits the air conditioner should be no more than 4 ft (122cm) from a grounded 3 prong outlet.
- Do not block the louvers on the front panel.
- Do not block the louvers on the outside of the air conditioner.

3. Using 3 - #10 x 3/8" pan-head Phillips screws, attach top channel to air conditioner cabinet.

Attach Top Channel

NOTE: Attach top channel and side curtains to air conditioner cabinet before placing cabinet in window.

1. Locate supplied bag of screws.
2. Place top channel on top of air conditioner cabinet, lining up the 3 holes in top channel with the 3 holes on top of air conditioner cabinet.

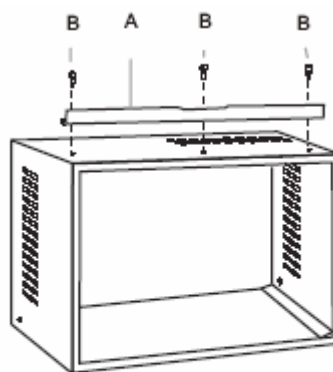

## Attach Side Curtains

1. Locate provided bag of screws
2. Insert top and bottom of right-hand curtain housing in top and bottom curtain guides on air-conditioner cabinet.

### Back View

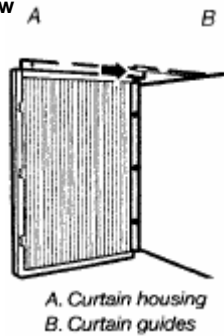

### Bottom View

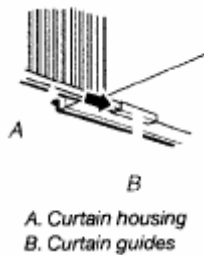

3. Extend right-hand curtain outward so you may insert the first screw through the middle hole of the curtain. Using a #10 x 1/4" pan-head Phillips screw, screw curtain to middle hole in air conditioner cabinet.

**NOTE:** This screw is required to correctly attach curtain (top to bottom) to the air conditioner cabinet.

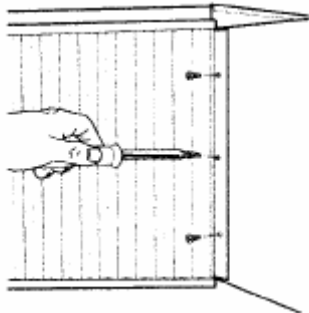

4. While the right-hand curtain is still extended, insert a #10 x 1/4" pan-head Phillips screw into the top and bottom sides of the curtain. Screw curtain to the top and bottom holes in the air conditioner cabinet.

**NOTE:** Some curtains may have 2 slots at each end. You will be able to see a mounting hole through the correct slot.

5. Slide curtain housing into guides as far as it will go.
6. Repeat above steps for left-hand curtain.

## Attach Foam Adhesive Seal

Attach foam adhesive seal along the bottom of the curtain bottom channel.

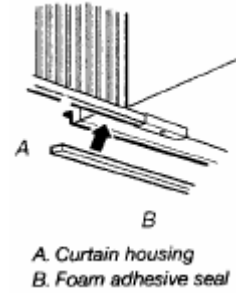

## Install Cabinet into Window

- Handle air conditioner gently
- Be sure your air conditioner cabinet does not fall out of the opening during installation or removal.
- The location where the power cord exits the air conditioner should be no more than 4 ft (122 cm) from a grounded 3 prong outlet.
- Do not block the louvers on the front panel.
- Do not block the louvers on the outside of the air conditioner.

1. Center empty cabinet in window. Check that lower rail of air conditioner cabinet is behind and against back side of windowsill. Maintain a firm hold on the air conditioner cabinet. Lower window sash to hold cabinet in place.
2. Measure the distance between the right-hand side of the cabinet and the inside of the window channel.
3. Repeat for the left side. Adjust the cabinet until the distance on each side is the same.

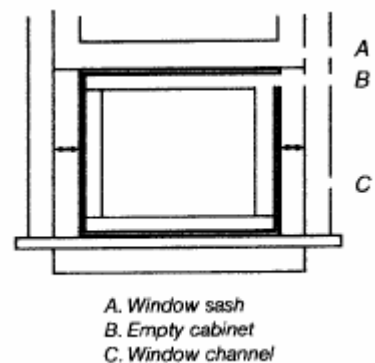

- Use a 3/16" drill bit to drill 3 starter holes 3/8" deep through the 3 holes in the cabinet and into the windowsill.
- Attach cabinet to windowsill with 3 - #10 x 3/8 pan-head Phillips screws.

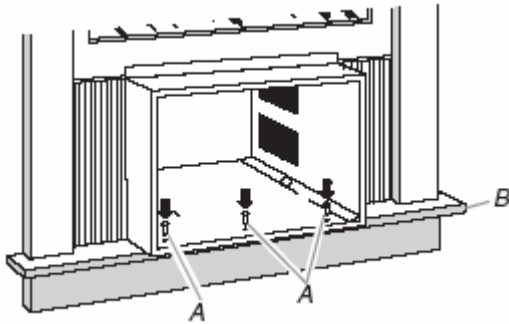

- Check that air conditioner cabinet is tilted to the outside so that water will run to the outside.

#### Attach Side Curtains to Window Frame

- Pull Left-hand curtain out until it fits into window channel. Use a 3/32" drill bit to drill a starter hole through the hole in the curtain housing and into the lower windows sash.

#### Front View

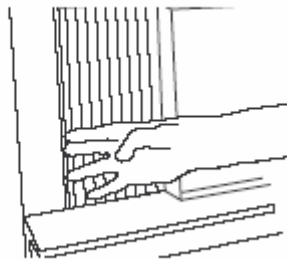

#### Top View

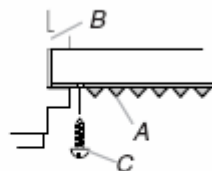

A. Left-hand curtain  
B. Window channel  
C. #10 x 3/4" round-head screw

- Insert one of the #10 x 3/4" round-head screws through hole and into lower window sash. Insert one of the #10 x 3/4" round-head screws through threaded hole in top of curtain.

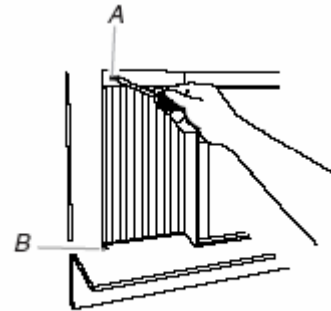

A. #10 x 3/4" round-head screw  
B. Hole for #10 x 3/4" round-head screw

- Repeat for right-hand curtain.

#### Complete Window Installation

- Insert foam seal behind the top of the lower window sash and against the glass of the upper window.
- Place window-lock bracket on top of lower window and against upper window sash.
- Use a 3/32" drill bit to drill a starter hole through the hole in the bracket and into the window sash.
- Attach window-lock bracket to window sash with #10 x 3/4" round-head screw to secure window in place.

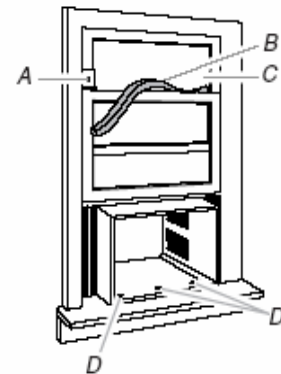

A. Window lock bracket  
B. Foam seal  
C. Upper window glass  
D. #10 x 1/2" pan-head Phillips screws (3)

#### Through-the Wall Cabinet Installation

#### NOTES:

- Handle air conditioner gently
- Be sure your air conditioner cabinet does not fall out of the opening during installation or removal.
- The location where the power cord exits the air conditioner should be no more than 4 ft (122 cm) from a grounded 3 prong outlet.
- Do not block the louvers on the front panel.
- Do not block the louvers on the outside of the air conditioner.
- It is the customer's responsibility and obligation to have this product installed by a qualified technician familiar with through-the-wall room air conditioner installations

## Complete Installation

### ⚠ WARNING

#### Excessive Weight Hazard

Use two or more people to move and install air conditioner.

Failure to do so can result in back or other injury.

**NOTE:** Handle the air conditioner gently.

1. Make sure the free end of the ground wire is outside of the cabinet.
2. Insert air conditioner into cabinet.

**REMEMBER:** Make sure the free end of the ground wire is outside of the cabinet.

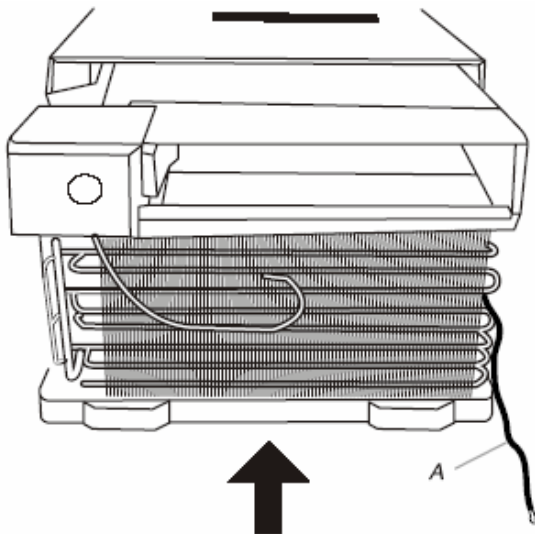

A. Make sure the free end of the ground wire is outside of the cabinet.

### ⚠ WARNING



#### Electrical Shock Hazard

Connect green ground wire to ground screw.

Failure to do so can result in death or electrical shock.

Position ground wire pointing straight up. Put excess ground wire between coil and air conditioner cabinet

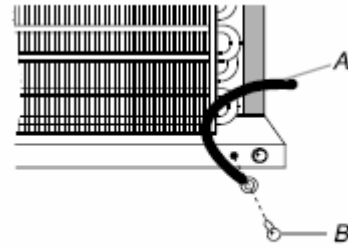

A. Green ground wire

B. Ground screw

4. Remove the 2 front panel screws from air conditioner base.
5. Insert front tabs of front panel into top of cabinet and swing front into place.
6. Attach bottom front of panel with front panel screws. Replace control knobs (on some models).
7. Plug into a grounded 3 prong outlet.
8. Press RESET on the power supply cord plug.

**NOTE:** For through-the-wall installations, if needed, install molding around room side of cabinet.

### ⚠ WARNING



#### Electrical Shock Hazard

Plug into a grounded 3 prong outlet.

Do not remove ground prong.

Do not use an adapter.

Do not use an extension cord.

Failure to follow these instructions can result in death, fire, or electrical shock.

3. Connect green ground wire to cabinet base with ground screw.

## THRU-WALL INSTALLATION INSTRUCTIONS

### INTRODUCTION

This instruction sheet provides guidelines for installing a compact air conditioner through an outside wall.



### CAUTION

Installing an air conditioner through a wall requires extensive carpentry and/or masonry experience. Thru-wall installations performed by inexperienced or unqualified individuals can result in costly damage to home.

### Air Conditioner Dimensions

The following figures show the outside dimensions of air conditioner with chassis installed, and dimensions of the outer case with the chassis removed which need to be measured accurately to determine the size of the opening through the wall.

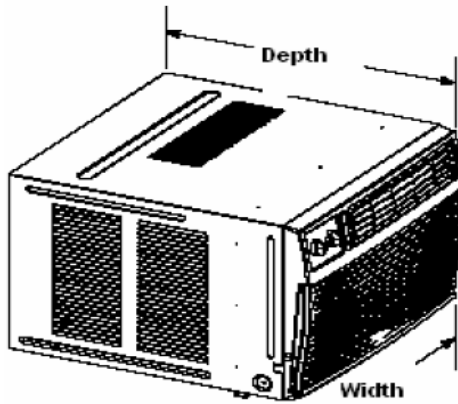

Air Conditioner Dimensions  
(with chassis installed)

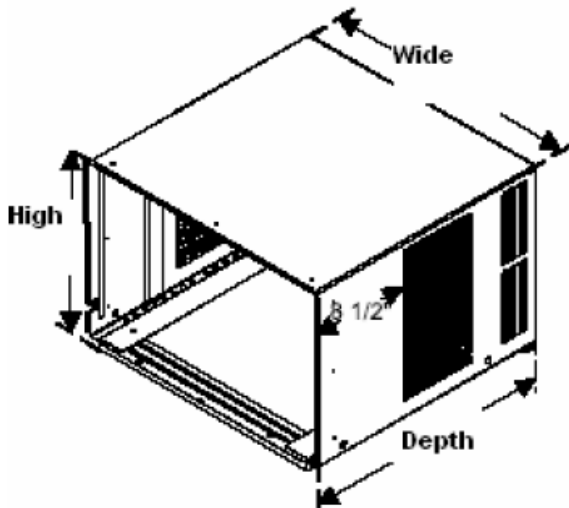

Outer Case dimensions  
(Chassis Removed)



### CAUTION

In order to reinstall the chassis and re-attach the air conditioner front cover, the installed outercase must be square and level from side to side. Use wood shims between sides of case and finished opening - especially where case is secured to opening - to prevent warping or distorting. Check installed case for distortion using carpenter's square.

A finished opening  $\frac{3}{16}$ -inch wider x  $\frac{3}{16}$  higher than the width and height of the unit being installed is recommended. The lower left inside corner of the opening must be within 5 feet of an appropriate electrical outlet.

When wall thickness exceeds 8-1/2 inches, opening must be modified to allow air to enter side louvers on case (see special instructions on back). Do not install air conditioner in walls thicker than 11-3/4\".

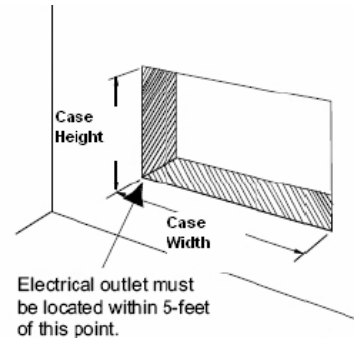

Dimensions of finished opening

### Masonry Construction

See caution under General instructions. In masonry walls, cut or build a finished opening that is  $\frac{3}{16}$ \" wider and  $\frac{3}{16}$ \" higher than outer case dimensions. When case is properly positioned in opening, secure it in place with mortar or concrete nails driven through holes in sides of outer case (shim case and pre-drill holes before securing with nails).

### Brick Veneer or Frame wall Construction

See caution under General instructions. Cut or build rough opening large enough to allow a finished opening  $\frac{3}{16}$ \" wider and  $\frac{3}{16}$ \" higher than outer case dimensions. When case is properly positioned in opening, secure it to framing material with nails or screws driven through holes insides of outer case (shim case and pre-drill holes before securing).

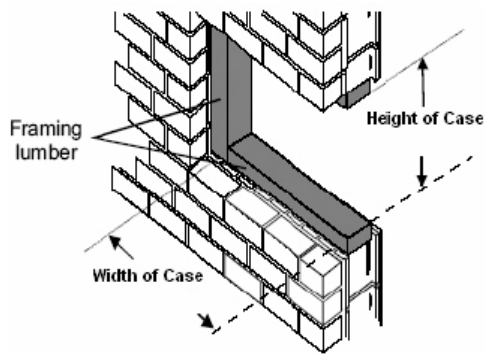

Framed/Finished Opening  
(brick veneer or frame wall construction)

### Placement of Outer Case in Opening

Place outer case in opening, flush against one side of opening. Use carpenter's level and ensure case is level from side to side and has a 3/8" slope from front to back (back of case must be 3/8" lower than front to ensure proper condensate drainage). If needed, use shims to level case (from side to side and to obtain proper back slope).

Front of case must project 3/4 inch (minimum) beyond inside wall in order to attach air conditioner front frame. If framing indoor side of opening with wood molding (or other decorative material), extend outer case 3/4" beyond molding.

When case is properly positioned in opening, use wood shims to fill any gaps between case and finished opening, especially in area where case will be secured to opening. Take care not to warp or distort case when installing shims. For condensate drainage, install drainage cup in drain hole on base-plate of case.

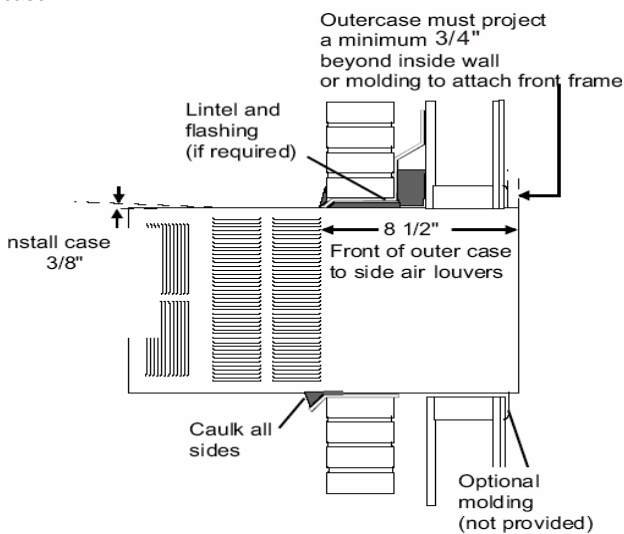

Installed Case  
(brick veneer or frame wall construction shown)

### Installation in Wall Thicker than 8 - 1/2 inches

The side louvers in outer case provide ventilation to air conditioner compressor and fan motor and must not be blocked. When installing unit in a wall over 9 3/8" thick, provisions must be made in wall opening to ensure free air flow to the side louvers. This can be accomplished by chamfering the vertical portions of the outside opening as shown. Ventilation louvers on top of case must not be obstructed. Do not attempt to install unit in walls thicker than 11-3/4 inches.

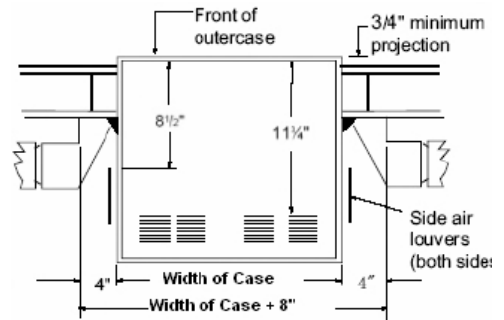

### Chamfering Walls Thicker Than 8 1/2-inches

While operation of all units is similar, controls vary from model to model. Operating Controls section shows control panel of unit purchased and gives detailed information about controls.

### Airflow around Unit

Select the highest fan speed and set temperature control to its coldest position. When the desired temperature is reached, slowly move the temperature control toward a warmer setting until the compressor shuts off. The thermostat will then cycle the compressor on and off to maintain this selected temperature. Adjust the fan speed for desired air circulation.

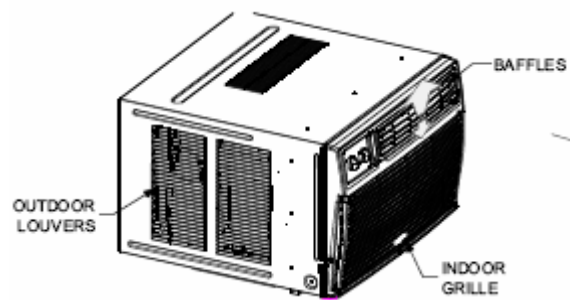

### Changing airflow Direction Baffles

Airflow on unit may be diverted left or right from center by baffles. Upward and downward air discharge is provided by tilting louvers for desired airflow pattern.

### Airflow Around Unit

Check the indoor grill and outdoor louvers for obstructions to airflow. Do not block the airflow to and from the unit. If air is obstructed and/or deflected back into the unit, the air conditioner's compressor may cycle off and on rapidly. This could damage your unit.

### Drain Cup Installation and Use

Your air conditioner uses a system where the water removed from the indoor air (condensate) is channeled to the outdoor side of the unit. The outdoor fan blade has a "slinger" ring attached to it that dips into the water and slings the water onto the outdoor coil surface. This is the sound of water you hear during normal operation. The water quickly evaporates on this warm surface and improves the efficiency of your air conditioner. In normal conditions, the unit can evaporate the water as fast as it is removed from the indoor air.

## AIR CONDITIONER USE

Operating your air-conditioner properly helps you obtain the best possible results.

This section explains proper air conditioner operation

### IMPORTANT:

If you turn the air conditioner off, wait at least 3 minutes before turning it back on. This prevents the air conditioner from blowing a fuse or tripping a circuit breaker.

Do not try to operate your air conditioner in the cooling mode when outside temperature is below 65° F (18°C). The inside evaporator coil will freeze up, and the air conditioner will not operate properly.

NOTE: in the event of a power failure, your air conditioner will operate at the previous settings when power is restored.

## Starting Your Air Conditioner-Digital Control

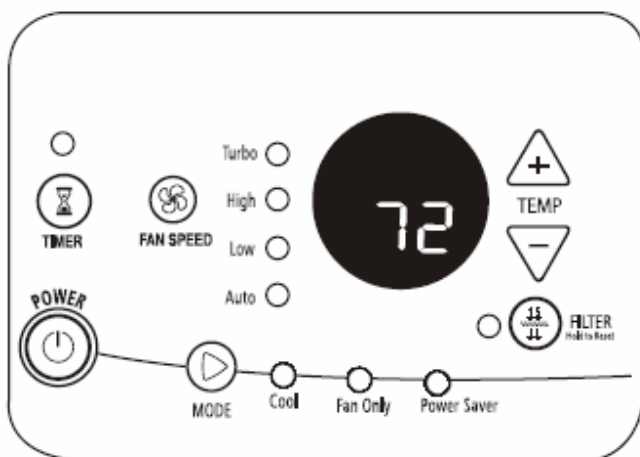

Model WAC12115RB

### NOTES:

When the air conditioner is off, the display shows the current room temperature.

If the room temperature is below 55°F (13°C), the display will show 55°F (13°C). If the room temperature is above 99°F (37°C), the display will show 99°F (37°C).

1. Remove the clear protective film from the control panel and front panel badge (on some models.)
2. Press POWER to turn on the air conditioner.



**Note:** When the air conditioner is turned on for the first time after it is plugged in, it will display the default settings: Cool mode, Turbo fan speed, 72°F (22°C) for 3 seconds. When it is turned on at all other times, it will display the previous settings for 3 seconds, and then display the room temperature.

3. Select mode. See "Mode".
4. Select fan speed. See "Fan Speed"
5. Set temperature. See "Temperature".

### MODE

1. Press MODE until you see the indicator light come on for the setting you desire.

2. Choose Cool, Fan Only or Power Saver.  
Cool – Cools room. You can adjust temperature by pressing the plus or minus button. You can select fan speed by pressing Fan Speed.

Fan Only – Only the fan will run. You can select the fan speed by pressing Fan Speed, but you can not adjust the temperature control setting. The display shows the current room temperature.

Power Saver – The fan runs only when cooling is needed. You can select the fan speed by pressing Fan Speed.

Because the fan does not circulate the room air continuously, less energy is used, but the room air is not circulated as often. Use Power Saver when you are asleep or away from home.



### FAN SPEED

1. Press FAN SPEED until you see the indicator light come on for the setting you desire.

2. Choose Turbo, High, Low, or Auto

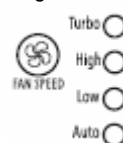

### FILTER MONITOR

1. When the filter indicator light is lit or flashing, remove, clean and replaces the air filter. See "Changing the Air Filter".

2. Press and hold FILTER for 3 seconds after cleaning and replacing the air filter. This resets the filter monitor.

**NOTE:** After 360 hours of fan operating time, the filter indicator light will turn on. It will remain on for 180 hours or until you press FILTER. After 180 hours, it will flash. It will continue flashing until you press FILTER.

---

## TEMPERATURE

---

Press the plus button to raise the temperature. Display shows the temperature control setting. Each time you press or hold the plus button, the temperature will increase 1°F until it reaches 86°F (30°C).

**NOTE:** After 3 seconds, the display will show the current room temperature.



Press the minus button to lower the temperature. The display shows the temperature setting. Each time you press or hold the minus button, the temperature will decrease 1° until it reaches 64°F (18°C).

**NOTE:** After 3 seconds, the display will show the current room temperature.

### To change the temperature display from °F to °C:

1. Turn off the air conditioner.
2. While the air conditioner is off, press and hold down the MODE and FAN SPEED buttons while pressing POWER to turn on the air conditioner.

**NOTE:** Follow these same steps to change the temperature display from °C to °F.

---

## Timer delay

---

### To set the Timer for a 1- to 24-hour delay until the air conditioner turns off (the air conditioner must be On):

1. Press TIMER. Timer indicator light will flash. Display will show remaining hours before air conditioner will turn off.



2. Press the plus or minus button to adjust the delay time (1 to 24 hours).
3. Press TIMER again or wait 10 seconds. Timer indicator light will remain on. Display will show the current room temperature.

### To set the Timer to turn on the air conditioner, keeping previous settings:

1. Turn off air conditioner.
2. Press TIMER. Timer indicator light will flash. Display will show remaining hours before air conditioner will turn on.
3. Press the plus or minus button to change delay time (1 to 24 hours).
4. Press TIMER again or wait 10 seconds. Timer indicator light will remain on. Display will show current room temperature.

### To set the timer to turn on the air conditioner, changing the previous settings:

1. Turn on air conditioner.
2. Adjust Mode to Cool, Fan Only, or Power Saver.
3. Adjust Fan Speed to Turbo, High, Low, or Auto.
4. Adjust temperature between 64°F (18°C) and 86°F (30°C).
5. Wait 3 seconds before turning off air conditioner.
6. Press TIMER. Timer indicator light will flash. Display will show remaining hours before air conditioner will turn on.
7. Press the plus or minus button to change delay time (1 to 24 hours).
8. Press TIMER again or wait 10 seconds. Timer indicator light will remain on. Display will show current room temperature.

### To clear Timer Delay program:

**Note:** Air conditioner can be either off or on.

Press and hold timer for 3 seconds. Timer indicator light will shut off.

### To see or change the remaining time (in hours):

1. Press TIMER once after it has been programmed. Display will show remaining time.
2. While the display is showing the remaining time, you can press the plus or minus button to increase or decrease the time.
3. After 10 seconds, display will show the current room temperature.

---

## To operate air conditioner with remote control

---

**NOTE:** Remote control may vary in appearance.

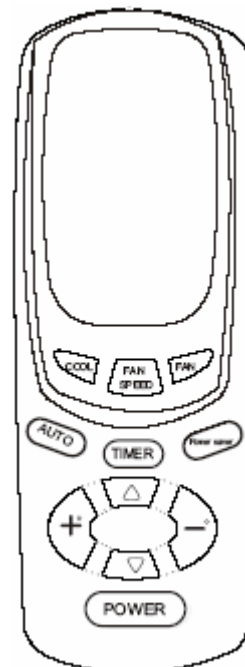

**NOTE:** Two AAA batteries (included) power the remote control. Replace the batteries after 6 months of use, or when the remote control starts to lose power.

**To turn the air conditioner on or off**

Press POWER



**To select the mode:**

Press COOL, FAN, or POWER SAVER



**To select the fan speed:**

Press FAN SPEED or AUTO for Turbo, High or Low.

**NOTE:** Auto fan speed can not be selected in Fan Only mode.



**To raise the temperature:**

Press the plus button to raise the temperature. Each time you press or hold the plus button, the temperature will go up 1°F until it reaches 86°F (30°C).



**To lower the temperature:**

Press the minus button to lower the temperature. Each time you press or hold the minus button, the temperature will go down 1°F until it reaches 64°F (18°C).



**To set Timer for a 1- to 24-hour delay before air conditioner is turned off (air conditioner must be on):**

1. Press TIMER. Indicator light on air conditioner control panel will flash.



2. Press the plus or minus button to change the delay time from 1 to 24 hours.

3. Press TIMER again or wait 10 seconds. Indicator light on air conditioner control panel will remain on.

**To set Timer to turn on air conditioner, keeping previous settings:**

1. Turn off air conditioner.  
2. Press TIMER. Indicator light on air conditioner control panel will flash.

3. Press the plus or minus button to change delay time (1 to 24 hours).

4. Press TIMER again or wait 10 seconds. Indicator light on air conditioner control panel will remain on.

**To set Timer to turn on air conditioner, changing the previous settings:**

1. Turn on air conditioner.  
2. Adjust Mode to Cool, Fan Only, or Power Saver.  
3. Adjust Fan Speed to Turbo, High or low, or Auto.  
4. Adjust temperature between 64°F (18°C) and 86°F (30°C).  
5. Turn off Air Conditioner.

6. Press TIMER. Indicator light on air conditioner control panel will flash.

7. Press the plus or minus button to change delay time (1 to 24 hours).

8. Press TIMER again or wait 10 seconds. Indicator light on air conditioner control panel will remain on

**Starting your Air Conditioner – Rotary Control**

**Model WAC12115MB**

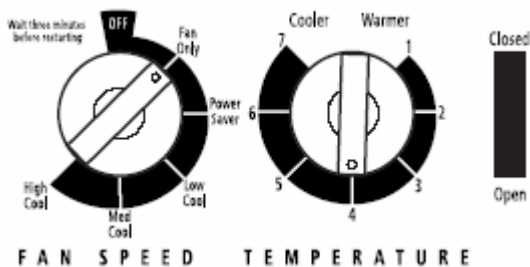

**Model WAC12230MB**

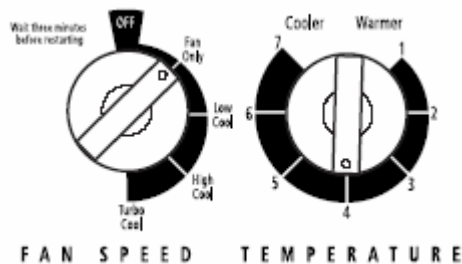

1. Set exhaust control. See "Exhaust Control (on some models)"
2. Select the fan speed. See "Fan Speed".
3. Set Temperature. See "Temperature"

## FAN SPEED

Set FAN SPEED to the desired setting. When the air conditioner is operating at Low Cool, High Cool (on some models), Med Cool (on some models), or Turbo Cool (on some models), the fan circulates air continuously.

Turbo Cool (on some models)	For maximum cooling
High Cool (on some models) cooling (depending on model).	For normal to maximum cooling
Med Cool (on some models)	For normal cooling
Low Cool	For sleeping comfort
Power Saver (on some models) cooling is needed.	Fan will run only when
Fan Only without cooling.	To move air continuously

### Model WAC12115M

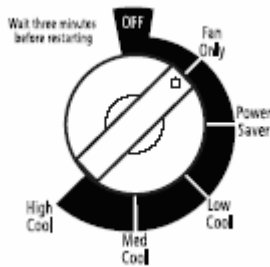

### Model WAC12230M

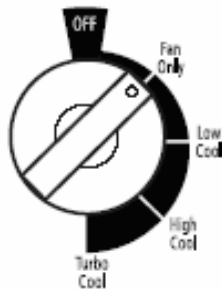

## TEMPERATURE

Turn the TEMPERATURE control to a mid-setting. Adjust the air conditioner's performance by turning the Temperature control clockwise for maximum cooling. For less cooling, turn the TEMPERATURE control counterclockwise. Experiment to find the setting that suits you best.

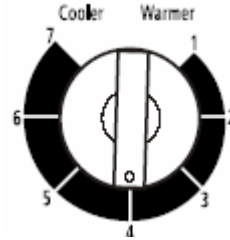

### Changing Air Direction

Roll the wheel to direct the air right or left. Rotate the whole cartridge to direct air up, down, or straight ahead.

### Normal Sounds

When your air conditioner is operating normally, you may hear sounds such as:

Clicking Sound. The water droplets help cool the condenser.

Air movement from the fan.

Clicks from the thermostat cycle

Vibrations or noise due to poor wall or window construction.

A high-pitched hum or pulsating noise caused by the modern high-efficiency compressor cycling on and off.

---

## AIR CONDITIONER CARE

---

Your new air conditioner is designed to give you many years of dependable service. This section tells you how to clean and care for your air conditioner properly. Call your local authorized dealer for an annual checkup. Remember... the cost of this service call is your responsibility.

---

### Cleaning the Air Filter

The air filter is removable for easy cleaning. A clean filter helps remove dust, lint, and other particles from the air and is important for best cooling and operating efficiency. Check the filter every 2 weeks to see whether it needs cleaning.

**NOTE:** Do not operate the air conditioner without the filter in place.

1. Turn off air conditioner.
2. Remove air filter by sliding filter out from either side of unit.
3. Use a vacuum cleaner to clean the air filter. If air filter is very dirty, wash it in warm water with a mild detergent. Do not wash air filter in the dishwasher or use any chemical cleaners. Air dry filter completely before replacing to ensure maximum efficiency.
4. Replace air filter by sliding filter back into either side of unit.

---

### Cleaning the Front Panel

1. Turn off air conditioner
2. Remove the air filter and clean it separately. See Cleaning the Air Filter.
3. Wipe the front panel with a soft, damp cloth.
4. Air dry front panel completely.

---

### Repairing Paint Damage

Check once or twice a year for paint damage. This is very important, especially in areas near oceans or where rust is a problem. If needed, touch up with a good grade enamel paint.

**NOTE:** To reduce paint damage during the winter, install a heavy duty cover over air conditioner cabinet.

---

### Annual Maintenance

Your air conditioner needs annual maintenance to help ensure steady, top performance throughout the year. Call your local authorized dealer to schedule an annual checkup. The expense of an annual inspection is your responsibility.

---

## TROUBLESHOOTING

Before calling for service, try the suggestions below to see whether you can solve your problem without outside help.

---

Air Conditioner will not operate

---

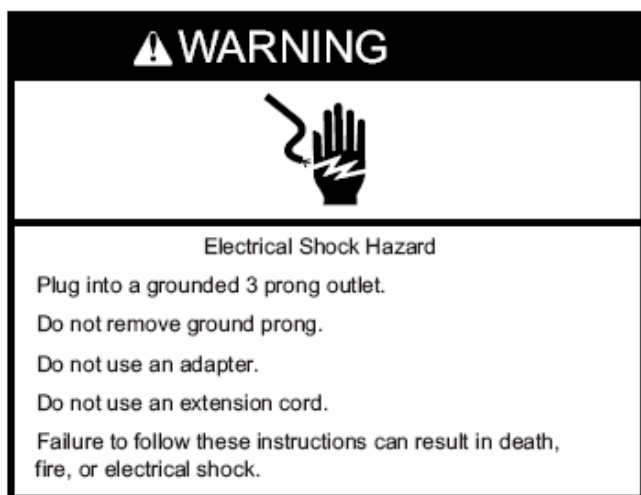

**The power supply cord is unplugged.** Plug into a grounded 3 prong outlet. See "Electrical Requirements".

**The power supply cord has tripped (Reset button has popped out).** Press and release RESET (listen for click; Reset button will latch and remain in) to resume operation.

**A household fuse has blown, or a circuit breaker has tripped.** Replace the fuse or reset the circuit breaker. If the problem continues, call an electrician. See "Electrical Requirements".

**Depending on model, the Power button has not been pressed or the Fan control is turned to Off.** Press POWER or turn the Fan control to an active setting.

**The local power has failed.** Wait for power to be restored.

---

**Air Conditioner blows fuses or trips circuit breakers**

---

**Too many appliances are being used on the same circuit.** Unplug or relocate appliances that share the same circuit.

**Time-delay fuse or circuit breaker of the wrong capacity is being used.** Replace with a time-delay fuse or circuit breaker of the correct capacity. See "Electrical Requirements".

**An extension cord is being used.** Do not use an extension cord with this or any other appliance.

**You are trying to restart the air conditioner too soon after turning the unit off.** Wait at least 3 minutes after turning the unit off before trying to restart the air conditioner.

---

**Air conditioner power supply cord trips (Reset button pops out)**

---

**Disturbances in your electrical current can rip (Reset button will pop out) the power supply cord.** Press and release RESET (listen for click; Reset button will latch and remain in) to resume operation.

**Electrical overloading, overheating, pinched cord can trip (Reset button will pop out) the power supply cord.**

After correcting the problem, press and release RESET (Listen for click; Reset button will latch and remain in) to resume operation.

**NOTE:** A damaged power supply cord must be replaced with a new power supply cord obtained from the product manufacturer and must not be repaired.

---

**Air conditioner seems to run too much**

---

**The current air conditioner replaced an older model.** The use of more efficient components may cause the air conditioner to run longer than an older model, but the total energy consumption will be less. Newer air conditioners do not emit the blast of cold air you may be accustomed to from older units, but this is not an indication of lesser cooling capacity or efficiency. Refer to the efficiency rating (EER) and capacity rating (in BTU/hr.) marked on the air conditioner.

**The air conditioner is in a heavily occupied room, or heat-producing appliances are in use in the room.** Use exhaust vent fans while cooking or bathing and try not to use heat-producing appliances during the hottest part of the day. A higher capacity air conditioner may be required, depending on the size of the room being cooled.

---

**Air conditioner cycles on and off too much, or does not cool/heat room in cooling/heating mode**

---

**The Mode or Fan control is set to Power Saver (on some models).** Use power Saver only when you are asleep or away from home, since the fan does not circulate the room air continuously. Use Low Cool, High Cool or Turbo Cool for your best comfort.

**The air conditioner is not properly sized for your room.** Check the cooling capabilities of your room air conditioner. Room air conditioners are not designed to cool multiple rooms.

**The filter is dirty or obstructed by debris.** Clean the filter.

**The inside evaporator and outside condenser coils are dirty or obstructed by debris.** See Annual Maintenance.

**There is excessive heat or moisture (open container cooking, showers, etc.) in the room.** Use a fan to exhaust heat or moisture from the room. Try not to use heat producing appliances during the hottest part of the day.

**The louvers are blocked.** Install the air conditioner in a location where the louvers are free from curtains, blinds, furniture, etc.

**The outside temperature is below 65°F (18°C).** Do not try to operate your air conditioner in the cooling mode when the outside temperature is below 65°F (18°C).

**The temperature of the room you are trying to cool is extremely hot.** Allow extra time for the air conditioner to cool off a very hot room.

**Windows or doors to the outside are open.** Close all windows and doors.

**The Vent control is set to OPEN (on some models).** Push the Vent control to CLOSED for maximum cooling and/or heating.

**The temperature set point or Thermostat control is not at a cool enough setting.** Adjust the temperature set point to a cooler setting by pressing the minus button to reduce the temperature or adjust the Thermostat control to a cooler setting by turning the knob clockwise. Turn the Fan control to Turbo Cool.

---

**Temperature on display does not match room temperature**

---

**When the compressor and fan motor turn off during Power Saver mode, or after you turn off the unit, a lower temperature reading than the actual room temperature may be displayed for a short period of time.** This lower temperature reading is caused by the temperature sensor being located close to the cold evaporator coil. The actual room temperature will display within a few minutes.

---

**Water drips from cabinet into your house**

---

**The air conditioner is not properly leveled.** The air conditioner should slope slightly downward toward the outside. Level the air conditioner to provide a downward slope to ensure proper drainage. See the Installation Instructions.

**NOTE:** Do not drill a hole into the bottom of the metal base and condensate pan.

## SPECIFICATIONS

	<b>WAC12230MB</b>	<b>WAC12115RB</b>	<b>WAC12115MB</b>
<b>BTU COOLING</b>	12000	12000	12000
<b>BTU HEATING</b>	na	na	na
<b>EER</b>	9.8	9.8	9.8
<b>DEHUMIDIFICATION (pints/hr)</b>	3.52	3.52	3.52
<b>AIRFLOW CFM MAX</b>	310	310	310
<b>VOLTAGE</b>	208/230 VAC	115 VAC	115 VAC
<b>FREQUENCY/cycle</b>	60 HZ	60 HZ	60 HZ
<b>AMPS COOLING</b>	6.2	11	11
<b>AMPS HEATING</b>	na	na	na
<b>WATTS COOLING</b>	1225	1225	1225
<b>WATTS HEATING</b>	na	na	na
<b>PLUG TYPE</b>	Type B	Type A	Type A
<b>POWER CORD RATING (amps)</b>	15	15	15
<b>POWER CORD TYPE</b>	LCDI	LCDI	LCDI
<b>POWER CORD LENGTH</b>	4'	4'	4'
<b>MIN. CIRCUIT BREAKER SIZE (A)</b>	15		
<b>MIN. CIRCUIT CAPACITY (A)</b>	14.1		
<b>REFRIGERANT CHARGE ( lbs/oz.) (R22)</b>	1.34/21.5	1.34/21.5	1.34/21.5
<b>SOUND dbA (H/M/L)</b>	58/55/53	58/55/53	58/55/53
<b>4 WAY AIR ADJUSTMENT</b>	Yes	Yes	Yes
<b>2 WAY AIR SWING</b>	Yes	Yes	Yes
<b>AIR DISCHARGE</b>	Top Front	Top Front	Top Front
<b>MOTOR TYPE</b>	Ball Bearing	Ball Bearing	Ball Bearing
<b>MOTOR CAPACITOR</b>	15uf	15uf	15uf
<b>CONTROLS</b>	Mechanical	Remote	Mechanical
<b>OPERATING RANGE</b>	64°F to 86°F	64°F to 86°F	64°F to 86°F
<b>CABINET SIZE (inches)</b>			
<b>Width</b>	22 5/8"	22 5/8"	22 5/8"
<b>Depth</b>	21 1/5"	21 1/5"	21 1/5"
<b>Height</b>	15 5/16"	15 5/16"	15 5/16"
<b>WINDOW OPENING</b>	27"-38"	27"-38"	27"-38"
<b>THRU WALL MAX THICKNESS</b>	8 3/16	8 3/16	8 3/16
<b>WEIGHT GROSS/NET (lbs)</b>	92/110	92/110	92/110
<b>APPROVALS</b>	UL/CUL	UL/CUL	UL/CUL

## Warranty

International Refrigeration Products warrants that the product supplied is free from defects in material and workmanship. This warranty is valid as long as this product is properly handled, installed, operated and serviced in accordance with the Installation and Operating Instructions shipped with this unit, and the warranty card is completed and mailed no later than 30 days after date of purchase. All warranty claims must be made within one (1) year (five (5) years for compressor) from date of purchase (unless national regulations require a longer registration period).

This warranty provides free replacement of defective parts only. Labor and replacement parts as a result of normal wear and tear are not covered under this warranty.

Additional claims are excluded, unless required by national regulations. International Refrigeration Products Inc. is not responsible for incidental, consequential, direct, or indirect damages or expenses relating to the use of, or the inability to use the product for any purpose. Other implied warranties are excluded.

This constitutes International Refrigeration Products warranty obligation and replaces any and all prior warranties for this product.

INTERNATIONAL REFRIGERATION PRODUCTS INC.  
11325 Nations Ford Rd., Charlotte, NC 28134-8393  
(704) 504-8590 Phone (704) 504-3023 Fax

Copyright 2006 IRP Inc.

950-0071