

This Owner's Manual is provided and hosted by [Appliance Factory Parts](http://Appliance Factory Parts).

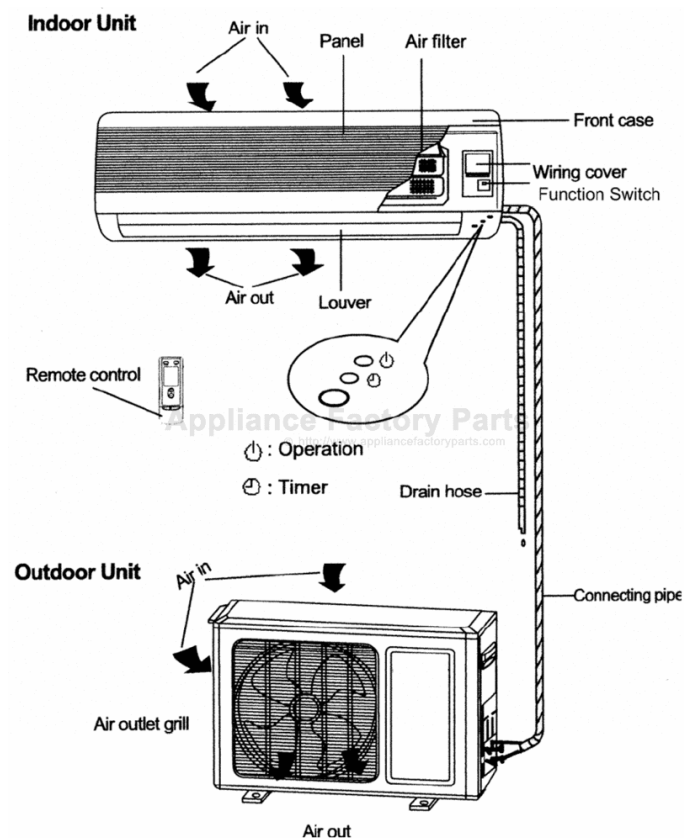

# SEA BREEZE 12A23ZGX Owner's Manual

[Shop genuine replacement parts for SEA BREEZE  
12A23ZGX](#)



[Find Your SEA BREEZE Air Conditioner Parts - Select From 23 Models](#)

----- Manual continues below -----



# **INSTALLATION INSTRUCTIONS**

## **MINI-SPLIT AIR CONDITIONING SYSTEMS**

**FOR MODELS:**

9A23YGX
12A23YGX
12A23ZGX
18A23ZGX

# Table of contents

---

Model Numbers.....	2
Unit Parts and Features.....	3
Installation Dimension Diagram.....	5
Safety Warnings.....	7
Selection of Installation Location.....	8
Indoor Unit Installation.....	9
Outdoor Unit Installation.....	12
Testing.....	14
Warranty.....	17
Specifications.....	18
Troubleshooting Chart.....	19

# Model Numbers

---

## Air Conditioning

SYSTEM MODEL <b>9A23YGX</b>	Indoor Unit	<b>9A23YIGX</b>
	Outdoor Unit	<b>9A23YOGX</b>

**9,000 BTU 115 VAC  
13 SEER**

SYSTEM MODEL <b>12A23YGX</b>	Indoor Unit	<b>12A23YIGX</b>
	Outdoor Unit	<b>12A23YOGX</b>

**12,000 BTU 115 VAC  
13 SEER**

SYSTEM MODEL <b>12A23ZGX</b>	Indoor Unit	<b>12A23ZIGX</b>
	Outdoor Unit	<b>12A23ZOGX</b>

**12,000 BTU 208-230 VAC  
13 SEER**

SYSTEM MODEL <b>18A23ZGX</b>	Indoor Unit	<b>18A23ZIGX</b>
	Outdoor Unit	<b>18A23ZOGX</b>

**18,000 BTU 208-230 VAC  
13 SEER**

# Unit Parts & Features

(Models 9A23YGX, 12A23YGX, 12A23ZGX)

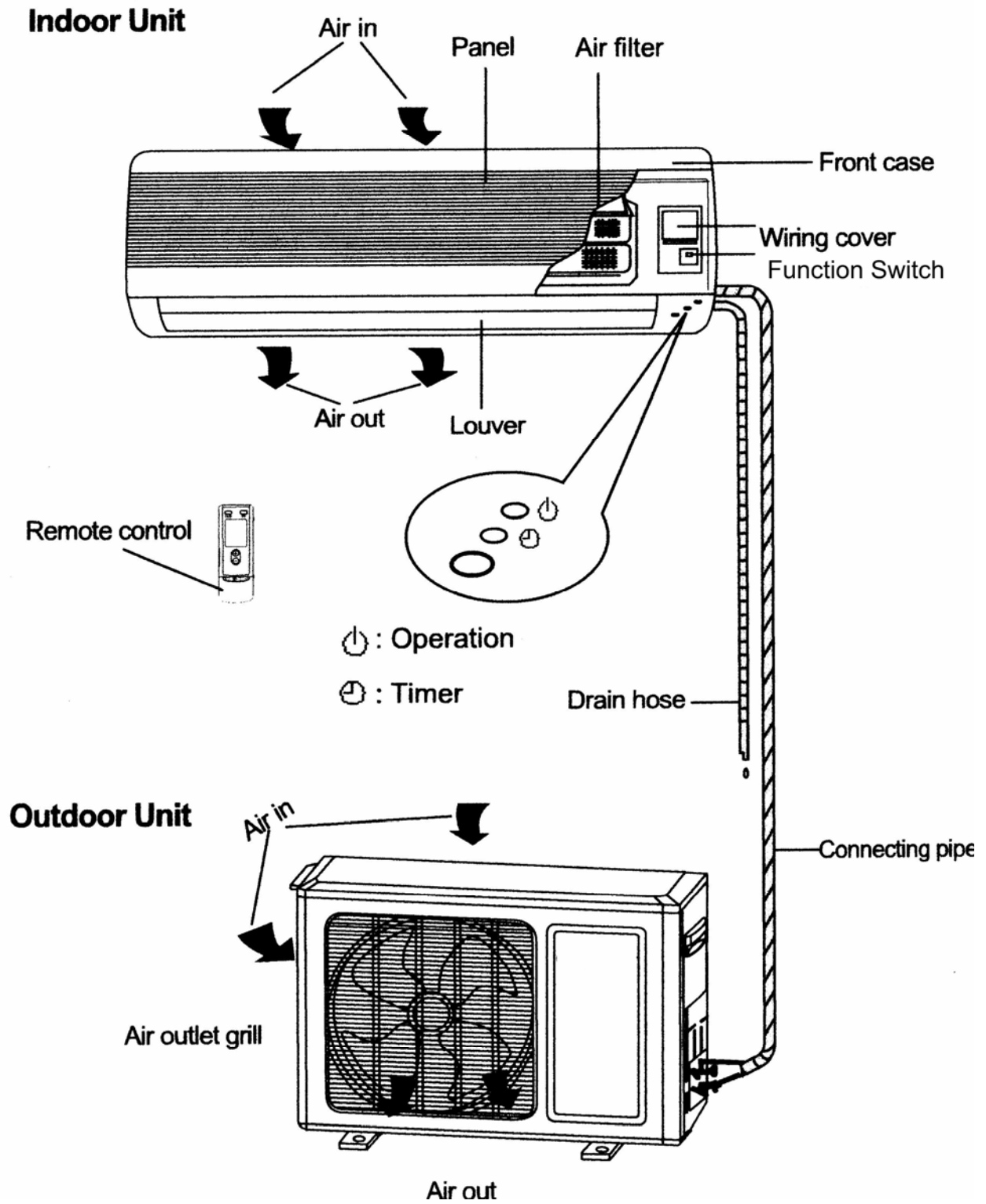

# Unit Parts & Features (Cont)

(Model 18A23ZGX)

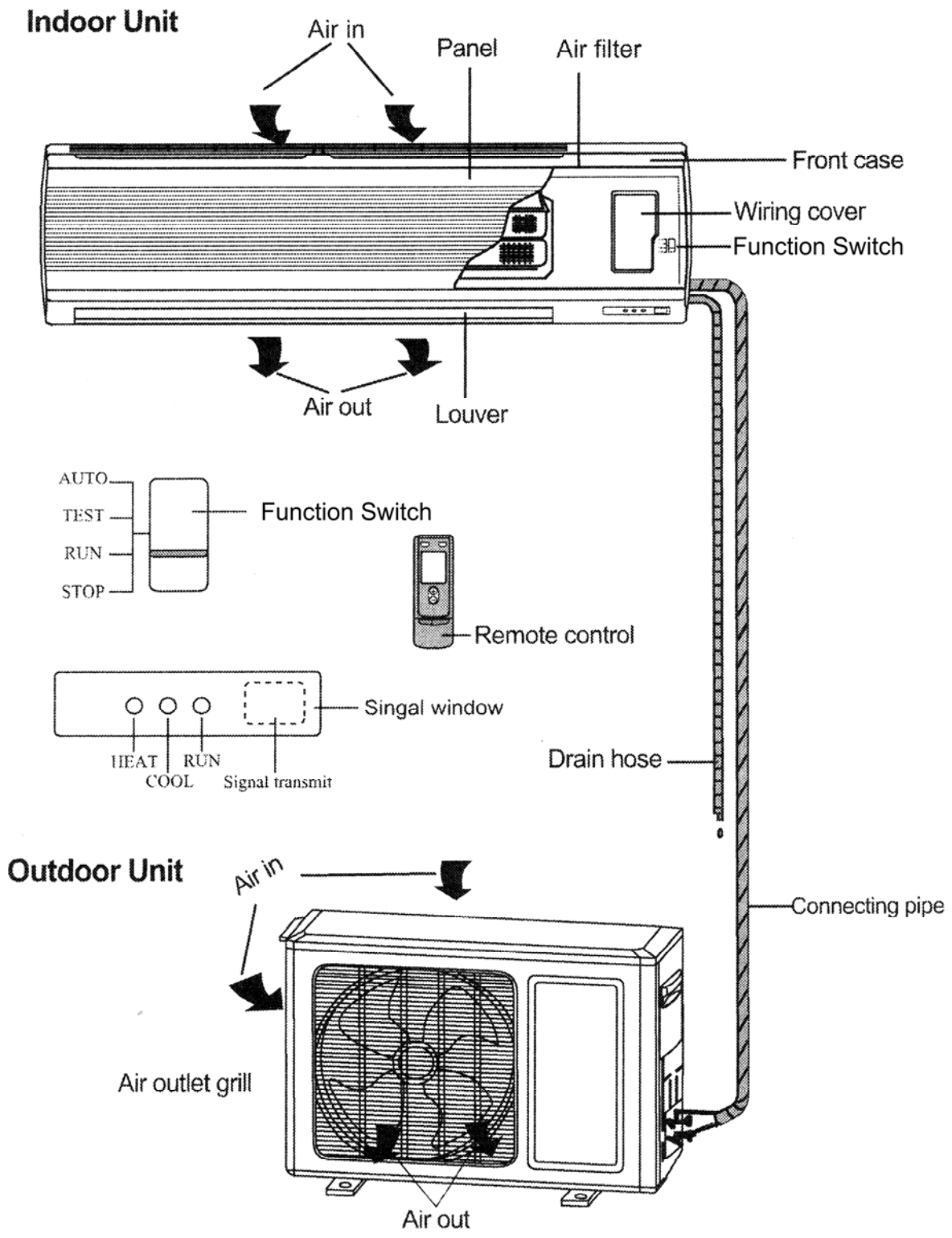

# Installation Dimension Diagram

(Models 9A23YGX, 12A23YGX, 12A23ZGX)

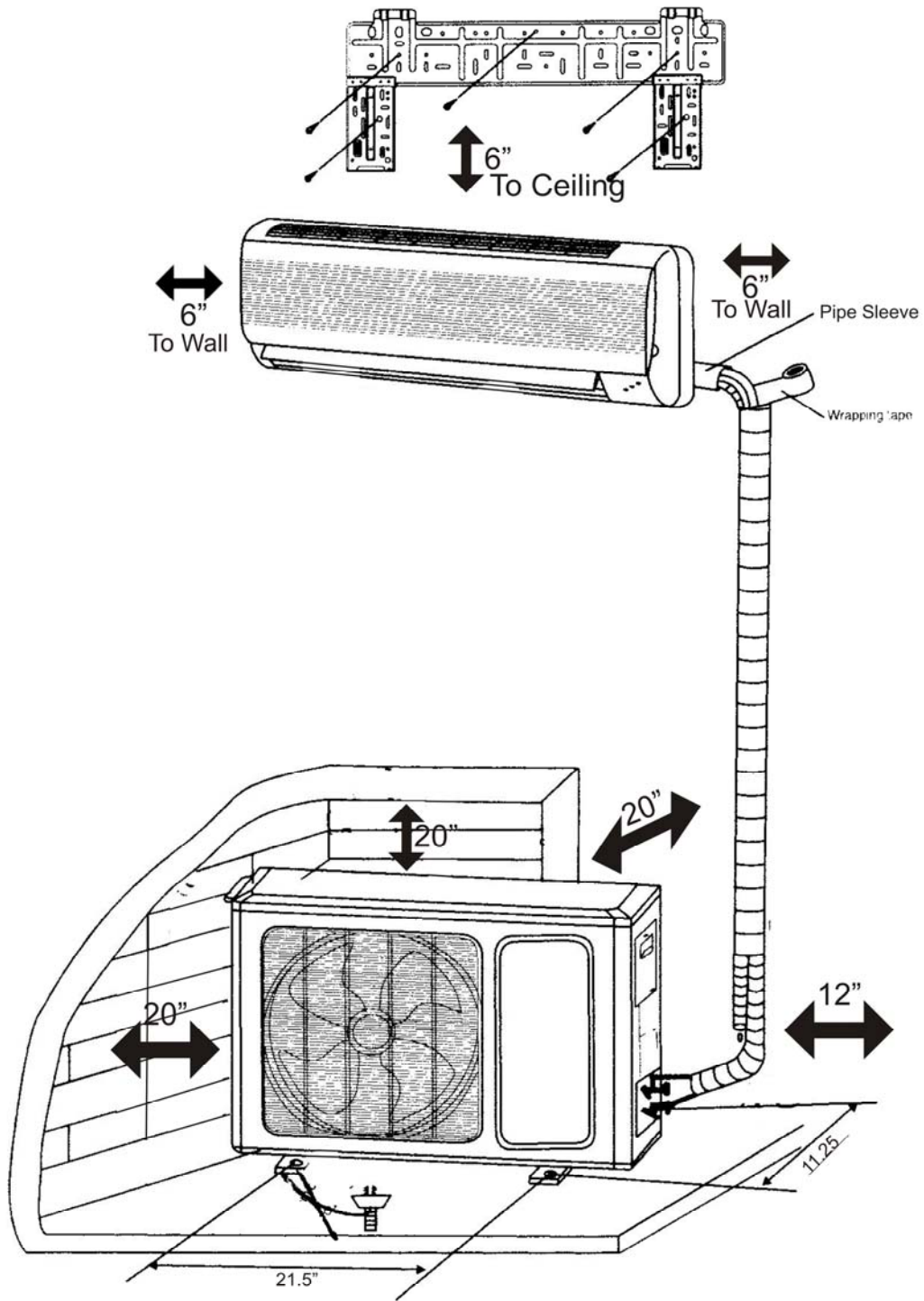

# Installation Dimension Diagram

(Model 18A23ZGX)

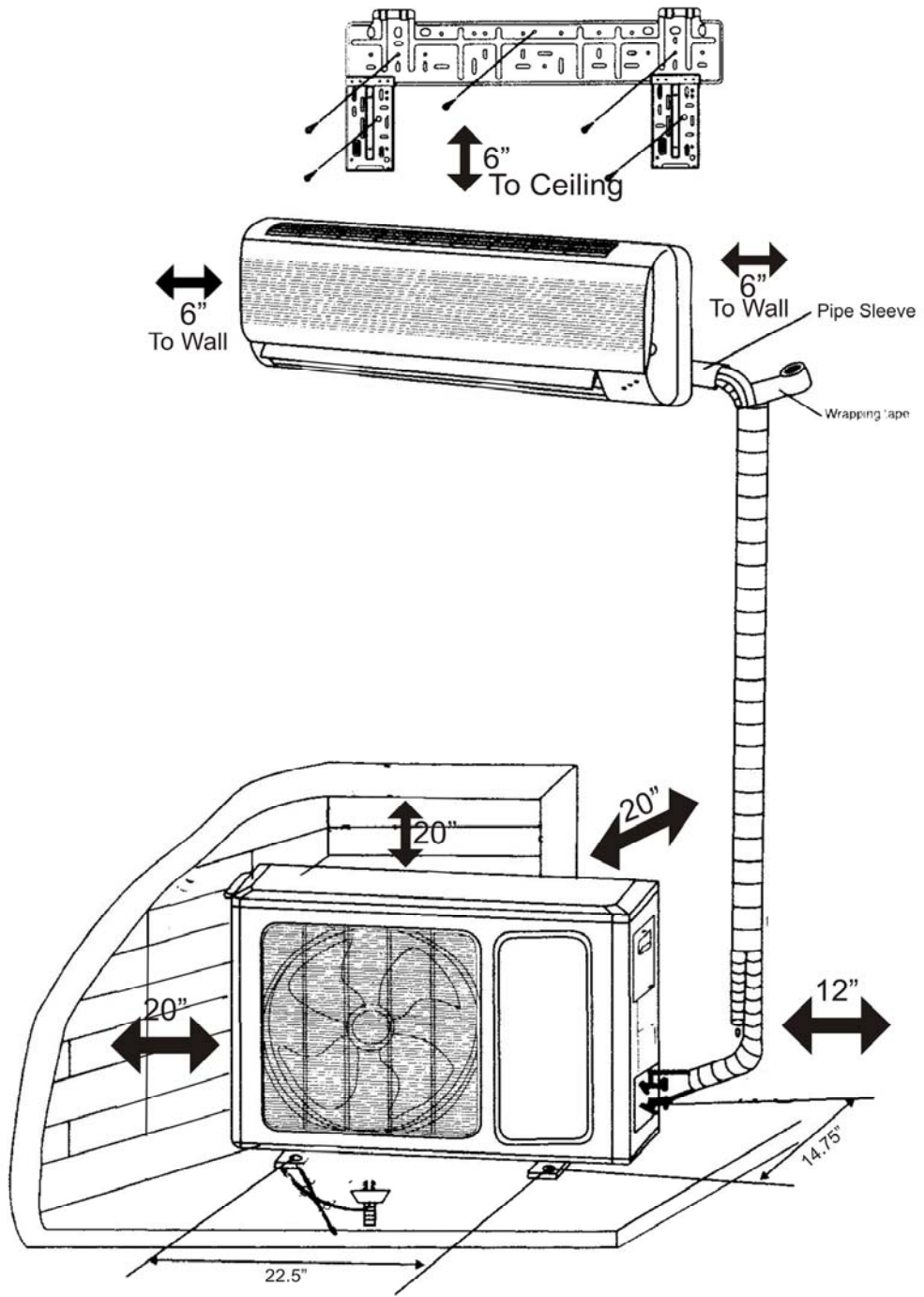

## Safety Warnings

---

- Use Copper Wires only for Power Supply
- Risk of electric shock can cause injury or death. Disconnect all electric power supplies before servicing or installation
- Do not use excessive torque on flare nuts during connection of the refrigeration tubes, or service valve on discharge line may be damaged.
- Do not install indoor unit in damp or wet locations.
- Electrical installation must be done by a qualified technician according to the instruction manual and in accordance with local electrical standards.
- Certified Power supply conductors must be used.

# Selecting of Installation Locations

---

## Indoor Unit:

- Intake and outlet should not be obstructed.
- The wall the unit is to be mounted on should allow for a clear hole for the condensation drain and the refrigeration lines.
- The wall the unit is mounted on should be strong enough to bear the weight and vibration of the unit.
- Allow for proper clearances around the unit - see installation dimension diagram (page 5 and page 6).
- Location should allow easy access for maintenance and removal of air filter.
- Position unit and remote control at least 3 feet from electric appliances such as televisions, radios, etc.
- Keep unit and remote out of direct sunlight and/or florescent lighting and away from any excessive heat source, steam, or flammable materials.

## Outdoor Unit

- Allow sufficient ventilation around the unit - see installation dimension diagram (page 5 and page 6).
- The air intake and outlet should not be obstructed.
- Position unit so that noise and outlet airflow will not inconvenience neighbors.
- Position unit on a solid foundation. Location should be able to withstand the full weight and vibration of the unit.
- Installation should not be performed in the following locations exposed to: machine oil, flammable or corrosive gases, high - frequency waves (i.e. from radio equipment, medical equipment, etc.)

## Both Indoor and Outdoor Units:

Installation of Either unit in the following locations may cause malfunction. Locations exposed to:

- machine oil
- flammable or corrosive gasses
- high frequency waves (i.e. from radio equipment, medical equipment, etc.)

# Indoor Unit Installation

---

## Install the Rear Panel (mounting plate)

Always mount rear panel horizontally.

Hold the rear panel on the wall where you want the unit to be located and ensure that it is level using a plumb line or level. Once leveled, mark the screw locations on the wall.

Fasten the rear panel to the wall at the location marked using the screws supplied with the unit.

Insure that the panel has been mounted firmly to withstand the weight of the unit, with the weight being evenly distributed by each screw.

## Install the Piping Hole

- Select the location for the piping hole - either left-positioned or right-positioned (see installation dimension diagram on page 5 and page 6).
- Make piping hole in the wall approximately 2.5 inches in diameter at a slight downward slant (this ensures proper drainage).
- Insert a piping-hole sleeve in the hole (i.e. PVC pipe) to prevent the connection piping and wiring from being damaged

## Install Drainage Hose Extension (optional)

- Drainage hose extension is included with unit, for use if attached drainage line is not long enough for your application.
- Please note that the extension can be installed after existing drainage pipe is fed through wall later in the installation process, if it is determined later that it is necessary.
- Do not wrench or bend drainage hose or extension.

## Wire the Indoor Unit.

- Note: All electrical wiring must be done by a qualified technician in accordance with local electrical codes.
- A separate circuit breaker must be provided.
- AC power for the indoor unit is provided by the power cable that runs between the outdoor unit and the indoor unit.
- If a disconnect switch is required for the indoor unit, it must be properly rated. (see specifications)

MODEL	INTERCONNECTING WIRE GAUGE	POWER SUPPLY WIRE GAUGE	Min CIRCUIT AMAPCITY	Max CIRCUIT BREAKER	Max FUSE SIZE
9A23YGX	16 AWG	14 AWG	10 AMP	15 AMP	15 AMP
12A23YGX	16 AWG	14 AWG	11.6 AMP	20 AMP	20 AMP
12A23ZGX	16 AWG	14 AWG	5.4 AMP	15 AMP	15 AMP
18A23ZGX	16 AWG	14 AWG	10.5 AMP	20 AMP	20 AMP

# Indoor Unit Installation (Cont)

## Terminal Board Diagram

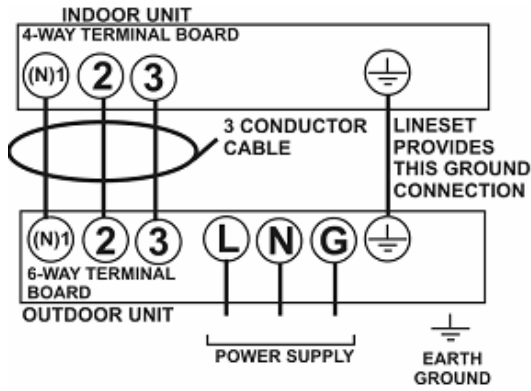

MODEL: 9A23YGX  
12A23YGX

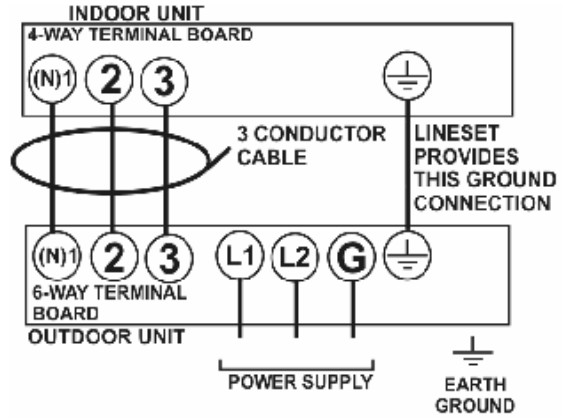

MODEL: 12A23ZGX

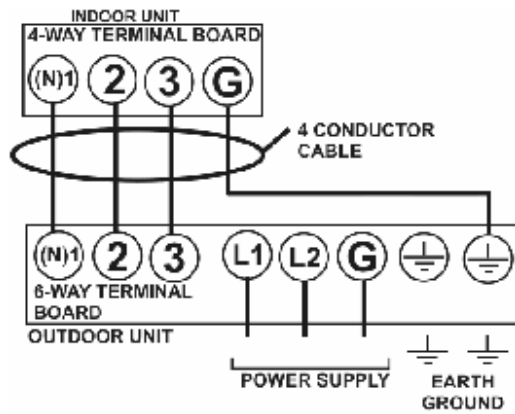

MODEL: 18A23ZGX

**NOTE:**

Power Connection cable is provided in the installation kit (sold separately). If the cable is not of sufficient length, it will be necessary to purchase cable for this purpose.  
Do not splice cable.

# Indoor Unit Installation (Cont)

## Prepare refrigeration Lines

- Refrigeration Lines and wiring can be routed from the indoor unit several different ways using the cut-out access pieces on the back of the unit.
- Bend the refrigeration lines carefully to the position needed to align with the drilled piping hole.

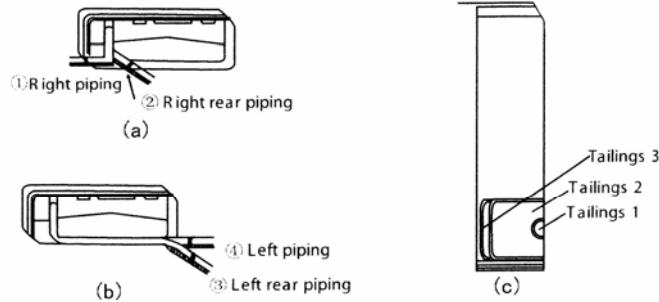

Fig. 4

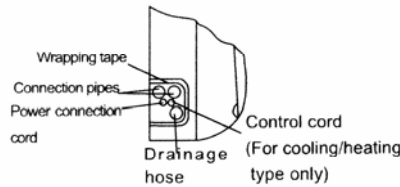

Fig. 5

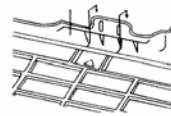
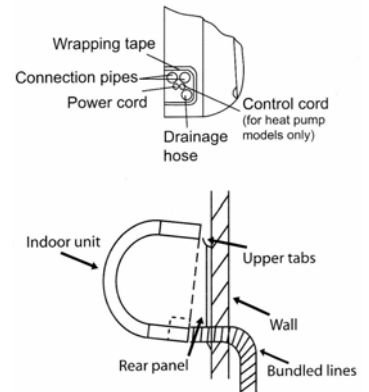

Fig. 6

## Hang Indoor Unit

- Bundle the refrigeration lines, drainage hose, and wiring conduit attached to the indoor unit and wrap them securely for enough length to extend through the piping hole to the exterior of the building. (Note: leave remainder unwrapped to allow for remaining step in installation of the outdoor unit and connecting the indoor unit to the outdoor unit.)
- Carefully push bundled lines through the piping hole.
- Hang the unit on the wall by hooking the mounting slots of the unit over the upper tabs of the rear panel.
- Check to make sure the: unit is properly secured - it should feel firmly attached to the wall, and you should not be able to slide it to the right or left.



# Outdoor unit Installation

---

## Connect Refrigeration Lines to Bundled Lines from Indoor Unit

- Use standard A/C practices to attach the connection pipes to the proper pipes of the bundled lines coming through the wall from the indoor unit.
- Tighten the flare nut of the connection pipes using a spanner and torque wrench. (see diagram)
- Note: Do not over-tighten flare nuts, or the connection may be damaged.

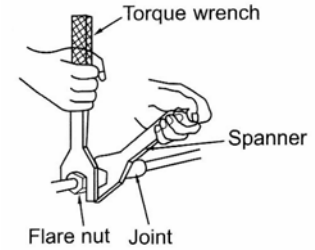

## Insulate/Bundle Refrigeration Lines and Wiring

- Individually insulate all refrigeration lines and condensation drainage hose to ensure that they do not sweat. This will help to maintain the unit at its proper capacities.
- Once all lines have been properly insulated, bundle the refrigeration lines with the wiring conduit and wrap securely to complete the run to the outdoor unit.
- Note: The condensation drainage hose should be left free of the bundled lines in order to drain properly.

## Install Outdoor Condensation Drainage Hose (Heat Pump Models only)

- When the heat pump unit is heating or defrosting, wastewater forms in the outdoor unit. This can be drained off using the outdoor drain elbow and hose provided.
- Insert the drain elbow into the hole on the base plate as shown.
- Join the drain hose to the elbow and turn so that the water drains to the desired location.

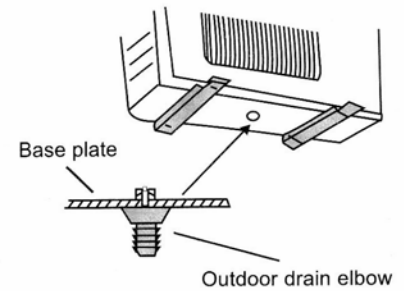

# Outdoor Unit Installation (Cont)

---

## Position Outdoor unit

- Review page 5 for assistance in selecting location for outdoor unit.
- Make sure unit is positioned solidly and level on its foundation. Use leveling feet if necessary.
- If possible affix unit to foundation using proper hardware.

## Connect refrigeration lines to Outdoor Unit

- Remove caps on outdoor unit
- Use standard A/C practices to attach the refrigeration lines bundled in step 2 to the outdoor unit.
- Tighten the flare nut of the connection pipes using a spanner and torque wrench. (see diagram)
- Note: Do not over-tighten flare nuts, or the connection may be damaged.

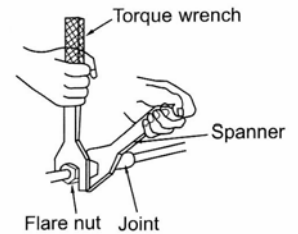

## Wire the outdoor unit

- Refer to page 9 for proper wire sizes
- Refer to page 10 for wiring diagrams.

# Testing

## Notes

- Installation **MUST** be complete prior to testing.
- System **MUST** be tested prior to operation.

## Leakage Test

- Use standard A/C practices to properly check refrigeration tubes and connections for any leaks prior to system start up.

## Air Purging and Pressure Test

- Remove bonnet (cover) of gas valve on outdoor unit.
- Charge system with Nitrogen to 100 PSI and check for leaks. Evacuate Nitrogen.
- Connect the gas valves of a vacuum gauge, vacuum pump, and outdoor unit (see diagram). Start the vacuum pump and allow to run for at least 30 minutes at a level of 500 microns or less.
- Shut off the vacuum and continue to monitor vacuum gauge for another 15 minutes. The pressure should not rise above 800 microns.
- If a vacuum of 500 microns cannot be obtained, or if it rises above 800 microns during the 15-minute monitoring period, pressurize the system with nitrogen and look for leaks. Repair any leaks that are found and repeat the vacuum testing.
- Close the valves to the vacuum pump and gauge and disconnect from the outdoor unit.
- Tighten bonnet (cover) of gas valve and open gas and liquid valves completely.

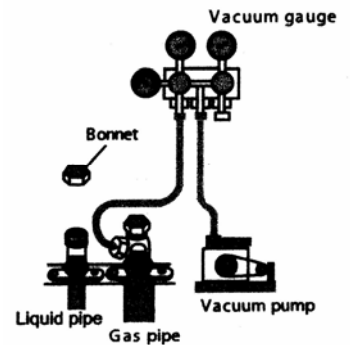

## System Testing

- Before testing the system, ensure that cut-off valves of the connection pipes are opened and that all debris (such as packing scraps, thrums, etc.) are clear from the unit.
- Switch on power to the system and press the "ON/OFF" button on the remote control to activate the indoor unit.
- Press "MODE" button repeatedly, taking a moment on each setting to ensure that system functions in all modes. (Note: HEAT mode will function only on heat pump models)
- If the remote control is lost, emergency run operation can be initiated by pressing the button in the upper right corner of the indoor unit under the cover panel. (see diagram)

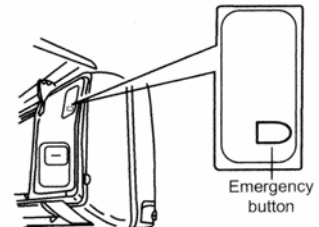

## Installation Verification

- Have both units been securely and firmly installed?
- Are all piping connections secured?
- Have the refrigeration lines been sufficiently insulated?
- Have you verified the length of the connection pipes and the refrigerant capacity?
- Have you conducted all leakage and system tests?
- Does the unit drain properly?
- Are all electrical connections in compliance with local standards?
- Has the unit been properly grounded?
- Is the power cord as specified?
- Are all air inlets and outlets free from obstruction?

# Testing (Cont)

---

## Test operation

Before test operation

- Do not switch on power before installation is complete.
- Verify that all electrical connections are connected properly.
- Verify that valves of the line set have been opened.
- Remove all construction materials such as boxes, packaging, etc from operating area of the units.

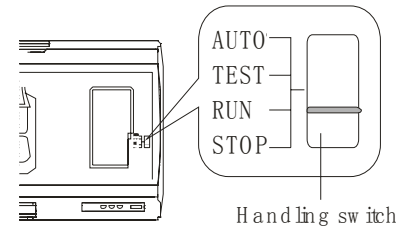

## Manual operation (18,000 BTU) units only

- Turn on power.
- Verify that both units have power, using a DVM check between terminals 1 and 3 on indoor unit for line voltage. If no line voltage is present, STOP. Check connections and wiring between indoor and outdoor unit. Verify that unit has been connected as the proper wiring indicates.
- Press "ON/OFF" button on remote.
- Press "MODE" button to verify operation of all functions. Unit may take up to 4 min. to change modes.

## If remote control is lost:

- Open the front panel.
- Turn function switch to "AUTO" for automatic operation (Factory preset to 81 deg.F.) Unit will operate in all necessary modes to maintain this temperature.
- Turn function switch to "TEST" to operate unit in cool mode. (Unit will operate at last set temperature).
- Turn function switch to "RUN" mode. This mode allows use of remote control for all functions and will be the normal setting for the function switch.
- Turn function switch to "STOP". This function stops all unit functions.

## Testing (Cont)

### IF UNIT FAILS TO OPERATE PROPERLY

ISSUE	CHECK
Unit will not operate	<ul style="list-style-type: none"> <li>✧ Verify that Red "Power" light is illuminated.</li> <li>✧ Verify that line voltage is present between terminals 1 and 3 of indoor unit.</li> <li>✧ Turn unit on with remote. (you should hear a "Beep" from indoor unit). Allow 3-4 min. for unit to restart.</li> <li>✧ Turn unit to "Test" mode. Verify that cooling function works (allow 3-4 min. for unit to restart.)</li> </ul>
Compressor will not operate	<ul style="list-style-type: none"> <li>✧ Turn unit to Cool mode. Allow 3-4 min for compressor timer to operate. Check for line voltage between pins 1 and 2 of indoor unit. If no voltage is present please call technical support.</li> </ul>
The unit vibrates during operation	<ul style="list-style-type: none"> <li>✧ Is the indoor unit firmly attached to the wall?</li> <li>✧ Is the front cover closed properly?</li> </ul>
Inefficient Cooling (heating)	<ul style="list-style-type: none"> <li>✧ Was the refrigerant leakage test performed with good results?</li> <li>✧ Are the air flow grills (inlet and outlet free from obstructions?)</li> <li>✧ Was refrigerant added as necessary?</li> </ul>
Appearance of water or condensation.	<ul style="list-style-type: none"> <li>✧ Were refrigerant lines completely covered with insulation?</li> <li>✧ Is condensate drain routed properly (downward)?</li> </ul>

# WARRANTY

**SEA BREEZE AIR** warrants the accompanying split air conditioner or heat pump system to be free of defects in material and workmanship for the applications specified in the operation manual and installation manual for a period of one (1) year on parts and five (5) years on compressor, valid from the date of original retail purchase in the United States or Canada. Labor is not covered under warranty.

If the unit exhibits a defect in normal use and is determined to be within the warranty period, **SEA BREEZE AIR** will, at its option, either repair or replace the unit free of charge within a reasonable time after the unit is returned.

This warranty **DOES NOT** cover:

- Damage, accidental or otherwise, to the unit while in possession of the consumer that is not a result of a defect in material in workmanship.
- Damage caused by consumer misuse, tampering, or failure to follow all care and maintenance instructions in the manuals.
- Damage to the finish of the case or other parts caused by water.
- Damage caused by repairs or alterations to the unit by anyone other than a qualified technician.
- Filter.
- Freight and Insurance cost for the warranty service.

*Warranty Activation Card must be completed and sent in to activate the warranty for the accompanying unit.*

MINI-SPLIT SPECIFICATIONS					
Model	9A23YGX	12A23YGX	12A23ZGX	18A23ZGX	
Function	COOLING	COOLING	COOLING	COOLING	
Rated Voltage	115V	115V	208-230V	208V-230 V	
Rated Frequency	60HZ	60HZ	60HZ	60HZ	
Total Capacity (BTU/Hr)	9000	12000	12000	18000	
SEER	13	13	13	13	
Power Input (W)	800	960	960	1610	
Rated Input (W)	900	1100	1100	2200	
Rated Current (A)	7.82	9.56	5	11.4	
Air Flow Volume (CFM)	350	388	483	706	
Circuit Breaker Size (A)	15	20	15	20	
Minimum Circuit Ampacity (A)	10	11.6	5.4	10.5	
Dehumidifying Volume (p/h)	4.2	4.2	4.2	6.3	
Indoor unit	Model of Indoor Unit	9A23YIGX	12A23YIGX	12A23ZIGX	18A23ZIGX
	Fan Motor Speed (r/min) (L/M/H)	1100/1200/1300	1100/1200/1300	1350/1450/1550	1200/1300/1400
	Output of Fan Motor (w)	20	20	20	25
	Input of Heater (w)	N/A	N/A	N/A	N/A
	Fan Motor Capacitor (uF)	4	4	1	3.5
	Fan Motor RLA(A)	0.17	0.17	0.09	0.4
	Fan Type-Piece	Cross flow fan -1	Cross flow fan - 1	Cross flow fan - 1	Cross flow fan - 1
	Diameter-Length (in)	3.5X28.5	3.5X28.5	3.5X28.5	4.2X35
	Evaporator	Aluminum fin-copper tube	Aluminum fin-copper tube	Aluminum fin-copper tube	Aluminum fin-copper tube
	Pipe Diameter (in)	0.275	0.275	0.275	0.275
	Row-Fin Gap(in)	3-.062/2-.060	3-.062/2-.060	3-.062/2-.060	2-.055
	Coil length (l) x height (H) x coil width (L)(in)	28.7X15.75X1.57	28.7X15.75X1.57	28.7X15.75X1.57	35.5X15X1
	Swing Motor Model	MP24EA	MP24EA	MP24EA	MP24GA
	Output of Swing Motor (w)	1.5	1.5	1.5	2
	Fuse (A)	3.15A	3.15A	3.15A	3.15A
	Sound Pressure Level dB (A)	38/41/45	39/42/46	40/43/47	48/50/52
Dimension (W/D/H)(in)	35.7X11.4X7.67	35.7X11.4X7.67	35.7X11.4X7.67	46.37X12.8X8.9	
Dimension of Package (W/D/H)(in)	42X15X13	42X15X13	42X15X13	50X16X13	
Net Weight /Gross Weight (LB)	26.5/33	26.5/33	26.5/33	38.5/53	
Outdoor unit	Model of Outdoor Unit	9A23YOGX	12A23YOGX	12A23ZOGX	18A23ZOGX
	Compressor Model	Panasonic 2P14S126B1Y	Panasonic 2P16S126B1P	Panasonic 2P15S236A1H	Hitachi SL253SN-C7EU
	Compressor Type	Rotary	Rotary	Rotary	Hermetic motor compressor
	L.R.A. (A)	49	54	26	39
	Compressor RLA(A)	7.5	8.8	4.1	7.6
	Compressor Power Input(w)	855	750	930	1685
	Overload Protector	Build in	Build in	Build in	Internal Inherent Protector
	Throttling Method	Capillary	Capillary	Capillary	Capillary
	Compressor Start Capacitor (uF)	40	45	30	50
	Starting Method	Capacitor	Capacitor	Capacitor	Capacitor
	Working Temp Range (degF)	23-109	23-109	23-109	23-109
	Condenser	Aluminum fin-copper tube	Aluminum fin-copper tube	Aluminum fin-copper tube	Aluminum fin-copper tube
	Pipe Diameter (in)	0.375	0.375	0.375	0.375
	Rows-Fin Gap(in)	2-.062	2-.062	2-.062	2-.055
	Coil length (l) x height (H) x coil width (L)(in)	30.75X20X1.73	30.75X20X1.73	30.75X20X1.73	26.88X32X1.73
	Fan Motor Speed (rpm)	885	885	920	780
	Output of Fan Motor (w)	48	48	48	60
	Fan Motor RLA(A)	0.42	0.42	0.22	0.56
	Fan Motor Capacitor (uF)	10	10	2	3.5
	Air Flow Volume of Outdoor Unit(CFM)	1265	1265	1265	2649
	Fan Type-Piece	Axial fan -1	Axial fan -1	Axial fan -1	Axial fan -1
	Fan Diameter (in)	15.75	15.75	15.75	18.11
	Defrosting Method	Auto defrost	Auto defrost	Auto defrost	Auto defrost
	Climate Type	T1	T1	T1	T1
	Isolation	I	I	I	I
	Moisture Protection	IP24	IP24	IP24	IP24
	Design Pressure High (PSI)	362	362	362	362
	Design Pressure Low (PSI)	145	145	145	145
	Sound Pressure Level dB (A)	55	55	55	58
	Sound Power Level dB (A)	65	65	65	68
Dimension (W/D/H)(in)	33.4X12.6X21.3	33.4X12.6X21.3	33.4X12.6X21.3	39.6X13.4X33.4	
Dimension of Package (W/D/H)(in)	35X14X23	35X14X23	35X14X23	43X18X36	
Net Weight /Gross Weight (LB)	88/99	88/99	88/99	139/150	
Refrigerant Charge (LB)	R22/2.2	R22/2.75	R22/2.75	R22 / 3.63	
Design Length (ft)	26.25	26.25	26.25	24.6	
Connection Pipe	Extra Refrigerant Charge per feet above	.32 oz/ft	.32 oz/ft	.32 oz/ft	.43 oz/ft
	Outer Diameter Liquid Pipe (in)	1/4	1/4	1/4	3/8
	Outer Diameter Gas Pipe (in)	1/2	1/2	1/2	5/8
	Max Distance Height (ft)	16	16	16	32
	Max Distance Length (ft)	32	32	32	49
	Installation Kit Catalog Number	LS1412GSB	LS1412GSB	LS1412GSB	LS3858GSB

## Mini-Split Error Codes

ERROR CODE	EXPLANATION	RED	YELLOW	GREEN	NOTES
E1	High Pressure protect	1			
E2	Inside Anti-Freeze Protect	2			
E3	Low Pressure Protect	3			
E4	Compressor Discharge protect	4			6 sec Pause before Flash Sequence
E5	low pressure over current protect	5			
E6	indoor-outdoor communication Error	6			
E7	Mode conflict	7			
E8	high Temp protect	8			
E9	cold wind protect	9			
E0	AC Voltage Low	10			
H6	No Indoor motor feedback	11			
F1	room temp sensor open/short		1		
F2	Indoor evaporator sensor open/short		2		
F3	Outdoor temp sensor open/short		3		
F4	Outdoor evaporator sensor open/short		4		6 sec Pause before Flash Sequence
F5	Outdoor sensor open/short		5		
F6	Cooling Overload		6		
F7	Unused		7		
F8	Current Overload		8		
F9	Unused		9		
F0	Unused		10		
H1	Defrost			1	
H2	Static duct clean protect			2	
H3	compressor overload protect			3	
H4	System Abnormal			4	6 sec Pause before Flash Sequence
H5	Mode Protect			5	
H6	Unused			6	
H7	Synchronize fail			7	
H8	Water full protect			8	
H9	PTC heating Error			9	
H0	Heat high temp protect			10	
FA	Pipe Hot				
FH	Freeze Protect				

Notes: Some Codes may not be available on some units.

Codes will flash prior to any change of state I.E. cool off, cool on, heat off, heat on, power on, etc.

Normal operation for indicator lights is as follows: Constant Red: power on, Constant Yellow: heat on, Constant Green: cool on.

Heat Mode available for heat pump units only.