

This Owner's Manual is provided and hosted by Appliance Factory Parts.

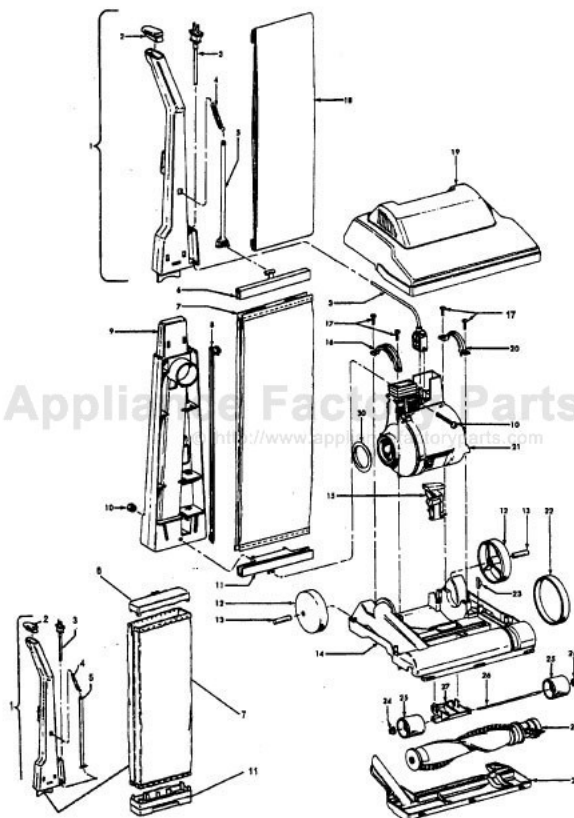

HOOVER U4245-030 Owner's Manual

[Shop genuine replacement parts for HOOVER
U4245-030](#)



[Find Your HOOVER Vacuum Cleaner Parts - Select From 1456 Models](#)

----- Manual continues below part list -----

Available Replacement Parts for HOOVER U4245-030

H-38528040	BELT VACUUM HOOVER OEM (1 PACK)
48414036	HOOVER ELITE BRUSH ROLLER
H-4010001A	VACUUM BAG OEM HOOVER 3 PACK
H-43267002	AGITATOR BEARING ASM
H-43414073	Floor brush.
H-43414064	DUSTING BRUSH (ONE PEICE)
HR-5000	EXTENSION TUBE

Elite

Models U4245, U4245-030, U4245-930,
U4283-970, U4455, U4467, U4467-960,
U4467-970, U4467-980
Model U4247-030, U4249-030, U4250

Sprint

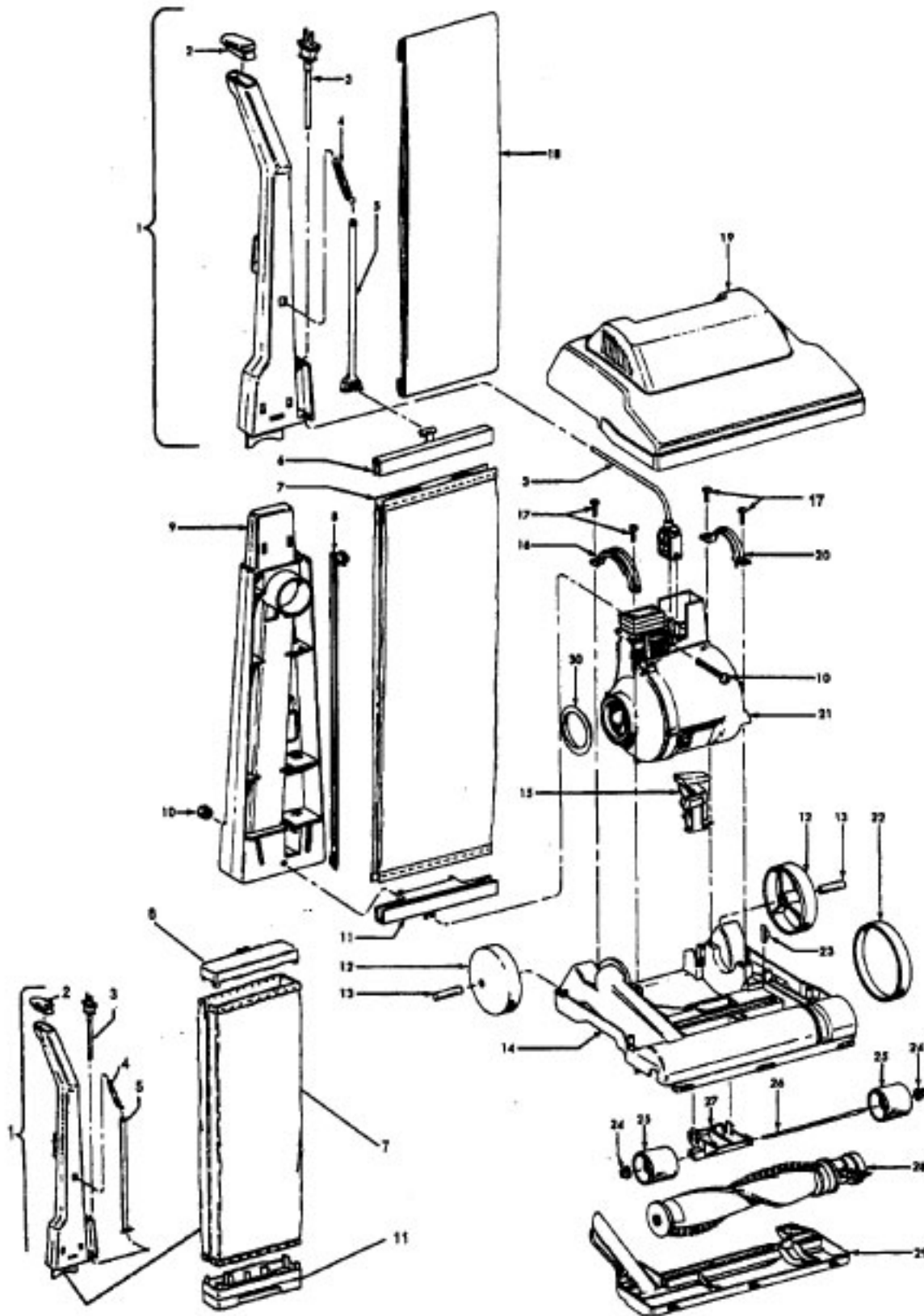

Used on model U4250

Elite

Sprint

Ref. No.	Part No.	Description
1	48663142	Upper Handle Assem. -MW
	48663141	Upper Handle Assem.-ABE-U4250
2	37911079	Handle Cap - ABE
3	46388027	Attachment Cord - AG - 35 Ft.
	46388043	Attach. Cord - AG - 30 Ft. 12 Amp
4	38335020	Bag Strap Spring - AY
5	36425071	Bag Strap - ABE
	36425072	Bag Strap - ABE - U4250
6	36425067	Jacket Support - Upper - MW
	36425064	Jacket Support -Upper-ABE-U4250
7	43674191	Jacket Assem. - Common
	43675183	Jacket Assem. - ABN U4247-030
	43675186	Jacket Assem. - AAY - U4249-030
	43686240	Outer Jacket - AAY - U4250
8	38456036	Switch Control Rod - ABB
9	39464005	Lower Handle - ABE U4247-030
10	40201085	Nut & Bolt Assem.
11	36425068	Jacket Support - Lower - MW
	36425063	Jacket Support-Lower-ABE-U4250
12	38522011	Wheel Rear - AG (2)
13	31523012	Wheel Shaft (2)
14	42242270	Main Body Assem. - AG (Includes Items 12, 13, 23)
15	38458022	Handle Release Lever - AG
16	36131057	Motor Retainer Cap - RH - MW
17	21447217	Screw-Self Tapping (4)
18	4010001A	Throw-Away Bag - (3 Pk.)
19	37252065	Hood Assem. - MT
	37252067	Hood - JM - U4467
	37252087	Hood - MN - U4467-960
	37252081	Hood - MR - U4467-980
	37252110	Hood - AAP - U4283-970
	37252111	Hood - ABN - U4245
	37252112	Hood - ABN - U4245-030, U4245-930
	37252114	Hood - AAY - U4249-030
	37252113	Hood Assem. - ACC U4247-030
	37252115	Hood - AAY - U4250
20	36131090	Motor Retainer Cap - LH - AG
21	43576141	Motor Assem. - (P - 201)
	43576205	Motor Assembly - (P364)
22	38528027	Belt
	38528040	Belt - 12 Amp - U4250
23	13261AY	Rug Nozzle Rib Shoe
24	36131056	Wheel Retainer - BZ (2)
25	36432029	Wheel - AG (Use 43248055)
26	32563012	Wheel Shaft - AY (Use 43248055)
27	N/A	Wheel Support - ABE
	43248055	Front Wheel Assem. (Incl. It. 25, 26)

**Models U4245, U4245-030, U4245-930,
U4283-970, U4455, U4467, U4467-960,
U4467-970, U4467-980**

Model U4247-030, U4249-030, U4250

Ref. No.	Part No.	Description
28	48414079	Agitator Assem. Comp. -AG (P-203)
29	37245108	Bottom Plate - AG
	37245017	Bottom Plate - AG - U4250
30	38784016	Seal

PACKAGING MATERIAL

56511A18	Owner Manual - U4247-030
56511387	Owner Manual - U4245-030, U4245-930
56511390	Owner Manual - U4245
56511343	Owner Manual
56511280	Owner Manual
58185184	Carton - Common
58346004	Front Support
58353009	Rear Support
58369061	Rear Support - U4467-980
58347007	Cleaning Tool Carton - U4245-930, U4467-970
56511B24	Owner Manual - U4250

ITEMS NOT ILLUSTRATED - U4245-930, U4467-970

3944201P	Cord Wrap
38634078	Extension Tube - AG
38617024	Crevice Tool - AG
38614029	Furniture Nozzle - AG
38656016	Converter Body - AAP
43414145	Dusting Brush - AG
43434225	Hose Comp.
34123056	Gasket - 12 Amp Models (located between main body and motor, LH side)

For illustration see Cleaning Tools - Friction Fit - (P - 205)

**Model U4467-980 is packed with a Model S1071-810
Help-Mate Cleaner. (Ref. pages 42/43)**

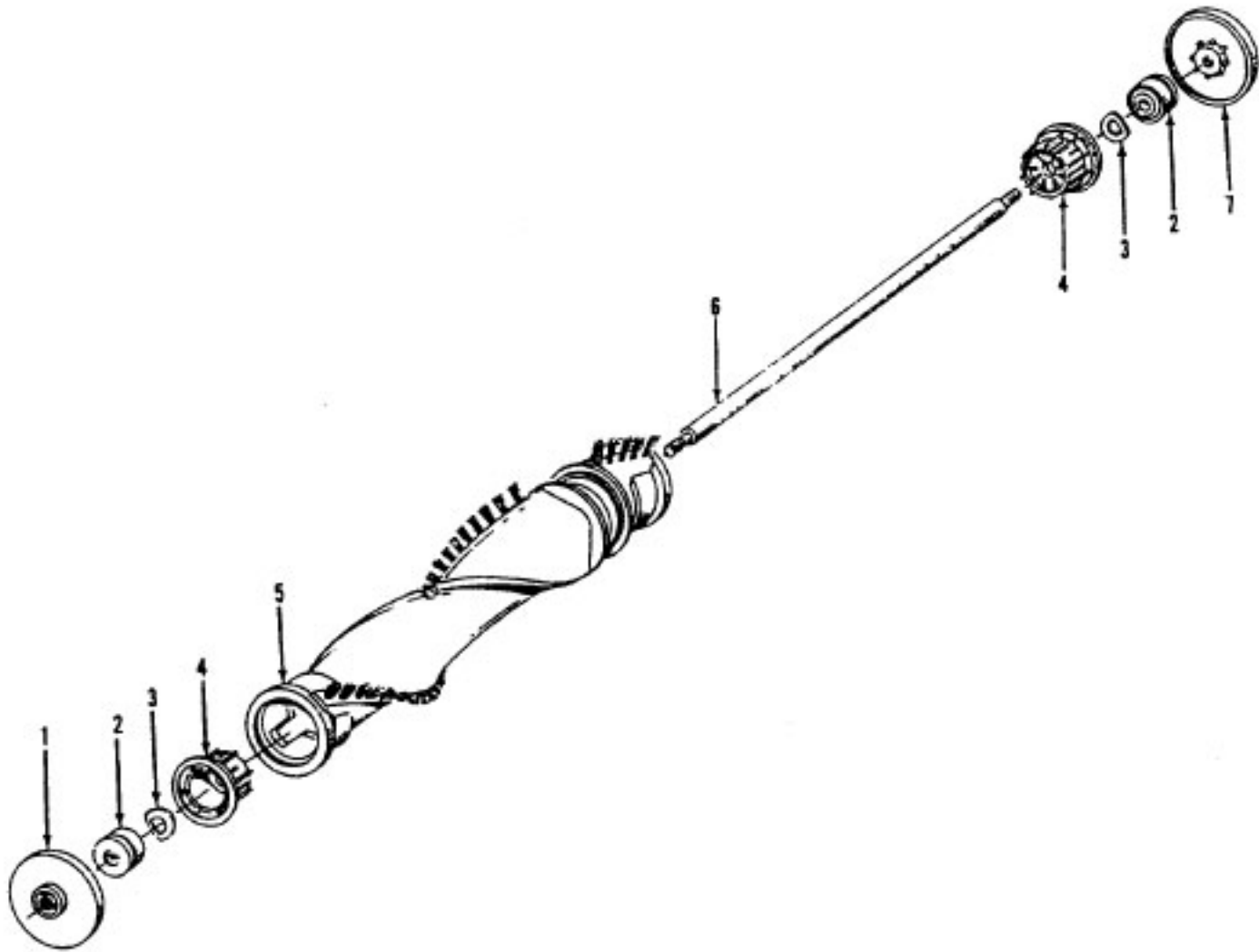

Ref. No.	Part No.	Description
	48414079	Agitator Assem. Comp. - AG
1	36423016	Thread Guard - RH
2	43267002	Agitator Bearing Assem. (2)
3	21347003	Conical Washer (2)
4	36422022	Agitator End (2)
5	N/A	Agitator Body
6	32724013	Agitator Shaft
7	36423017	Thread Guard - LH - AG

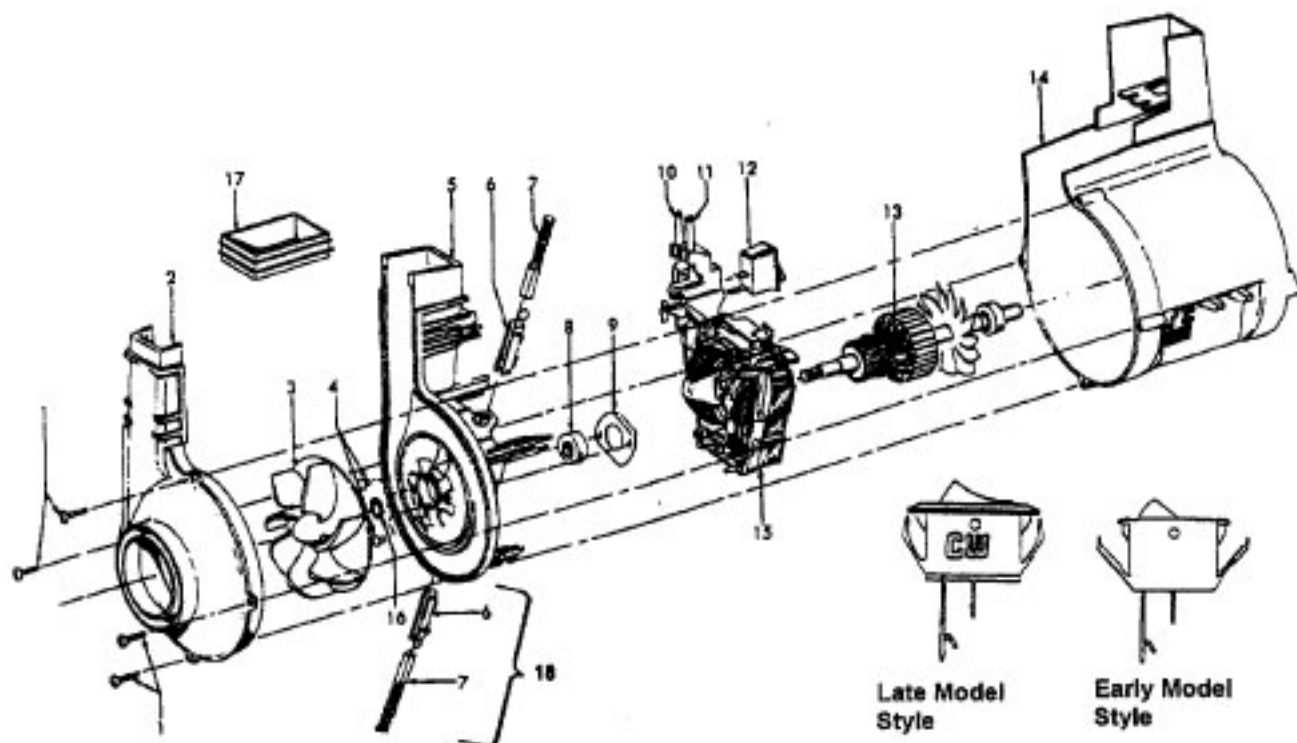

Ref. No.	Part No.	Description
	43576141	Motor Assem. Comp.
1	N/A	Screw-Self Tapping (4)
2	38736033	Fan Chamber
3	38755030	Fan
4	N/A	Rivet-Semi Tubular (2)
5	N/A	Motor Housing Assem.
6	N/A	Motor Brush Holder (2)
7	N/A	Motor Brush Assem. (2)
8	N/A	Bearing
9	N/A	Bearing Retainer
10	36914004	Switch Bus Bar
11	39116005	Attachment Terminal
12	28218043	Switch Assem. - Early Models (Prior to 5/96)
	28161062	Switch Assem. - Late Models (After 5/96)
13	N/A	Armature/Bearing Assem.
14	37194046	Motor End Cap Assem.
15	N/A	Field Assem.
16	21312793	Washer
17	38783020	Duct Seal
18	41311016	Motor Brush Holder Assem. -

ITEMS NOT ILLUSTRATED

38781013	Duct Seal (8 1/2" Long adhesive backed foam seal used on early models in place of item 17)
54821001	Tape (Roll)

Cleaning Tools - Elite Cleaners

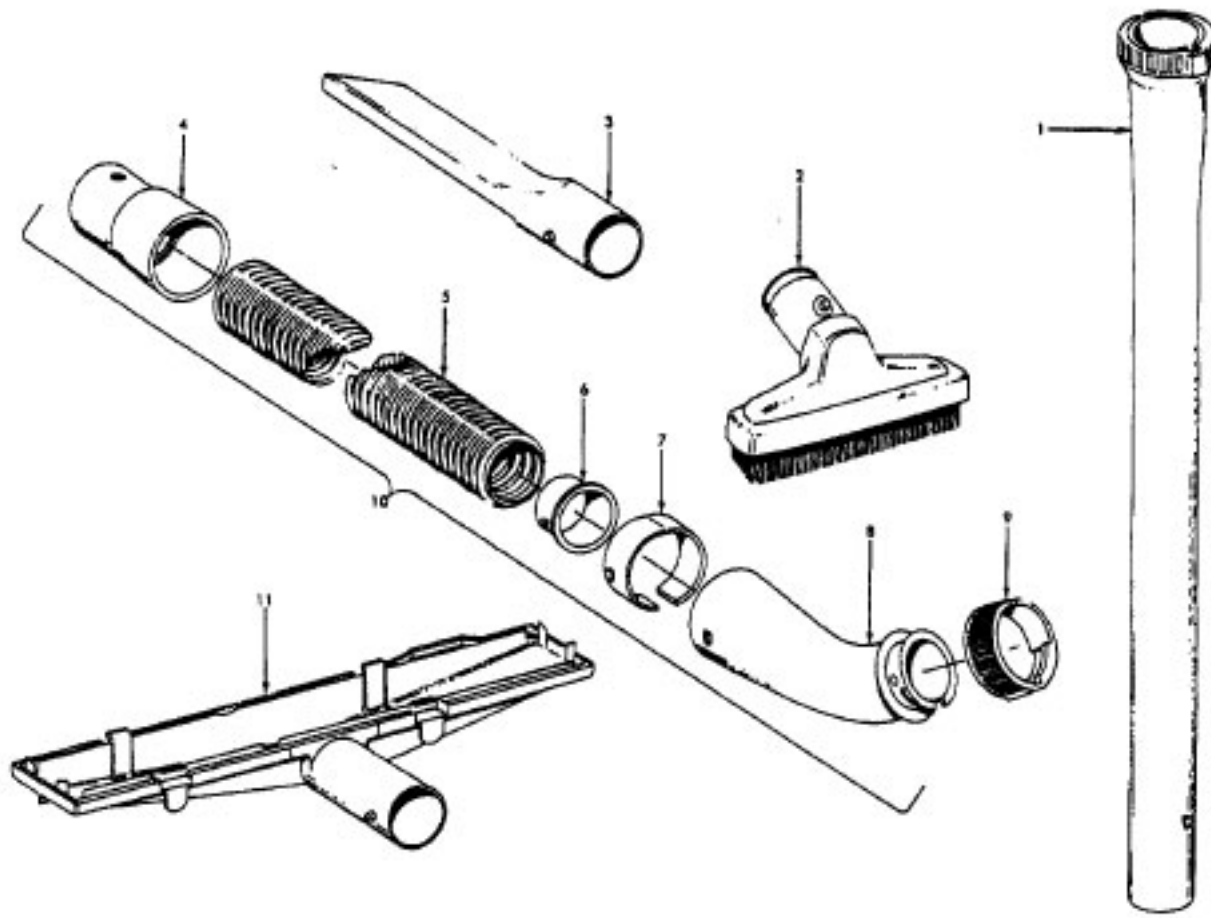

Standard Fit Tools (w/Retention Pin) (Shown)

Ref. No.	Part No.	Description
1	3863801P	Extension Tube - Poly - AG
2	43414016	Furniture Brush - AG
3	38617017	Crevice Tool - AG
4	32288004	Hose Connector - AAP
5	38671028	Hose - Less Ends - AAP
6	32158010	Hose Sleeve
7	36171025	Hose Connector Collar
8	43466058	Hose Connector - Curved - AAP (Incl. Item 9)
9	36153009	Latch Ring
10	43434210	Hose Comp.
11	38656016	Converter Body - AAP
	43414057	Furniture Nozzle - AG
	43414064	Dusting Brush - AG
	43414073	Wall/Floor Brush - AG

Friction Fit Tools (w/o Retention Pin)

38634078
Not Available
38617024
32288004
38671030
Not Available
Not Available
39454059 (Hand Grip)
Not Available
Not Available
38656016
38614029
43414145
43414135