

This Owner's Manual is provided and hosted by [Appliance Factory Parts](#).



CUISINART EM-200 Owner's Manual

[Shop genuine replacement parts for CUISINART
EM-200](#)



[Find Your CUISINART Small Appliance Parts - Select From 213 Models](#)

----- Manual continues below -----

Cuisinart® INSTRUCTION BOOKLET



Programmable Espresso Maker

EM-200

For your safety and continued enjoyment of this product, always read the instruction book carefully before using.

IMPORTANT SAFEGUARDS

We at Cuisinart are very safety conscious. We design and manufacture consumer products with the safety of you, our valued customer foremost in mind. In addition we ask that you exercise a degree of care when using electrical appliances and adhere to the following precautions.

When using electrical appliances, basic safety precautions should always be followed, including the following:

- 1. CAREFULLY READ ALL INSTRUCTIONS BEFORE OPERATING APPLIANCE AND SAVE FOR FUTURE REFERENCE.**
2. To protect against fire, electrical shock and injury to persons do not immerse the appliance, cord or plug in water or any other liquid.
3. This appliance is for household use only.
4. Do not use this appliance for anything other than its intended use.
5. This appliance should not be used by or near children or individuals with certain disabilities.
6. Do not leave the appliance unattended when in use.
7. Do not touch hot surfaces. Use handles.
8. Always use the appliance on a dry, level surface.
9. To disconnect, turn all controls off, then remove plug from power outlet.
10. Do not place this appliance on or near a hot gas or electric burner, or where it could touch a heated oven.
11. Do not let the cord hang over the edge of a table or counter, touch hot surfaces or become knotted.
12. The use of accessory attachments not recommended by Cuisinart may cause a risk of injury to persons, fire or electrical shock.
13. Strictly follow cleaning and care instructions.
14. Do not use this appliance for anything other than its intended use. Do not use in moving vehicles or boats.
15. Do not use outdoors.
16. Always switch the appliance off, and then remove plug from the power outlet when the appliance is not being used and before cleaning.
17. An extension cord is not recommended. However, if one is needed, the extension cord should be a grounded type and its electrical rating must be the same or higher wattage as the appliance. Regularly inspect the supply cord, plug and actual appliance for any damage. If found damaged in any way, immediately cease use of the appliance and call Cuisinart Customer Service at 1-800-726-0190.
18. For any maintenance other than cleaning, call Cuisinart Customer Service at 1-800-726-0190.
19. Refer servicing to qualified personnel.
20. Do not operate any appliance with a damaged cord or plug or after the appliance malfunctions, or has been damaged in any manner. Return appliance to the nearest authorized service facility for examination, repair or adjustment.
21. Unplug from outlet when not in use and before cleaning. Allow to cool before putting on or taking off parts, and before cleaning the appliance.

SAVE THESE INSTRUCTIONS FOR HOUSEHOLD USE ONLY

WARNING: RISK OF FIRE OR ELECTRIC SHOCK



The lightning flash with arrowhead symbol within an equilateral triangle is intended to alert the user to the presence of uninsulated dangerous voltage within the product's enclosure that may be of sufficient magnitude to constitute a risk of fire or electric shock to persons.



The exclamation point within an equilateral triangle is intended to alert the user to the presence of important operating and maintenance (servicing) instructions in the literature accompanying the appliance.

SPECIAL SAFETY INSTRUCTIONS

1. Use only cold water in the water reservoir. Do not use any other liquid.
2. Never use the machine without water in it.
3. Ensure the portafilter holder is firmly secured when using the machine.
4. Never remove the portafilter holder during the brewing operation as the machine is under pressure.

NOTE: For safety reasons it is recommended you plug your Cuisinart appliance directly into the power outlet. Use in conjunction with a power strip or extension cord is not recommended.

SPECIAL CORD SET INSTRUCTIONS

A short power-supply cord is provided to reduce the risks resulting from becoming entangled in or tripping over a longer cord.

Longer extension cords are available and may be used if care is exercised in their use.

If a long extension cord is used, the marked electrical rating of the extension cord must be at least as great as the electrical rating of the appliance, and the longer cord should be arranged so that it will not drape over the countertop or tabletop where it can be pulled on by children or tripped over.

NOTICE

This appliance has a polarized plug (one blade is wider than the other). To reduce the risk of electric shock, this plug will fit in a polarized outlet only one way. If the plug does not fit fully in the outlet, reverse the plug. If it still does not fit, contact a qualified electrician. Do not modify the plug in any way.

IMPORTANT UNPACKING INSTRUCTIONS

1. Open the gift box.
2. Remove the top corrugated cardboard.
3. Remove the entire unit from the box.
4. Remove the three filter baskets, scoop/tamping tool and portafilter holder from the side polyfoam.
5. Remove the frothing pitcher from the middle of the espresso maker and then remove the polyfoam from the espresso maker.

We suggest you save all packing materials in the event that future shipping of the machine is needed. Keep all plastic bags away from children.

CONTENTS

Important Safeguards	2
Unpacking Instructions	3
The Quest for the Perfect Cup of Espresso	4
Features and Benefits, Diagram	5
Preparing Your Espresso Machine Before Use	6
Programming Your Espresso Machine	6
Guide to the Perfect Espresso	7
Guide to Milk Texturing	8
Using the Hot Water Function	9
Cleaning and Maintenance	9
Recipes	11
Warranty	19

INTRODUCTION

Congratulations on the purchase of your new Cuisinart® Espresso Maker! You're only minutes away from experiencing the rich, flavorful espresso found in the world's best cafés, right in your own home. Please take a few moments to discover the features of your new espresso maker, including the double-shot option, and be sure to enjoy every espresso, cappuccino and latte to come!

THE QUEST FOR THE PERFECT CUP OF ESPRESSO

It is generally agreed that there are four basic elements critical to the perfect cup:

Element 1: Water

When brewing espresso, make sure the water flows through the filter at the correct pace. The water flow can be adjusted by varying the pressure with which the coffee is tamped (pressed down) in the filter or by altering the grind of the coffee. If the speed of the water flow is too slow, the coffee will be over-extracted and will be very dark and bitter, with a spotted and uneven crema (froth) on the top. If the speed of the water flow is too fast, the coffee will be under-extracted and the supreme flavor will not develop. The coffee will be diluted and there will be an inadequate amount of crema on the top.

Element 2: Coffee

While the bulk of the liquid is water, all of the flavor should be from the coffee. To achieve the same great quality of coffee you receive at a café, you need to use the same quality beans. If you choose to grind your own beans, buy the beans fresh and whole, only about a two-week supply at a time for maximum freshness. Once the coffee bean is broken, its flavor degrades very quickly. If it is not practical to buy smaller supplies, we recommend you separate larger amounts of beans and store them in airtight containers in a cool, dry area. They should not be kept for longer than 1 month as flavor will diminish. Do not refrigerate or freeze coffee beans

Element 3: Grind

The grind of the coffee is critical for proper flavor extraction. If using a pre-ground coffee, be sure to purchase an espresso grind that is specifically for espresso/cappuccino machines. If the grind is too fine, over extraction and bitterness will occur with a spotted and uneven crema on the top. If the grind is too coarse, the water will pass through too rapidly and there will be an inadequate amount of crema on the top of the espresso.

Element 4: Tamping the Coffee Grounds

If you choose to use ground espresso instead of pods, tamping the coffee is a very important part of the coffee making process. Use the scoop supplied to fill the filter basket, then using the tamping tool (flat end of the measuring scoop), tamp (press down) down the grounds with moderate pressure. Add more coffee and tamp again if necessary to bring coffee to level. Do not overfill the filter basket. The ground coffee should be tamped with moderate pressure. If the coffee is not tamped securely, there is a chance that the water will flow through the coffee too rapidly and the coffee will be under-extracted. **Note: If the coffee is tamped too firmly, the water will flow through the coffee too slowly and the coffee will be over-extracted.**

FEATURES AND BENEFITS

- 1. Water Reservoir Lid**
- 2. Removable 64-ounce Water Reservoir**
- 3. Cup-Warming Plate**
Used to warm the espresso cups.
- 4. 15 Bar Pump (not shown)**
- 5. Power Button**
Used to turn the espresso maker on. This button illuminates when pressed.
- 6. Manual Button**
Used for a continuous pour of espresso.
- 7. 1-cup Button** ☕
Used for a single serving of espresso – 1.5 ounces.
- 8. 2-cup Button** ☕☕
Used for a double serving of espresso – 3.0 ounces
- 9. Program Button**
Used to set the number of ounces desired.
- 10. Steam Button**
Used when making cappuccinos and lattes. Will flash until ready for use.
- 11. Portafilter Holder**
Can be used with ground or pod espresso. Has two positions, lock and unlock, for ease of cleaning.
- 12. Brew Head**
For easy fit of the portafilter holder.
- 13. Steam or Hot Water Control Dial**
Used to activate steam or hot water.
- 14. Commercial Steam Wand**
Use to steam milk for cappuccinos and lattes.
- 15. Removable Drip Tray**
Removable drip tray with grate.
- 16. Cleaning Pins**
Used to clean any excess milk that gets stuck inside the steam wand or any coffee particles that get stuck inside the filter basket.
- 17. Stainless Frothing Pitcher**
Used for steaming milk for cappuccinos and lattes.

- 18. Measuring Scoop/Tamping Tool**
Use one side as a coffee scoop and the other to tamp the coffee grinds in the filter basket prior to brewing.

- 19. Filter Baskets**
Use the one-cup filter basket for a single espresso and the two-cup filter basket for a double espresso, and pod filter basket for espresso pods.

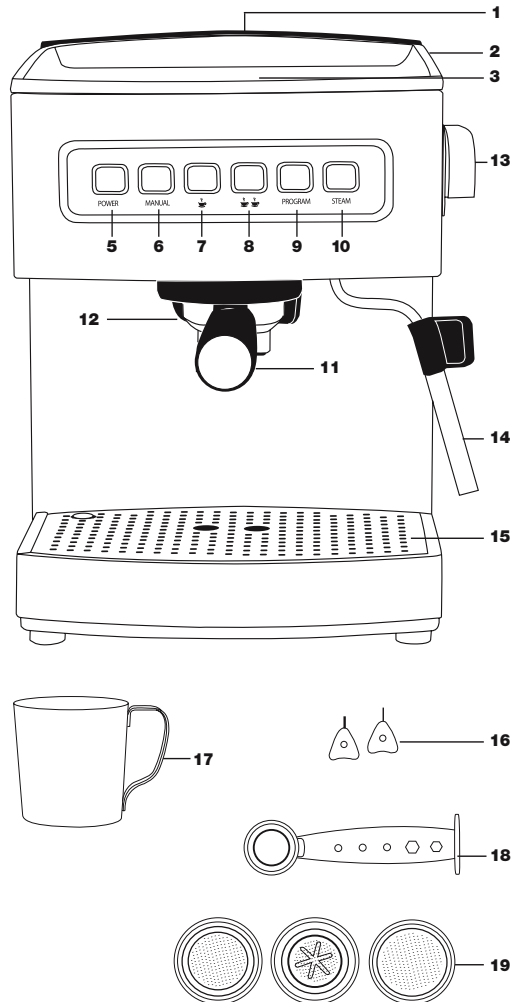

PREPARING YOUR ESPRESSO MACHINE

1. Place the espresso machine on a dry, stable countertop or other surface where you will be using the machine.

IMPORTANT: For first time use or if the machine has not been used for some time, it is important that the machine is rinsed as follows:

2. Insert the power cord into a power outlet. Press the power button once to turn the espresso machine on (1). The light around the power button is solid; this is to indicate that your espresso machine is on (2). The manual ☕ and ☕☕ buttons will flash to indicate that your espresso maker is heating up.

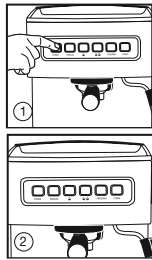

NOTE: Before turning on the espresso machine ensure that the steam and hot water control dial is in the **O** position.

WARNING: If the steam/hot water dial is not in the center position, the manual and steam buttons will flash until the dial is returned back to the center position.

3. Make sure the drip tray and grate are in place.

4. To fill the espresso machine with water, simply lift the lid of the water reservoir at the top of the espresso machine, (3) and fill with fresh cold water or filtered water (4) or remove the reservoir and replace the water reservoir firmly and close the lid (5).



5. Fit the portafilter holder with either the one cup, two cup or pod filter basket (6). Secure the portafilter handle to the brew head (7) (8).



6. Place a sufficiently large container under both pouring spouts. (9).
7. Press the manual button (10) and allow the water to run through for approximately 5 to 10 seconds.
8. Place cups on the warming plate (11).

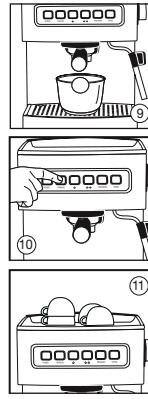

NOTE: If the water reservoir is empty, the unit will not function and the manual ☕ and ☕☕ buttons will flash until the reservoir is filled.

PROGRAMMING YOUR ESPRESSO MACHINE

The Cuisinart® Programmable Espresso Maker has programming capabilities. Based on café settings, the ☕ single and ☕☕ double espresso functions are set at 1.5 and 3.0 oz. However, by following a few simple steps, you can pre-program your perfect serving size down to the ounce.

Programming ☕ Single Espresso

1. Prepare the portafilter holder with the one cup filter basket (12) and fill with finely ground espresso (13). Using the tamping tool, tamp the coffee grinds (14), or use a single pod of espresso coffee with the pod filter holder. Secure the portafilter holder to the brew head (15-16).

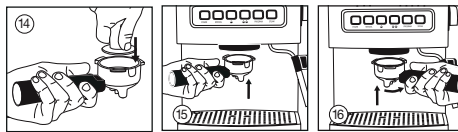
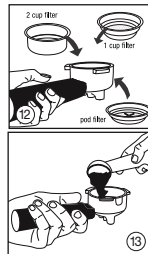

2. Place a cup under both pouring spouts.

3. To begin programming press the program button (17). The light around the program button will show a constant blue light.

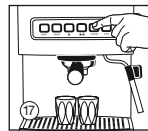

4. Press the ☕ single espresso button once to start the espresso pour (18). The light around the ☕ single espresso button will flash.

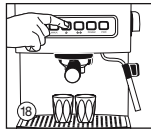

5. Allow the espresso to pour until it reaches the desired level. Once that is reached, stop the espresso pour by pressing the ☕ single espresso button. A beep will signify that the new setting for the ☕ single espresso operation has been programmed and stored in the machine's memory.
6. The espresso machine will then return to normal operation mode and is ready to make another espresso at the push of a button.

Programming ☕☕ Double Espresso

1. Prepare the portafilter holder. Fit it with the two-cup filter basket (12) and fill with finely ground coffee (13). Using the tamping tool, tamp the coffee grinds (14). Secure the portafilter holder to the brew head (15-16).

2. Place two cups under both pouring spouts.

3. To begin programming press the program button (17). The light around the program button will show a steady blue light.

4. Press the ☕☕ double espresso button once to start the espresso pour (18). The light around the ☕☕ button will flash.

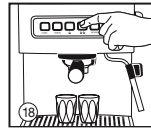

5. Allow the espresso to pour until it reaches the desired level. Once that level is reached, stop the espresso pour by pressing the ☕☕ double espresso button. A beep will signify that the new setting for the ☕☕ double espresso operation has been programmed and stored into the machine's memory.

6. The espresso machine will then return to normal operation mode and is ready to make another espresso at the push of a button.

Resetting the Factory Settings

To revert to the original factory settings:

1. Press the program button once.
2. Press and hold down the manual button and program.

3. Continue holding down manual and program buttons for approximately 3 seconds or until you hear 2 beeps. When you hear the 2 beeps, the light around the ☕ and ☕☕ buttons will flash, and after that, the program light becomes solid. The espresso machine has now returned to the original factory settings and the next time the single or double espresso functions are used the espresso pours will be 1.5 and 3.0 oz.

4. The espresso machine will then return to normal operation mode and is ready to make another espresso at the push of a button.

GUIDE TO THE PERFECT ESPRESSO

1. You may want to preheat the cups by filling them with hot water, this will help preserve the crema of the espresso. Set the cups aside.

2. Select the appropriate filter basket and insert it into portafilter handle (19).

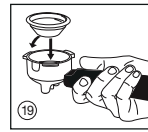

TIP: Use the one-cup filter basket for a single espresso, the two-cup filter basket for a double espresso, and pod filter basket for an espresso pod.

3. Using the measuring scoop, place finely ground coffee in the filter basket holder (20). Use one scoop for one cup and two scoops for two cups, or place espresso pod in filter basket.

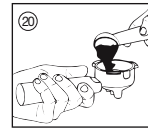

4. Rest the portafilter handle with the filter basket in position on the countertop. Using the tamping tool, apply a moderate packing pressure (21). Add more coffee and tamp again if necessary to bring coffee to level.

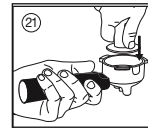

5. Brush any excess coffee grounds from around the edge of the filter basket (22).

IMPORTANT: Be sure not to overfill the filter basket with coffee.

TIP: Make sure the tamping tool is dry so that wet coffee grinds do not stick to it.

- Secure the portafilter holder to the brew head. (23-24).

NOTE: Check to see that the espresso machine is ready for use. Remember that if the power light is solid and the manual, ☺ and ☺☺ are solid, the espresso machine is on and is heating up and ready to brew coffee.

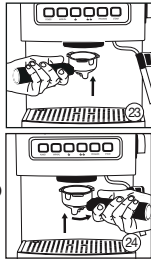

- Press the required volume button – manual for a continuous pour (25), the ☺ single espresso for a 1.5 oz. (26) or the ☺☺ double espresso for a 3.0 oz. (27).

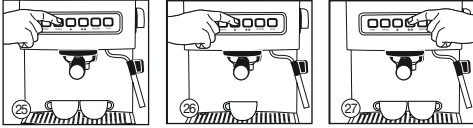

NOTE: When using the manual operation you must press the button once to start the pour and again to stop the pour. However, with the ☺ single and ☺☺ double espresso operations you need only press these buttons once to start the espresso pour and the program will automatically stop the pour at the pre programmed level.

- Check the espresso pour. The ideal pour is dark and caramel with reddish reflections.
- Serve espresso immediately.

Caring for your Espresso Maker

- Remove the portafilter handle from the brew head (28).

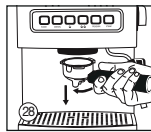

- Discard the used coffee grinds or pod/pods from the filter basket (29). Place the portafilter holder into lock position when discarding grinds so basket stays in place.

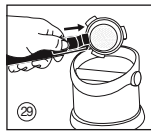

Sleep Mode

After 30 minutes of non-use the espresso machine will automatically switch to sleep mode. An indication that the machine is in sleep mode is that the power light will slowly flash. After a further 1½ hours of non-use, the espresso machine will turn off.

GUIDE TO MILK TEXTURING

Milk texturing is the steaming of milk. The steam does two things; it heats the milk and mixes air with the milk to form a foamy texture. As with learning to make an espresso, perfecting the art of milk texturing takes time and practice.

- Determine how much milk is needed based on the number of cups being made.

TIP: Keep in mind that the volume of milk will increase during the texturing.

- Pour cold refrigerated milk into the stainless frothing pitcher, between ½ to ¾ full.
- Press the steam button which will flash, and become solid when unit is ready for use.

- Purge the steam wand of any water. With the steam wand positioned over the drip tray, activate the steam function by turning the steam and hot water control dial to the left (30). Once any water has been purged stop the steam by turning the steam and hot water control dial to the center position (31).

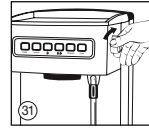
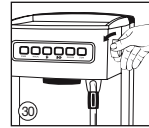

- Swing the steam wand to the side of the espresso machine (32).



- Place the steam wand into the milk so that the nozzle is about a half-inch below the surface and activate the steam function by turning the steam and hot water control dial to the ☺ setting (33).



7. Angle the pitcher so that the steam wand is resting on the spout of the pitcher and lower the pitcher until the tip of the steam nozzle is just below the surface of the milk. This will start to create a whirlpool action in the milk (34).

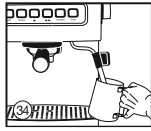

NOTE: Do not allow the steam to spurt unevenly or it will create aerated froth/large bubbles. If this is happening, raise the pitcher so that the steam nozzle is lowered farther into the milk.

8. As the steam heats and textures the milk, the level of the milk in the pitcher will begin to rise. As this happens, follow the level of the milk by lowering the pitcher, always keeping the tip of the steam nozzle just below the surface.

9. Once the foam is created, raise the pitcher until the steam nozzle is in the center of the milk (35).

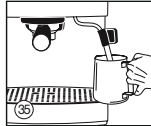

TIP: The amount of foam required will vary depending on the drinks being made. For example, a cappuccino requires more foam than a latte.

10. Stop the steam immediately by turning the steam and hot water control dial to the center position (36).



IMPORTANT: Do not boil the milk.

11. Remove the pitcher, immediately wipe the steam nozzle and wand with a clean damp cloth (37) and purge a small amount of steam.

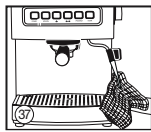

USING THE HOT WATER FUNCTION

1. Place the cup or container under the steam/hot water nozzle and activate the hot water function by turning the steam and hot water control dial to the hot water setting (38).

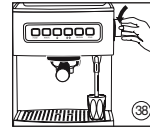

2. Once you have dispensed the required amount of hot water into the cup or container, stop the hot water by turning the steam/hot water control dial to the O position (39).

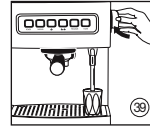

3. Remove the cup or container and swing the steam/hot water wand over the drip tray to catch any drips of water (40).

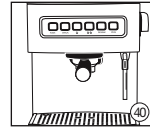

CLEANING AND MAINTENANCE

Always turn the espresso maker off and remove the plug from the electrical outlet before cleaning.

Never immerse unit in water or other liquid. To clean, simply wipe with a clean damp cloth and dry before storing.

CLEANING THE FILTERS, PORTAFILTER HOLDER AND BREW HEAD

- The stainless steel filters and portafilter holder should be rinsed under water immediately after use to remove all coffee particles. You may also use a cleaning pin to clear the opening.
- Periodically run water through the machine with the portafilter holder in place, but without any ground coffee, to rinse out any lingering coffee particles.
- The inside of the brew head should be wiped with a damp cloth to remove any coffee particles.

CLEANING THE OUTER HOUSING/CUP WARMING PLATE

- The outer housing and cup warming plate can be cleaned with a soft, damp cloth. Do not use any scouring agents or harsh cleaners.

CLEANING THE GRATE ON THE DRIP TRAY

- The grate should be removed, emptied and cleaned frequently, particularly when the drip tray is full.

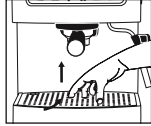

- The grate can be washed in warm soapy water and rinsed thoroughly. Use a non-abrasive washing liquid (do not use abrasive cleaners, pads or cloths which can scratch the surface).

CLEANING THE DRIP TRAY

- The drip tray can be removed after the grate is removed and then cleaned with a soft, damp cloth (do not use any scouring agents or harsh cleaners).



NOTE: Do not clean any of the parts or accessories in the dishwasher.

CLEANING THE STEAM WAND

- The steam wand should always be cleaned after steaming milk.

- Wipe the steam wand with a damp cloth, then with the steam wand directed back into the drip tray, momentarily set the steam and hot water control dial to the hot water setting. This will release any remaining milk from inside the steam wand.



- Make sure the steam and hot water control dial is in the off position. Press the power button off, unplug the power cord and allow the machine to cool.

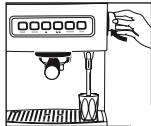

- If the steam wand remains blocked, use pin to clear the opening.

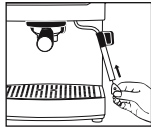

DECALCIFICATION

Decalcification refers to the removal of calcium deposits that form over time on the metal parts of the coffeemaker.

For best performance from your espresso maker, decalcify the unit from time to time. The frequency depends on the hardness of your tap water and how often you use the coffeemaker. To clean, fill the water reservoir to capacity with a mixture of $\frac{1}{3}$ white vinegar and $\frac{2}{3}$ water. Be sure the power button is in the off position, and the unit is unplugged. Remove the portafilter holder. Pour the decalcifying agent into the water reservoir, plug the machine back in, and power the unit back on. Set the power button to on and the function knob to the off position. Place a large container under the brew head and steam wand. When brewing temperature is reached, the heating light will switch off. Set the function knob to the espresso position (show icon of espresso cup) and let half of the solution run through the brew head. Set the function knob to steam position and allow the remaining solution to run through the steam wand. When the solution stops running, set the function knob back to the off position. After decalcifying, let one cycle of fresh cold water through the unit before using the unit again to brew coffee.

RECIPES

Classic Espresso

Makes 1 serving (1½ ounces)

- 1 measured scoop finely ground espresso or 1 espresso pod**
water

Press the power button of the Cuisinart® Espresso Maker to turn the machine on. The lights around the power, manual, single ☕ and ☕☕ double espresso buttons will illuminate and when they stop blinking, the machine has been warmed and is ready to use.

Place the one-cup filter basket in the portafilter holder. Spoon the espresso grounds into the basket. Using the tamping tool, lightly press down on the grounds and clean any excess from the rim. Secure the portafilter holder in place.

Place a demitasse cup underneath the brew head and press the ☕ single espresso button.

Espresso will begin to brew. When 1½ ounces have been brewed the machine will stop.

Doppio

Makes 1 serving (3 ounces)*

- 2 measured scoops finely ground espresso or 2 espresso pods**
water

Press the power button of the Cuisinart® Espresso Maker to turn the machine on. The lights around the power, manual, single ☕ and ☕☕ double espresso buttons will illuminate and when they stop blinking, the machine has been warmed and is ready to use.

Place the one-cup filter basket in the portafilter holder. Spoon the espresso grounds into the basket. Using the tamping tool, lightly press down on the grounds and clean any excess from the rim. Secure the portafilter holder in place.

Place one mug or glass underneath the brew head and press the ☕☕ double espresso button. Espresso will begin to brew. When 3 ounces have been brewed the machine will stop.

*This recipe can also be used to make two single espressos. Follow the same instructions for the doppio, but place two demitasse cups under the brew head instead of one.

Americano

Makes 1 serving (6-8 ounces)

- 1 measured scoop finely ground espresso or 1 espresso pod**

6-7 ounces hot water

Press the power button of the Cuisinart® Espresso Maker to turn the machine on. The lights around the power, manual, single ☕ and ☕☕ double espresso buttons will illuminate and when they stop blinking, the machine has been warmed and is ready to use.

Place the one-cup filter basket in the portafilter holder. Spoon the espresso grounds into the basket. Using the tamping tool, lightly press down on the grounds and clean any excess from the rim. Secure the portafilter holder in place.

Place a 6 to 8-ounce glass or mug on the drip tray underneath the steam wand. Turn the steam/hot water dial to the hot water setting. Allow water to flow into the cup/mug until it is about ⅔ full and turn dial back to off position. Press the power button to turn the espresso maker off.

Place the cup/mug with the hot water already in it underneath the brew head and press the button above the ☕ single espresso button.

Espresso will begin to brew. When 1½ ounces have been brewed the machine will stop.

Espresso Macchiato

Makes 1 serving (1½ ounces)

- 2 ounces skim milk**
- 1 measured scoop finely ground espresso or 1 espresso pod**
- water**

Pre-chill the frothing pitcher. Press the power button of the Cuisinart® Espresso Maker to turn the machine on. The lights around the power, manual, single ☕ and ☕☕ double espresso buttons will illuminate and when they stop blinking, the machine has been warmed and is ready to use.

Place the one-cup filter basket in the portafilter holder. Spoon the espresso grounds into the basket. Using the tamping tool, lightly press down on the grounds and clean any excess from the rim. Secure the portafilter holder in place.

Press the steam button and once the light stops blinking, it's ready for use.

Turn the steam/hot water dial to the steam setting. Pour the milk into the pre-chilled frothing pitcher. Hold the pitcher in one hand and place it under the steam wand so the bottom of the wand is just below the surface of the milk. Once the milk begins to increase in volume, lift the pitcher higher so the steam wand is immersed farther into the milk. Move the pitcher up and down a couple of times to achieve a nice foam.

Place demitasse cup underneath the brew head and press the button above the ☕ single espresso button.

Espresso will begin to brew. When 1½ ounces have been brewed the machine will stop.

Using a large spoon, place one tablespoon of the frothed milk on top of the espresso.

Espresso Breve

Makes 1 serving (3½ ounces)

- ¼ cup half & half**
- 1 measured scoop finely ground espresso or 1 espresso pod**
- water**

Press the power button of the Cuisinart® Espresso Maker to turn the machine on. The lights around the power, manual, single ☕ and ☕☕ double espresso buttons will illuminate and when they stop blinking, the machine has been warmed and is ready to use.

Place the one-cup filter basket in the portafilter holder. Spoon the espresso grounds into the basket. Using the tamping tool, lightly press down on the grounds and clean any excess from the rim. Secure the portafilter holder in place.

Place one demitasse cup underneath the brew head and press the ☕ single espresso button.

Espresso will begin to brew. When 1½ ounces have been brewed the machine will stop.

Pour the half & half into a microwave-safe glass or mug. Place in microwave on high for 1 minute. Pour the espresso into the same mug.

Cappuccino

Makes 1 serving (3½ ounces)

- 2 ounces skim milk**
- 1 measured scoop finely ground espresso or 1 espresso pod**
- water**

Pre-chill the frothing pitcher. Press the power button of the Cuisinart® Espresso Maker to turn the machine on. The lights around the power, manual, single ☕ and ☕☕ double espresso buttons will illuminate and when they stop blinking, the machine has been warmed and is ready to use.

Place the one-cup filter basket in the portafilter holder. Spoon the espresso grounds into the basket. Using the tamping tool, lightly

press down on the grounds and clean any excess from the rim. Secure the portafilter holder in place.

Turn the steam/hot water dial to the steam setting. Pour the milk into the pre-chilled frothing pitcher. Hold the pitcher in one hand and place it under the steam wand so the bottom of the wand is just below the surface of the milk. Press the steam button and while holding the pitcher at an angle, allow the steam to move the milk around. Once the milk begins to increase in volume, lift the pitcher higher so the steam wand is immersed farther into the milk. Move the pitcher up and down a couple of times to achieve a nice foam. When the foam has almost reached the top of the pitcher, press the power button to turn the espresso maker off.

Reserve steamed/frothed milk.

Turn the espresso maker back on. Wait for the machine to re-warm, if necessary. Place one demitasse cup underneath the brew head and press the ☕ single espresso button.

Espresso will begin to brew. When 1½ ounces have been brewed the machine will stop.

Spoon 2 to 3 tablespoons of frothed milk on top of the espresso.

Café Latte

Makes 1 serving (5½ ounces)

- 4 ounces skim milk**
- 1 measured scoop finely ground espresso or 1 espresso pod**
- water**

Pre-chill the frothing pitcher. Press the power button of the Cuisinart® Espresso Maker to turn the machine on. The lights around the power, manual, single ☕ and ☕☕ double espresso buttons will illuminate and when they stop blinking, the machine has been warmed and is ready to use.

Place the one-cup filter basket in the portafilter holder. Spoon the espresso grounds into the basket. Using the tamping tool, lightly press down on the grounds and clean any

excess from the rim. Secure the portafilter holder in place.

Turn the steam/hot water dial to the steam setting. Pour the milk into the pre-chilled frothing pitcher. Hold the pitcher in one hand and place it under the steam wand so the bottom of the wand is just below the surface of the milk. Press the steam button and while holding the pitcher at an angle, allow the steam to move the milk around. Once the milk begins to increase in volume, lift the pitcher higher so the steam wand is immersed farther into the milk. Move the pitcher up and down a couple of times to achieve a nice foam. When the foam has almost reached the top of the pitcher, press the power button to turn the espresso maker off. Reserve steamed/frothed milk.

Turn the espresso maker back on. Wait for the machine to re-warm, if necessary. Place one demitasse cup underneath the brew head and press the ☕ single espresso button.

Espresso will begin to brew. When 1½ ounces have been brewed the machine will stop.

Slowly pour the steamed milk into the glass to ½ below the top.

Mochaccino

Makes 1 serving (5½ ounces)

- 4 ounces skim milk**
- 1 measured scoop finely ground espresso or 1 espresso pod**
- water**
- 2 tablespoons chocolate syrup**
- bittersweet chocolate, shaved, or unsweetened cocoa powder, for garnish (optional)**

Pre-chill the frothing pitcher. Press the power button of the Cuisinart® Espresso Maker to turn the machine on. The lights around the power, manual, single ☕ and ☕☕ double espresso buttons will illuminate and when they stop blinking, the machine has been warmed and is ready to use.

Place the one-cup filter basket in the

portafilter holder. Spoon the espresso grounds into the basket. Using the tamping tool, lightly press down on the grounds and clean any excess from the rim. Secure the portafilter holder in place.

Turn the steam/hot water dial to the steam setting. Pour the milk into the pre-chilled frothing pitcher. Hold the pitcher in one hand and place it under the steam wand so the bottom of the wand is just below the surface of the milk. Press the steam button and while holding the pitcher at an angle, allow the steam to move the milk around. Once the milk begins to increase in volume, lift the pitcher higher so the steam wand is immersed farther into the milk. Move the pitcher up and down a couple of times to achieve a nice foam. When the foam has almost reached the top of the pitcher, press the power button to turn the espresso maker off. Reserve steamed/frothed milk.

Turn the espresso maker back on. Wait for the machine to re-warm, if necessary. Place one demitasse cup underneath the brew head and press the ☕ single espresso button.

Espresso will begin to brew. When 1½ ounces have been brewed the machine will stop.

Add the chocolate syrup and about 4 ounces of the steamed milk to the glass; stir. Spoon 1 to 2 tablespoons of the frothed milk on top. If desired, top with shaved chocolate or cocoa powder.

Café Mocha

Makes 1 serving (6 ounces)

- 4 ounces skim milk**
- 1 measured scoop finely ground espresso or 1 espresso pod**
- water**
- 1 tablespoon chocolate syrup**
- ¼ cup heavy cream, whipped to a medium-soft peak**
- bittersweet chocolate, shaved, or unsweetened cocoa powder, for garnish (optional)**

Pre-chill the frothing pitcher. Press the power button of the Cuisinart® Espresso Maker to turn the machine on. The lights around the power, manual, single ☕ and ☕☕ double espresso buttons will illuminate and when they stop blinking, the machine has been warmed and is ready to use.

Place the one-cup filter basket in the portafilter holder. Spoon the espresso grounds into the basket. Using the tamping tool, lightly press down on the grounds and clean any excess from the rim. Secure the portafilter holder in place.

Turn the steam/hot water dial to the steam setting. Pour the milk into the pre-chilled frothing pitcher. Hold the pitcher in one hand and place it under the steam wand so the bottom of the wand is just below the surface of the milk. Press the steam button and while holding the pitcher at an angle, allow the steam to move the milk around. Once the milk begins to increase in volume, lift the pitcher higher so the steam wand is immersed farther into the milk. Move the pitcher up and down a couple of times to achieve a nice foam. When the foam has almost reached the top of the pitcher, press the power button to turn the espresso maker off. Reserve steamed/frothed milk.

Turn the espresso maker back on. Wait for the machine to re-warm, if necessary. Place one demitasse cup underneath the brew head and press the ☕ single espresso button.

Espresso will begin to brew. When 1½ ounces have been brewed the machine will stop.

Fill a tall glass with the steamed milk, leaving about 2 inches at the top. Add the espresso and chocolate syrup. Top the drink off with about 2 tablespoons of the whipped cream. If desired, top with shaved chocolate or cocoa powder.

Iced Cappuccino

Makes 1 serving (4½ ounces)

- 2 ounces skim milk**
- 1 measured scoop finely ground espresso or 1 espresso pod**
- water**
- 3-4 ice cubes**
- 3 ounces cold whole milk**

Pre-chill the frothing pitcher. Press the power button of the Cuisinart® Espresso Maker to turn the machine on. The lights around the power, manual, single ☕ and ☕☕ double espresso buttons will illuminate and when they stop blinking, the machine has been warmed and is ready to use.

Place the one-cup filter basket in the portafilter holder. Spoon the espresso grounds into the basket. Using the tamping tool, lightly press down on the grounds and clean any excess from the rim. Secure the portafilter holder in place.

Turn the steam/hot water dial to the steam setting. Pour the milk into the pre-chilled frothing pitcher. Hold the pitcher in one hand and place it under the steam wand so the bottom of the wand is just below the surface of the milk. Press the steam button and while holding the pitcher at an angle, allow the steam to move the milk around. Once the milk begins to increase in volume, lift the pitcher higher so the steam wand is immersed farther into the milk. Move the pitcher up and down a couple of times to achieve a nice foam. When the foam has almost reached the top of the pitcher, press the power button to turn the espresso maker off. Reserve steamed/frothed milk.

Turn the espresso maker back on. Wait for the machine to re-warm, if necessary. Place one demitasse cup underneath the brew head and press the ☕ single espresso button.

Espresso will begin to brew. When 1½ ounces have been brewed the machine will stop.

In a tall glass, place 3 to 4 ice cubes. Pour the espresso over the ice; add the whole milk. Spoon 2 tablespoons of the frothed milk on top.

Frozen Mocha

Makes 1 serving (8 ounces)

- 2 measured scoops finely ground espresso or 2 espresso pods**
- water**
- 2 tablespoons grated bittersweet or semisweet chocolate**
- 1 teaspoon granulated sugar**
- ½ cup whole milk**
- 4 ice cubes**

Press the power button of the Cuisinart® Espresso Maker to turn the machine on. The lights around the power, manual, single ☕ and ☕☕ double espresso buttons will illuminate and when they stop blinking, the machine has been warmed and is ready to use.

Place the two-cup filter basket in the portafilter holder. Spoon the espresso grounds into the basket. Using the tamping tool, lightly press down on the grounds and clean any excess from the rim. Secure the portafilter holder in place.

Place a glass underneath the brew head and press the ☕☕ button. Espresso will begin to brew. When 3 ounces have been brewed the machine will stop.

Stir the chocolate and sugar into the hot espresso to dissolve. Pour the espresso mixture into the jar of a Cuisinart® Blender. Place the lid on and process on high. While the motor is running, drop the ice cubes in and continue to process until the mixture is homogenous, about 30 seconds.

Pour into a glass.

Frozen Latte

Makes 1 serving (8 ounces)

- 2 measured scoops finely ground espresso or 2 espresso pods**
- water**
- 1 teaspoon granulated sugar, optional**
- 2 tablespoons whole milk**
- 3 ice cubes**

Press the power button of the Cuisinart® Espresso Maker to turn the machine on. The lights around the power, manual, single ☕ and ☕☕ double espresso buttons will illuminate and when they stop blinking, the machine has been warmed and is ready to use.

Place the two-cup filter basket in the portafilter holder. Spoon the espresso grounds into the basket. Using the tamping tool, lightly press down on the grounds and clean any excess from the rim. Secure the portafilter holder in place.

Place a glass underneath the brew head and press the ☕☕ button. Espresso will begin to brew. When 3 ounces have been brewed the machine will stop.

Stir the sugar into the hot espresso to dissolve. Pour the espresso mixture and the milk into the jar of a Cuisinart® Blender. Place the lid on and process on high. While the motor is running, drop the ice cubes in and continue to process until the mixture is homogenous, about 30 seconds.

Pour into a glass.

Espresso Martini

Makes 4 servings

- 2 measured scoops finely ground espresso or 2 espresso pods**
- water**
- ¾ cup vodka**
- ½ cup + 1 tablespoon Kahlua®**
- ¼ cup + 1 tablespoon Tia Maria®**

½ **cup cold, brewed espresso**

6-8 ice cubes

Press the power button of the Cuisinart® Espresso Maker to turn the machine on. The lights around the power, manual, single ☕ and ☕☕ double espresso buttons will illuminate and when they stop blinking, the machine has been warmed and is ready to use.

Place the two-cup filter basket in the portafilter holder. Spoon the espresso grounds into the basket. Using the tamping tool, lightly press down on the grounds and clean any excess from the rim. Secure the portafilter holder in place.

Place two demitasse cups underneath the brew head. Program the espresso maker to brew 4 ounces and press the program button. Espresso will begin to brew and will stop when 4 ounces have been brewed. Cover the brewed espresso and place in refrigerator to chill.

When the espresso has fully chilled, pour it into a cocktail shaker filled with ice and add the liquors. Shake well and strain into individual martini glasses.

Granita

Makes 4 servings

- 4 measured scoops finely ground espresso**
- water**
- 2 tablespoons granulated sugar**
- heavy cream, whipped to a stiff peak**
- bittersweet or semisweet chocolate, shaved (optional)**

Press the power button of the Cuisinart® Espresso Maker to turn the machine on. The lights around the power, manual, single ☕ and ☕☕ double espresso buttons will illuminate and when they stop blinking, the machine has been warmed and is ready to use.

Place the two-cup filter basket in the portafilter holder. Spoon the espresso grounds into the basket. Using the tamping tool, lightly press down on the grounds and clean any

excess from the rim. Secure the portafilter holder in place.

Program the espresso maker to brew 8 ounces. Place a glass underneath the brew head and press the program button. Espresso will begin to brew and will stop when 8 ounces have been brewed. Repeat to brew 8 more ounces. Stir sugar into combined espresso to dissolve.

Pour the espresso mixture in a bowl. Cool to room temperature. Cover with plastic wrap and place in freezer. Every hour, for about 5 hours in total, scrape the mixture with a fork to allow crystals to form.

To serve, layer equal amounts of granita and whipped cream in a parfait glass. Garnish with shaved chocolate, if desired.

Affogato

Makes 2 servings

2 measured scoops finely ground espresso or 2 espresso pods

Water

2 scoops vanilla ice cream

Press the power button of the Cuisinart® Espresso Maker to turn the machine on. The lights around the power, manual, single ☕ and ☕☕ double espresso buttons will illuminate and when they stop blinking, the machine has been warmed and is ready to use.

Place the two-cup filter basket in the portafilter holder. Spoon the espresso grounds into the basket. Using the tamping tool, lightly press down on the grounds and clean any excess from the rim. Secure the portafilter holder in place.

Place two demitasse cups underneath the brew head and press the ☕☕ double espresso button. Espresso will begin to brew and will stop when 3 ounces have been brewed.

Place one scoop of ice cream in each of two individual dishes. Pour one espresso over each scoop of ice cream.

Espresso Gelato

Makes 4½ cups

2 measured scoops finely ground espresso or 2 espresso pods

water

3 cups whole milk

2 cups espresso beans

1 cup brewed espresso

10 large egg yolks

1 cup granulated sugar

pinch of salt

Press the power button of the Cuisinart® Espresso Maker to turn the machine on. The lights around the power, manual, single ☕ and ☕☕ double espresso buttons will illuminate and when they stop blinking, the machine has been warmed and is ready to use.

Place the two-cup filter basket in the portafilter holder. Spoon the espresso grounds into the basket. Using the tamping tool, lightly press down on the grounds and clean any excess from the rim. Secure the portafilter holder in place.

Program the espresso maker to brew 8 ounces of espresso. Place a cup underneath the brew head and press the program button. Espresso will begin to brew and will stop when 8 ounces have been brewed. Reserve.

Pour milk into a medium sized, heavy-bottomed saucepan. Over medium-low heat, gradually bring the milk to a boil. Turn the burner off and stir in the espresso beans. Let steep for 15 to 20 minutes. Strain; discard beans.

Add the espresso to the steeped milk. Over a medium-low heat, gradually bring to a boil.

While the milk/espresso mixture is heating, slowly whisk the sugar and salt into the yolks. Beat together until the mixture is light and thickened.

Once the milk/espresso mixture has reached a boil, slowly whisk ⅔ of it into the yolk mixture. Return the combined mixture to the remaining milk/espresso in the saucepan. Over a

medium-low heat, stirring constantly in a figure-eight rotation with a wooden spoon, heat the mixture until it coats the back of a spoon, about 4 minutes. This mixture must NOT boil or the eggs will overcook.

Strain into a container and cool to room temperature. Cover; refrigerate for 2 to 3 hours, or overnight.

Once properly chilled, process in a Cuisinart® Ice Cream Maker according to the unit's instructions.

Tiramisù

Makes 12 servings

- 4 scoops finely ground espresso or 4 espresso pods**
- water**
- 3 large eggs, separated**
- ¾ cup granulated sugar, divided**
- 1 tablespoon sweet Marsala wine**
- 1 (8-ounce) container mascarpone cheese**
- ½ cup chilled heavy cream**
- 1 teaspoon water**
- pinch of salt**
- 2 cups brewed espresso, cooled**
- 2 tablespoons dark rum (optional)**
- 24 Savoiardi (crisp Italian ladyfingers)**
- bittersweet chocolate, shaved, or unsweetened cocoa powder (for garnish)**

Press the power button of the Cuisinart® Espresso Maker to turn the machine on. The lights around the power, manual, single ☺ and ☺☺ double espresso buttons will illuminate and when they stop blinking, the machine has been warmed and is ready to use.

Place the two-cup filter basket in the portafilter holder. Spoon the espresso grounds into the basket. Using the tamping tool, lightly press down on the grounds and clean any excess from the rim. Secure the portafilter holder in place.

Whisk together yolks and ½ cup sugar in a large bowl over a simmering pot of water. Whisk in Marsala. Continue whisking until the mixture is thick and pale and warm to the touch.

With a Cuisinart® Hand Mixer with the beaters attached and using the lowest speed, beat in the mascarpone cheese, until just combined. Reserve.

Using the whisk attachment of the hand mixer, beat the cream to a soft peak. Gently fold in the whipped cream to the mascarpone mixture until just combined, but still streaky.

In another bowl, beat the egg whites, salt, and water, with a cleaned whisk attachment on the hand mixer, to a soft peak. While still beating, gradually add the remaining sugar and beat to a medium-stiff peak. Gently fold the meringue into the mascarpone/cream mixture.

In a shallow bowl, mix the espresso and rum. Dip 1 ladyfinger in, soaking each side for a few seconds, and transfer to an 8-inch (2-quart) glass baking dish. Repeat with 11 more and arrange in the bottom of the dish, trimming if necessary to cover the entire surface. It should be a tight fit. Spread half of the mascarpone/meringue mixture over the soaked ladyfingers. Make another layer of ladyfingers and spread an even layer of the remaining mascarpone mixture on top. Cover with plastic wrap and chill for at least 6 hours.

Before serving, sprinkle with the shaved chocolate or the cocoa powder.

WARRANTY

LIMITED THREE-YEAR WARRANTY

This warranty supersedes all previous warranties on the Cuisinart® Programmable Espresso Maker.

This warranty is available to consumers only. You are a consumer if you own a Cuisinart® Programmable Espresso Maker that was purchased at retail for personal, family or household use. Except as otherwise required under applicable state law, this warranty is not available to retailers or other commercial purchasers or owners.

We warrant that your Cuisinart® Programmable Espresso Maker will be free of defects in material or workmanship under normal home use for three years from the date of original purchase.

We suggest that you complete and return the enclosed product registration card promptly to facilitate verification of the date of original purchase. However, return of the product registration card is not a condition of these warranties. In the event that you do not have proof of purchase date, the purchase date for purposes of this warranty will be the date of manufacture.

If your coffeemaker should prove to be defective within the warranty period, we will repair it (or, if we think it necessary, replace it) without charge to you. To obtain warranty service, please call our Consumer Service Center toll-free at 800-726-0190 or write to:

Cuisinart
150 Milford Road
East Windsor, NJ 08520

To facilitate the speed and accuracy of your return, please also enclose \$10.00 for shipping and handling of the product (California residents need only supply proof of purchase and should call 1-800-726-0190 for shipping instructions). Please also be sure to include a return address, description of the product defect, product serial number, and any other information pertinent to the product's return. Please pay by check or money order.

Your Cuisinart® Programmable Espresso Maker has been manufactured to strict specifications and has been designed for use with the

Cuisinart® coffeemaker authorized accessories and replacement parts for your model.

These warranties expressly exclude any defects or damages caused by accessories, replacement parts or repair service other than those that have been authorized by Cuisinart.

These warranties exclude all incidental or consequential damages. Some states do not allow the exclusion of or limitation of incidental or consequential damages, so the foregoing limitation or exclusion may not apply to you.

CALIFORNIA RESIDENTS ONLY

California law provides that for In-Warranty Service, California residents have the option of returning a nonconforming product (A) to the store where it was purchased or (B) to another retail store which sells Cuisinart products of the same type. The retail store shall then, according to its preference, either repair the product, refer the consumer to an independent repair facility, replace the product, or refund the purchase price less the amount directly attributable to the consumer's prior usage of the product. If the above two options do not result in the appropriate relief to the consumer, the consumer may then take the product to an independent repair facility if service or repair can be economically accomplished. Cuisinart and not the consumer will be responsible for the reasonable cost of such service, repair, replacement, or refund for nonconforming products under warranty.

California residents may also, according to their preference, return nonconforming products directly to Cuisinart for repair or, if necessary, replacement by calling our Consumer Service Center toll-free at 800-726-0190. Cuisinart will be responsible for the cost of the repair, replacement, and shipping and handling for such nonconforming products under warranty.

BEFORE RETURNING YOUR CUISINART PRODUCT

Important: If the nonconforming product is to be serviced by someone other than Cuisinart's Authorized Service Center, please remind the servicer to call our Consumer Service Center to ensure that the problem is properly diagnosed, the product serviced with the correct parts, and to ensure that the product is still under warranty.

Cuisinart®

SAVOR THE GOOD LIFE®



Cuisinart offers an extensive assortment of top quality products to make life in the kitchen easier than ever. Try some of our other countertop appliances and cookware, and Savor the Good Life®.

www.cuisinart.com

©2006 Cuisinart
Cuisinart® is a registered
trademark of Cuisinart

150 Milford Road
East Windsor, NJ 08520
Printed in China

06CU26371

Any other trademarks or service marks referred to herein are the trademarks or service marks of their respective owners.

IB-7262