

This Owner's Manual is provided and hosted by [Appliance Factory Parts](http://www.appliancefactoryparts.com).



CUISINART CEK-40 Owner's Manual

[Shop genuine replacement parts for CUISINART
CEK-40](#)



[Find Your CUISINART Small Appliance Parts - Select From 213 Models](#)

----- Manual continues below -----



ELECTRIC KNIFE

CEK-40

IMPORTANT SAFEGUARDS

When using an electrical appliance, basic safety precautions should always be followed:

1. **READ ALL INSTRUCTIONS.**
2. To protect against risk of electrical shock, do not put the knife handle in water or other liquid. If handle or cord falls into liquid, unplug the cord from outlet immediately. Do not reach into the liquid.
3. To avoid possible accidental injury, close supervision is necessary when any appliance is used by or near children.
4. Unplug from outlet when not in use, before putting on or taking off parts, and before cleaning.
5. Avoid contact with moving parts. Keep hands, hair, clothing and other utensils away from blade during operation to reduce risk of injury to persons and/or damage to the knife.
6. Do not operate any appliance with a damaged cord or plug or after the appliance has malfunctioned or has been dropped or damaged in any way or is not operating properly. Return the appliance to the nearest Cuisinart Repair Center for examination, repair, mechanical or electrical adjustment.
7. The use of attachments not recommended by Cuisinart may cause fire, electrical shock, or risk of injury.
8. Do not use outdoors or anywhere the

cord or knife might come into contact with water while in use.

9. To avoid the possibility of the knife being accidentally pulled off work area, which could result in damage to the knife or personal injury, do not let cord hang over edge of table or counter.
10. To avoid damage to cord and possible fire or electrocution hazard, do not let cord contact hot surfaces, including a stove.
11. Do not operate knife in water or under running water.
12. Unplug cord from outlet when inserting, removing or changing blades.
13. Blades are sharp. Handle carefully. Always handle blades with hand away from cutting edge. Always store blades with cutting edge away from you.

SAVE THESE INSTRUCTIONS FOR HOUSEHOLD USE ONLY

NOTICE:

This appliance has a polarized plug (one prong is wider than the other). As a safety feature, this plug will fit into a polarized outlet only one way. If the plug does not fit fully in the outlet, reverse the plug. If it still does not fit, contact a qualified electrician. Do not attempt to defeat this safety feature.

UNPACKING INSTRUCTIONS

IMPORTANT PLEASE READ

This package contains a Cuisinart® Electric Knife with the following parts:

- Knife Handle
- Carving Blade
- Bread Blade
- Butcher Block Wood Stand and
- Instruction Booklet

To avoid any injury to yourself or damage to the Cuisinart® Electric Knife, please follow these unpacking instructions:

1. Place the gift box containing your Cuisinart® Electric Knife on a flat, sturdy surface before unpacking.
2. Remove the Instruction Booklet and other printed materials.
3. Next, turn the box on its side and slide the entire unit out including packing materials.
4. Carefully remove the power cord from the cavity on the outside of the plastic foam insert.
5. Lift the plastic foam insert off the wooden butcher block stand.
6. Place the unit on a counter or table and read the instructions thoroughly before using.
7. Save shipping carton and inserts for later use.

NOTE: Remember to return your warranty card with all information carefully and completely filled out.

CONTENTS

Introduction	pg.3
Features & Benefits	pg.3
Use & Care	pg.4
Cleaning & Storage	pg.5
Helpful Hints	pg.5
How To Carve a Turkey	pg.5
Best Methods of Slicing Bread	pg.6
How To Carve Ham on the Bone	pg.7
Warranty	pg.7

INTRODUCTION

The Only Way To Slice It!

Whether you are making a large Thanksgiving dinner for your friends and family or slicing bread for early morning toast, the Cuisinart® Electric Knife will serve you well. Its superior cutting performance, state-of-the-art features and butcher block storage stand will spoil you for any other knife. Two full size blades quickly and evenly slice through roasts and bread. The stainless steel blades provide stay-sharp, long term performance. The Cuisinart® Electric Knife is built with the same commitment to the home cook as all other fine Cuisinart® kitchen products.

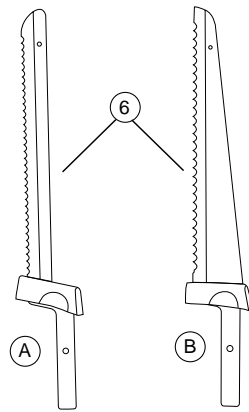
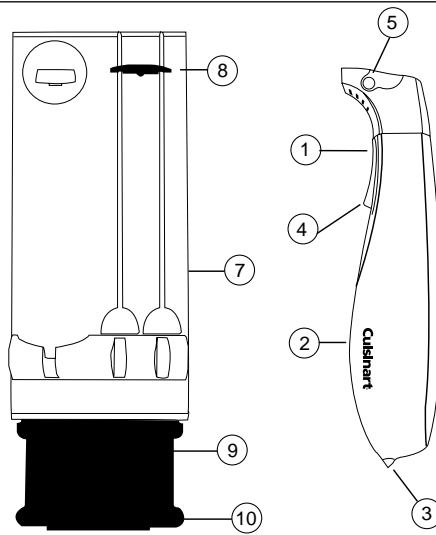

FEATURES AND BENEFITS

- 1. On/Off Control:**
One touch pressure activated on/off trigger control for simple operation. Convenient for left or right hand use.
- 2. Handle:**
Elegant ergonomic handle reflects look and feel of fine cutlery.
- 3. Electrical cord:**
4 foot cord for maximum flexibility.
- 4. Safety Button:**
One touch locks or unlocks the on/off control for safety. Keep the safety button locked when knife is not in use.
- 5. Blade Release Buttons:**
Easy inserting, removing or changing blades.
- 6. Blades:**
Two full size blades. (A) Carving Blade and (B) Bread blade.
- 7. Solid Wood Butcher Block:**
Premium unit crafted from hardwood. For easy, attractive storage on countertop or in drawer.
- 8. Blade Lock:**
Safely locks blades to wood block.
- 9. Cord Storage:**
Eliminates countertop clutter.
- 10. Base:**
For countertop storage.

USE AND CARE

Assembling the Butcher Block:

1. Push base toward the underside of butcher block and insert the tab on the bottom of the base into the slot on the edge of the block.
2. Stand unit on counter for easy access.
3. Reverse steps 1 and 2 for in-cabinet storage.

Note: Do not use Butcher Block as a cutting board.

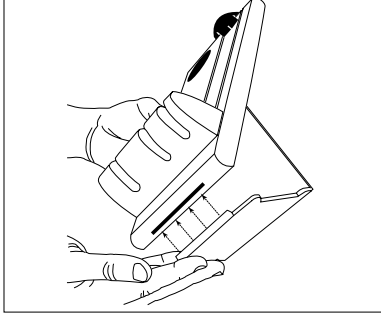

Assembling the Blades:

1. Lift and turn blade lock to a vertical position to remove blades from base. Remove protective sleeves. Before first use, separate the blades and wash them in hot, soapy water or the dishwasher. **CAUTION: BLADES ARE SHARP. HANDLE WITH CARE.** Dry thoroughly. (See Cleaning Instructions on page 4.)

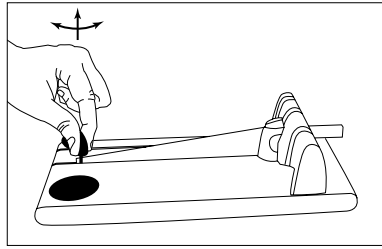

2. Attach the blades by inserting the rivet on one blade into the keyhole of the other blade.

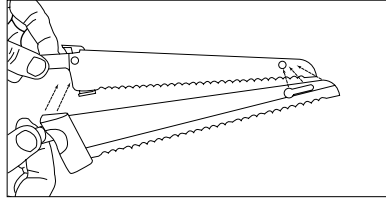

Using your Cuisinart® Electric Knife:

1. The knife should be unplugged when fitting the blades. The blades must be assembled before fitting into knife. The safety button should be in the locked position. Achieve this by pushing the small tab on the side of the trigger button. (While looking at the underside of handle, push the tab on the left side to unlock.)

While holding the blades with the serrated edge away from you, insert blades until you hear a "click". The blades may not line up evenly when properly inserted.

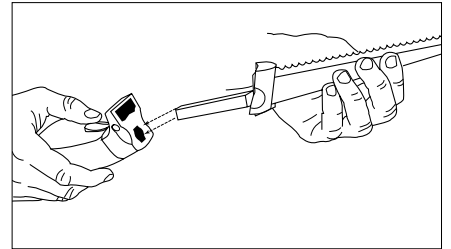

Caution: The blades are very sharp; be careful when handling them.

2. Plug the cord into a standard electrical outlet.
3. Unlock the safety button.
4. Squeeze and hold the trigger button with your fingers as you cut. Blades should stay parallel to the cutting surface.

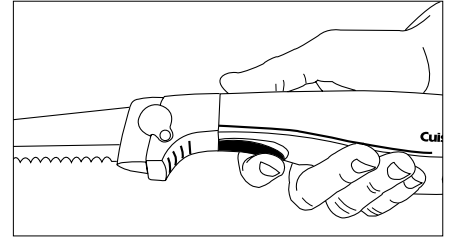

Caution: NEVER place your hand on top of the blade to support it while operating the knife as the blades are designed to move back and forth.

5. Blade automatically stops when trigger is released.

CLEANING AND STORAGE

1. To remove the blades, unplug the knife. Lock the safety button. Squeeze the Blade Release Buttons on both sides of the handle and grasp the blades with the cutting edge away from you. Slowly pull blades out from knife handle.
2. To wash, separate the blades by sliding the rivet out of the keyhole. Wash them in hot, soapy water or the dishwasher and dry thoroughly. Return to butcher block tray. Lift and turn blade lock positioning over blades and release to lock blades into position.
3. Clean the handle with a slightly damp cloth and wipe dry. Insert in butcher block and hook into slits on head of handle. Wrap cord around black base area.

Caution: Do not clean handle with blades in place. Do not immerse the appliance in water or other liquid or place it under running water.

HELPFUL HINTS

Carving Blade:
The carving blade is very versatile. In addition to slicing meats such as turkey, chicken, salami, ham and roasts, it can also be used to cut fruits like melon and pineapple, vegetables such as squash, eggplant and zucchini, as well as hard cheeses.

Bread Blade:
The bread blade glides through loaves for consistent, even slicing. It can also be used to slice bagels and sandwich rolls. Blade is intended for use on bread only.

HOW TO CARVE A TURKEY

Carving a large bird, especially in front of hungry guests, can be a daunting task—the watering mouths, critical eyes, rumbling stomachs. With the Cuisinart® Electric Knife, a little guidance and some helpful hints...we hope to make this task a pleasurable experience.

Preparation:

1. Remove the turkey from the oven.
2. Cover loosely with foil and let stand 15-30 minutes to let the juices set and the meat firm up. The turkey will be more moist, easier to carve, and the slices will hold together better.
3. Remove the stuffing.
4. Place turkey on a carving board, breast side up, with the legs facing you. You'll need your Cuisinart® Electric Knife and a large carving fork to hold the bird.

Cutting the legs and wings:

1. Hold the tip of one drumstick with your fingers and gently pull the leg away from the body of the turkey.
2. Holding the turkey steady with a carving fork, cut the skin between the thigh and the breast.

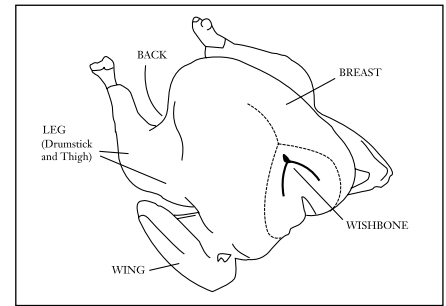

3. Pull the leg out further to expose the joint where the thigh connects and cut through joint with the knife to remove the leg.

Tip: The key to carving the thighs, legs, and wings is to cut through the joints, and not through the bones. **We do not recommend using your Cuisinart® Electric Knife on bones as it could cause damage to the knife or personal injury.**

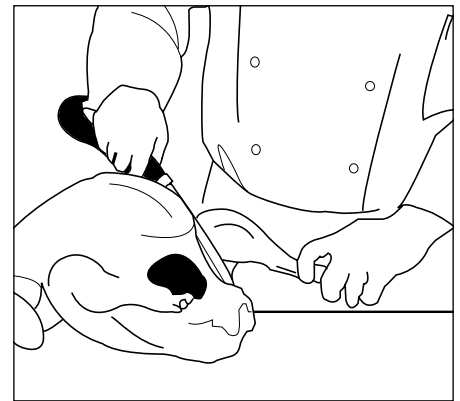

4. Next, hold the drumstick with the fork and cut at the joint between the drumstick and thigh to separate the two pieces.
5. Slice the meat on the drumstick by cutting along the bone to get thick slices.
6. Turn the drumstick and continue slicing along the bone until all of the meat is removed.
7. To remove meat from the thigh, cut thick slices to the bone. If the turkey is small, the drumstick and thigh may be served whole.
8. Using the fork, hold the wing away from the body and cut through the joint. The wing can be served as is.
9. Repeat on other side to remove leg and wing.

Tip: Cut dark meat first, as it does not dry out as quickly as the white meat of the breast.

Carving the breast:

1. Hold the breast with the carving fork, and starting at the outer side of one breast, cut slices parallel to the ribcage, from the top of the breast downward. The slices should be thin, even and the entire length of the breast. The slices will get larger as you work toward the ribcage. Continue slicing until you reach the bones.
2. Repeat on the other side of the breast.

Tip: Angle the knife parallel to the ribcage, rather than digging into the meat.

Tip: Some yummy leftovers that can be made from the smaller pieces of meat near the bones include: soup, casserole, chili, salad, tacos, etc.

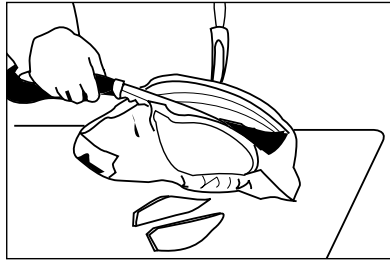

BEST METHODS OF SLICING BREAD

How to cut bread:

There are several ways to cut bread. Two of the most popular are to cut straight across, or in a herringbone pattern, which works only with rounded loaves of bread.

Standard slices:

1. First, to cut the bread straight across, place the loaf on a carving board.
2. Holding the bread firmly yet gently in one hand, place the knife over the bread, parallel to the carving board, making sure the tip of the knife extends past the side of loaf.
3. Cut slices to preference.

Tip: The Cuisinart® Electric Knife works well on bread by gently pulling the knife towards you as it cuts downward through the bread.

Herringbone pattern:

Cutting bread in a herringbone pattern is more difficult and produces smaller pieces of bread, although you still control the thickness of the slice.

1. To begin, hold the bread firmly yet gently in one hand and angle the knife across the corner of one of the smaller ends of the loaf, making sure the blade is parallel to the carving board. The slice should start in the middle of the loaf and angle towards the outside, cutting off the rounded crust.
2. The next slice starts again from the center of the loaf but angles toward the other side of the bread, cutting off a larger slice with crust.
3. Repeat step one, alternating cutting each side at an angle.

Tip: To cut in the herringbone pattern, you may need to turn the bread or vary your stance as you switch cutting sides.

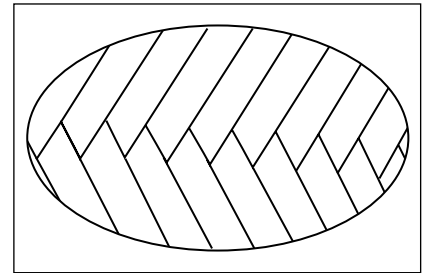

HOW TO CARVE HAM ON THE BONE

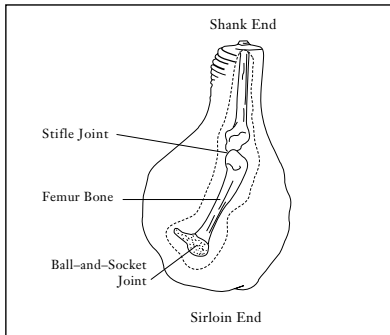

1. Remove the ham from the oven, cover loosely with foil and let stand for 20 minutes.
2. Place ham on a carving board.
3. Holding the ham steady with a carving fork, use your Cuisinart® Electric Knife to trim away the excess fat from the outside of the ham.
4. Next, stand the ham on end, holding the shank (smaller) end in your hand.
5. Slice into the ham just below the shank, at the stifle joint, where the ham gets bigger.
6. Cut along the bone, which is curved, and then around the socket joint at the sirloin end. The meat will not cut completely away from the bone yet.

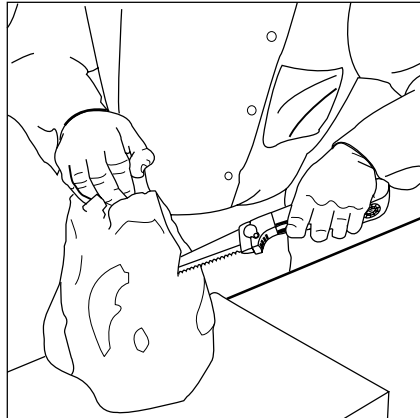

7. Rotate the ham so the uncut side is up, and holding the shank end with your hand, slice into the ham at the joint, cutting downward until the meat falls away from bone.
8. Cut off any large remaining pieces of meat. Carve the ham in even slices, keeping your knife parallel to the carving board and holding the ham securely with a carving fork.

WARRANTY

The Cuisinart® Electric Knife carries a Three (3) Year Limited Warranty.

This warranty is available to consumers only. You are a consumer if you own a Cuisinart® Electric Knife which was purchased at retail for personal, family or household use. Except as otherwise required under applicable law, this warranty is not available to retailers or other commercial purchasers or owners.

We warrant that your Cuisinart® Electric Knife will be free of defects in materials and workmanship under normal home use for 3 years from the date of original purchase.

If your Cuisinart® Electric Knife should prove to be defective within the warranty period, we will repair it, without charge to you.

To obtain warranty service please call toll-free 1-800-726-0190 or write to Cuisinart, 150 Milford Road, East Windsor, NJ 08520.

To facilitate the speed and accuracy of your return, please also enclose \$5.00 US (California residents need only supply a proof of purchase and should call 1-800-726-0190 for shipping instructions). Please be sure to include a return address, description of the product's problem, product serial number, and any other information pertinent to the product's return. Please pay by check or money order.

This warranty does not cover any damage caused by accident, misuse, shipment or other than ordinary household use.

This warranty excludes all incidental or consequential damages. Some states do not allow the exclusion or limitation of these damages, so they may not apply to you.

Cuisinart®

SAVOR THE GOOD LIFE™



COFFEE
MAKERS



FOOD
PROCESSORS



TOASTERS



HAND
MIXERS



BLENDERS



COOKWARE



ICE CREAM
MAKERS

Cuisinart offers an extensive assortment of top quality products to make life in the kitchen easier than ever. Try some of our other countertop appliances and cookware, and Savor the Good Life™.

www.cuisinart.com

© 2000 Cuisinart
Cuisinart® is a registered
trademark of Cuisinart
150 Milford Road
East Windsor, NJ 08520
Printed in China
00CU13138

IB-3770A