

This Owner's Manual is provided and hosted by [Appliance Factory Parts](http://ApplianceFactoryParts.com).

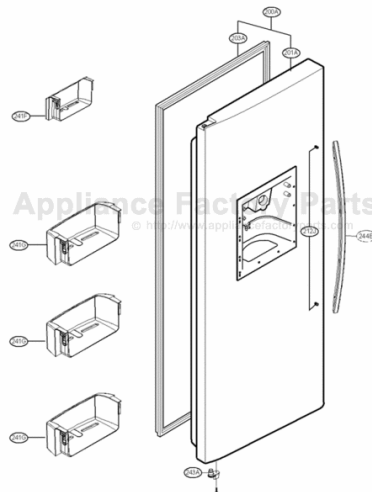

Kenmore 795.51023010 Owner's Manual

[Shop genuine replacement parts for Kenmore
795.51023010](#)



1/10

[Find Your Kenmore Refrigerator Parts - Select From 665 Models](#)

----- Manual continues below -----

FAILURE DIAGNOSIS TABLE

Error Code Diagnosis

To check for any error in the display, press and hold ULTRA ICE button and FRZ TEMP button for more than 3 seconds. If all LEDs are illuminated, no error is present; if only certain LEDs are illuminated, an error has occurred. For error listing refer to the table below.

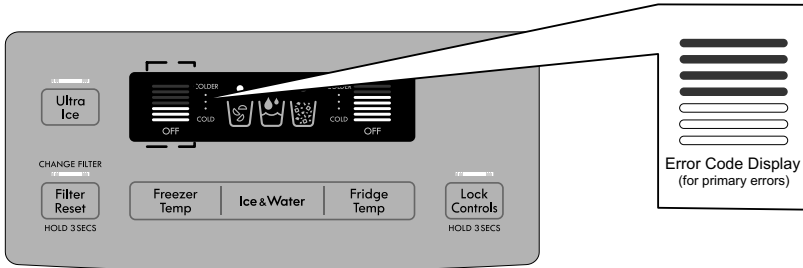

Fig. 1 (Type 1)

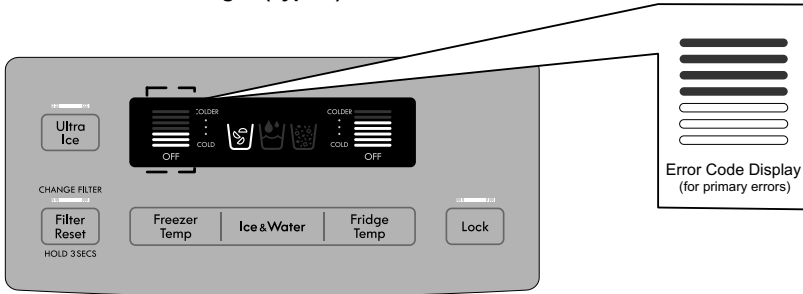

Fig. 2 (Type 2)

NOTE: Display type 1 or type 2 are determined by dispenser selection area. For type 1, only a dot will be illuminated above icon; for type 2, icon will be illuminated completely.

ERROR CODES displayed on Freezer Temp. indicator lights.

No.	ITEM	FAILURE CODE INDICATOR (F-Section)	CONTENTS OF FAILURE	PRODUCT OPERATION STATUS IN FAILURE				
				Compressor	Freezer Fan	Cooling Fan	Defrost Heater	STEP MOTOR
1	No Error	ALL LED ON	-	●	●	●	●	●
2	Freezer Sensor		Short circuit wire	15min ON / 15min OFF	Standard RPM	●	●	●
3	Refrigerator Sensor (1)			●	Standard RPM	●	●	10 min OPEN / 15min CLOSE
4	Refrigerator Sensor (2)	SEE SECONDARY ERROR INDICATOR LIGHT		●	●	●	●	●
5	Defrost Sensor			●	Standard RPM	●	No Defrost	●
6	Room Temperature Sensor	SEE SECONDARY ERROR INDICATOR LIGHT		●	●	●	●	●
7	Ice-maker Sensor	SEE SECONDARY ERROR INDICATOR LIGHT		●	●	●	●	●
8	Defrost			Defrost heater , fuse melting, short circuit, unplugged connector (error indicated 80 min after trouble).	●	Standard RPM	●	●
9	Ice-maker UNIT	SEE SECONDARY ERROR INDICATOR LIGHT	Faulty Ice-maker unit; Motor or Hall IC; Lead wire short circuit; Faulty Motor driver.	●	●	●	●	●
10	Freezing BLDC Fan Motor		Motor defect, hooked of lead wire to fan, contact of structures with fan, short or open of lead wire (there is no signal of BLDC Motor for more than 115s when fan motor is in operation).	●	Off (Re-check after 30min)	●	●	●
11	Cooling BLDC Fan Motor		-	●	●	Off (Re-check after 30min)	●	●

● = Normal Status

Primary Error: Freezer sensor, Refrigerator sensor (1), Defrost sensor, Freezer and Cooling Fan error.
Secondary Error: Refrigerator sensor (2), Room temperature sensor, Ice-maker sensor, Ice-maker unit error.

Primary errors and secondary errors can be checked in display by pressing and holding ULTRA ICE button and FRZ TEMP button simultaneously for more than 3 seconds (Display check mode); except when any primary error is present for more than 3 hours, in this case, error will be showed automatically in display without having to press any button.

SECONDARY ERROR INDICATOR LIGHT:

REFRIGERATOR SENSOR (2) (LOWER SENSOR IN REFRIGERATOR COMPARTMENT).....	“ULTRA ICE” INDICATOR WILL NOT BE LIT
ICE-MAKER SENSOR.....	“CUBE ICE” INDICATOR WILL NOT BE LIT
ICE-MAKER UNIT.....	“CRUSH ICE” INDICATOR WILL NOT BE LIT
ROOM TEMPERATURE SENSOR.....	“FREEZER TEMPERATURE LOWER” INDICATOR WILL NOT BE LIT.

PCB TEST BUTT

Main PCB

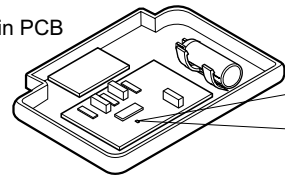

NOTE: Test mode will not begin if an error code is present.

NOTE: During the Test mode, display board buttons are disabled.

• After finishing the Test mode, always unplug and power off the unit.

MODE	OPERATION	COMPONENTS
TEST MODE 1	Press once TEST S/W <Forced Freezing Mode>	1. COMP & C Fan 2. Freezer fan in ON 3. Defrost Heater ON 4. Stepping Motor ON 5. Display fully illuminated
TEST MODE 2	From Test 1 press again TEST S/W	1. COMP & C Fan OFF 2. Freezer fan OFF 3. Defrost Heater OFF 4. Stepping Motor OFF 5. Only F & R not illuminated (first four bars)
NORMAL OPERATION	From Test 2 press again TEST S/W	Compressor will start

* Demonstration MODE:

The OFF icon lights.

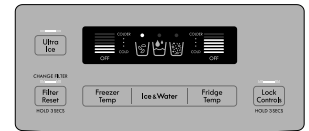

ICE TRAY

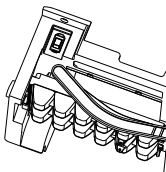

1. ICEMAKER

Test Control → • Press and hold the Test Control button for 3 seconds.
 • It operates in the following modes.

2. CUBE SIZE ADJUSTMENT FUNCTION

CAUTION

Unplug the power cord from the wall outlet and wait 5 minutes before opening the cover, (310 Volts are present in the control panel.)

NOTE: Use chart below to adjust cube size.

Main PCB

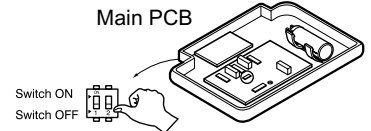

- The water supplying time is set at 7 seconds when the water supply is ON.
- The amount of water supplied depends on the setting of the water supply time.
- If the ice cubes are too small, increase the water supply time.
- If the ice cubes stick together, decrease the water supply time.

CAUTION

To prevent the ice tray for overflowing adjust the cube size.

IMPORTANT DO NOT DESTROY

WIRING DIAGRAMS, SERVICE AND PARTS INFORMATION INCLUDED
REPOSITION TO ORIGINAL LOCATION

REFRIGERATOR COMPARTMENT

