

This Owner's Manual is provided and hosted by [Appliance Factory Parts](#).



KRUPS B95 Owner's Manual

[Shop genuine replacement parts for KRUPS B95](#)



[Find Your KRUPS Small Appliance Parts - Select From 175 Models](#)

----- Manual continues below -----

| | |
|----------------------------------|-----------|
| 1 - Important safeguards | 2 |
| 2 - General Information | 4 |
| 3 - Product description | 5 |
| 4 - Before use | 6 |
| 5 - Using the BeerTender® | 7 |
| 6 - Troubleshooting | 11 |
| 7 - Disposal | 16 |
| 8 - Consumer service | 16 |
| 9 - Limited warranty | 17 |

ENGLISH

KRUPS

1

BeerTender®

1 - IMPORTANT SAFEGUARDS

When using electrical appliances, basic safety precautions should always be followed to reduce the risk of fire, electric shock, and/or injury to persons including the following :

1. Read all instructions.
2. To protect against fire, electric shock and injury to persons, do not place cord, plugs or appliance in water or other liquid.
3. Close supervision is necessary when any appliance is used near children. Keep appliance out of reach of children. Product not intended for use by children.
4. Unplug from outlet when not in use and before cleaning. Allow to cool before putting on or taking off parts, and before cleaning the rest of the appliance.
5. Do not operate any appliance with a damaged cord or plug or after the appliance malfunctions, or has been damaged in any manner. Return appliance to your nearest authorized KRUPS Service Center for examination, repair or adjustment (see Limited Warranty).
6. The use of an accessory not evaluated for use with this appliance by KRUPS may result in fire, electric shock or injury to persons.
7. Do not use outdoors.
8. Do not let cord hang over edge of table or counter, or touch hot surfaces.
9. Do not place on or near a hot gas or electric burner, or in a heated oven.
10. To disconnect, turn the control to «off» then remove plug from wall outlet.
11. Do not use appliance for other than intended use.
12. Appliance for household indoor use only.
13. Do not immerse in water.

SAVE THESE INSTRUCTIONS

KRUPS

2

BeerTender®

CAUTION



This appliance is for household use only. Any servicing other than cleaning and user maintenance should be performed by an authorized service representative.

- To reduce the risk of fire or electric shock, do not remove the base. No user serviceable parts inside. Repair should be done by authorized service personnel only.
- Check voltage to be sure that the voltage indicated on the name plate is compatible with your voltage.
- Never clean with scouring powders or harsh chemicals.
- Never make technical changes or use the appliance in any manner other than as directed.

ENGLISH

SHORT CORD INSTRUCTIONS



A. We do not recommend using an extension cord with this device.

B. If an extension cord is absolutely necessary :

- 1 - the marked electrical rating of the extension cord should be at least as great as the electrical rating of the appliance.
- 2 - To reduce the risk of injury, do not drape cord over the counter top or table top where it can be pulled on by children or tripped over unintentionally.

KRUPS

3

BeerTender®

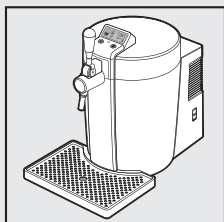

2 - General information

The BeerTender® is designed to dispense chilled beer in a domestic setting. Only a Heineken® 5 Liter DraughtKeg™ and Heineken Premium Light® 5 Liter DraughtKeg™ can be used with the BeerTender. You should not use any other commercially available beer containers or kegs. Do not introduce any materials other than the DraughtKeg inside the appliance.



BeerTender is designed for use by responsible adults of legal drinking age.



Guidelines for reading these instructions

- * The warning triangle indicates instructions that are important for the user's safety.
- * Please adhere strictly to these directions to ensure proper use and avoid serious injury!



- * This symbol highlights information that is especially important for making the best use of the machine.



3 - Product description

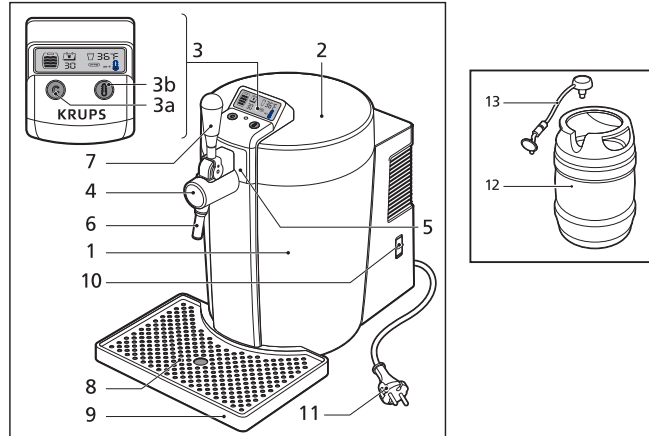

ENGLISH

BeerTender Components

1. BeerTender at home draughting system
2. Lid
3. LCD Control panel
- 3a. Calendar reset button
- 3b. Adjustable temperature control
4. Tap cover
5. Press-in panel to open lid of BeerTender
6. Dispensing pour spout
7. Beer tap handle
8. Drip grate
9. Drip tray
10. Main power switch
11. Power cord with plug

DraughtKeg™ Components

12. 5 Liter DraughtKeg (not included)
13. Replaceable draught beer tube (should be changed with each new DraughtKeg)

KRUPS

5

BeerTender®

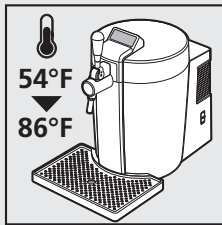
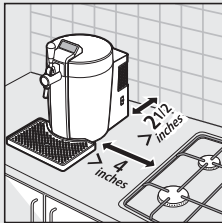
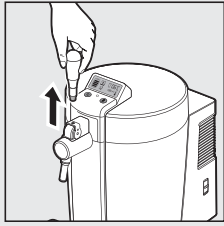

4 - Before use

Child Safety Lock

- * Make sure that children can not play with the appliance.
- * Do not leave the materials used to pack the appliance within children's reach.
- * To prevent children from using the appliance, you can remove the tap handle. To remove the handle, make sure that it is in an upright position and pull upward.

Fire prevention

In the event of a fire, use carbon dioxide (CO₂) extinguishers.

Do not use water or powder extinguishers.

Setup and Maintenance

- * Install the BeerTender® in an upright position in a safe place.
- * To ensure that the BeerTender works correctly and efficiently, the following is strongly advised:
- * Place it on a perfectly level and stable surface.*
Choose a clean, well-lit area with an easily accessible electric socket.
- * Keep the appliance at a minimum distance (4 inches) from the stove as shown in the diagram.
- * Keep the appliance at a minimum distance (2 ½ inches) from the walls.
- * Store the DraughtKeg™ at room temperature or in the refrigerator.
- * Make sure the BeerTender is not exposed to direct sunlight.
- * Do not use the BeerTender outdoors.
- * Do not place the BeerTender on very hot surfaces or near open flames, as these may melt or damage the casing.
- * Your BeerTender uses a technology that delivers ultimate cooling results when the ambient temperature is between 54°F and 86°F. At colder temperatures, the appliance cooling system could be damaged. At warmer temperatures, the cooling system will not be able to reach the temperature you program.

Warning! To avoid overheating, always keep the BeerTender appliance out of direct sunlight. To obtain good cooling performance, never install your machine in a room with an ambient temperature above 86°F.

KRUPS

6

BeerTender®

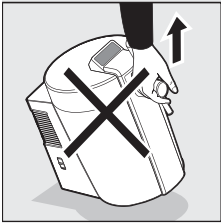

5 - Using the BeerTender® System

- * Always hold the appliance by the bottom edge when lifting.
- * To obtain draught beer of optimal quality you should keep two basic factors in mind, the temperature of the beer and hygienic conditions. Follow these few simple steps for the ideal use of BeerTender®.

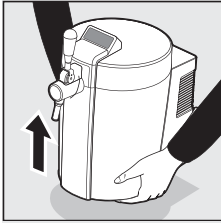

A new draught beer tube should be used with each DraughtKeg™
An initial package of draught beer tube is included with your machine. Additional draught beer tubes can be ordered from Heineken. Go to www.BeerTender.com for more information.

Chilling the DraughtKeg

1. Before pouring a draught beer, it is very important that the Heineken and Heineken Premium Light DraughtKeg reach the correct temperature.
2. Ensure DraughtKeg is sufficiently chilled before pouring a draught beer. DraughtKegs will produce too much foam. It is ideal to purchase the DraughtKeg pre-chilled or pre-chill over night before intended use. If the DraughtKeg needs additional chilling, there are 2 recommended options:
 - a. Inside the BeerTender – Depending on the temperature of the DraughtKeg, it will take up to 18 hours to chill to the ideal serving temperature.
 - b. In a refrigerator – Depending on the temperature of your refrigerator, it will take up to 12 hours to chill to the ideal serving temperature.

Tip: We recommend that you always keep an extra DraughtKeg in your refrigerator to always have a chilled DraughtKeg available.

Preparing the BeerTender

IMPORTANT: It is important that the BeerTender power switch is turned on before inserting the DraughtKeg. This allows the scale to reset and accurately measure the amount of beer left in the keg. If you remove a partially full DraughtKeg from an operating machine or open the lid while power is on, the scale will need to be reset.

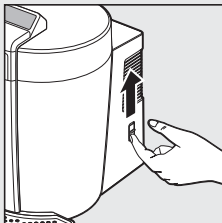

KRUPS

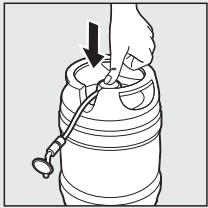
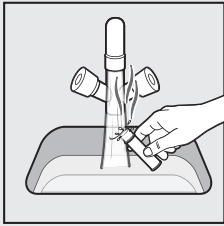

Simply open the lid and lift up the keg for approximately 5-10 seconds before setting back into the machine and closing the lid.

- * After setting up the BeerTender and before use, it is vital to clean the detachable pour spout – this is the only part of the appliance that will come into contact with the beer. The spout should be rinsed by hand. After cleaning, screw back into place.
- * Before inserting the DraughtKeg into the BeerTender, simply snap the patented disposable draught beer tube (included) onto the DraughtKeg.
- * Open the BeerTender cover by pressing in the release panel on the front of the machine.
- * Open the tap spout cover by turning counter clockwise.
- * Insert DraughtKeg into BeerTender and position the draught beer tube as shown on drawing.
- * Close the tap by turning clockwise and snapping into place.
- * Carefully close the lid.
- * Set the drip tray and grate in place at the front of the appliance. Make sure the drip tray is properly fitted and positioned.

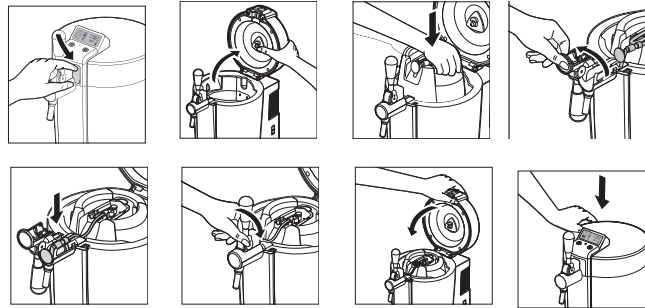

WARNING! The drip tray must be positioned on a level surface and must not jut out from the surface it is resting on.

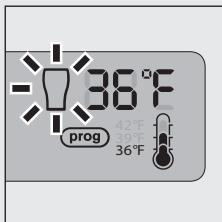

Control Panel

- * Press the “C” button on the lefthand side of the display panel. This resets the 30 day calendar and will countdown from the day you reset with each new Draughtkeg.

KRUPS

8

BeerTender®

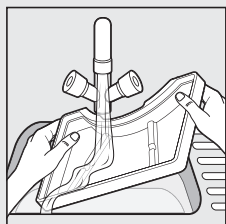
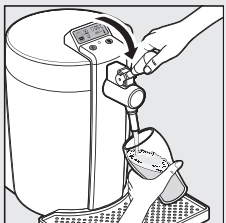
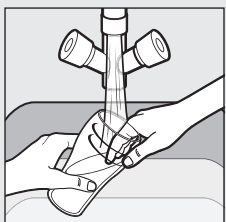
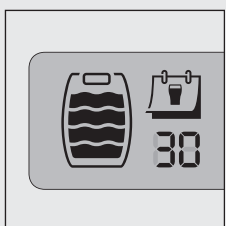
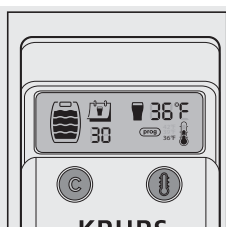

- * Adjust to the desired temperature by pressing the thermometer button on the righthand side of the display panel.
- * The top temperature readout reflects the temperature inside the Draughtkeg.
- * The bottom temperature next to the thermometer image reflects your desired temperature.
- * Wait for your ideal temperature to be reached before pouring a beer.
- * Volume indicator – the barrel on the lefthand side of the display screen reflects the volume left in your DraughtKeg™.
- * There are 4 volume levels – when down to the bottom level, the panel will flash indicating your DraughtKeg is almost empty.
- * Never immerse the appliance in water.

Pouring a beer from the BeerTender

- * Before pouring a beer, rinse clean glass in cold water which chills the glass and wets the inside to enable a perfectly smooth draught pour. Use of 8 oz glasses is recommended to maintain the ideal serving temperature.

Draught and Drink

- * Be aware that the first glass you pour from every new DraughtKeg will contain mostly foam. This is typical of draught beer. Allow the foam to settle and continue to pour.
- * Tilt and pour: Tilt your glass at a 45 degree angle as you pour and adjust upright as the glass fills.
- * Ensure you pull the tap handle all the way down. Not opening the handle all the way will result in excessive foam.
- * For the optimal draught beer drinking experience, serve your beer with a foam head of 2 fingers in height (approximately 1.5").

Proper Care and Cleaning of your BeerTender

- * The drip tray and grate should be emptied and cleaned after each use.
- * Before cleaning the appliance, it is essential to turn off the main power switch and then pull the plug out of the socket.

KRUPS

9

BeerTender®

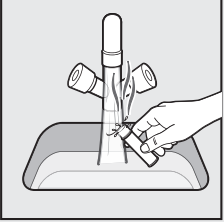
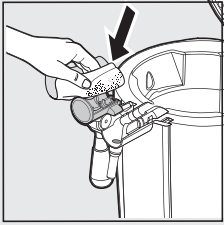

- * Keep in mind that during use the drip tray will have to be emptied and rinsed regularly. The tray and grate are dishwasher safe or can be washed by hand with a mild detergent. Dry completely.
- * Always wipe down the interior of the BeerTender after use. Beer is a natural product that can spoil. Therefore, you should always keep the appliance clean to maintain the quality of the beer dispensed and avoid unpleasant odors.
- * Rinse the pour spout between uses for optimal results. Handwash with warm soapy water. Do not wash in dishwasher.
- * To remove, unscrew turning counterclockwise from main unit. To re-attach, simply screw back in place turning clockwise.
- * You should never attempt to access internal parts of the appliance.



IMPORTANT: After cleaning, ensure all parts of your BeerTender have completely dried before closing the lid.

Storing the BeerTender

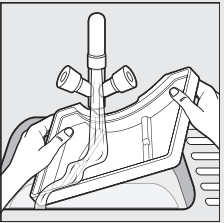

- * When the BeerTender is not being used for a long period of time, remove the DraughtKeg™ and turn the main switch to off.
- * Remove the plug from the power outlet.
- * Store the BeerTender at room temperature in a dry place out of children's reach.
- * Protect from dust and dirt.

KRUPS

6 - TROUBLESHOOTING

| Problem | Possible causes | Solutions |
|---------------------------------|--|---|
| The appliance does not turn on. | The appliance is not connected to the main power supply. | Connect the appliance to the power supply. |
| No beer is being dispensed. | The appliance is off. | Switch the appliance on. |
| | The BeerTender® DraughtKeg is empty. | Replace the BeerTender DraughtKeg with a new one. |
| | There is not a DraughtKeg inside the BeerTender appliance. | Install a DraughtKeg inside the BeerTender appliance. |
| | The BeerTender appliance tap handle is not correctly installed/positioned. | Install/position the tap correctly. |

ENGLISH

KRUPS

11

BeerTender®

ENGLISH

| Problem | Possible causes | Solutions |
|---|---|---|
| The BeerTender produces too much foam when dispensing beer. | The BeerTender DraughtKeg has not reached the right dispensing temperature. | Allow the BeerTender DraughtKeg to cool to the right temperature. |
| | The tap handle is being moved too slowly. | Firmly and quickly pull the handle down and forward as far as it will go. |
| | The BeerTender DraughtKeg has been shaken. | Wait 4 hours before dispensing beer. |
| The Volume Level indicator is blinking. | The Scale needs to be reset with each new DraughtKeg. | Turn the power on before inserting DraughtKeg. If DraughtKeg is inside, open the BeerTender Cover and lift up the DraughtKeg for 3-5 seconds before replacing into machine. |

KRUPS

BeerTender®

| Problem | Possible causes | Solutions |
|---|--|--|
| There is a slight buzz or hum coming from my machine. | This is the normal functioning of the cooling element inside the BeerTender. | |
| Beer flows out too slowly. | The tap handle is not open all the way.(position at 45°). | Open the tap completely. |
| Ice forms in the cooling chamber. | The BeerTender has been installed in a humid environment. | Move the BeerTender to a dry place. |
| | A fault has occurred in the cooling system. | Have the BeerTender repaired by a Krups authorized service center. |
| | It is normal for a small patch of ice to form on the rear the cooling chamber (near the screws). | |

ENGLISH

KRUPS

13

BeerTender®

| Problem | Possible causes | Solutions |
|---|---|--|
| The BeerTender appliance is dispensing warm beer. | The BeerTender DraughtKeg has not been chilled long enough and is not at the right serving temperature. | Allow the BeerTender DraughtKeg to cool in the refrigerator for about 12 hours or inside the BeerTender for up to 18 hours until ideal serving temperature is reached. |
| The lid of the BeerTender does not close. | The tap cover has not been properly closed. | Close the tap cover properly. |
| | The BeerTender DraughtKeg has not been correctly installed. | Install the tap correctly. Ensure the draught tube has been installed completely and is not preventing the lid from closing. |

| Problem | Possible causes | Solutions |
|---|---|--|
| <p>The temperature indicator on the control display never reaches a ready-to-drink level.</p> | <p>The BeerTender® appliance is exposed to a hot temperature or to direct sunlight.</p> | <p>Use the appliance indoors and move to a room where ambient temperature does not exceed 86°F.</p> |
| <p>The control display shows an increasing temperature.</p> | <p>A warm DraughtKeg was installed in a cold appliance.</p> | <p>Allow the BeerTender system to compensate effect of the temperature change. Displayed temperature should start decreasing after 1 hour maximum.</p> |

ENGLISH

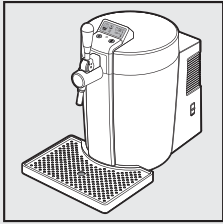

7 - Disposal

* To dispose of your BeerTender®, dispose properly according to your local ordinances for disposing small appliances.

8 - Consumer Service

If you have additional questions, please call our Consumer Service Department. It is helpful to have the product available at the time of your call and to know the reference number that can generally be found on the base of the product.

USA :

Online www.Krupsusa.com

Phone 1-866-232-0788

Hours* Monday – Friday from 8:00 a.m. – 6:30 p.m. (EST)

Letters should be addressed to :

Krups
196 Boston Avenue
Medford, MA 02155

Only letters can be accepted. Packages without a return authorization number will be refused.

*Please note hours are subject to change.

9 - LIMITED WARRANTY

This Krups product is warranted for 1 year from the date of purchase against defects in material and workmanship. During this period, the Krups product that, upon inspection by Krups, is proved defective, will be repaired or replaced, at Krups' option, without charge to the customer. If a replacement product is sent, it will carry the remaining warranty of the original product. This warranty does not apply to any defect arising from a buyer's or user's misuse of the product, negligence, failure to follow Krups' instructions, use on current or voltage other than that stamped on the product, wear and tear, alteration or repair not authorized by Krups, or use for commercial purposes.

THE WARRANTIES SET FORTH HEREIN ARE EXCLUSIVE AND NO OTHER WARRANTIES, EXPRESS OR IMPLIED, INCLUDING BUT NOT LIMITED TO ANY WARRANTY OF MERCHANTABILITY OR FITNESS FOR A PARTICULAR PURPOSE OR USE, ARE MADE BY KRUPS OR ARE AUTHORIZED TO BE MADE WITH RESPECT TO THE PRODUCT.

Some states do not allow limitation on how long an implied warranty lasts or do not allow the exclusion of incidental or consequential damages, so the above limitations may not apply to you.

This warranty gives you specific legal rights, and you may also have other rights, which vary from state to state. If you believe your product is defective, bring the product (or send it, postage prepaid) along with proof of purchase to the nearest authorized Krups Service Center. (To find the nearest authorized Krups Service Center visit the Krups Website or contact the Krups Consumer Service indicated below).

ENGLISH

KRUPS

17

BeerTender®