

This Owner's Manual is provided and hosted by [Appliance Factory Parts](#).



FISHER & PAYKEL VS48 Owner's Manual

[Shop genuine replacement parts for FISHER & PAYKEL
VS48](#)



[Find Your FISHER & PAYKEL HVAC Parts - Select From 16 Models](#)

----- Manual continues below -----



THE PROFESSIONAL AND EURO VENT HOOD

Installation Guide

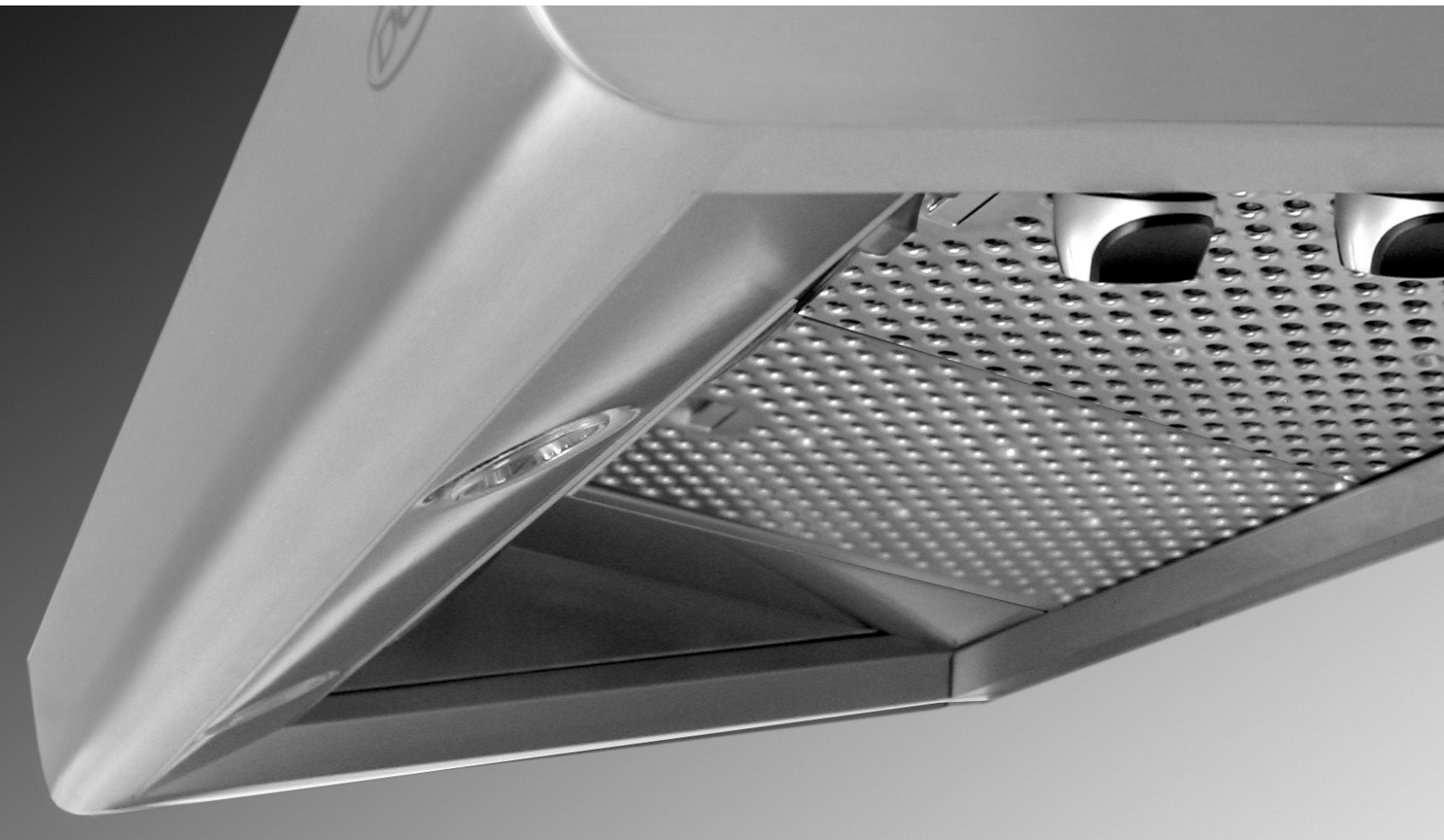

MODELS:

VS30	VS1236
VS36	ES30
VS48	ES36



A MESSAGE TO OUR CUSTOMERS

Thank you for selecting this DCS Professional Vent Hood. Because of this appliance's unique features we have developed this Installation Guide. It contains valuable information on how to properly install your new appliance for years of safe and enjoyable cooking. Keep this guide handy, as it will help answer questions that may arise as you use your new appliance.

For your convenience, product questions can be answered by a DCS Customer Care Representative by phone: 1-888-936-7872, or email: customer.care@fisherpaykel.com.

NOTE: Please write the Model, Code, and Serial Numbers on this page for references (located on the inner back panel, behind grease filters, below motor assembly)

MODEL NUMBER _____ CODE _____ SERIAL NUMBER _____

NOTE: Inspect the product to verify that there is no shipping damage. If any damage is detected, call the shipper and initiate a damage claim. DCS by Fisher & Paykel is not responsible for shipping damage.

DO NOT discard any packing material (box, pallet, straps) until the unit has been inspected.

APPROVED FOR INDOOR COOKING APPLIANCES AND RESIDENTIAL USE ONLY.

**PLEASE READ ENTIRE INSTRUCTIONS BEFORE PROCEEDING.
Installation must comply with all local codes.**



WARNING

If the information in this manual is not followed exactly, a fire or explosion may result causing property damage, personal injury or death.

Do not store or use gasoline or other flammable vapors and liquids in the vicinity of this or any other appliance.



DANGER

If You Smell Gas:

- Do not try to light any appliance.
- Do not touch any electrical switch; do not use any phone in your building.
- Immediately call your gas supplier from a neighbor's phone. Follow the gas supplier's instructions.
- If you cannot reach your gas supplier, call the fire department.
- Installation and service must be performed by a qualified installer, service agency or the gas supplier.

PLEASE RETAIN THIS MANUAL FOR FUTURE REFERENCE.

A MESSAGE TO OUR CUSTOMERS



SAFETY WARNING:

Turn off power circuit at service panel and lock out panel, before wiring this appliance.

Requirement: 120 V AC, 60 Hz. 15 A Branch Circuit



WARNING

To reduce the risk of injury to persons in the event of a rangetop grease fire, observe the following: Turn burner off first. Smother flames with a close-fitting lid, cookie sheet, or metal tray. Be careful to prevent burns. If the flames do not go out immediately evacuate and call the fire department. Never pick up a flaming pan - You may be burned. **DO NOT USE WATER**, including wet dishcloths or towels - a violent steam explosion will result. Use an extinguisher **ONLY** if:

- 1) You know you have a Class ABC extinguisher, and you already know how to operate it.
- 2) The fire is small and contained in the area where it started.
- 3) The fire department is being called.
- 4) You can fight the fire with your back to an exit.

TABLE OF CONTENTS

SAFETY PRACTICES	3-5
PRODUCT DIMENSIONS	6
PARTS	7
BEFORE INSTALLING HOOD	8-9
INSTALLATION	10-15
Wall Mount Installation	10-12
Cabinet Installation.....	13-14
Integral Ventilator Installation.....	15
HOW TO OBTAIN SERVICE	16
WARRANTY	17

SAFETY PRACTICES AND PRECAUTIONS

CAUTION:

For general ventilating use only. **DO NOT** use to exhaust hazardous or explosive materials or vapors.



WARNING:

To reduce the risk of fire, electrical shock, or injury to persons, observe the following :

- A. Use this unit only in the manner intended by the manufacturer. If you have questions, contact the manufacturer.
- B. Before servicing or cleaning the unit, switch power off at service panel and lock service panel disconnecting means to prevent power from being switched on accidentally. When the service disconnecting means cannot be locked, securely fasten a prominent warning device, such as a tag, to the service panel.
- C. Installation work and electrical wiring must be done by qualified person(s) in accordance with all applicable codes & standards, including fire-rated construction.
- D. Sufficient air is needed to maintain proper combustion and safe exhausting of gases through the flue (chimney) of fuel burning equipment to prevent backdrafting. Follow the heating equipment manufacturers guideline and safety standards such as those published by the National Fire Protection Association (NFPA), the American Society for Heating, Refrigeration and Air Conditioning Engineers (ASHRAE), and the local code authorities.
- E. When cutting or drilling into wall or ceiling, do not damage electrical wiring and other hidden utilities.
- F. Ducted systems must always be vented to the outdoors.

CAUTION:

To reduce the risk of fire and to properly exhaust air, be sure to duct air to outside. Do not vent exhaust air into spaces within walls or ceiling, nor into attics, crawl spaces, or garages.



WARNING:

To reduce the risk of fire, use only metal duct work.

Install this hood in accordance with all requirements specified.



WARNING:

To reduce the risk of fire or electric shock, do not use this hood with any external solid state speed control device.

SAFETY PRACTICES & PRECAUTIONS



WARNING:

To reduce the risk of a range top grease fire:

- A. Never leave surface units unattended at high settings. Boilovers cause smoking and greasy spillovers that may ignite. Heat oil slowly on low or medium settings.
- B. Always turn hood "ON" when cooking at high heat or when flambeing food (i.e. Crepes Suzette, Cherries Jubilee, Peppercorn Beef Flambe').
- C. Clean ventilating fans frequently. Grease should not be allowed to accumulate on fan or filter.
- D. Use proper pan size. Always use cookware appropriate for the size of the surface unit.



WARNING:

To reduce the risk of injury to persons, in the event of a range top grease fire, observe the following:

- A. SMOTHER FLAMES with a close-fitting lid, cookie sheet, or other metal tray, then turn off the gas burner or the electric element. BE CAREFUL TO PREVENT BURNS. If the flames do not go out immediately, EVACUATE AND CALL THE FIRE DEPARTMENT.
- B. NEVER PICK UP A FLAMING PAN - you may be burned.
- C. DO NOT USE WATER, including wet dishcloths or towels - a violent steam explosion may result. DO NOT use water on a grease fire. Burning grease and water will explode.
- D. Use an extinguisher ONLY if:
 - 1) You know you have a class ABC extinguisher, and you already know how to operate it.
 - 2) The fire is small and contained in the area where it started.
 - 3) The fire department is being called.
 - 4) You can fight the fire with your back to an exit.

NOTE: Unit MUST be vented to the outside of the building.

IMPORTANT: Refer to ducting information supplied in this Manual (Pg. 9)



WARNING:

To reduce the risk of electrical shock or injury to persons, all vent hoods must be installed with ventilators that have been approved for use with the hood.

SAFETY PRACTICES & PRECAUTIONS

This Vent Hood system is designed to remove smoke, cooking vapors and odors from the cooktop area.

 **WARNING:**

All wall and floor openings where the vent hood is installed must be sealed.

Consult the cooktop or range installation instructions given by the manufacturer before making any cutouts. **MOBILE HOME INSTALLATION-** The installation of this Hood must conform to the Manufactured Home Construction and Safety Standards, Title 24 CFR, Part 3280 (formerly Federal Standard for Mobile Home Construction and Safety, Title 24, HUD, Part 280). Three wire power supply must be used and the appliance wiring must be revised. See electrical requirements on page 1.

- DO NOT use 4" laundry-type wall caps.
- Flexible-type ductwork is not recommended.
- DO NOT obstruct the flow of combustion and ventilation air. Be sure a fresh air supply is available.
- Failure to follow venting requirements may result in a fire.
- Electrical ground is required on this Hood.
- If cold water pipe is interrupted by plastic, non-metallic gaskets or other materials, DO NOT use for grounding.
- DO NOT ground to a gas pipe.
- DO NOT have a fuse in the neutral or grounding circuit. A fuse in the neutral or grounding circuit could result in electrical shock.
- Check with a qualified electrician if you are in doubt as to whether the Hood is properly grounded.
- Failure to follow electrical requirements may result in a fire.
- Be sure all the range and/or cooktop controls are turned off and the appliance is cool before using any type of aerosol cleaner on or around the appliance. The chemical that produces the spraying action could, in the presence of heat, ignite or cause metal parts to corrode.
- Clean the ventilator hood and filters above the range or cooktop frequently so grease from cooking vapors does not accumulate on them.
- Service should only be done by authorized technicians. Technicians must disconnect the power supply before servicing this appliance.

 **WARNING:**

California Proposition 65 - The burning of gas cooking fuel generates some by-products which are known by the State of California to cause cancer or reproductive harm. California law requires businesses to warn customers of potential exposure to such substances. To minimize exposure to these substances, always operate this unit according to the instructions contained in this booklet and provide good ventilation to the room when cooking with gas.

PRODUCT DIMENSIONS

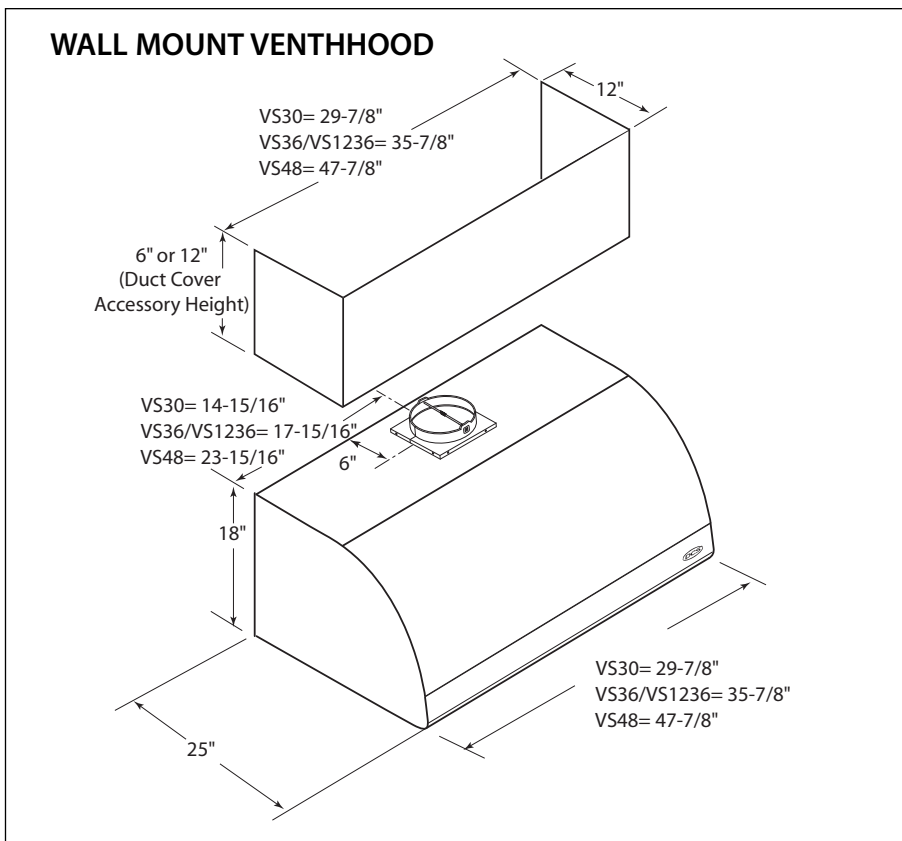
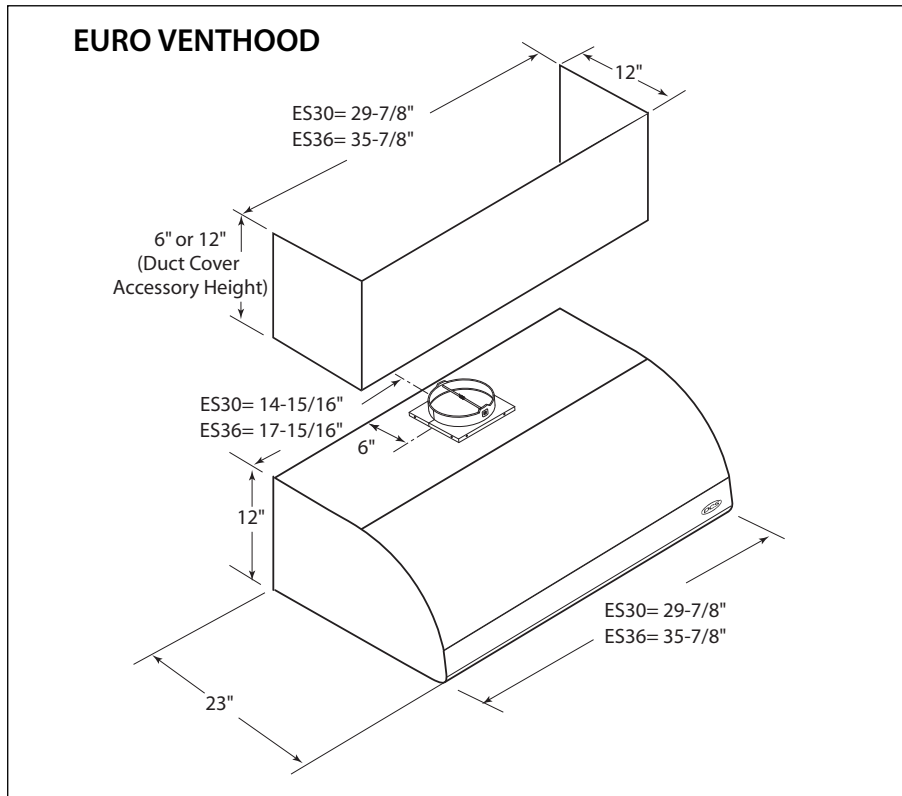

PARTS

PARTS INCLUDED WITH YOUR HOOD

- Hood Canopy Assembly with Light Bulbs installed.
- Metal Transition with Back draft dampers (already installed on ES30, ES36, VS30, VS36 models)
- Use & Care /Installation Instructions
- Filters (quantity depending on model and size)
- Screws and Drywall Anchors
- Wooden Strip for Hood Support
- Drip Trays (quantity depending on model and size)
- Filter Trim Bracket (ES36 model only – Install on unit after electrical connections are completed on page 15)
- Integral Blower

PARTS NOT INCLUDED WITH YOUR HOOD

- Ducting (See Page 9 for duct requirements: 8" or 10" Ø to be used.)
- Duct Tape
- 1/2" Conduit
- Wire Nuts
- Optional duct cover, 6" or 12" height
 - VDC1230 – 12" Duct cover kit for VS30/ES30
 - VDC1236 – 12" Duct cover kit for VS36/VS1236/ES36
 - VDC1248 – 12" Duct cover kit for VS48
 - VDC630 – 6" Duct cover kit for VS30/ES30
 - VDC636 – 6" Duct cover kit for VS36/VS1236/ES36
 - VDC648 – 6" Duct cover kit for VS48
- Optional IR Kit + support bracket (Infrared bulbs included. Use only bulbs mod. 175R-PAR, 175W maximum infrared bulbs).
 - IR30 – Kit with single 175 W heat lamp for VS30/ES30
 - IR36 – Kit with two 175 W heat lamp for VS36/VS1236/ES36
 - IR48 – Kit with two 175 W heat lamp for VS48

BEFORE INSTALLING HOOD

1. For the most efficient air flow exhaust, use a straight run or as few elbows as possible. Maximum duct length is 40 feet, including elbows.

CAUTION:

Vent unit to outside of building only.

2. Two people are necessary for installation.
3. The hood is fitted with Screws and Drywall Anchors suitable for most surfaces. Consult a qualified installer.
4. Do not use flex ducting.
5. COLD WEATHER installations should have an additional backdraft damper installed to minimize the back flow of cold air and nonmetallic thermal break to minimize conduction of outside temperatures as part of the ductwork. The damper should be on the cold air side (outside wall) of the thermal break.

The break should be as close as possible to where the ducting enters the heated portion of the house.

6. Local building codes may require the installation of a make-up air system. Consult your HVAC professional for specific requirements in your area.
7. Hood installation height above cooktop is the users preference. Lower installation heights will improve the efficiency of capturing cooking odors, grease, and smoke. This hood has been approved for installation heights 30" above the cooktop. Taller people may find a 30" installation height is inconvenient. DCS recommends an installation height between 30" and 36".
8. ES30 and ES36 hood models are not recommended to be used over indoor range grills.
9. For installation over DCS Range and Cooktop models RGS-364GL or CS-364GL, the VS1236 model vent is recommended.
10. Make sure your range or cooktop is level.

TYPICAL INSTALLATION

The hood can be installed using a wall mounting system or suspended under existing cabinetry in the kitchen. Ducting can be configured for both vertical and horizontal discharge.

If an infrared kit was purchased for installation with the hood, assemble the kit to the hood prior to installation.

For wall mount installations, duct cover kits can be purchased as spacers between hood and ceiling. Duct covers are assembled to unit after the hood is installed.

BEFORE INSTALLING HOOD

ELELCTRICAL

Install a 1/2" conduit from the service panel long enough to reach the hood once it is installed.

Branch circuit requirement is 120V, 60Hz, 15A(minimum).

INFRARED LAMP AND PANEL KIT

Optional infrared lamp and panel kit can be ordered separately and mounted into your vent hood.

Models available: IR30, IR36 and IR48. See instructions supplied with kit for assembly to your hood.

WARNING

To avoid any electrical shock the installation of the IR lamp should be done by a qualified electrician and before starting the installation of the hood.

DUCTING

Hood models: ES30, ES36, VS30, VS36 are supplied with a starting collar and backdraft damper on top of the hood for connection to 8" round duct. Models: VS1236 and VS48 are supplied with a 10" round transition with damper and is assembled as shown in Fig. 3.

Vertical Discharge Figure

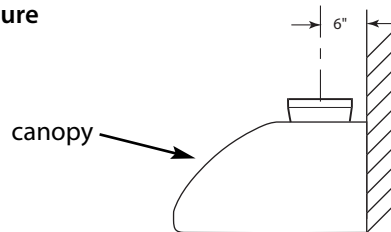
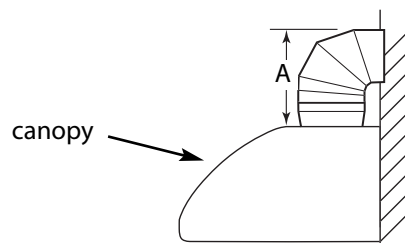

FIG. 1

Horizontal Discharge Figure



FOR 90° ELBOW		A
10"		16"
8"		11"

FIG. 2

Install ducting long enough to reach the transition once the hood is installed plus 1-1/2 inch to connect ductwork.

ASSEMBLE TRANSITION TO HOOD (VS1236 and VS48 hoods only)

The transition supplied with the hood mounts to the top of the hood, Figure 3.

1. Place the transition piece over the hood exhaust and secure with 4 screws provided (Figure 3).
2. Duct tape connection between transition and hood.
3. Remove tape holding damper

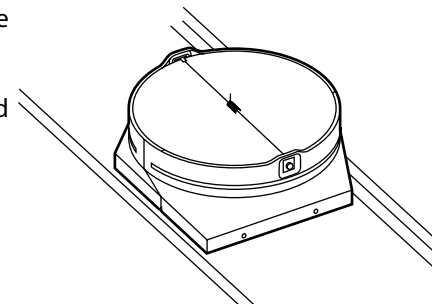
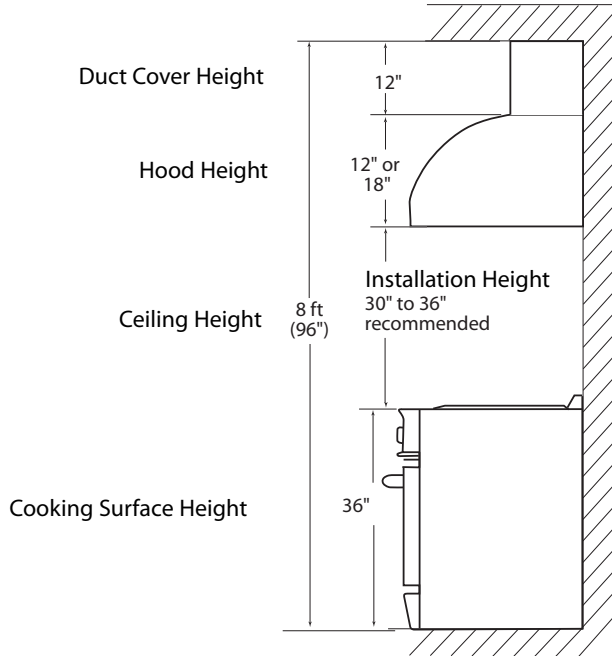

FIG. 3

INSTALLATION

WALL MOUNT INSTALLATION

Calculating Installation Height – Installation height for a standard 8 ft high kitchen ceiling is shown below in Figure X. The minimum installation height allowed is 30". Typical installations are between 30" and 36".



Installation Height Figure X

Use the following formula to calculate installation height:

$$\text{Installation Height} = (\text{Ceiling Height}) - (\text{Height Cooktop Surface}) - (\text{Hood Height}) - (\text{Duct Cover Height})$$

$$(\text{Example: Installation height} = 96" - 36" - 18" - 12" = 30")$$

$$\text{Hood Height} = 12" \text{ for ES30 and ES36 models} \\ 18" \text{ for VS30, VS36, VS1236 and VS48 models}$$

Duct Cover Height – Duct cover accessories are available in 6" or 12" heights. For taller ceilings duct covers can be joined together in any combination.

1. Hood Installation Height

After the hood installation height has been determined, draw a horizontal line at a distance above the cooktop equal to the desired hood installation height plus dimension "E" (see Table on Figure 4).

This line is the mounting location of the wooden bracket shipped with the hood.

2. Find the centerline of the cooktop. Draw a vertical line along this centerline up to the horizontal line drawn in step 1.
3. The hood is mounted to the wall using a wooden bracket shipped with the hood. Remove the bracket from the hood by removing two shipping screws. Mark the centerline of the bracket.

INSTALLATION

4. Find studs behind the drywall by tapping the wall or using a stud finder. Locate one stud on either side of the cooktop centerline to use for mounting the wooden bracket as shown in Figure 4.
5. Align the top of the wood bracket along the horizontal line drawn in step 1. Align the centerlines of the bracket and cooktop.
6. Drill a 3" deep 1/8" hole through the wooden bracket, drywall and into the stud.
7. Use 2 to 4, 1/4" x 3" flat head wood screws to attach the bracket to the wall as shown in Figure 4. For support of longer hoods, use three or four studs as available. Countersink the heads to prevent interference with the hood.
8. On the wood bracket, mark the locations used to hang the hood according to Figure 5 and its Table.

HOOD MODEL	DIM. "E"
VS Series	15-1/2"
ES Series	10-3/8"

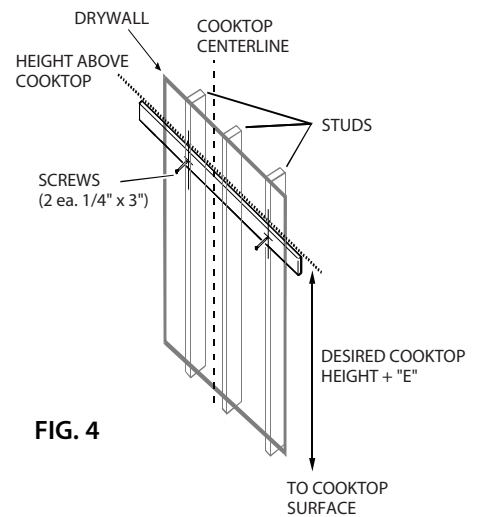

FIG. 4

HOOD MODEL	DIM. "F"
VS Series	7-5/8"
ES Series	7-9/16"

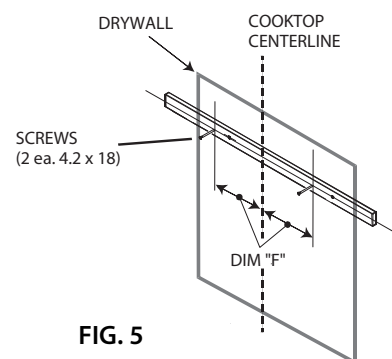

FIG. 5

INSTALLATION

9. Drill a 1/8" hole through the wooden bracket and drywall. These screws do not need to go into the studs.
10. Screw two #10 X 3/4" pan head wood screws into the wood bracket, leaving 1/4" of the screw exposed for hanging the hood.
11. Hang the hood using slots I in Figure 6. Make sure the wood bracket fits into the recess on the back of the hood.
12. Level the hood and tighten screws in slot I.
13. From inside the hood, drive 4 or 6 #10 x 3/4" pan head wood screws (depending on model) through holes J into wooden bracket.
14. Fix duct to transition with screws and seal with duct tape. Screws must not hamper the damper.
15. Drill a 3/8" hole through the center of the holes K into the wall. Insert two wall plugs into drilled holes. Tighten hood to wall anchors by installing 2 screws with washers.

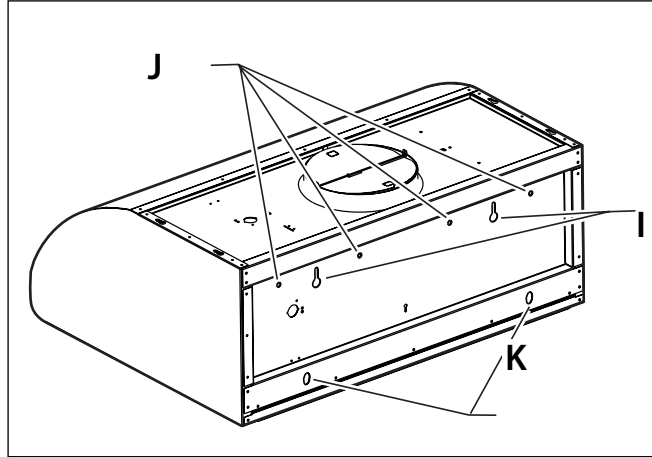

FIG. 6

Go to page 14 to continue the installation.

ASSEMBLY AND INSTALLATION OF THE DUCT COVERS:

Optional duct covers shown in Figure 7 may be used to fill the space between the hood and ceiling in wall mount installations. 6" and 12" high duct covers are available and may be ordered separately.

1. If multiple duct covers are used, connect the pieces together using sheet metal screws provided with chimneys.
2. Attach the duct cover(s) to the hood using sheet metal screws as shown in Figure 7.

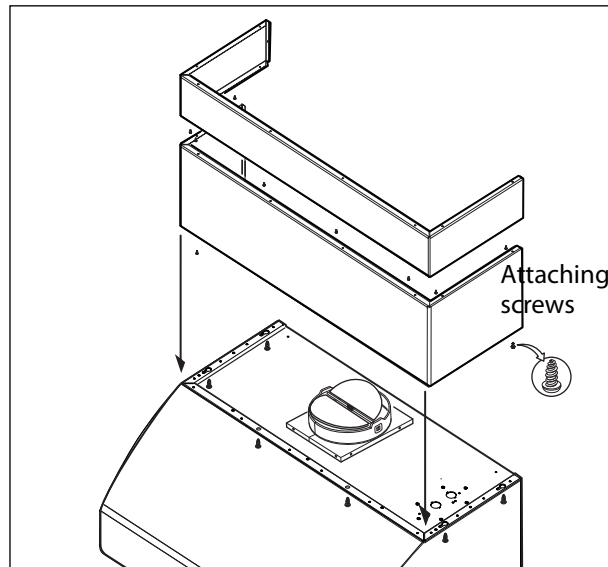

FIG. 7

INSTALLATION

CABINET INSTALLATION

Cabinet Preparation

! WARNING:

The cabinet must be structurally joined to the wall studs to support the weight of this hood.

ES30/ES36 SERIES HOOD

VS30/VS36 SERIES HOOD

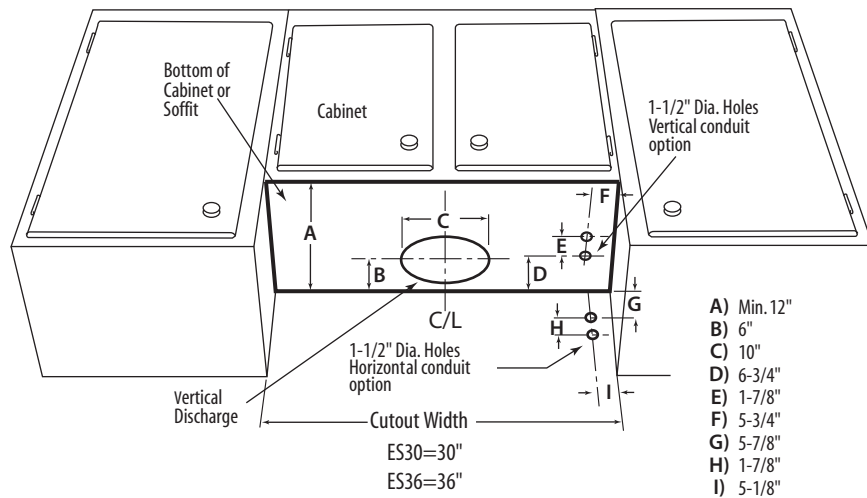

VS1236/VS48 SERIES HOOD

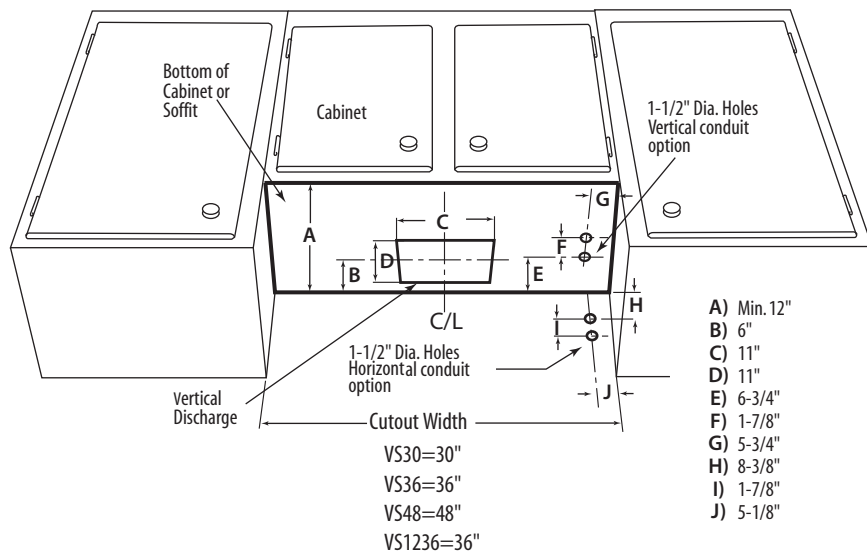

INSTALLATION

CABINET INSTALLATION

1. Find the centerline of the cabinet bottom. Draw a line along this centerline from rear to front of the cabinet.
2. Refer to the top of the hood and Fig. 8. Draw two lines, one at distance 'K' from the wall, the other one at distance 'Z' from the previous line. NOTE: These lines must be perpendicular to the cabinet centerline. Mark 4 points, two along each line at a distance of half W from the center line, to determine the screw locations.
3. Fit four #10 pan head wood screws on cabinet bottom. Do not tighten completely but leave a space of about 1/2" from cabinet bottom surface and screw heads.
4. Hang the hood on screws through side slots provided on hood top. Tighten the four screws.

Drill a 3/8" hole through the center of the holes K into the wall. Insert two wall plugs into drilled holes. Tighten hood to wall anchors by installing 2 screws with washers.

5. Attach duct to transition with screws and seal with duct tape. Screws must not hamper the damper.

ES SERIES

	K	Z	W
ES30	2-11/16"	6-7/8"	29-1/16"
ES36	2-11/16"	6-7/8"	35-1/16"

VS SERIES

	K	Z	W
VS30	2-5/8"	7-1/16"	29-1/16"
VS36/VS1236	2-5/8"	7-1/16"	35-1/16"
VS48	2-5/8"	7-1/16"	47-1/16"

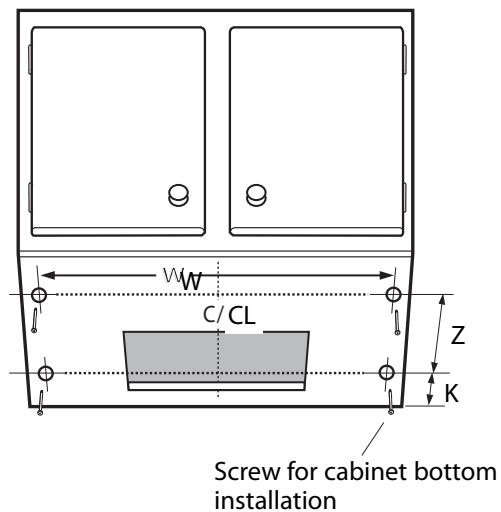
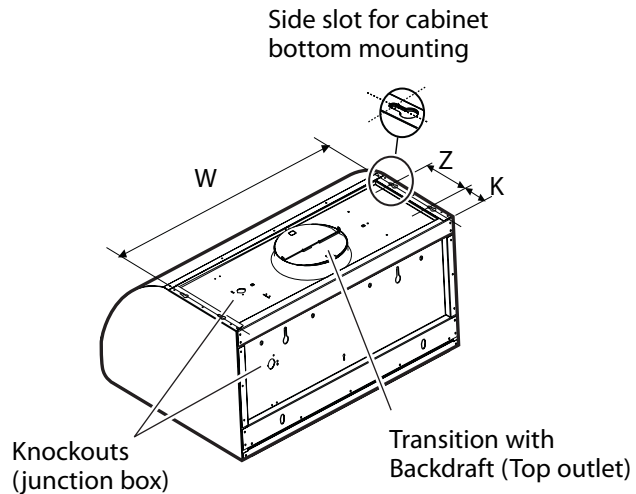

FIG. 8

INSTALLATION

INTEGRAL VENTILATOR INSTALLATION

The Integral ventilator can be mounted to discharge air as shown in Figure 9. From the inside of the hood, slip motor into the bracket on the left. Rotate motor upwards until it snaps into the spring clip on the right.

IMPORTANT: Secure the motor to the hood with the machine screw and lock washer.

WIRING THE HOOD:



WARNING:

Turn off electricity at the service panel before wiring the unit.
Branch circuit requirement is 120V, 60Hz, 15A (minimum).

1. Connect the Integral Ventilator moxex plug connector to the connector present inside the hood as shown in Figure 9 or Figure 10.
2. Remove the j-box cover as shown in Figure 11.
3. Remove 1 of 2 knockouts and install 1/2" conduit connector in j-box.
4. Run black, white, and green wires (#18 AWG) in 1/2" conduit from power supply to j-box.
5. Connect the black to black (hot line) wire, white to white (common line) wire and green/yellow wire to ground in j-box cover.
6. Close j-box cover.
7. For ES36 only: mount the filter trim bracket supplied on the right side of the hood. Check that all engage points perfectly match, then fix with 3 screws as shown in figure 12.

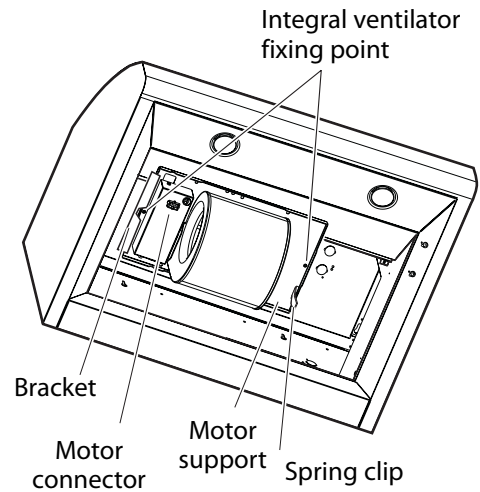

FIG. 9

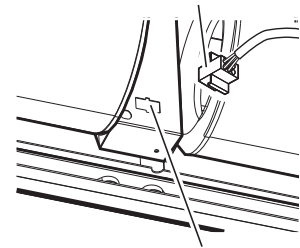

FIG. 10

Final installation steps

Replace filters and grease trays as described in the Use & Care manual. Turn power on at service panel. Check operation of the hood.

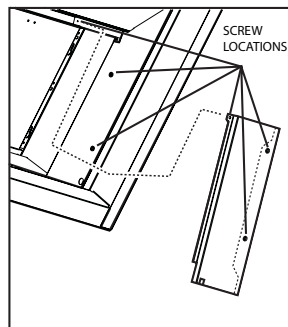

FIG. 12

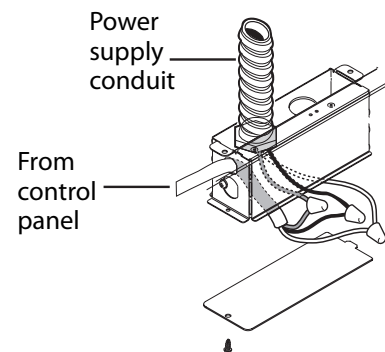

FIG. 11

HOW TO OBTAIN SERVICE

BEFORE YOU CALL FOR SERVICE

- Is the circuit breaker tripped or the fuse blown?
- Is there a power outage in the area?

For warranty service, please contact your local service provider or DCS Customer Care Representative at (888) 936-7872. Before you call, please have the following information ready:

- Model Number (located on the inner back panel, behind grease filters, below motor assembly)
- Serial Number (located on the inner back panel, behind grease filters, below motor assembly)
- Code (located on the inner back panel, behind grease filters, below motor assembly)
- Date of installation
- A brief description of the problem
- Proof of purchase

Your satisfaction is of the utmost importance to us. If a problem cannot be resolved to your satisfaction, please call, write or email us at:

Write:

Fisher & Paykel Appliances, Inc.
Attention: DCS Customer Care
5900 Skylab Road
Huntington Beach, CA 92647

email: customer.care@fisherpaykel.com

WARRANTY

LIMITED WARRANTY

When you purchase a new DCS Ventilation Product for personal or consumer use you automatically receive a One year Limited Warranty covering parts and labor for the entire product, and a Five year Limited Warranty on the switches and motor (parts only) for servicing within the 48 mainland United States, Hawaii, Washington D.C and Canada. In Alaska the Limited Warranty is the same except that you must pay to ship the Product to the service shop or for the service technician's travel to your home. Products for use in Canada must be purchased through the Canadian distribution channel to ensure regulatory compliance.

If the Product is installed in a motor vehicle, boat or similar mobile facility, you receive the same One year Limited Warranty, but you must bring the vehicle, boat or mobile facility containing the Product to the service shop at your expense or pay the service technician's travel to the location of the Product.

FISHER & PAYKEL UNDERTAKES TO:

Repair without cost to the owner either for material or labor any part of the Product, the serial number of which appears on the Product, which is found to be defective. In Alaska, you must pay to ship the Product to the service shop or for the service technician's travel to your home. If the Product is installed in a motor vehicle, boat or similar mobile facility, you must bring it to the service shop at your expense or pay for the service technician's travel to the location of the Product. If we are unable to repair a defective part of the Product after a reasonable number of attempts, at our option we may replace the part or the Product, or we may provide you a full refund of the purchase price of the Product (not including installation or other charges).

This warranty extends to the original purchaser and any succeeding owner of the Product for products purchased for ordinary single-family home use. All service under this Limited Warranty shall be provided by Fisher & Paykel or its Authorized DCS Service Agent during normal business hours.

HOW LONG DOES THIS LIMITED WARRANTY LAST?

Our liability under this Limited Warranty for the entire product expires One Year from the date of purchase of the Product by the first consumer. Our liability under this Limited Warranty for the switches and motor (parts only) expires Five Years from the date of purchase of the Product by the first consumer.

Our liability under any implied warranties, including the implied warranty of merchantability (an unwritten warranty that the Product is fit for ordinary use) also expires One Year (or such longer period as required by applicable law) from the date of purchase of the Product by the first consumer. Some states do not allow limitations on how long an implied warranty lasts, so this limit on implied warranties may not apply to you.

THIS WARRANTY DOES NOT COVER:

- A. Service calls that are not related to any defect in the Product. The cost of a service call will be charged if the problem is not found to be a defect of the Product. For example:
1. Correct faulty installation of the Product.
 2. Instruct you how to use the Product.
 3. Replace house fuses, reset circuit breakers, correct house wiring or plumbing, or replace light bulbs.
 4. Correct fault(s) caused by the user.
 5. Change the set-up of the Product.
 6. Unauthorized modifications of the Product.

WARRANTY

7. Noise or vibration that is considered normal, for example, drain/fan sounds, regeneration noises or user warning beeps.

8. Correcting damage caused by pests, for example, rats, cockroaches etc.

B. Defects caused by factors other than:

1. Normal domestic use or

2. Use in accordance with the Product's Use and Care Guide.

C. Defects to the Product caused by accident, neglect, misuse, fire, flood or Act of God.

D. The cost of repairs carried out by non-authorized repairers or the cost of correcting such unauthorized repairs.

E. Travel Fees and associated charges incurred when the product is installed in a location with limited or restricted access. (i.e. airplane flights, ferry charges, isolated geographic areas).

F. Normal recommended maintenance as set forth in the Product's Use and Care Guide.

If you have an installation problem contact your dealer or installer. You are responsible for providing adequate electrical, exhausting and other connection facilities. We are not responsible for consequential or incidental damages (the cost of repairing or replacing other property damaged if the Product is defective or any of your expenses caused if the Product is defective). Some states do not allow the exclusion or limitation of incidental or consequential damages, so the above limitation or exclusion may not apply to you.

HOW TO GET SERVICE

Please read your Use and Care Guide. If you then have any questions about operating the Product, need the name of your local DCS Authorized Service Agent, or believe the Product is defective and wish service under this Limited Warranty, please contact your dealer or call us at:

TOLL FREE 1-888-936-7872 or contact us through our web site: www.dcsappliances.com.

You may be required to provide reasonable proof of the date of purchase of the Product before the Product will be serviced under this Limited Warranty.

COMMERCIAL USE

This warranty applies to appliances used in residential applications; it does not cover their use in commercial situations.

NO OTHER WARRANTIES

This Limited Warranty is the complete and exclusive agreement between you and Fisher & Paykel Appliances, Inc. regarding any defect in the Product. None of our employees (or our Authorized Service Agents) are authorised to make any addition or modification to this Limited Warranty.

Warrantor: Fisher & Paykel Appliances, Inc.

If you need further help concerning this Limited Warranty, please call us at the above number, or write to:

Fisher & Paykel Appliances, Inc.
5900 Skylab Road, Huntington Beach, CA 92647

This Limited Warranty gives you specific legal rights, and you may also have other rights which vary from state to state.



Quality provided by Fisher & Paykel Appliances Inc.

Fisher & Paykel Appliances, Inc.
5900 Skylab Road, Huntington Beach, CA 92647
Customer Care: 888.936.7872
Fax: 714.372.7003
www.dcsappliances.com

As product improvement is an ongoing process, we reserve the right to change specifications or design without notice.

Nous améliorons constamment ses produits et se réserve le droit de modifier les spécifications ou la conception de ses produits sans aucun préavis.

P/N 221709 Rev. D
Litho in USA 08/2008