

This Owner's Manual is provided and hosted by [Appliance Factory Parts](#).



# Wolf CTEWH451 Owner's Manual

[Shop genuine replacement parts for Wolf CTEWH451](#)



[Find Your Wolf HVAC Parts - Select From 108 Models](#)

----- Manual continues below -----



## Cooktop Low-Profile Wall Hoods

Behind the contemporary lines of the Wolf cooktop low-profile hoods, there's a lot of hard-nosed functional thinking. Brilliant halogen lighting illuminates your cooking surface. Powerful multi-speed blowers whisk away smoke and odors. Available in three widths, low-profile wall hoods are stainless steel with a black glass front panel and are recommended for use with Wolf induction, electric and gas cooktops and integrated modules.



Model CTEWH30I shown.

### FEATURES

- Heavy-duty stainless steel construction.
- Telescopic flue fits 8' to 9' ceilings.
- Front-mounted electronic controls with digital indicator and four-speed blower control.
- Sealed halogen lighting with three settings.
- Internal, in-line and remote blower options.
- Internal blower (I) models can be used in a non-ducted application using an accessory charcoal recirculating filter.
- Heat sentry feature automatically turns unit on when heat is sensed and automatically adjusts blower speed.
- Delay-off mode automatically turns unit off.
- Stainless steel filter cover with dishwasher-safe aluminum mesh filter.
- Filter clean indicator lets you know when the filter needs cleaning.
- Transition with backdraft damper included.

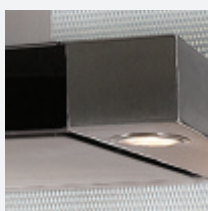

Sealed halogen lighting.



Electronic controls.

### MODEL OPTIONS

Model	CTEWH30I	CTEWH36	CTEWH36I	CTEWH45	CTEWH45I
Overall Width	30"	36"	36"	45"	45"
500 CFM Internal Blower Included	•		•		•

### BLOWER OPTIONS

	INTERNAL				IN-LINE		REMOTE			
CFM	500	600	900	1200	600	1100	600	900	1200	1500
CTEWH36 CTEWH45					•		•			

### ACCESSORIES

- In-line and remote blowers for CTEWH36 and CTEWH45 (refer to chart above).
- 30" high stainless steel wall shield in 30" and 36" widths (not available in 45" width).
- Recirculating kit for non-ducted installations.
- Replacement charcoal filters.

Accessories are available through your authorized Wolf dealer. For local dealer information, visit the find a showroom section of our website, [wolfappliance.com](http://wolfappliance.com).



Model CTEWH36  
Cooktop Low-Profile Wall Hood



## Cooktop Low-Profile Wall Hoods

### OVERALL DIMENSIONS

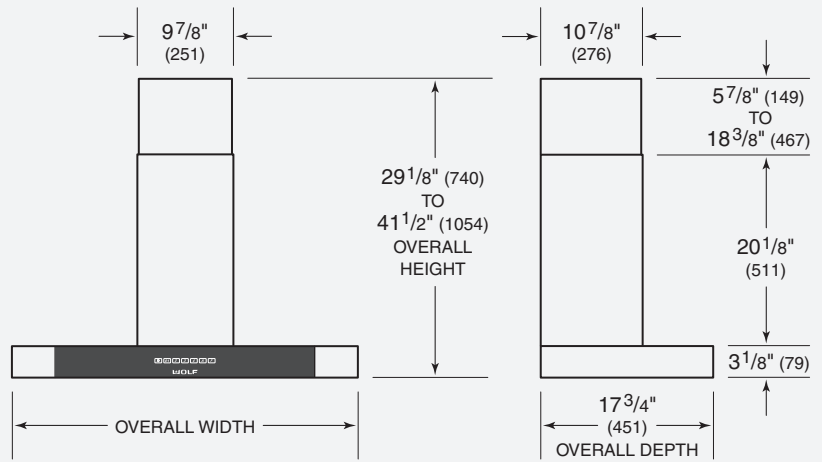

Unit dimensions may vary by  $\pm 1/8$ ".

### SPECIFICATIONS

Exterior Finish	Stainless Steel
Overall Widths	30", 36" and 45"
Height (excluding chimney)	3 1/8"
Min Height (including chimney)	29 1/8"
Max Height (full extension)	41 1/2"
Overall Depth	17 3/4"
Bottom of Hood to Countertop	24" to 30"
Discharge	Vertical
Duct Size	6" Round
Electrical Requirements	110/120 V AC 60 Hz, 15 amp dedicated circuit
Shipping Weight	53–62 lbs

### INSTALLATION SPECIFICATIONS

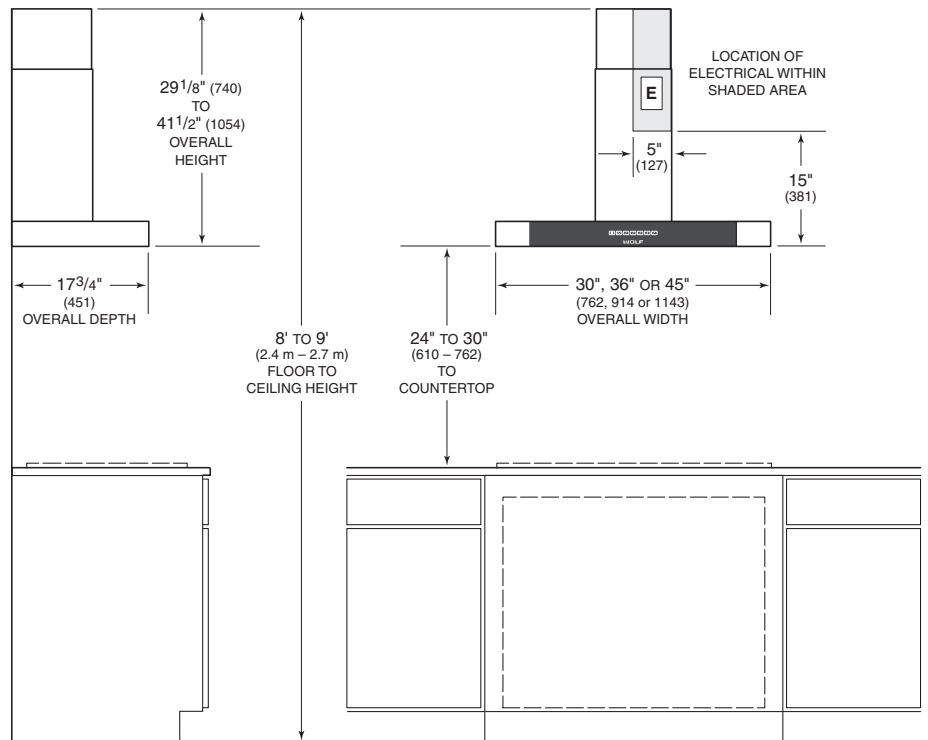

### INSTALLATION NOTES

(I) models include a 500 CFM internal blower. An in-line or remote blower is required for models CTEWH36 and CTEWH45. For blower recommendations, visit our website, [wolfappliance.com](http://wolfappliance.com).

Cooktop low-profile hoods are recommended for use with Wolf induction, electric and gas cooktops and integrated modules. For Wolf ranges and rangetops, a pro ventilation hood is recommended.

Complete installation specifications can be found on our website, [wolfappliance.com](http://wolfappliance.com).

Dimensions in parentheses are in millimeters unless otherwise specified.