

This Owner's Manual is provided and hosted by [Appliance Factory Parts](#).



# TWIN EAGLES TEBQ30R-B Owner's Manual

[Shop genuine replacement parts for TWIN EAGLES  
TEBQ30R-B](#)



[Find Your TWIN EAGLES Grill Parts - Select From 58 Models](#)

----- Manual continues below -----



DEFINING  
THE ART  
*of*  
OUTDOOR  
COOKING





## LED Lights & Polished Edges

Blue decorative lights illuminate the control knobs turning your grill into the main attraction, even when not in use. The exquisite hi-polished accents add luxurious refinements to your grill and accessories.



# TWIN EAGLES *Style*

Stylish outdoor kitchens are the latest trend in outdoor entertaining. Choosing the right grill and accessories for your perfect backyard entertainment center is important. It's your personal touch to your outdoor kitchen, a reflection of your lifestyle.

Twin Eagles design is truly unique, with exclusive geometric shapes, contoured angles, seamless welds and hi-polished accents. Every grill is an intriguing blend of modern design and classic elegance, making them a perfect match for both traditional and contemporary architecture.





## Zone Dividers

Each burner is individually contained to control heat independently from one area to another. You will be able to maintain each zone with a different temperature or effectively cook with only one burner operating.



# TWIN EAGLES *Performance*

The unrivaled Twin Eagles Cooking System, developed by award-winning Gas Engineer Dante Cantal, is what separates Twin Eagles from all other grills.

Every detail of the grill promotes this extraordinary Cooking System. Mixing direct heat from specifically placed ports and channels with radiant heat from ceramic briquettes allows your grill to reach higher temperatures and distribute heat evenly to the grates. Your grill will preheat faster, perform better and use less gas.

Hexagonal grates retain and conduct more heat into your food and provide more food to surface contact to brand your food with thick restaurant style sear marks.

Drafting vents draw cool air from the bottom of the firebox keeping the heat above the burners where it is needed while keeping the air/gas mixture constant for a more efficient flame. Zone dividers enable you to grill effectively with one burner only or regulate each area at a different temperature when cooking different food items.

This highly engineered Cooking System will elevate your next outdoor grilling experience to new levels of performance.





## Hand Crafted

Each Twin Eagles grill and accessory is individually hand crafted with pride and incredible attention to details, ensuring that every product has the proper fit and finish.



# TWIN EAGLES *Quality*

Quality you will immediately see, feel and trust. The latest laser cutting technology allows Twin Eagles to create the precise geometric shapes unique to its signature styling. The use of high grade 300 Series stainless steel and seamless heli-arc welded construction provides tremendous strength and durability essential for outdoor use.

Quality Control is assured throughout every step of the manufacturing process resulting in superior craftsmanship that will withstand and endure the harsh elements of the outdoors and bring you and your family timeless enjoyment.

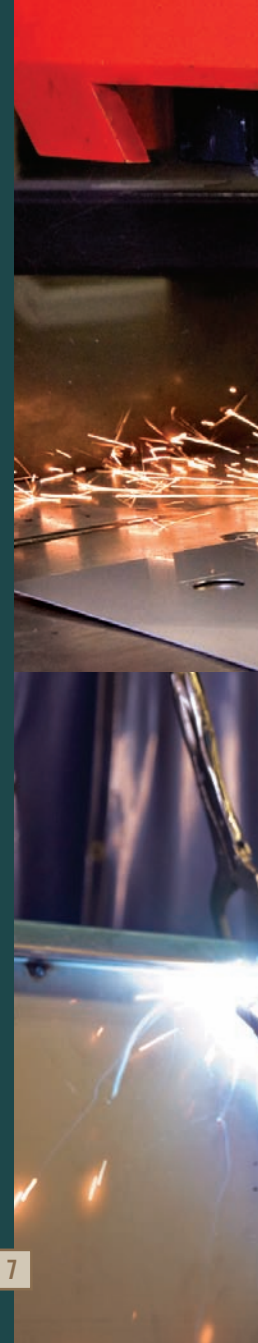



BUILT-IN PREMIUM



### Sear Zone

All 30", 36" and 42" grills are available with or without Sear Zone. 25,000 BTUs of Direct Heat will sear your meats faster and deeper to seal in more juices. More juices means moist, more flavorful food.



#### TEBQ30G-B

#### 30" Gas Grill

- TEBQ30GS-B
- TEBQ30R-B
- TEBQ30RS-B

- 30" Gas Grill with Sear Zone
- 30" Gas Grill with Infrared Rotisserie
- 30" Gas Grill with Infrared Rotisserie & Sear Zone

#### TEBQ36R-B

- TEBQ36G-B
- TEBQ36GS-B
- TEBQ36RS-B



### **TEBQ42R-B**

### **42" Gas Grill** with Infrared Rotisserie

TEBQ42G-B  
TEBQ42GS-B  
TEBQ42RS-B

42" Gas Grill  
42" Gas Grill with Sear Zone  
42" Gas Grill with Infrared Rotisserie & Sear Zone

### **Features**

- 14 gauge 304 stainless steel burners with lifetime warranty
- High quality ceramic briquettes
- Hexagonal grates for more surface to food contact
- Zone dividers to regulate different temperatures
- Reliable hot surface ignition
- Easy to open hood assist system
- Interior lights with hood activated light switch for nighttime grilling
- Decorative LED control panel lights
- Multi-position and stow away warming rack
- Large capacity smoker box

### **Optional Features**

- Double position infrared rotisserie
- Variable heat level infrared sear zone



# Salamangrill

10



## Salamangrill TESG24

Upgrade your outdoor design of our patented infrared burner module generates 1700 degrees in 90 seconds. This unique flavor without flare

- Four (4) level positions
  - Pizza in 4 minutes
  - 1 1/2" thick steaks
  - Fish in 6 minutes
  - Chicken in 6 minutes
- 15,000 BTU infrared burner
- Cooking grate rotates
- 13" Pizza stone included
- Patented technology

## BUILT-IN ACCESSORIES



### Infrared Sear Station

TESS13-B

Sear steaks to lock in juices just like the best steakhouses with our Infrared Searing Station. Also great for searing Ahi tuna.

- 24,000 BTU gas infrared burner
- Battery powered electronic ignition
- Drip tray for easy cleaning
- Optional griddle plate attachment
- Stainless steel cover included
- LED control panel light  
(must be connected to the grill)



### Side Burners

TESB131-B / TESB132-B

Side Burners add tremendous versatility to your outdoor kitchen. Whether you need to boil, stir fry, saute or simmer, the 17,500 BTU dual ring European sealed burner(s) is ready to deliver the heat you need. The one piece stainless steel "S" grate allows for easy maneuverability of pots and pans between burners.

- Available with single burner (TESB131) or double burner (TESB132)
- Wind guard
- Stainless steel cover included
- LED control panel lights



### Dine & Breakfast Club

TEBC30-B

A great companion to your grill, our innovative Dine & Breakfast Club is perfect for family breakfast outside, or complement your evening barbecue with grilled shrimp, scallops, chicken or sauteed vegetables.

#### Griddle:

- Stainless steel, solid cooking griddle surface
- Thermostat control with heat on indicator light
- Electric hot surface ignition with safety gas valve
- 20,000 BTU stainless steel griddle burner
- 120 V electrical power cord supplied

#### Side Burner:

- Stainless steel, "S" grates to easily slide pots and pans
- Two (2) 17,500 BTU dual ring European sealed burners
- Battery powered electronic ignition
- Stainless steel cover included
- LED control panel lights

Outdoor kitchen griddles — a pioneering innovation from Two

### Teppan

TEPG30-B

Our u... comp... of day... grilled... of bor... And c...

- Stai...
- Two...
- cont...
- Total...
- Heat...
- Hot...
- 120...
- Stai...
- LED...

# Warming



## Grill Hood Assist System

Concealed heavy duty extension springs allow for easy opening and closing of the hood by reducing the weight load.



## 42" Warming Drawer Combo

TEWD42C-B

You get all the great features of our versatile warming drawer plus the benefit of additional storage. This deluxe combination includes a warming drawer with a practical oversized storage drawer and slide out trash holder (or LP tank holder).

- 2.1 cu. ft. storage drawer
- Two (2) steam pans that are specifically designed for steam or dry warming
- Heat fluctuation from 60° to 220° F (15° to 104° C)
- Concealed thermostat control
- 120 V electrical cord included



## 30" Warming Drawer

TEWD30-B

Keep food warm in this warming drawer. Ideal for keeping bread warm to eat. Humidifier drawer, keeping food moist. Can also be used for warming.

- Two (2) steam pans for steam or dry warming
- Concealed thermostat control
- Heat fluctuation from 60° to 220° F (15° to 104° C)
- 120 V electrical cord included
- Approved for use in commercial kitchens

# ACCESS DOORS & STORAGE DRAWERS

## Access Doors Features:

- Soft closing, three way adjustable concealed door hinges
- Double walled doors with welded inside liners
- Detailed finish welded corners
- One-piece mounting frame for precision alignment
- Flush handle design with hi-polished accents

## Storage Drawers Features:

- Self latching, and 100 lbs. capacity, full extension slides.
- Extra deep drawers for oversized utensils
- Superior welding and finish
- One-piece front frame for precision alignment
- Flush handle design with hi-polished accents



**30" Wide Large Capacity Drawer**  
TESD301-B



**Two Storage Drawers**  
TESD133-B



**Three Storage Drawers**  
TESD132-B

**30" Cooler Draw**  
TECD30-B

- 48 quart ice chest
- One-piece mounting
- Flush handle design



**TEDD302-B**

**Door/Two Drawer Combos**

- TEDD302-B
- TEDD362-B

- 30" Wide Door & 2 Drawer Combo (shown)
- 36" Wide Door & 2 Drawer Combo

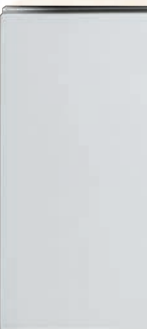

**TEAD30-B**

- TEAD18-B
- TEAD30-B
- TEAD36-B
- TEAD42-B



### 30" Outdoor Bar TEOB30-B

What backyard sanctuary is complete without an outdoor bar? Our 30" bar includes an insulated ice compartment that holds up to 40 lbs of ice. Three specially designed compartments keep beverages cool and condiments fresh.

- Stainless steel sliding ice bin cover
- Front speed rail holds 1-liter bottles
- Stainless steel bottle opener and towel ring
- Stainless steel bar sink and chrome faucet

## BUILT-IN BAR ACCESSORIES



### 18" Outdoor Bar TEOB18-B

Great beverage center for outdoor entertaining. Includes an insulated ice compartment that holds up to 40 lbs of ice. Three specially designed compartments keep beverages cool and condiments fresh.

- Stainless steel sliding ice bin cover
- Front speed rail holds 1-liter bottles
- Stainless steel bottle opener and towel ring



### Outdoor Refrigerator TEOR24-B

Keep beverages, marinating meats and side dishes cold with the convenience of a refrigerator in your outdoor kitchen. With 6.1 feet of storage, two removable tempered glass shelves and three door mounted shelves, this refrigerator can accommodate a variety of items.

- UL Listed suitable for outdoor use
- Stainless steel exterior sides, top and full wrap door
- Automatic interior light
- Full auto defrost
- Adjustable temperature range from 33 to 52 degrees F

### Beer Keg TEBK24-B

Serve up from the tap! It c and include and regulat

- Indoor and
- Adjustable to 52°F fo



### Hot Surface Ignition

Lighting the gas burners and the rear rotisserie burner just got easier with electric hot surface glow plug ignitors. The more reliable ignitors operate by pushing in the burner or rotisserie control knob.

16

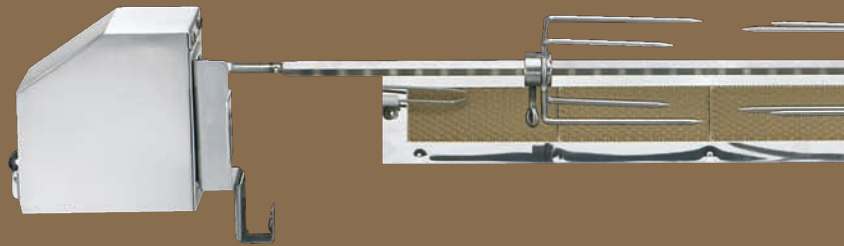

30", 36" and 42" grills are available with an infrared rear rotisserie burner and rod, meat forks, and porcelain basting pan. Two position system maintains pressure on the rear burner to control efficient browning and to contain more juices. Rotisserie motor

## ACCESSORIES



### Trash Chute

TETC

Impressive low profile trash chute aligns over the built in trash drawer (TETD18T-B) to easily dispose of bottles, trash and discard waste. Includes a sliding cutting board for food prep and a stainless steel cover which fits over the cutting board and chute to conceal when not in use.

- Removable sliding cutting board
- Convenient angled side wall directs waste toward trash container below
- Stainless steel cover included
- Trash Drawer (TETD18T-B) sold separately



### Tall Trash Drawer (18"W x 26"H)

TETD18T-B

- Holds larger capacity trash container (container included)
- Full pull out drawer for better stability
- Flush hi-polished handle
- Trash Chute (TETC) sold separately

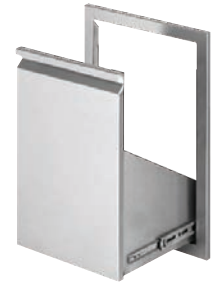

### Trash Drawer (18"W x 20.75"H)

TETD18-B

- Adjustable brackets to fit all standard size trash containers and LP tanks (container not included)
- Flush handle design with hi-polished accents



### Paper Towel Holder

TEPT15-B

- Holds standard size paper towel
- Swing down paper towel compartment
- Flush handle design with hi-polished accents



### Paper Towel Drawer

TEPT15SD-B

- Holds standard size paper towel
- Slide out paper towel drawer
- Storage tray
- Towel Bar



### Smoker Box

Enhance the flavor of your food. Sealed Smoker Box holds liquid for soaking hickory, mesquite, or your favorite woodchips to give meat smokey flavor.



## Griddle Plate

**Griddle Plate**  
TEGP12

Convenient griddle surface for use on our grills and side burners. Great for grilling breakfast, fajitas, or stir fry. All stainless steel construction.

# Ventilation



## Twin Eagles Ventilation Hood

TEVH36-B / TEVH48-B

High performance ventilation hoods draw heat, steam and grease away from your cooking area. Seamless design with hi-polished accents complement the design of our grills and accessories. Available in 36" and 48" sizes.

- Seamless welded with hi-polished accents
- Engineered and approved for outdoor/indoor use when installed under protective roof
- Easy to remove, dishwasher safe stainless steel baffle filters
- 3-speed ventilator control
- 2 halogen lamps with dual settings
- Internal and remote motors sold separately



## Tool Holders

Both side shelves have specially designed tool holders to keep your tools handy, yet conveniently out of the way, so your side shelves may be used for other items essential to grilling.





## FREESTANDING PREMIUM GRILLS

Twin Eagles 30", 36" and 42" grills are available with integrated grill bases for a portable freestanding grill option. The grill bases beautifully match grills and accessories. Standard features include soft closing doors and self latching drawers, heavy duty casters with front brakes for easy maneuverability and locking, and fold down side shelves with tool holders. The pull-out tray inside can be used to hold a trash receptacle or LP tank. Access doors and storage drawers feature flush handle design with hi-polished accents.



**TEGB42SD-B** 42" Gas Grill Base with Storage Drawers



**TEGB36SD-B** 36" G



**TEGB30SD-B** 30" G



### Hexagonal Grates

Our grills feature 3/8" stainless steel hexagonal grates which retain more heat, enabling more heat contact to food for even cooking. Plus, these grates generate dark, deep, professional restaurant-style sear marks.



**TEGB36-B**

**36" Gas Grill Base** with 2 Doors



**TEGB30-B**



### Twin Eagles Vinyl Cover

**VCBQ36F-B** (shown)

Protect your investment with an all-weather fine stainless steel finish while the durable vinyl cover protects your grill from the weather. Available on all 30", 36" and 42" models.

## FREESTANDING GRILL ACCESSORIES



### Cart Mounted Side Burners

TESB132F-B

- Easily attach to all Twin Eagles Grill Bases
- 17,500 BTU dual ring European sealed burners allows for greater heat distribution
- One piece stainless steel "S" grate for easy maneuverability of pots and pans
- Available with single burner TESB131F-B or double burner TESB132F-B (shown)
- Wind guard
- Stainless steel cover included



### Salamangrill Base

TSGB24

- Four (4) heavy duty swivel casters with brakes
- Side shelf with tool holders
- Push handle bar for easy movement
- Storage drawer with 100 lb capacity
- Stainless steel towel ring
- Accommodates a 20 lb LP tank



TEBC30-B (shown)  
or TETG30

TEGB30-B (shown)  
or TEGB30SD

### Freestanding Dine & Breakfast Club or Teppanyaki Griddle

The Dine & Breakfast Club and Teppanyaki Griddle are both available as freestanding units by integrating either 30" Outdoor Gas Grill base (TEGB30-B or TEGB30SD-B) for a unique portable option which beautifully matches your grill and accessories. Match either product with the grill base of your choice to create the custom solution that works best in your outdoor kitchen. Features include heavy duty casters with front brakes for easy maneuverability and locking, and fold down side shelves with tool holders. The soft closing doors and self latching drawers feature flush handle design with hi-polished accents.



# Heaters

## GAS HEATER

8"

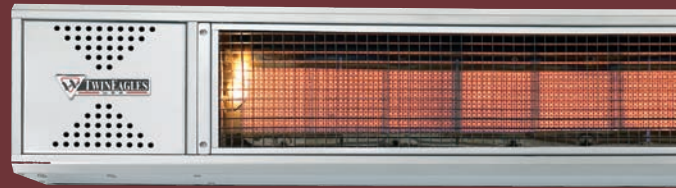

### 48" Outdoor Gas Infrared Heater

TEGH48

Our Radiant Gas Heater is the ultimate heat source to extend your outdoor living space, providing comfortable heat year round. Our 48" Infrared Heater will keep you warm and comfortable, while easily controlling the heat settings from a convenient wall-mounted remote control.

- Two heat levels: Low setting at 25,000 BTU and high setting at 37,000 BTU
- Wireless remote control (No electrical wiring required)
- Spark ignition with 100% safety pilot
- Decorative safety grill that provides shielding from wind. Wind proof up to 15 MPH
- Complete with mounting brackets and gas hose



Wall mounted wireless remote control (included)



Flexible gas hose approved for NG & LP (included)



120 VAC / 6 VDC Adapter (optional)



A set of stainless steel mounting brackets (included)

HE  
Heat



Ft. 1

# ELECTRIC HEATERS



## 39" Electric Radiant Heater (Indoor/Outdoor)

TEEH2524

Length: 39"      Volts: 240  
Watts: 2500      Amps: 10.4



## 61" Electric Radiant Heater (Indoor/Outdoor)

TEEH3524

Length: 61"      Volts: 240  
Watts: 3500      Amps: 14.6

## 39" & 61" Electric Radiant Heaters (Indoor/Outdoor)

Our Electric Heaters are the perfect addition to your backyard, patio, or deck. Extend your outdoor entertaining by maintaining a warm, comfortable atmosphere for you and your guests well into a cool evening. The heaters are suitable for both indoor and outdoor use and can be installed at lower mounting heights (6-8 ft.), helping to maximize the heat where you need it the most, especially in coastal areas.

- Energy Efficient — 90% of the input energy is converted directly to radiant heat.
- The parabolic reflector is made of a special corrosive resistant alloy, an important feature for humid climates or windy areas.
- Swivel mounting brackets allow 6" of clearance behind heater
- UL Approved



### Incremental Control

Wall mountable incremental control for easily regulated heat settings. (included with heaters.)

## HEATING AREA COVERAGE

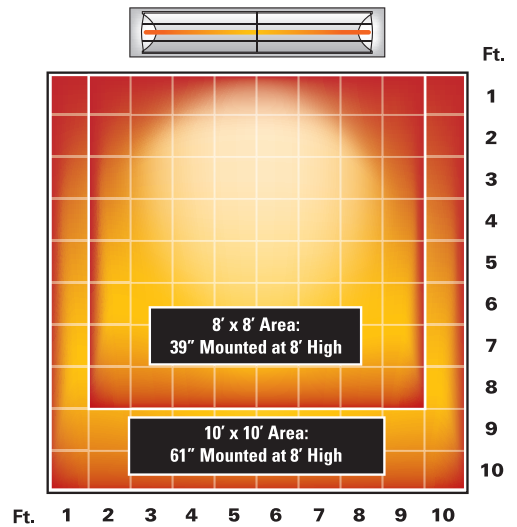

## Access Doors:

| Doors    | Cutout Dimensions |        |
|----------|-------------------|--------|
|          | A                 | B      |
| TEAD18-B | 16.25             | 19     |
| TEAD30-B | 28.25             | 19.375 |
| TEAD36-B | 34.25             | 19     |
| TEAD42-B | 40.25             | 19.375 |

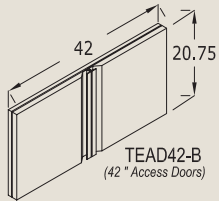
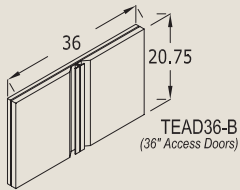
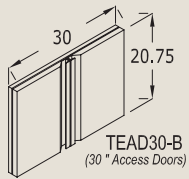
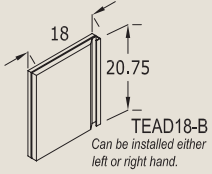

## TECHNICAL SPECIFICATIONS

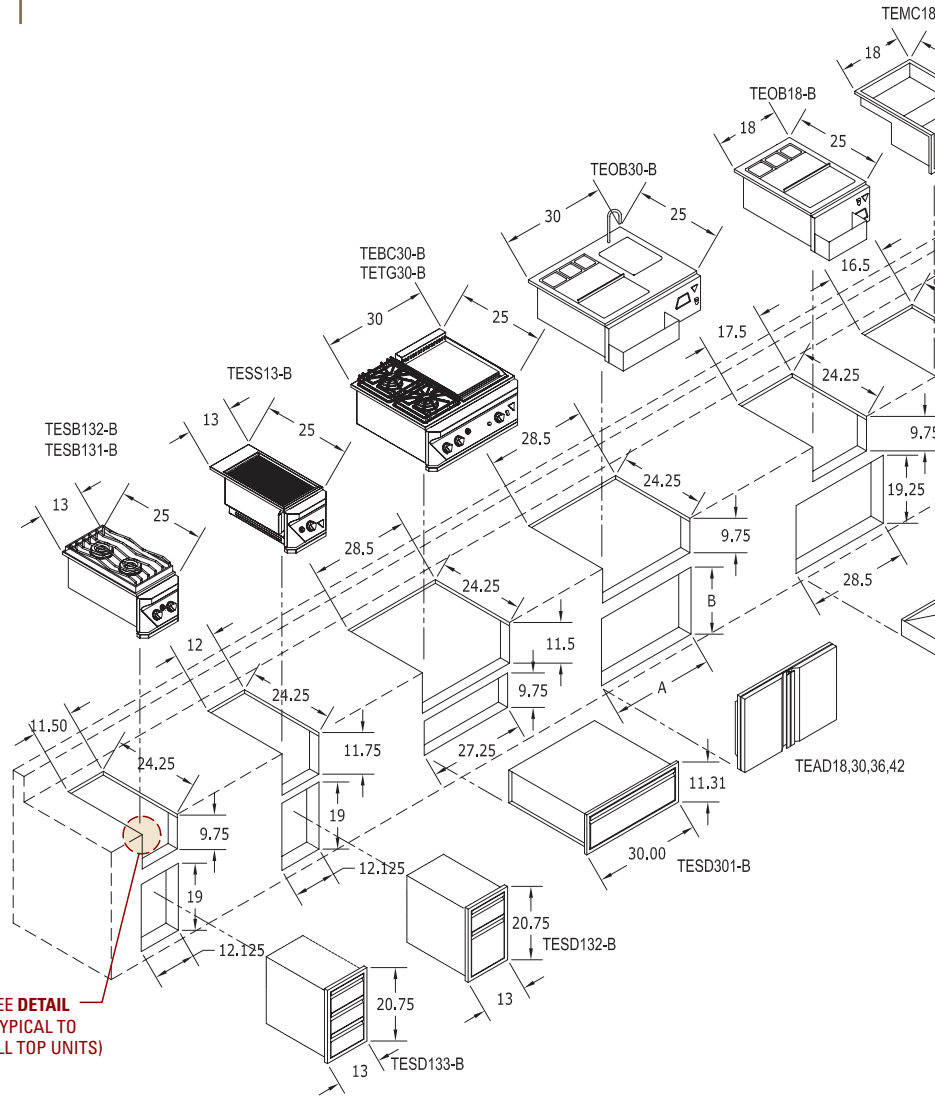

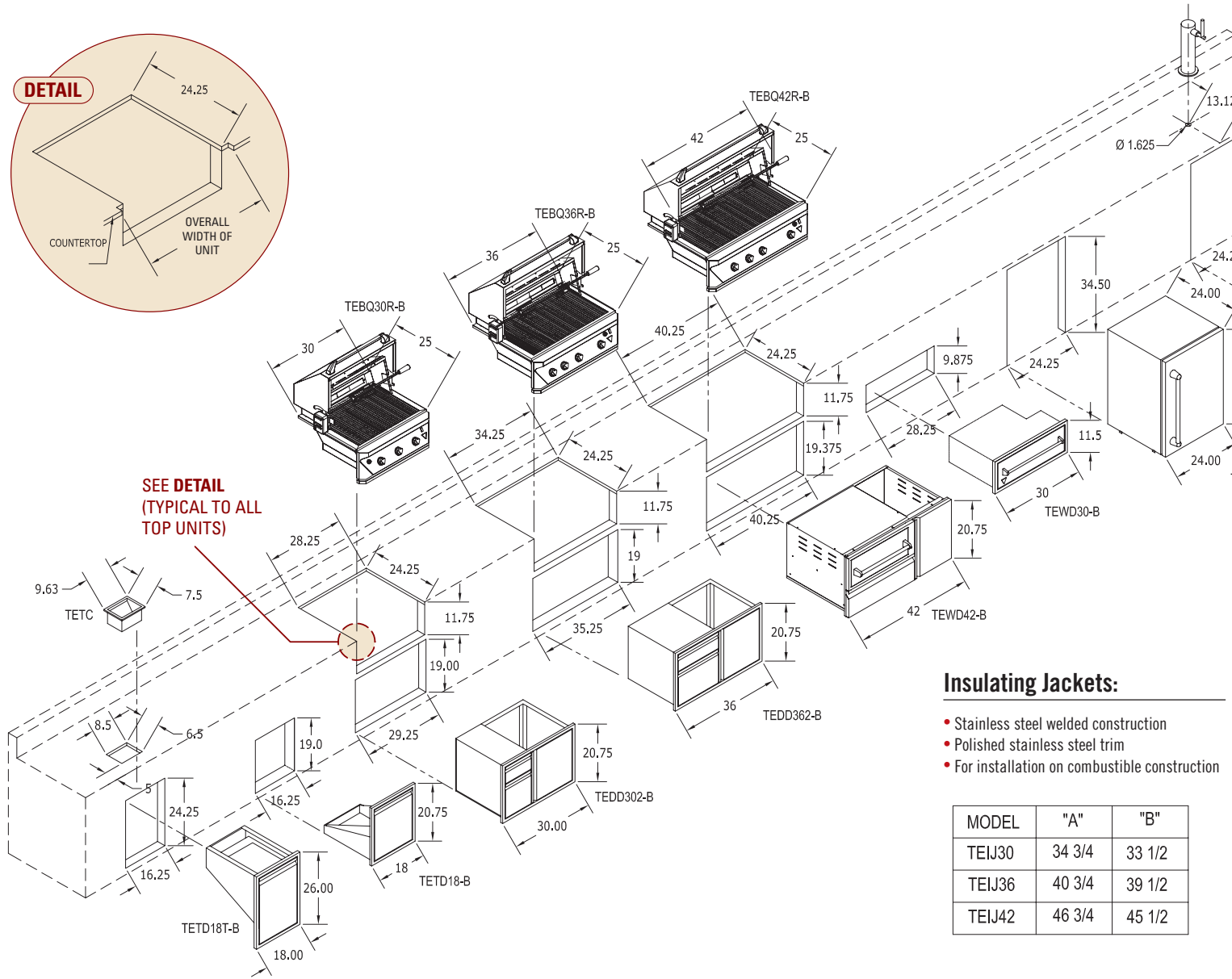
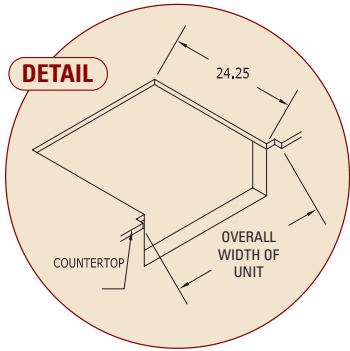

**Insulating Jackets:**

- Stainless steel welded construction
- Polished stainless steel trim
- For installation on combustible construction

| MODEL  | "A"    | "B"    |
|--------|--------|--------|
| TEIJ30 | 34 3/4 | 33 1/2 |
| TEIJ36 | 40 3/4 | 39 1/2 |
| TEIJ42 | 46 3/4 | 45 1/2 |



**TWIN EAGLES, INC.®**

**13231 East 166th Street**

**Cerritos, CA 90703**

**(800) 789-2206**

**[www.TwinEaglesBBQ.com](http://www.TwinEaglesBBQ.com)**

© 2009 Twin Eagles, Inc.® For the constant advancement of our products, Twin Eagles® reserves the right to change the specifications, designs, and materials of the products without prior notification.



Creative design, innovative engineering and impeccable quality control — a

Twin Eagles develops, from design to production, gas grills and outdoor kitchen state-of-the-art company owned facilities.

The Twin Eagles family consists of product designers, engineers and skilled craftsmen who create exquisite products and clearly...

*Defining the Art*



**MADE IN THE USA**