

This Owner's Manual is provided and hosted by [Appliance Factory Parts](#).



LG LRG3093ST Owner's Manual

[Shop genuine replacement parts for LG LRG3093ST](#)



[Find Your LG Gas Range Parts - Select From 55 Models](#)

----- Manual continues below -----



To contact LG Electronics, 24 hours a day,
7 days a week:

1-800-243-0000 (USA)

Or visit us on the Web at: us.lge.com (USA)

GAS RANGE

USER'S GUIDE

Please read this guide
thoroughly before
operating and keep it handy
for reference at all times.

Models

LRG3093ST
LRG3093SB
LRG3093SW



Printed in Mexico
P/No. MFL33029603

INTRODUCTION

IMPORTANT SAFETY INFORMATION

Important Safety Instructions.....	3
What to Do if You Smell Gas.....	3
Anti-Tip Device.....	3-4
Basic Safety Precautions.....	4-8

OPERATING INSTRUCTIONS

Parts and Features.....	9
Using the Gas Surface Burners.....	10-11
Control Panel—LRG3093S.....	12
Using the Oven.....	13-16
Using the Clock and Timer.....	17
Using the Timed Baking Features.....	18-19
Setting the Warm Feature.....	20
Setting the Proof Feature.....	20
Special Features of Your Oven Control.....	21-22
Using the Self-Cleaning Oven.....	23-24

CARE AND CLEANING OF THE RANGE

Care and Cleaning.....	25
Burner Caps and Heads.....	26
Burner Grates.....	27
Cooktop Surface.....	27
Stainless Steel Surfaces.....	28
Oven Air Vents.....	28
Control Panel.....	28
Front Manifold Panel and Knobs.....	28
Oven Door.....	29
Oven Bottom.....	30
Broiler Pan and Grid.....	30
Oven Racks.....	31
Oven Light Replacement.....	31
Removing & Replacing the storage drawer.....	32

TROUBLESHOOTING

Before Calling for Service.....	33-36
---------------------------------	-------

WARRANTY

Product Registration Information.....	37
---------------------------------------	----

THANK YOU!

Congratulations on your purchase and welcome to the LG family. Your new LG Gas Range combines precision cooking features with simple operation and stylish design. By following the operating and care instructions in this manual, your range will provide you with many years of reliable service.

Product Registration Information

Model: _____

Serial Number: _____

Date of Purchase: _____

IMPORTANT SAFETY INFORMATION

READ ALL INSTRUCTIONS BEFORE USE

IMPORTANT SAFETY INSTRUCTIONS

Read and follow all instructions before using your oven to prevent the risk of fire, electric shock, personal injury, or damage when using the range. This guide do not cover all possible conditions that may occur. Always contact your service agent or manufacturer about problems that you do not understand.



This is the safety alert symbol. This symbol alerts you to potential hazards that can kill or hurt you and others. All safety messages will follow the safety alert symbol and either the word "WARNING" or "CAUTION".



WARNING

This symbol will alert you to hazards or unsafe practices which could cause serious bodily harm or death.



CAUTION

This symbol will alert you to hazards or unsafe practices which could cause bodily injury or property damage.

WARNING: If the information in this manual is not followed exactly, a fire or explosion may result causing property damage, personal injury or death.

- DO NOT store or use gasoline or other flammable vapors and liquids in the vicinity of this or any other appliance.

WHAT TO DO IF YOU SMELL GAS

- Open windows.
- DO NOT try to light any appliance.
- DO NOT touch any electrical switch.
- DO NOT use any phone in your building.
- Immediately call your gas supplier from a neighbor's phone. Follow the gas supplier's instructions.
- If you cannot reach your gas supplier, call the fire department.

Installation and service must be performed by a qualified installer, service agency or the gas supplier.

ANTI-TIP DEVICE

WARNING



- ALL RANGES CAN TIP
- INJURY TO PERSONS COULD RESULT



- INSTALL ANTI-TIP DEVICES PACKED WITH RANGE
- SEE INSTALLATION



IMPORTANT SAFETY INFORMATION

READ ALL INSTRUCTIONS BEFORE USE

ANTI-TIP DEVICE (continued)

- **DO NOT step or sit on the door. Install the Anti-Tip Bracket packed with range.**
- The range could be tipped and injury might result from spilled hot liquid, food, or the range itself.
- If the range is pulled away from the wall for cleaning, service, or any other reason, ensure that the Anti-Tip Device is properly reengaged when the range is pushed back against the wall.

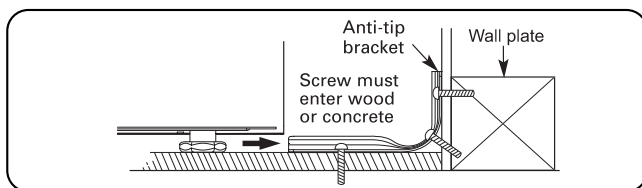

- To reduce the risk of tipping of the range, the range must be secured by properly installing anti-tip devices.
- To check that the anti-tip bracket is properly installed: Grasp the top rear edge of the range back guard and carefully attempt to tilt it forward. Verify that the anti-tip devices are engaged.
- Warming drawer or Storage drawer : Remove drawer and visually inspect that the rear leveling leg is fully inserted into the anti-tip bracket.
- Refer to the installation manual for proper anti-tip bracket installation.

IMPORTANT SAFETY NOTICE

Enforcement Act requires the Governor of California to publish a list of substances known to the state to cause birth defects or other reproductive harm, and requires businesses to warn customers of potential exposure to such substances.

Gas appliances can cause minor exposure to four of these substances, namely benzene, carbon monoxide, formaldehyde and soot, caused primarily by the imperfect combustion of natural or LP gas. Correctly adjusted burners, indicated by a bluish rather than a yellow flame, will minimize imperfect combustion. Exposure to these substances can be minimized by opening windows or using a ventilation fan or hood.

SAFETY PRECAUTIONS

Have the installer show you the location of the range gas shut-off valve and how to shut it off if necessary.

- Make sure your range is properly installed and grounded by a qualified installer, according to the installation instructions. Any adjustment and service should be performed only by qualified gas range installers or service technicians.
- Plug your range into a 120-volt grounded outlet only. Do not remove the round grounding prong from the plug. If in doubt about the grounding of the home electrical system, it is your personal responsibility and obligation to have an ungrounded outlet replaced with a properly grounded, three-prong outlet in accordance with the National Electrical Code. Do not use an extension cord with this range.
- **DO NOT** use an adapter plug, an extension cord, or remove grounding prong from electrical power cord to prevent fire hazard or electrical shock. Failure to follow this warning can cause serious injury, fire or death.
- To prevent poor air circulation, place the range out of kitchen traffic path and out of drafty locations.
- **DO NOT** attempt to repair or replace any part of your range unless it is specifically mentioned in this manual. All other service should be referred to a qualified technician.
- Make sure all packaging materials are removed from the range before operating it to prevent fire or smoke damage should the packaging material ignite.

IMPORTANT SAFETY INFORMATION

READ ALL INSTRUCTIONS BEFORE USE

SAFETY PRECAUTIONS (continued)

- Make sure your range is properly adjusted by a qualified service technician or installer for the type of gas (natural or LP) that is to be used. Your range can be converted for use with either type of gas. See the installation instructions.

⚠ WARNING: These adjustments must be done by a qualified service technician according to the manufacturer's instructions and all codes and requirements of the authority having jurisdiction. Failure to follow these instructions could result in serious injury or property damage. The qualified agency performing this work assumes responsibility for the conversion.

- After using your range for a long time, high floor temperatures may result and many floor coverings will not withstand this kind of use. Never install the range over vinyl tile or linoleum that cannot withstand such type of use. Never install it directly over interior kitchen carpeting.

⚠ CAUTION: Items of interest to children should not be placed in cabinets above a range or on the backsplash of a range—children climbing on the range to reach items could be seriously injured.

- **DO NOT** leave children alone or unattended where a range is hot or in operation. They could be seriously burned.
- **DO NOT** let anyone climb, stand or hang on the oven door, warming drawer or cooktop. They could damage the range and even tip it over, causing severe personal injury.

⚠ WARNING: **NEVER** use your range as a space heater to heat or warm the room. Doing so may result in carbon monoxide poisoning and overheating of the oven.

- **NEVER** wear loose fitting or hanging garments while using the appliance. Be careful when reaching for items placed in cabinets over the range. Flammable material could be ignited if brought in contact with flame or hot oven surfaces and may cause severe burns.

- **DO NOT** place flammable materials in an oven, a warming drawer or near a cooktop.
- **DO NOT** place or use combustible materials such as gasoline or other flammable vapors and liquids in the vicinity of this or any other appliance.
- **DO NOT** allow cooking grease or other flammable materials in or near the range.
- **DO NOT** use water on grease fires. Never touch a flaming pan. Turn the controls off. Smother a flaming pan on a surface burner by covering the pan completely with a well-fitting lid, cookie sheet or flat tray. Use a multi-purpose dry chemical or foam-type fire extinguisher.
A grease fire can be put out by covering it with baking soda or, if available, by using a multi-purpose dry chemical or foam-type fire extinguisher. Flame in the upper oven or lower oven drawer can be smothered completely by closing the oven door or drawer and turning the control to off or by using a multi-purpose dry chemical or foam-type fire extinguisher.
- **DO NOT** use the oven or the drawer for storage.
- Let the burner grates and other surfaces cool before touching them.
- **NEVER** block the vents (air holes) of the range. They provide the air inlet and outlet that are necessary for the range to operate properly with correct combustion. Air openings are located at the rear of the cooktop, at the top and bottom of the oven door, and at the bottom of the range under the warming drawer.
- Large scratches or impacts to glass doors can lead to broken or shattered glass.
- Stepping, leaning or sitting on the doors or drawers of this range can result in serious injuries and also cause damage to the range. Do not allow children to climb or play around the range. The weight of a child on an open door may cause the range to tip, resulting in serious burns or other injury.
- Leak testing of the appliance shall be conducted according to the manufacturer's instructions.

IMPORTANT SAFETY INFORMATION

READ ALL INSTRUCTIONS BEFORE USE

SURFACE BURNERS

WARNING:

- If the top burner flame goes out, gas is still flowing to the burner until the knob is turned to the “OFF” position. Do not leave the burners “ON” unattended.
- **Use proper pan size - DO NOT** use pans that are unstable or easily tipped. Select cookware having flat bottoms large enough to cover burner grates. To avoid spillovers, make sure cookware is large enough to contain the food properly. This will both save cleaning time and prevent hazardous accumulations of food, since heavy spattering or spillovers left on range can ignite. Use pans with handles that can be easily grasped and remain cool.

- **NEVER** leave the surface burners unattended at high flame settings. Boilovers cause smoking and greasy spillovers that may catch on fire.
- Always turn knob to the “LITE” position when igniting the top burners and make sure the burners have ignited.
- Control the top burner flame size so it does not extend beyond the edge of the cookware. Excessive flame is hazardous.
- Use only dry pot holders—moist or damp pot holders on hot surfaces may result in burns from steam. Do not let pot holders come near open flames when lifting cookware. Do not use a towel or other bulky cloth. Instead of a pot holder.
- Using glass cookware—make sure it is designed for top-of-range cooking.
- To prevent burns, ignition of flammable materials and spillage, turn cookware handles toward the side or back of the range without extending over adjacent burners.
- **NEVER** place any items on the cooktop. The hot air from the vent may ignite flammable items and will increase pressure in closed containers, which may cause them to burst.
- Carefully watch foods being fried at a high flame setting.
- Always heat fat slowly, and watch as it heats.
- If frying combinations of oils and fats stir together before heating.
- Use a deep fat thermometer if possible to prevent overheating fat beyond the smoking point.
- Use the least possible amount of fat for effective shallow or deep-fat frying. Filling the pan too full of fat can cause spillovers when food is added.
- **DO NOT** flame foods on the cooktop.
- **DO NOT** use a wok on the surface burners if the wok has a round metal ring that is placed over the burner grate to support the wok. This ring acts as a heat trap, which may damage the burner grate and burner head. Also, it may cause the burner to work improperly. This may cause a carbon monoxide level above that allowed by current standards, resulting in a health hazard.
- Foods for frying should be as dry as possible. Frost or moisture on foods can cause hot fat to bubble up and over the sides of the pan.
- **NEVER** try to move a pan of hot fat, especially a deep fat fryer. Wait until the fat is cool.
- **DO NOT** place plastic items on the cooktop—they may melt if left too close to the vent.
- Keep all plastics away from the surface burners.
- To prevent burns, always be sure that the controls for all burners are at the “OFF” position and all grates are cool before attempting to remove them.
- If you smell gas, turn off the gas to the range and call a qualified service technician. Never use an open flame to locate a leak.
- Always turn knob to the “OFF” position before removing cookware.
- **DO NOT** lift the cooktop. Lifting the cooktop can cause damage and improper operation of the range.
- If range is located near a window, do not hang long curtains that could blow over the surface burners and catch on fire.

IMPORTANT SAFETY INFORMATION

READ ALL INSTRUCTIONS BEFORE USE

COOK MEAT AND POULTRY THOROUGHLY

Cook meat and poultry thoroughly—meat to at least an INTERNAL temperature of 160°F and poultry to at least an INTERNAL temperature of 180°F.

To protect against foodborne illness, cook them to these temperatures.

SELF-CLEANING OVEN

- Make sure to wipe off excess spillage before self-cleaning operation.
- **DO NOT** use oven cleaners. No commercial oven cleaner or oven liner protective coating of any kind should be used in or around any part of the oven. Residue from oven cleaners will damage the inside of the oven when the self-clean cycle is used.
- Oven racks and accessories should be removed from the oven before self clean is started. Also remove any items placed in the bottom drawer before starting a self clean cycle.
- Clean only parts listed in this manual.
- **DO NOT** clean the door gasket. The door gasket is necessary for a good seal. Care should be taken not to rub, damage or move the gasket.
- If the self-cleaning mode malfunctions, turn the range off and disconnect the power supply. Let it serviced by a qualified technician.

IMPORTANT SAFETY INFORMATION

READ ALL INSTRUCTIONS BEFORE USE

OVEN

When opening the door of a hot oven, stand away from the range. The hot air and steam that escape can cause burns to hands, face and eyes.

⚠ WARNING: NEVER block any slots, holes or passages in the oven bottom or cover an entire rack with materials such as aluminum foil. Doing so blocks air flow through the oven and may cause carbon monoxide poisoning. Aluminum foil linings may also trap heat, causing a fire hazard.

- **DO NOT** heat closed food containers. Pressure could increase and the container could burst, causing an injury.
- **DO NOT** use aluminum foil anywhere in the oven except as described in this manual. Doing so could create a fire hazard or cause damage to the range.
- **DO NOT** use the oven for a storage area. Items stored in the oven can catch on fire.
- Keep the oven free from grease buildup.
- Insert the oven racks in the desired position while the oven is cool.
- To prevent burns when removing food, slide racks out until the stop engages, then remove food items. It is also a precaution against burns from touching hot surfaces of the door or oven walls.
- When placing or removing griddle always wear oven mitts.

- When using cooking or roasting bags in the oven, follow the manufacturer's directions.
- Use only glass cookware that is recommended for use in gas ovens.
- Always remove the broiler pan from the range after you finish broiling. Grease left in the pan can catch fire if oven is used without removing the grease from the broiler pan.
- When broiling, if meat is too close to the flame, the fat may ignite. To prevent excessive flare-ups, trim excess fat.
- Make sure the broiler pan is in place correctly to minimize the possibility of grease fires.
- If you should have a grease fire in the broiler pan, press the "**CLEAR OFF**" pad, and keep the oven door closed to contain fire until it burns out.
- For safety and better cooking performance, always bake and broil with the oven door closed.

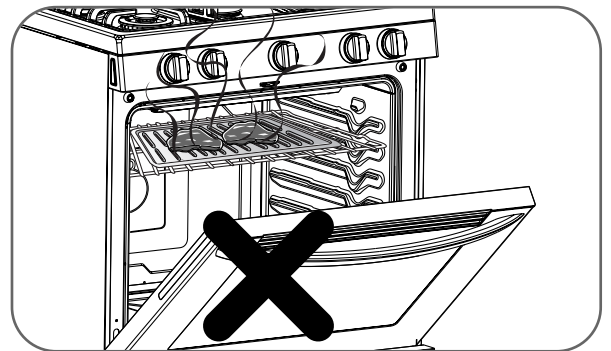

NOTE: Open door baking or broiling can cause damage to the knobs or valves.
DO NOT LEAVE THE OVEN DOOR OPEN DURING COOKING OR COOL DOWN.

**READ AND FOLLOW THIS SAFETY INFORMATION CAREFULLY.
SAVE THESE INSTRUCTIONS**

OPERATING INSTRUCTIONS

PARTS AND FEATURES

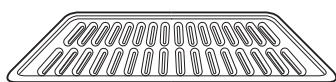
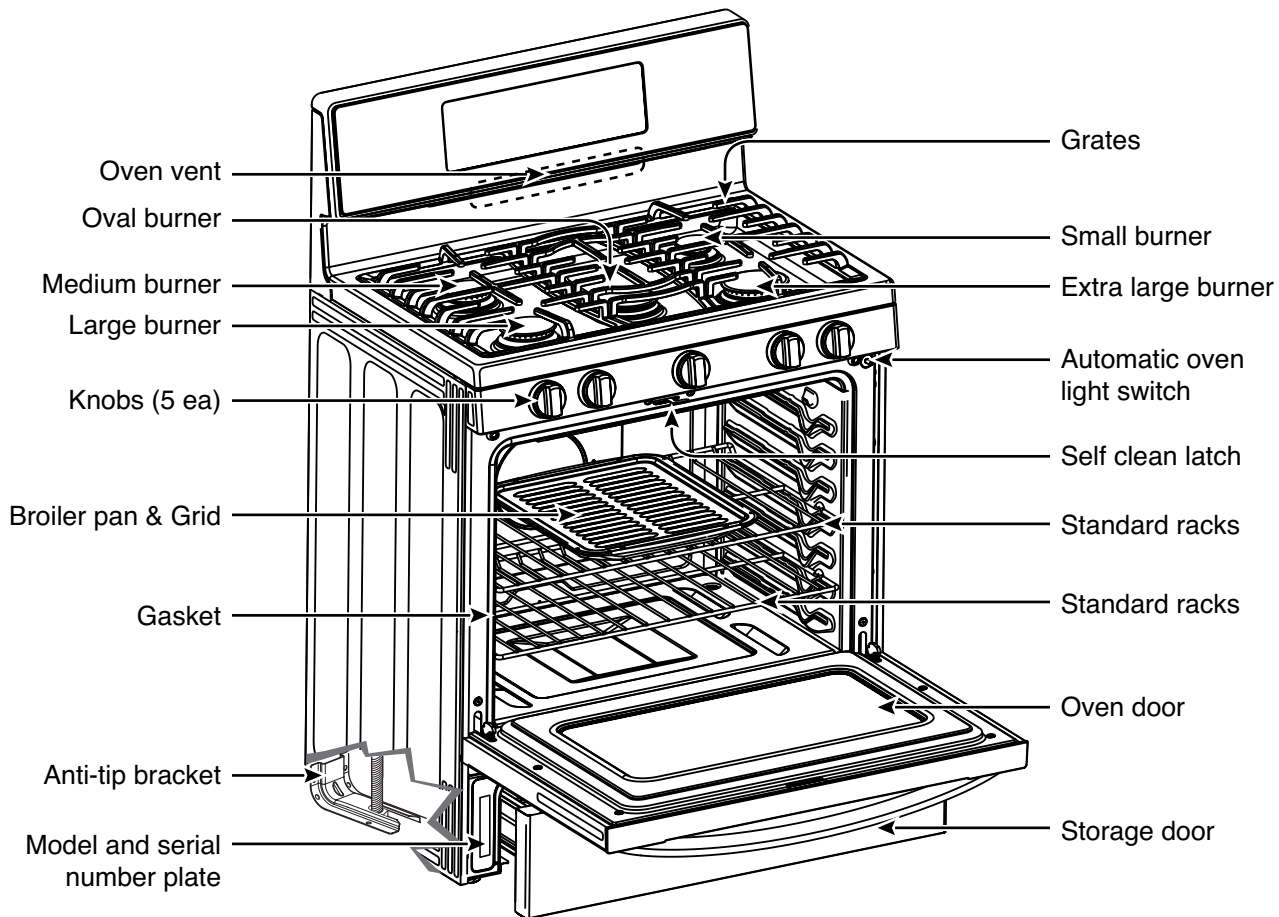

Grid

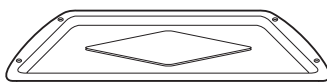

Broiler pan

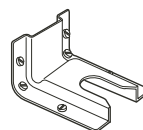

Anti-tip



Screws (6 ea)



Standard racks (2ea)

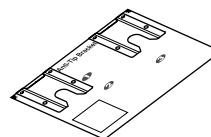

Template



Anchors (6 ea)

OPERATING INSTRUCTIONS

USING THE GAS SURFACE BURNERS

Throughout this manual, features and appearance may vary from your model.

- Make sure all grates on the range are properly placed before using any burner.
- Be sure the burners and grates are cooled down before you place your hand, a pot holder, cleaning cloths or other materials on them.
- Make sure all burners are in place.
- **DO NOT** operate the burner for an extended period of time without cookware on the grate. The finish on the grate may chip without cookware to absorb the heat.

HOW TO LIGHT A GAS SURFACE BURNER

- Be sure all the surface burners are placed in their respective positions.
- Push the control knob in and turn it to the “LITE” position.
- You will hear a little **clicking** noise— the sound of the electric spark igniting the burner.
- To control the flame size, turn the knob. If the knob stays at “LITE”, it will continue to click.
- When turning a burner to “LITE”, all the burners spark. Do not attempt to disassemble or clean around any burner while another burner is on. An electric shock may result, which could cause you to knock over hot cookware.

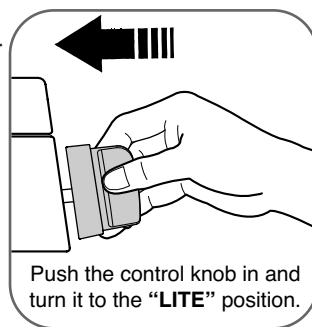

IN CASE OF POWER FAILURE

In case of a power failure, you can light the gas surface burners on your range with a match. Hold a lit match to the burner, then push in and turn the control knob to the “LITE” position. Use extreme caution when lighting burners this way. Surface burners in use when an electrical power failure occurs will continue to operate normally.

SEALED GAS BURNERS

Your gas range cooktop has five sealed gas burners. They offer convenience, cleanability and flexibility to be used in a wide range of cooking applications. The smallest burners are in the right rear position.

This burner can be turned down to a low simmer setting.

It provides precise cooking performance for delicate foods such as sauces or foods that require low heat for a long cooking time.

The medium (left rear) and the large (left front) burners are the primary burners for most cooking. These general-purpose burners can be turned down from “HI” to “LO” to suit a wide range of cooking needs.

The extra large burner (right front) is the maximum output burner. Like the other four burners, it can be turned down from “HI” to “LO” for a wide range of cooking applications.

This burner is also designed to quickly bring large amounts of liquid to a boil. It can be used with cookware 10 inches or larger in diameter.

The oval burner (center) is for use with a griddle or oval pots.

NOTE: The right front burner, by design, is raised up from the cooktop. This is normal.

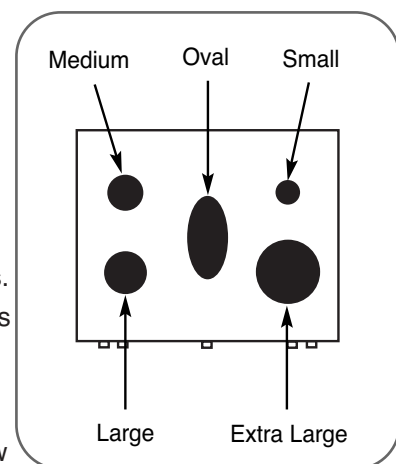

OPERATING INSTRUCTIONS

USING THE GAS SURFACE BURNERS

HOW TO SELECT FLAME SIZE

NEVER let the flames extend up the sides of the cookware for safe handling of cookware.

Watch the flame, not the knob, as you reduce heat. When fast heating is desired, the flame size on a gas burner should match the cookware you are using.

Flames larger than the bottom of the cookware will not result in faster heating of the cookware and could be hazardous.

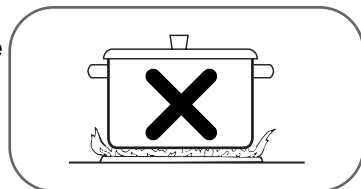

TOP-OF-RANGE COOKWARE

Aluminum: Medium-weight cookware is recommended because it heats quickly and evenly. Most of the foods brown evenly in an aluminum skillet. Use saucepans with tightfitting lids when cooking with minimum amounts of water.

Cast-Iron: If heated slowly, most skillets will give satisfactory results.

Stainless Steel: This metal alone has poor heating properties and is usually combined with copper, aluminum or other metals for improved heat distribution. Combination metal skillets usually work satisfactorily if they are used with medium heat as the manufacturer recommends.

Enamelware: Under some conditions, the enamel of some cookware may melt. Follow cookware manufacturer's recommendations for cooking methods.

Glass: There are two types of glass cookware—those for oven use only and those for top-of-range cooking (saucepans, coffee and teapots). Glass conducts heat very slowly.

Heatproof Glass Ceramic: Can be used for either surface or oven cooking. It conducts heat very slowly and cools very slowly. Check cookware manufacturer's directions to be sure it can be used on gas ranges.

USING A WOK

DO NOT use a wok support ring. Placing the ring over the burner or grate may cause the burner to work improperly, resulting in carbon monoxide levels above allowable standards.

This can be hazardous to your health.

Only a flat-bottomed wok should be used.

We recommend that you use a 14-inch or smaller flat-bottomed wok. Make sure the wok bottom sits flat on the grate. They are available at your local retail store.

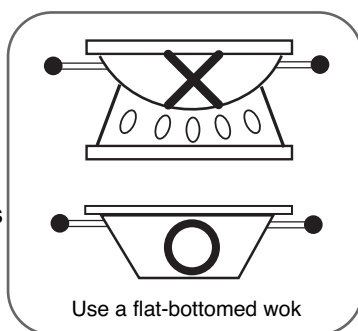

STOVE-TOP GRILLS

DO NOT use stove top grills on your surface burners. If you use the stove top grill on the surface burner, it will cause incomplete combustion and can result in exposure to carbon monoxide levels above allowable current standards.

This can be hazardous to your health.

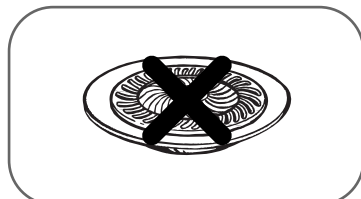

OPERATING INSTRUCTIONS

CONTROL PANEL—LRG3093S

Throughout this manual, features and appearance may vary from your model.

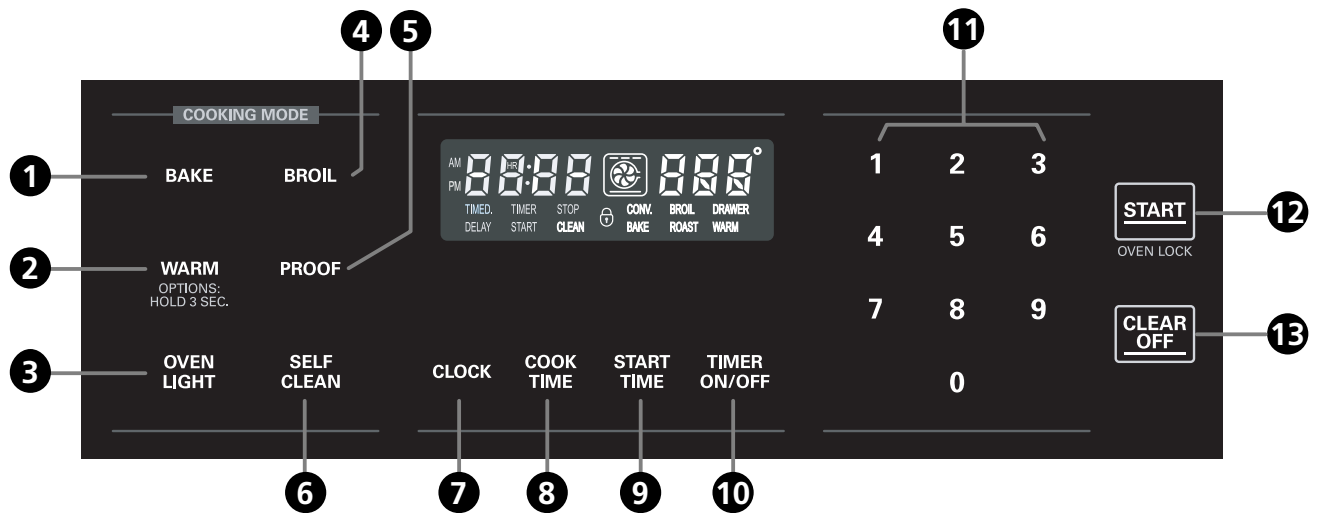

OVEN CONTROL, CLOCK, AND TIMER FEATURES

- 1 BAKE PAD** – Press the pad to enter the normal bake function.
- 2 WARM PAD / OPTIONS**
 - Press this pad to hold food warm in the oven.
 - Press and hold the pad for 3 seconds to change the special settings.**NOTE:** Special settings can only be used if no other function (Bake, Broil, Timer Ect.) of the control panel is in use.
- 3 OVEN LIGHT PAD** – Press the pad to turn the oven light on or off.
- 4 BROIL PAD** – Press the pad to select broil function.
- 5 PROOF PAD** – Press the pad to proof bread.
- 6 SELF CLEAN PAD** – Press the pad to select self-cleaning function.
- 7 CLOCK PAD** – Press the pad to set the time of day.
- 8 COOK TIME PAD** – Press this pad and then press the number pads to set the amount of time you want your food to cook. The oven will shut off when the cooking time has run out.
- 9 START TIME PAD** – Press this pad and then press the number pad to set delayed start time. The oven will start at a time you set.
- 10 TIMER ON/OFF PAD** – Press the pad to set or cancel the timer function.
- 11 NUMBER PADS** – Use to set any function requiring numbers such as clock, timer or temperature.
- 12 START PAD / OVEN LOCK**
 - Press the pad to start all oven features.
 - Press and hold the pad for 3 seconds to activate/deactivate the Oven Lockout function.
- 13 CLEAR OFF PAD** – Press this pad to cancel ALL oven operations except the clock, timer and warming drawer settings.

OPERATING INSTRUCTIONS

USING THE OVEN

BEFORE YOU BEGIN

The oven has 7 rack positions for various types of cooking.

To install a rack insert the curved end of the rack into the desired position and push all the way back.

To remove a rack pull out until the rack stops, then tilt up and pull out.

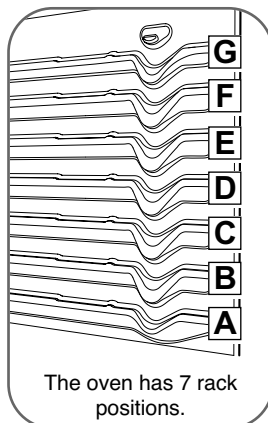

CAUTION: Always use potholders or oven mitts when removing food or adjusting the oven racks. Wait until the oven has completely cooled if possible. Oven racks may be HOT and may cause burns.

OVEN VENT

Your oven is vented through ducts at the center above the burner grate. Do not block the oven vent when cooking to allow for proper air flow. Do not touch vent openings or nearby surfaces during the use of any cooking operation.

- **DO NOT** place plastic or flammable items on the cooktop—they may melt or ignite if left too close to the vent.
- **DO NOT** place closed containers on the cooktop. The pressure in closed containers may increase, which may cause them to burst.
- Metal items will become very hot if they are left on the cooktop, and could cause burns.
- Handles of pots and pans on the cooktop may become hot if left too close to the vent.



POWER OUTAGE

CAUTION:

DO NOT attempt to operate the electric ignition oven during an electrical power failure.

The oven or broiler can not be used during a power outage.

If the oven is in use when a power failure occurs, the oven burner shuts off and cannot be re-lit until power is restored. Once power is restored you will need to restart the oven or broil function.

OVEN LIGHT

OVEN LIGHT The oven light automatically turns ON when the door is opened. The oven light may also be manually turned ON or OFF by pressing the “OVEN LIGHT” pad.

NOTE :

- The oven light can not be turned on during a self clean cycle. The oven light can not be turned on until the oven temperature has cooled below 500° F (260° C) after a self clean cycle is complete.

OVEN MOISTURE

As your oven heats up, the temperature increase of the air in the oven may cause water droplets to form on the door glass. These droplets are harmless and will evaporate as the oven continues to heat up.

ALUMINUM FOIL

NEVER cover the oven bottom with aluminum foil.

Aluminum foil may also be used to catch a spillover. To do so, place a small sheet of foil on a lower rack several inches below the food.

NEVER entirely cover a rack with aluminum foil. This will disturb the heat circulation and result in poor baking.

OPERATING INSTRUCTIONS

USING THE OVEN

To avoid possible burns, place the racks in the desired position before you turn the oven on.

HOW TO SET THE OVEN FOR BAKING OR ROASTING

Your oven is not designed for open-door cooking.

BAKE

- 1 Press the “**BAKE**” pad.

1 2 3

- 2 Press the **number** pads to set the desired temperature.

START

- 3 Press the “**START**” pad.

The word “**BAKE**” and **100°** will be displayed. As the oven heats up, the display will show the changing temperature. After the oven has reached the desired temperature, long beeps will sound 5 times and oven lamp will flash.

To change the oven temperature during a **BAKE** cycle, press the “**BAKE**” pad and then the number pads to set the new temperature.

- 4 Check food for doneness at minimum time on recipe. Cook longer if necessary.

CLEAR OFF

- 5 Press the “**CLEAR OFF**” pad when cooking is complete.

BAKING TIP

THE TYPE OF MARGARINE WILL AFFECT BAKING PERFORMANCE

Most recipes for baking have been developed using high fat products such as butter or margarine (80% fat). To decrease the fat, the recipe may not give the same results as with a higher fat product.

It can result in recipe failure if cakes, pies, pastries, cookies or candies are made with low fat spreads. The lower the fat content of a spread product, the more noticeable these differences become.

Federal standards require products labeled “margarine” to contain at least 80% fat by weight. Low fat spreads, on the other hand, contain less fat and more water. The high moisture content of these spreads affects the texture and flavor of baked goods. It can get best results with your old favorite recipes to use margarine, butter or stick spreads containing at least 70% vegetable oil.

PREHEATING AND PAN PLACEMENT

Preheat the oven if the recipe calls for it. To preheat, set the oven at the correct temperature. Preheating is necessary when convection baking and for good results when baking cakes, cookies, pastry and breads.

Baking results will be better if baking pans are centered in the oven as much as possible. If baking with more than one pan, place the pans so each has at least 1” to 1-1/2” of air space around it.

If cooking on multiple racks, place the oven racks in positions C and E (For 2 racks) Place the cookware as shown in Fig. 1, 2.

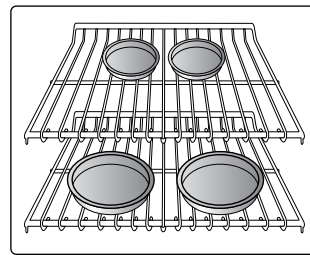

Fig. 1

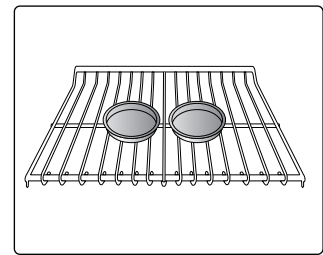

Fig. 2

Type of Food	Rack Position
Frozen pies (on cookie sheet)	B or C
Angel food cake, bundt or pound cakes	C
Biscuits, muffins, brownies, cookies, cupcakes, layer cakes, pies	D
Casseroles	D
Roasting	A

OPERATING INSTRUCTIONS

USING THE OVEN

HOW TO SET THE OVEN FOR BROILING

Your oven is designed for CLOSED DOOR broiling.

- 1 Place the food on the grid of the broiler pan.
- 2 Follow suggested rack positions in the **Broiling Guide**.
- 3 The oven door **must** be closed to begin broiling. The oven door **must** be closed during broiling.

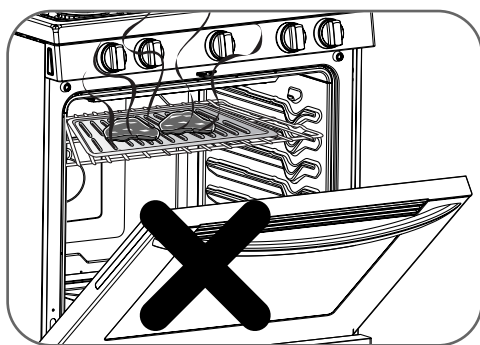

NOTE: If the oven door remains open for more than 15 seconds during broil the burner will shut off. The broil burner will automatically come back on once the door is closed.

BROIL

- 4 Press the “**BROIL**” pad once for “**Hi**” and twice for “**Lo**”.

START

- 5 Press the “**START**” pad.

CLEAR OFF

- 6 When broiling is finished, press the “**CLEAR OFF**” pad.

CAUTION:

- **DO NOT** use the broiler pan without the grid.
- **DO NOT** cover the broil pan or grid with aluminum foil. Exposed grease could ignite.
- To prevent food from contacting the broil burner and to prevent grease splattering, do not use the roasting rack when broiling.

Serve the food immediately, and place the pan outside the oven to cool during the meal for easiest cleaning.

Use **LO Broil** to cook foods such as poultry or thick cuts of meat thoroughly without over-browning them.



Always use the broiler pan and grid that came with your oven.

It is designed to minimize smoking and spattering by trapping juices in the shielded lower part of the pan.

NOTE :

- Some smoke may occur during broiling. This is normal.

OPERATING INSTRUCTIONS

USING THE OVEN

BROILING GUIDE

Broiling times will be affected by the size, weight, thickness, starting temperature and your preference of doneness. This guide is based on meats at refrigerated temperatures.

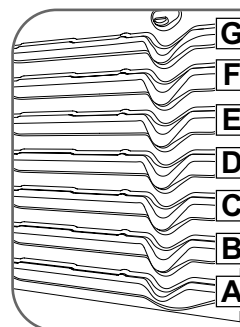

Your oven has 7 rack positions.

Food	Quantity and/or Thickness	Rack Position	First Side Time (min.)	Second Side Time (min.)	Comments
Ground Beef Well Done	1 lb. (4 patties) 1/2 to 3/4" thick	F	7~8	5-6	Space evenly. Up to 8 patties may be broiled at once.
Beef Steaks Rare Medium Well Done	1" thick 1 to 1 1/2 lb.	F F F	7 12 13	5 5-6 8-9	Steaks less than 1" thick cook through before browning. Pan frying is recommended. Slash fat.
Rare Medium Well Done	1 1/2" thick 2 to 2 1/2 lb.	D D D	10 12-15 25	6-7 10-12 16-18	
Bacon	1/2 lb. (about 8 thin slices)	D	8	3	Arrange in single layer.
Pork Chops Well Done	2 (1/2" thick.) 2 (1" thick) about 1 lb.	D D	10 13	8 8~9	Slash fat.
Lamb Chops Medium Well Done	2 (1" thick) about 10 to 12 oz.	E E	6 10	4-7 10	Slash fat.
Medium Well Done	2 (1 1/2" thick) about 1 lb	E E	10 17	4-6 12-14	
Chicken	1 whole 2 to 2 1/2 lbs., split lengthwise 4 bone-in breasts	B B	35-40 25-30	25 10-15	Brush each side with melted butter. Broil skin-side-down first.
Lobster Tails	2-4 6 to 8 oz. each	C	13-16	Do not turn over.	Cut through back of shell. Spread open. Brush with melted butter before broiling and after half of broiling time.
Fish Fillets	1/4 to 1/2" thick	E	7~8	6	Handle and turn very carefully. Brush with lemon butter before and during cooking, if desired. Preheat broiler to increase browning.
Ham Slices (precooked)	1" thick 1/2" thick	C D	10 7	5 4	Increase time 5 to 10 minutes per side for 1 1/2" thick or home-cured ham.

† The U.S. Department of Agriculture says "Rare beef is popular, but you should know that cooking it to only 140°F(60°C). means some food poisoning organisms may survive." (Source: *Safe Food Book, Your Kitchen Guide*. USDA Rev. June 1985.)

* See illustration for description of rack positions.

USING THE CLOCK AND TIMER

HOW TO SET THE CLOCK

The clock should be set to the correct time of day for the automatic oven timing functions to work properly. The time of day cannot be changed during cooking or self-clean mode.

- CLOCK**
- 1 Press the “**CLOCK**” pad once to set.
 - 2 Press the **number** pads to enter the time. Press the number pads the same way you read them. For example, to set 12:12, press the number pads **1, 2, 1,** and **2** in that order.
If number pads are not pressed within 30 seconds after you press the “**CLOCK**” pad, the display reverts to the original setting. If this happens, press the “**CLOCK**” pad and reenter the time of day.
 - 3 Press the “**START**” pad.

To check the time of day when the display is showing other information, simply press the “**CLOCK**” pad.

HOW TO CHANGE HOUR MODE ON CLOCK (12HR OR 24HR)

Your control is set to use a 12-hour clock. If you would prefer to have a 24-hour time clock, follow the steps below.

- CLOCK**
- 1 Press the “**CLOCK**” pad for 3 seconds.
 - 2 Press the number **1** pad once for 12hr and twice for 24hr.
 - 3 Press the “**START**” pad to accept the desired change.

HOW TO SET THE TIMER

The timer does not control oven operations. The maximum setting on the timer is 11 hours and 59 minutes.

- TIMER ON/OFF**
- 1 Press the “**TIMER ON/OFF**” pad once for minutes and seconds, press the pad twice for hours and minutes.
 - 2 Press the **number** pad to select the desired time. A maximum of 59 minutes can be set using the minutes and seconds function. To set times longer than 59 minutes use the hours and minute function (press the pad twice).
- NOTE:** If you make a mistake, press the “**TIMER ON/OFF**” pad and begin again.
- TIMER ON/OFF**
- 3 Press the “**TIMER ON/OFF**” pad to start the countdown.
- NOTE:** If “**TIMER ON/OFF**” is not pressed the timer will return to the time of day.
- TIMER ON/OFF**
- 4 When the timer reaches **:00**, “**End**” will show in the display. The clock will sound with 3 beeps every 15 seconds until “**TIMER ON/OFF**” pad is pressed.

NOTE: If the remaining time is not in the display, recall the remaining time by pressing the “**TIMER ON/OFF**”.

HOW TO CANCEL THE TIMER

Press the “**TIMER ON/OFF**” pad.

POWER OUTAGE

If a flashing time is in the display, you have experienced a power failure. You will need to reset the clock time.

Press the “**CLOCK**” pad once to reset. Enter the correct time of day by pressing the appropriate number pads. Press the “**START**” pad.

OPERATING INSTRUCTIONS

USING THE TIMED BAKING FEATURES

NOTE: DO NOT leave foods that spoil easily – such as milk, eggs, fish, stuffings, poultry and pork – more than 1 hour before or after cooking. Room temperature promotes the growth of harmful bacteria. Be sure that the oven light is off because heat from the bulb will speed harmful bacteria growth.

HOW TO SET AN IMMEDIATE START AND AUTOMATIC STOP

The oven will turn on immediately and cook for a selected length of time. At the end of the cooking time, the oven will turn off automatically.

BAKE

1 Press the “**BAKE**” pad.

1 2 3

2 Press the **number** pads to set the desired oven temperature.

COOK TIME

3 Press the “**COOK TIME**” pad.

NOTE: If your recipe requires preheating, you may need to add additional time to the length of the cooking time.

1 2 3

4 Press the **number** pads to set the desired length of cooking time.

The cooking time you can set is between 1 minute to 11 hours and 59minutes.

To enter a cooking time of 1 hr 30 minutes, press **1, 3, 0**.

The entered oven temperature and the cooking time will be shown in the display.

START

5 Press the “**START**” pad.

The oven will turn **ON**, and the display will show the cooking time countdown and the changing temperature starting at 100°F(38°C).

After the oven has reached the desired temperature, long beeps will sound 5 times and oven lamp will flash.

The oven will continue to cook for the set amount of time, then turn off automatically, unless the **WARM FEATURE** was set. See the “**SETTING THE WARM FEATURE**” section.

After the oven turns off, the control will continue to beep 3 times every 1 minute until “**CLEAR OFF**” pad is pressed.

CLEAR OFF

6 Press the “**CLEAR OFF**” pad to clear the display. Remove the food from the oven. Remember, although the oven turns off automatically, food left in the oven will continue cooking after the oven turns off.

USING THE TIMED BAKING FEATURES (continued)

HOW TO SET A DELAYED START AND AUTOMATIC STOP

The oven will turn on at the time of day you set, cook for a specific length of time and then turn off automatically.

Be sure the clock shows the correct time of day.

BAKE

1 Press the “**BAKE**” pad.

1 2 3

2 Press the **number** pads to set the desired oven temperature.

COOK TIME

3 Press the “**COOK TIME**” pad.

NOTE: If your recipe requires preheating, you may need to add additional time to the length of the cooking time.

1 2 3

4 Press the **number** pads to set the desired length of cooking time. To enter a cooking time of 1 hr 30 minutes, press **1, 3, 0**. The entered oven temperature and the cooking time will be shown in the display.

START TIME

5 Press the “**START TIME**” pad.

1 2 3

6 Press the **number** pads to set the time of day you want the oven to turn on and start cooking.

START

7 Press the “**START**” pad.

NOTE: If you would like to check the times you have set, press the “**START TIME**” pad to check the start time you have set or press the “**COOK TIME**” pad to check the length of cooking time you have set.

The oven will turn **ON**, and the display will show the cooking time countdown and the changing temperature starting at 100°F(38°C). After the oven has reached the desired temperature, long beeps will sound 5 times and oven lamp will flash.

The oven will continue to cook for the set amount of time, then turn off automatically, unless the **WARM FEATURE** was set. See the “**SETTING THE WARM FEATURE**” section.

After the oven turns off, the end-of-cycle tone will sound.

CLEAR OFF



8 Press the “**CLEAR OFF**” pad to clear the display. Remove the food from the oven. Remember, although the oven turns off automatically, food left in the oven will continue cooking after the oven turns off.

OPERATING INSTRUCTIONS



SETTING THE WARM FEATURE

The WARM feature will maintain an oven temperature of 170°F(77°C). This feature should not be used to reheat cold foods. The Warm feature will keep cooked food warm for serving up to 3 hours after cooking has finished. After 3 hours the WARM feature will shut the oven OFF automatically. The Warm feature may be used without any other cooking operations or can be used after cooking has finished using TIMED BAKE (CONV. BAKE, CONV. ROAST) or DELAYED TIMED BAKE (CONV. BAKE, CONV. ROAST).

HOW TO SET WARM

-  1 Press the “WARM” pad.
-  2 Press the “START” pad.
-  3 To turn Warm off, press the “CLEAR OFF” at any time.

HOW TO SET WARM FEATURE WHEN TIMED COOKING

- 1 Set the cooking feature that you want to use: TIMED (BAKE, CONV. BAKE, CONV. ROAST), DELAY TIMED (BAKE, CONV. BAKE, CONV. ROAST) refer to the relevant previous page.
-  2 Press the “START” pad.
-  3 Press the “WARM” pad. WARM mode is set to turn on automatically after completing the TIMED COOKING or DELAY TIMED COOKING.
-  4 To turn Warm off at any time press the “CLEAR OFF” pad.



NOTE: If “CLEAR OFF” is pressed prior to the delay functions starting all settings will be canceled.

SETTING THE PROOF FEATURE

The Proof feature maintains a warm environment for rising yeast leavened products before baking.

- 1 Place the covered dough in a dish in the oven on rack B or C.

NOTE: For best results, cover the dough with a cloth or with plastic wrap (the plastic may need to be anchored underneath the container so the oven fan will not blow it off).

-  2 Press the “PROOF” pad. PROOF will be displayed.
-  3 Press the “START” pad.
-  4 When proofing is finished, press the “CLEAR OFF” pad.

To avoid lowering the oven temperature and lengthening proofing time, do not open the oven door unnecessarily. Check bread products early to avoid over-proofing.

NOTES:

- **DO NOT** use the proofing mode for warming food or keeping food hot. The proofing oven temperature is not hot enough to hold foods at safe temperatures. Use the WARM feature to keep food warm.
- Proofing will not operate when oven is above 125°F(52°C). Oven is Hot will show in the display.

OPERATING INSTRUCTIONS

SPECIAL FEATURES OF YOUR OVEN CONTROL

Your new control has additional features that you may choose to use. The following pages describe these features and how you may activate them.

The special feature modes can only be activated while the display is showing the time of day.

They remain in the control's memory until the steps are repeated.

When the display shows your choice, press the "START" pad. The special features will remain in memory after a power failure.

HOW TO ADJUST THE OVEN THERMOSTAT

You may find that your new oven cooks differently than the one it replaced. Use your new oven for a few weeks to become more familiar with it. If you still think your new oven is too hot or too cold, you can adjust the thermostat yourself.

DO NOT use thermometers, such as those found in grocery stores, to check the temperature setting of your oven. These thermometers may vary 20–40 degrees.

NOTE: This adjustment will not affect the broiling or the self-cleaning temperatures. The adjustment will be retained in memory after a power failure.

The oven temperature can be increased (+) or decreased (-) as much as 35°F or 19°C.

To increase(+) temperature adjustment

WARM
OPTIONS:
HOLD 3 SEC.

- 1 Press and hold the "WARM" pad for 3 seconds and "Adj" will display.

1 2 3

- 2 Using the **number** pad, enter the temperature amount you wish to increase(+).
For example, to increase(+) the oven temperature 15, press 1 and 5.

START

- 3 Press the "START" pad to set the increased (+) temperature.

To decrease(-) temperature adjustment

WARM
OPTIONS:
HOLD 3 SEC.

- 1 Press and hold the "WARM" pad for 3 seconds "Adj" will display.

1 2 3

- 2 Using the **number** pad, enter the temperature amount you wish to decrease(-).
For example, to decrease(-) the oven temperature 15, press 1 and 5.

WARM
OPTIONS:
HOLD 3 SEC.

- 3 Press the "WARM" pad again, the decreased(-) temperature will appear in the display.

START

- 4 Press the "START" pad to set the increased (+) temperature.

NOTE: Once the temperature is increased or decreased, the display will show the adjusted temperature until it is readjusted.

NOTE: The thermostat adjustment will change the temperature for bake, roast, convection bake and convection roast.

OPERATING INSTRUCTIONS

SPECIAL FEATURES OF YOUR OVEN CONTROL

HOW TO SET PREHEATING ALARM LIGHT ON/OFF

The interior oven light automatically turn on when the oven door is opened.

When oven reaches set-temperature after preheat, the oven notifies preheat-end by flashing oven lamp until the door is opened.

You can activate or deactivate the smart oven light feature. Default Setting is on.



- 1 Press and hold the “**WARM**” pad for 3 seconds. Then press the “**WARM**” pad once and “PrE” will display.



- 2 Press the **number 1** to switch between ON and OFF.



- 3 Press the “**START**” pad to accept the change.

HOW TO ADJUST BEEPER VOLUME

The beeper volume feature allows you to adjust the volumes to a more acceptable volume. There are four possible volume levels, Hi, Med, Lo and Off.



- 1 Press and hold the “**WARM**” pad for 3 seconds. Then press the “**WARM**” pad twice and “BEEP” will display.



- 2 Press the **number 1** Key pad to toggle between the various beeper volumes.



- 3 Press the “**START**” pad to accept the change.

NOTE:

When the display reads:
Hi or **3** = Highest volume
-- or **2** = Normal volume
Lo or **1** = Lowest volume
Off = Mute

HOW TO SELECT FAHRENHEIT OR CELSIUS TEMPERATURE

Your oven control is set to use the Fahrenheit temperature selections but you may change this to use the Celsius selections.



- 1 Press and hold the “**WARM**” pad for 3 seconds. Then press the “**WARM**” pad 3 times and “Unit” will display.



- 2 Press the **number 1** to switch between the F and C.



- 3 Press the “**START**” pad to accept the change.

USING THE SELF-CLEANING OVEN

BEFORE A CLEAN CYCLE

When running a self clean cycle, it is recommended that a kitchen window be opened or the use of ventilation fan or hood be used.

Remove the oven racks, broiler pan, broiler grid, all cookware and any aluminum foil from the oven—they cannot withstand the high cleaning temperatures.

IMPORTANT: *The health of some birds is extremely sensitive to the fumes given off during the self-cleaning cycle of any range. Move birds to another well ventilated room.*

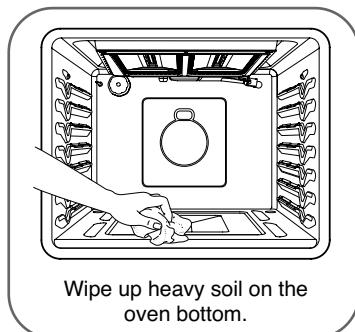

NOTES:

- Soil on the front frame of the range and outside the gasket on the door will need to be cleaned by hand. Clean these areas with hot water, soap-filled scouring pads or cleansers such as Soft Scrub. Rinse well with clean water and dry.
- **DO NOT** clean the gasket. The fiberglass material of the oven door gasket cannot withstand abrasion. It is essential for the gasket to remain intact. If you notice it becoming worn or frayed, replace it.
- Wipe up any heavy spillovers on the oven bottom.
- Make sure the oven light bulb cover is in place and the oven light is off.
- Use caution when opening the oven after the self-clean cycle has ended. The oven may still be hot.

HOW TO SET THE OVEN FOR CLEANING

**SELF
CLEAN**

- 1 Press the “**SELF CLEAN**” pad once for a 3 hour cycle, twice for a 2 hour cycle or three times for a 4 hour cycle. A 3-hour self-clean is recommended for use when cleaning small, contained spills. A SELF CLEAN time of 4 hours is recommended for heavily soiled ovens.

START

- 2 Press the “**START**” pad.

The door locks automatically. The display will show the clean time remaining. It will not be possible to open the oven door until the temperature drops below the lock temperature and the **DOOR LOCKED** light goes off.

The oven shuts off automatically when the clean cycle is complete.

- 3 When the **DOOR LOCKED** light is off, the door will unlock automatically.
- The words **DOOR LOCKED** will flash and the oven control will signal if you set the clean cycle and forget to close the oven door.
 - To stop a clean cycle, press the “**CLEAR OFF**” pad. When the **DOOR LOCKED** light goes off indicating the oven has cooled below the locking temperature, open the door.

OPERATING INSTRUCTIONS

USING THE SELF-CLEANING OVEN

The oven door must be closed and all controls set correctly for the cycle to work properly.

HOW TO DELAY THE START OF CLEANING

Make sure the clock shows the correct time of day.

- SELF CLEAN**
- 1 Press the “**SELF CLEAN**” pad.
Select the desired self clean time by pressing the “**SELF CLEAN**” pad.
- START TIME**
- 2 Press the “**START TIME**” pad.
Enter the desired Self-Clean starting time of day using the number pads.
- START**
- 3 Press the “**START**” pad. “**DELAY**” and “**CLEAN**” will remain on.

The door locks automatically. The display will show the start time. Self-Cleaning cycle will turn on automatically at the set time. At that time the icon “**DELAY**” will go out. It will not be possible to open the oven door until the temperature drops below the lock temperature and the **DOOR LOCKED** light goes off.

⚠ WARNING:

During the self-clean cycle, the outside of the appliance can become very hot to the touch. Do not leave small children unattended near the appliance.

The oven shuts off automatically when the clean cycle is complete.

- When the **DOOR LOCKED** light is off, the door will unlock automatically.
- The words **DOOR LOCKED** will flash and the oven control will signal if you set the clean cycle and forget to close the oven door.
- To stop a clean cycle, press the “**CLEAR OFF**” pad. When the **DOOR LOCKED** light goes off indicating the oven has cooled below the locking temperature, open the door.

⚠ CAUTION:

- **DO NOT** line the oven walls, oven racks, bottom or any other part of the range with aluminum foil. Doing so will stop heat distribution, produce poor baking results and cause permanent damage to the oven interior (aluminum foil will melt to the interior surface of the oven).
- Use caution when opening the door after the self-clean cycle is finished. The oven may still be **VERY HOT**.
- The health of some birds is extremely sensitive to the fumes given off during the self-cleaning cycle of any range. Move birds to another well-ventilated room.

AFTER A CLEAN CYCLE

- You may notice some white ash in the oven. Wipe it up with a damp cloth after the oven cools.
- If white spots remain, remove them with a soap-filled scouring pad and rinse thoroughly with a vinegar and water mixture.
- These deposits are usually a salt residue that cannot be removed by the clean cycle.
- If the oven is not clean after one clean cycle, repeat the cycle.
- You cannot set the oven for cooking until the oven is cool enough for the door to unlock.
- While the oven is self-cleaning, you can press the **CLOCK** pad to display the time of day. To return to the clean countdown, press the **COOK TIME** pad.
- If the racks become hard to slide, apply a small amount of vegetable oil or cooking oil to a paper towel and wipe the edges of the oven racks with the paper towel.

CARE AND CLEANING OF THE RANGE

CARE AND CLEANING

Make sure electrical power is off and all surfaces are cool before cleaning any part of the range.



If your range is pulled away from the wall for cleaning, servicing or any reason, ensure that the anti-tip device is re-engaged properly when the range is pushed back against the wall.



Failure to take this precaution could result in tipping of the range and cause injury.

⚠ CAUTION:

- **DO NOT** remove any parts from the cooktop until they have completely cooled and are safe to handle.
- **DO NOT** operate the surface burners without all burner parts and grates in place.

The electrode of the spark igniter is exposed when the burner head is removed. When turning a burner to “**LITE**”, all the burners spark. Do not attempt to disassemble or clean around any burner while another burner is on. An electric shock may result.

SEALED BURNER ASSEMBLIES

Turn all controls OFF before removing the burner parts. The burner grates, caps, and burner heads can be lifted off, making them easy to clean. The electrodes are not removable.

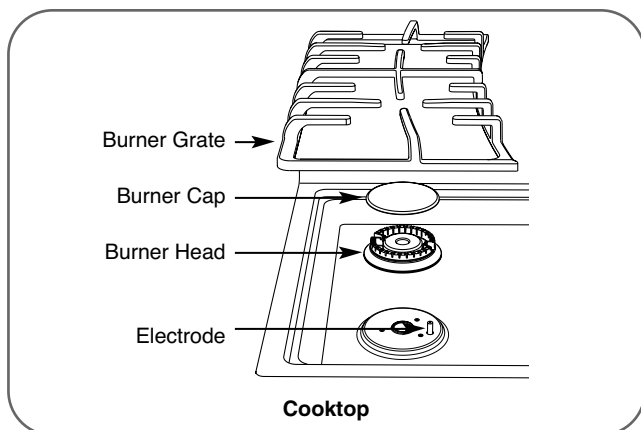

OVAL BURNER ASSEMBLY

The oval burner assembly can be lifted off, making it easy to clean. The burner electrode is not removable.

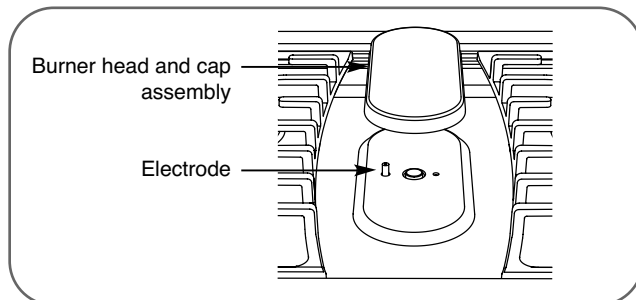

CARE AND CLEANING OF THE RANGE

BURNER CAPS AND HEADS

- **DO NOT** use bleach on product to clean.

BURNER CAPS

Lift off when cool. Wash burner caps in hot, soapy water and rinse with clean water. To remove burned on food particles, you may scour with a plastic scouring pad.

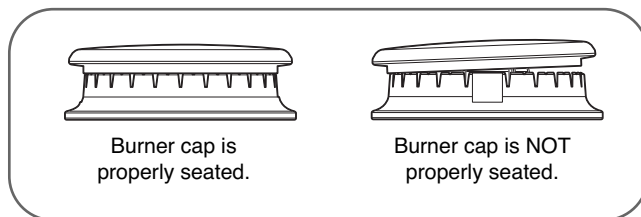

BURNER HEADS AND OVAL (CENTER) BURNER HEAD/CAP ASSEMBLY

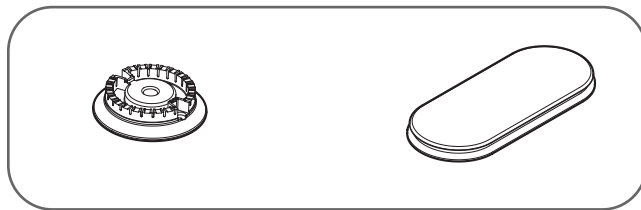

The burner heads and the oval burner head/cap assembly are removable. Simply lift them off the range for cleaning. For even and unhampered flame, the slits in the burner heads must be kept clean at all times. Clogged or dirty burner ports or electrodes will not allow the burner to operate properly. Any spill on or around an electrode must be carefully cleaned. Take care to not hit an electrode with anything hard or it could be damaged.

You should clean the burner caps and heads routinely, especially after bad spillovers which could clog the openings. Lift them off when they are cool.

If you want to remove burned-on food, soak the burner heads in a solution of mild liquid detergent and hot water for 20–30 minutes. For more stubborn stains, use a toothbrush.

NOTES:

- **DO NOT** use steel wool or scouring powders to clean the burners.
- Burners will not light if the cap is removed.

AFTER CLEANING

Before replacing the burner caps and burner heads shake out excess water and then dry them thoroughly.

REPLACEMENT

Replace burner heads and caps over the electrodes on the cooktop, in the correct locations according to their size.

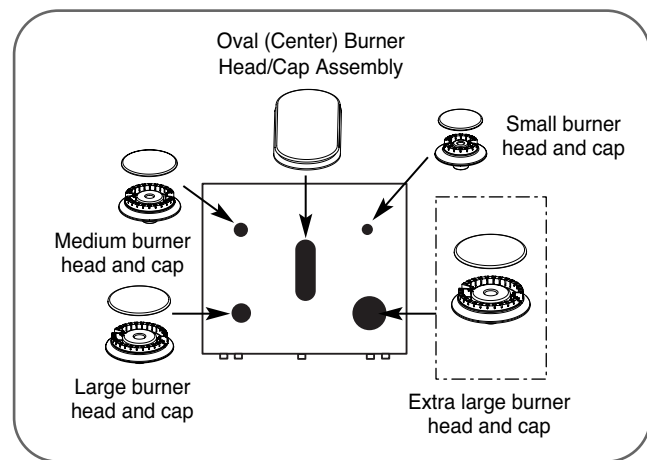

Make sure the hole in the burner head is positioned over the electrode.

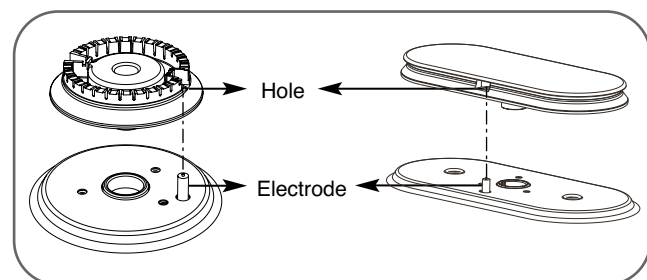

CARE AND CLEANING OF THE RANGE

BURNER GRATES

Your range has three professional-style grates.

For maximum stability, these grates should only be used in their proper position; Two side grates can be interchanged left to right and front to back. Center grate can be also interchanged front to back.

DO NOT operate a burner for an extended period of time without cookware on the grate. The finish on the grate may chip without cookware to absorb the heat.

Although they are durable, the grates will gradually lose their shine, regardless of the best care you can give them.

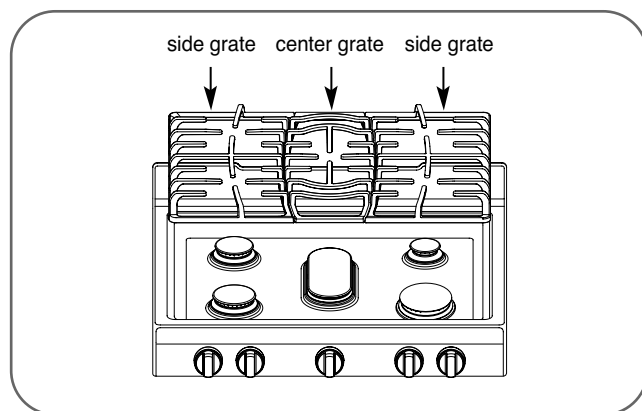

CLEANING

Lift the grates out when they have cooled. They should be washed regularly and, of course, after spillovers. Wash them in hot, soapy water and rinse with clean water. When replacing the grates, be sure they are positioned securely over the burners. Replace the grates so that continuous arcs are formed with the center ribs of all three grates. The grates are dishwasher safe.

NOTE: DO NOT clean the grates in a self-cleaning oven.

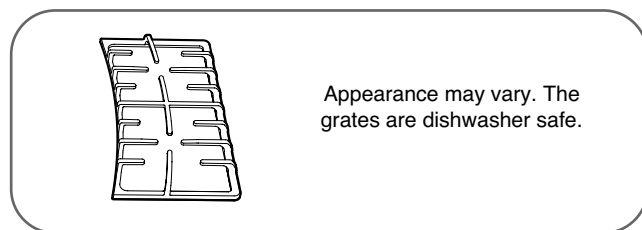

Appearance may vary. The grates are dishwasher safe.

COOKTOP SURFACE

To avoid damaging the porcelain enamel surface of the cooktop and to prevent it from becoming dull, clean up spills right away. Foods with a lot of acid such as tomatoes, sauerkraut, fruit juices, etc. or foods with high sugar content could cause a dull spot if allowed to set. Wash and rinse when the surface has cooled.

For other spills such as fat splatterings, etc., wash with soap and water once the surface has cooled. Then rinse and polish with a dry cloth.

NOTE: DO NOT lift the cooktop. Lifting the cooktop can lead to damage and improper operation of the range.

CARE AND CLEANING OF THE RANGE

STAINLESS STEEL SURFACES

DO NOT use a steel wool pad; it will scratch the surface.

To clean the stainless steel surface, use warm sudsy water or a stainless steel cleaner or polish. Always wipe the surface in the direction of the grain. Follow the cleaner instructions for cleaning the stainless steel surface.

To inquire about purchasing stainless steel appliance cleaner or polish, or to find the location of a dealer nearest you, please call our toll-free customer service number:

1-800-243-0000

or visit our website at:
us.lgservice.com

OVEN AIR VENTS

DO NOT block the vents and air openings of the range. They provide the air inlet and outlet that are necessary for the range to operate properly with correct combustion.

Air openings are located at the rear of the cooktop, at the top and bottom of the oven door, and at the bottom of the range, under the warming drawer.

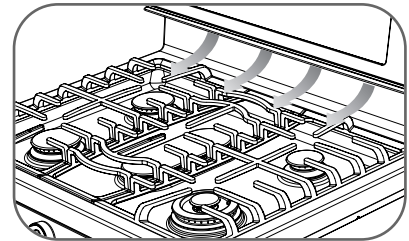

CONTROL PANEL

Clean up splatters with a damp cloth.

You may also use a glass cleaner.

Remove heavier soil with warm soapy water.

Do not use abrasives of any kind.

NOTE: To prevent activating the control panel during cleaning, unplug the range.

FRONT MANIFOLD PANEL AND KNOBS

It's better to clean the manifold panel after each use of the oven. Use a damp cloth to clean or rinse. For cleaning, use mild soap and water or a 50/50 solution of vinegar and water. For rinsing, use clean water. Polish dry with a soft cloth.

DO NOT use abrasive cleansers, strong liquid cleaners, plastic scouring pads or oven cleaners on the manifold panel—they will damage the finish.

DO NOT try to bend knobs by pulling them up or down or by hanging a towel or other such loads. This can damage the gas valve shaft.

The control knobs may be removed for easier cleaning.

Make sure the knobs are in the “OFF” positions and pull them straight off the stems for cleaning.

To replace the knobs, make sure the knob has the “OFF” position centered at the top and slide the knob directly onto the stem.

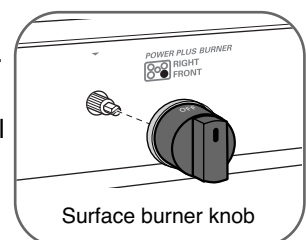

CARE AND CLEANING OF THE RANGE

OVEN DOOR

The oven door is removable, but it is heavy. You may need help removing and replacing the door.

⚠ CAUTION:

- Be careful when removing and lifting the door.
- DO NOT lift the door by the handle.
- The door is very heavy.

TO REMOVE THE DOOR

Step. 1

Open the door fully.

Step. 2

Pull the hinge locks down toward the door frame to the unlocked position.

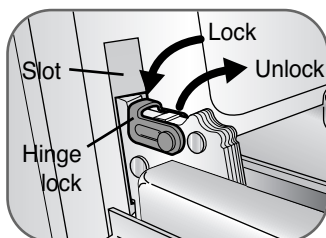

Step. 3

Firmly grasp both sides of the door at the top.

Step. 4

Close door to the door removal position, which is approximately 5 degrees.

Step. 5

Lift door up and out until the hinge arm is clear of the slot.

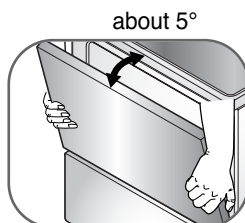

TO CLEAN THE INSIDE OF THE DOOR

- DO NOT allow excess water to run into any holes or slots in the door.
- Because the area inside the gasket in front of the cavity is cleaned during the self clean cycle, you do not need to clean this by hand.
- The area outside the gasket can be cleaned with a soap-filled plastic scouring pad.

TO REPLACE THE DOOR

Step. 1

Firmly grasp both sides of the door at the top.

Step. 2

With the door at the same angle as the removal position, seat the indentation of the hinge arm into the bottom edge of the hinge slot. The notch in the hinge arm must be fully seated into the bottom of the slot.

Step. 3

Open the door fully. If the door will not open fully, the indentation is not seated correctly in the bottom edge of the slot.

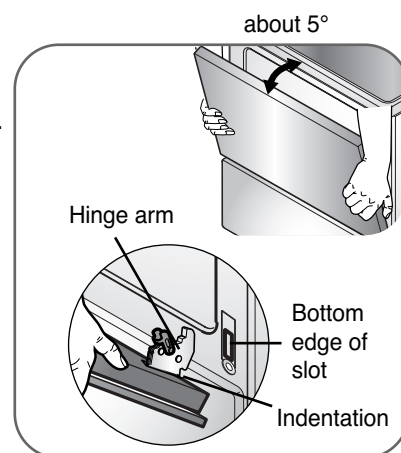

Step. 4

Push the hinge locks up against the front frame of the oven cavity to the locked position.

Step. 5

Close the oven door.

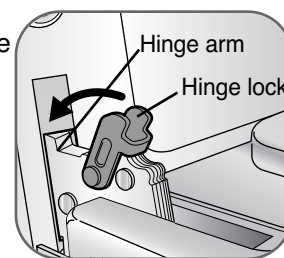

TO CLEAN THE OUTSIDE OF THE DOOR

- Use soap and water to thoroughly clean the top, sides and front of the oven door. Rinse well. You may also use a glass cleaner to clean the glass on the outside of the door.
- Spillage of marinades, fruit juices, tomato sauces and basting materials containing acids may cause discoloration and should be wiped up immediately. When the surface is cool, clean and rinse.
- DO NOT use oven cleaners, cleansing powders or harsh abrasives on the outside of the door.

CARE AND CLEANING OF THE RANGE

OVEN BOTTOM

The oven bottom has a porcelain enamel finish. To make cleaning easier, protect the oven bottom from excessive spillovers by placing a cookie sheet on the rack below the rack you are cooking on. This is especially important when baking a fruit pie or other foods with a high acid content. Hot fruit fillings or other foods with a lot of acid (tomatoes, sauerkraut, sauces with vinegar or lemon juice) may cause pitting and damage to the porcelain enamel surface and should be wiped up right away.

DO NOT use aluminum foil on the bottom of the range. It can damage the oven cavity and block the air flow of the burner causing poor heat distribution.

To clean up spillovers, use soap and water, an abrasive cleaner or soap-filled scouring pad. Rinse well to remove any soap before self-cleaning.

BROILER PAN AND GRID

After broiling, remove the broiler pan from the oven. Remove the grid from the pan. Carefully pour out grease from the pan into a proper container. Wash and rinse the broiler pan and grid in hot water with a soap-filled or plastic scouring pad.

If food has been burned on the broiler pan or grid, spray the pan and grid with a detergent and let them soak. Use a paper towel or wash rag with warm water to clean.

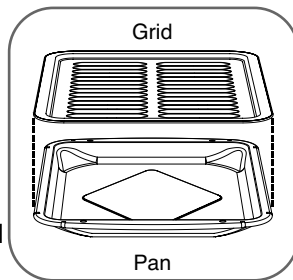

NOTES:

- The broiler pan and grid may be cleaned with a commercial oven cleaner.
- Both the broiler pan and grid are dishwasher safe.
- **DO NOT** store a soiled broiler pan and grid anywhere in the range.
- **DO NOT** clean the broiler pan or grid in a self-cleaning oven.

CARE AND CLEANING OF THE RANGE

OVEN RACKS

Your oven is equipped with nickel oven racks, remove them from the oven before beginning the self-clean cycle.

To clean the oven racks, use an abrasive cleanser. After cleaning, rinse the racks with clean water and dry with a clean cloth. If the racks ever become hard to slide, wipe the rack edges or oven rack supports with vegetable oil.

OVEN LIGHT REPLACEMENT

The oven light is a standard 40-watt appliance bulb. It will come on when the oven door is open. When the oven door is closed, touch OVEN LIGHT to turn ON or OFF. It will not work during the Self-Clean cycle.

⚠ WARNING:

- Before replacing your oven light bulb, **DISCONNECT the electrical power to the range at the main fuse or circuit breaker panel.**
 - Failure to do so can result in severe personal injury, death or electrical shock.
- **Make sure oven and bulb are cool completely.**

TO REPLACE

- Make sure oven and bulb are cool.
- ➊ Unplug range or disconnect power.
- ➋ Turn the glass bulb cover in the back of the oven counterclockwise to remove.
- ➌ Turn bulb counterclockwise to remove from socket.
- ➍ Replace bulb and bulb cover by turning clockwise.
- ➎ Plug in range or reconnect power.

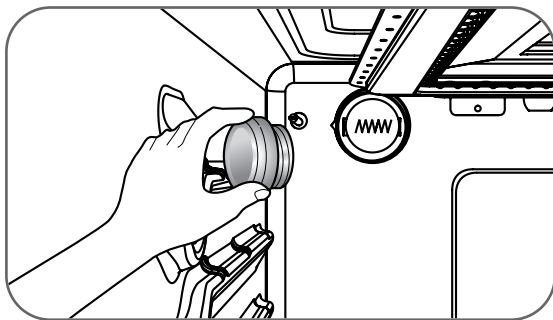

CARE AND CLEANING OF THE RANGE

REMOVING & REPLACING THE STORAGE DRAWER

To Remove Storage Drawer:

- 1 **CAUTION** - Turn power OFF before removing the storage drawer.
- 2 Pull the drawer out until it stops.
- 3 Lift the front of the drawer until the stops clear the guides.
- 4 Remove the drawer.

⚠ WARNING

- Turn **POWER OFF** before removing the Warming Drawer.
- Failure to do so can result in severe personal injury, death, or electrical shock.

To Replace the Storage Drawer:

- 1 Place the drawer rails on the guides.
- 2 Push the drawer back until it stops.
- 3 Lift the front of the drawer and push back until the stops clear the guides.
- 4 Lower the front of the drawer and push back until it closes.

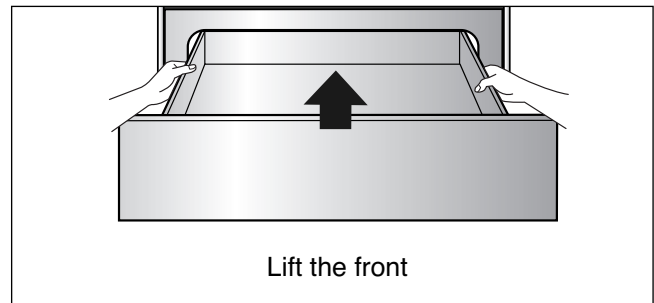
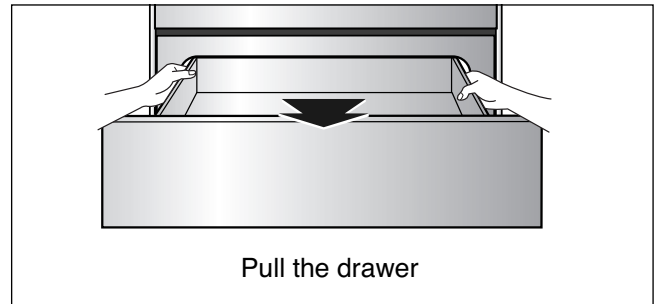

BEFORE CALLING FOR SERVICE

Before you call for service, review this list. It may save you time and expense. This list includes common occurrences that are not the result of a defect in workmanship or materials.

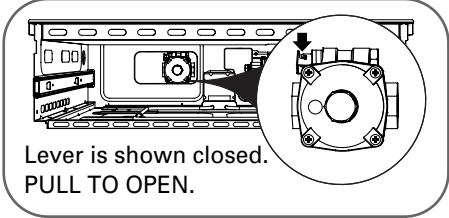
Problem	Possible Causes	Solutions
Top burners do not light or do not burn evenly	<ul style="list-style-type: none"> • The plug on range is not completely inserted in the electrical outlet. • Burner slits on the side of the burner may be clogged. • Improper burner assembly. 	<ul style="list-style-type: none"> • Make sure the electrical plug is inserted into a live, properly grounded outlet. • Remove the burners and clean them. Check the electrode area for burned-on food or grease. See the "CARE AND CLEANING OF THE RANGE" section. • Make sure the burner parts are installed correctly. See the "CARE AND CLEANING OF THE RANGE" section.
Burner flames very large or yellow	<ul style="list-style-type: none"> • Improper air to gas proportion. 	<ul style="list-style-type: none"> • If range is connected to LP gas, contact the technician who installed your range or made the conversion.
Surface burners light but the oven does not	<ul style="list-style-type: none"> • The oven gas shut-off valve may have accidentally been moved during cleaning or moving. 	<ul style="list-style-type: none"> • To check the oven gas shut-off valve, remove the warming drawer (see the "CARE AND CLEANING OF THE RANGE" section) and look for the gas shut-off lever at the back of the range.  <p>Lever is shown closed. PULL TO OPEN.</p>
Food does not bake or roast properly	<ul style="list-style-type: none"> • Improper oven controls setting. • Incorrect rack position. • Incorrect cookware or cookware of improper size being used. • Oven thermostat needs adjustment. • Clock not set correctly. • Aluminum foil used improperly in the oven. 	<ul style="list-style-type: none"> • See the "USING THE OVEN" section. • See the "USING THE OVEN" section. • See the "USING THE OVEN" section. • See the "HOW TO ADJUST THE OVEN THERMOSTAT" section. • See the "USING THE CLOCK AND TIMER" section. • See the "CARE AND CLEANING OF THE RANGE" section.

TROUBLESHOOTING

BEFORE CALLING FOR SERVICE

Problem	Possible Causes	Solutions
Food does not broil properly in the oven	<ul style="list-style-type: none"> • Improper oven controls setting. • Oven door not closed. • Incorrect rack position. • Food being cooked in a hot pan. • Cookware not suited for broiling. • Aluminum foil used on the broiling pan and grid has not been fitted properly and slit as recommended. 	<ul style="list-style-type: none"> • Make sure you press the "BROIL HI/LO" pad. • See the "USING THE OVEN" section. • See the "BROILING GUIDE". • Use the broiling pan and grid that came with your range. Make sure it is cool. • Use the broiling pan and grid that came with your range. • See the "USING THE OVEN" section.
Oven temperature too hot or too cold	<ul style="list-style-type: none"> • Oven thermostat needs adjustment. 	<ul style="list-style-type: none"> • See the "HOW TO ADJUST THE OVEN THERMOSTAT" section.
Clock and timer does not work	<ul style="list-style-type: none"> • The plug on range is not completely inserted in the electrical outlet. • A fuse in your home may be blown or the circuit breaker tripped. • Improper oven controls setting. 	<ul style="list-style-type: none"> • Make sure the electrical plug is inserted into a live, properly grounded outlet. • Replace the fuse or reset the circuit breaker. • See the "USING THE CLOCK AND TIMER" section.
Oven light does not work	<ul style="list-style-type: none"> • The light bulb is loose or defective. • The plug on range is not completely inserted in the electrical outlet. 	<ul style="list-style-type: none"> • Tighten or replace the bulb. • Make sure the electrical plug is inserted into a live, properly grounded outlet.
Oven will not self-clean	<ul style="list-style-type: none"> • The oven temperature is too high to set a self-clean operation. • Improper oven controls setting. 	<ul style="list-style-type: none"> • Allow the range to cool to room temperature and reset the controls. • See the "USING THE SELF-CLEANING OVEN" section.
"Crackling" or "popping" sound	<ul style="list-style-type: none"> • This is the sound of the metal heating and cooling during both the cooking and cleaning functions. 	<ul style="list-style-type: none"> • This is normal.
Too much smoking during a self clean cycle.	<ul style="list-style-type: none"> • Too much soil. 	<ul style="list-style-type: none"> • Press the "CLEAR OFF" pad. Open the windows to get rid of smoke from the room. Wait until the DOOR LOCKED light goes off. Wipe up the excess soil and reset the clean cycle.

BEFORE CALLING FOR SERVICE

Problem	Possible Causes	Solutions
Broil or self-clean doesn't work	<ul style="list-style-type: none"> The oven temperature is too high. 	<ul style="list-style-type: none"> Allow the oven to cool below locking temperature. This can take up to 1 hr after the cycle is complete.
Oven not clean after a self-clean cycle	<ul style="list-style-type: none"> Improper oven controls setting. The oven was heavily soiled. 	<ul style="list-style-type: none"> See the Using the "USING THE SELF-CLEANING OVEN" section. Clean up heavy spillovers before beginning the self-clean cycle. Heavily soiled ovens may need to self-clean again or for a longer period of time.
"CLOSE DOOR TO CONTINUE BROILING" or "DOOR OPENED" appears in the display	<ul style="list-style-type: none"> The broil or self-clean cycle has been selected but the door is not closed. 	<ul style="list-style-type: none"> Close the oven door.
"DOOR LOCKED" light is on when you want to cook	<ul style="list-style-type: none"> The oven door is locked because the temperature inside the oven has not dropped below the locking temperature. 	<ul style="list-style-type: none"> Touch the "CLEAR OFF" pad. Allow the oven to cool.
Oven control beeps and displays any F code error.	<ul style="list-style-type: none"> You have "F3". You have "F11". If the function code repeats. 	<ul style="list-style-type: none"> Touch the "CLEAR OFF" pad. Allow the oven to cool for one hour. Put the oven back into operation. Check the main gas shut-off valve or the oven gas shut-off valve(see "Surface burners light but oven burner does not" column). Disconnect all power to the range for 5 minutes and then reconnect power. If the function error code repeats, call for service.
Oven racks are difficult to slide	<ul style="list-style-type: none"> The oven racks were cleaned in a self-clean cycle. 	<ul style="list-style-type: none"> Apply a small amount of vegetable oil to a paper towel and wipe the edges of the oven racks with the paper towel. Do not use lubricant sprays.
Power outage, clock flashes	<ul style="list-style-type: none"> Power outage or surge. 	<ul style="list-style-type: none"> Reset the clock. If the oven was in use, you must reset it by touching the "CLEAR OFF" pad, setting the clock and resetting any cooking function.
"Burning" or "oily" odor emitting from the vent	<ul style="list-style-type: none"> This is normal in a new oven and will disappear in time. 	<ul style="list-style-type: none"> To speed the process, set a self-clean cycle for a minimum of 3 hours. See the "USING THE SELF-CLEANING OVEN" section.
Strong odor	<ul style="list-style-type: none"> An odor from the insulation around the inside of the oven is normal for the first few times the oven is used. 	<ul style="list-style-type: none"> This is temporary.

TROUBLESHOOTING

BEFORE CALLING FOR SERVICE

Problem	Possible Causes	Solutions
Drawer does not slide smoothly or drags	<ul style="list-style-type: none">• The drawer is out of alignment.• Drawer is over-loaded or load is unbalanced.	<ul style="list-style-type: none">• Fully extend the drawer and push it all the way in. See the <i>Care and Cleaning of the Range</i> section.• Reduce weight. Redistribute drawer contents.
Warming drawer will not work	<ul style="list-style-type: none">• A fuse in your home may be blown or the circuit breaker tripped.• The oven is self-cleaning.• Controls improperly set.	<ul style="list-style-type: none">• Replace the fuse or reset the circuit breaker.• Wait for the self-clean cycle to finish and the oven to cool.• See the <i>Using the Electric Warming Drawer</i> section.
Excessive condensation in the drawer	<ul style="list-style-type: none">• Liquid in drawer.• Uncovered foods.• Temperature setting too high.	<ul style="list-style-type: none">• Remove liquid.• Cover food with lid or aluminum foil.• Reduce temperature setting.
Food dries out in warming drawer	<ul style="list-style-type: none">• Moisture escaping.• Drawer not fully closed.	<ul style="list-style-type: none">• Cover food with lid or aluminum foil.• Push drawer in until latch engages.

LG GAS RANGE LIMITED WARRANTY – USA

LG Electronics Inc. will repair or replace your product, at LG's option, if it proves to be defective in material or workmanship under normal use, during the warranty period set forth below, effective from the date of original consumer purchase of the product. This limited warranty is good only to the original purchaser of the product and effective only when used in U.S.A.

WARRANTY PERIOD:	HOW SERVICE IS HANDLED:
One Year From the date of the original purchase	Any part of the oven which fails due to a defect in materials or workmanship. During this full one-year warranty , LG will also provide, free of charge , all labour and in-home service to replace the defective part.

THIS WARRANTY IS IN LIEU OF ANY OTHER WARRANTIES, EXPRESS OR IMPLIED, INCLUDING WITHOUT LIMITATION, ANY WARRANTY OF MERCHANTABILITY OR FITNESS FOR A PARTICULAR PURPOSE. TO THE EXTENT ANY IMPLIED WARRANTY IS REQUIRED BY LAW, IT IS LIMITED IN DURATION TO THE EXPRESS WARRANTY PERIOD ABOVE. LG WILL NOT BE LIABLE FOR ANY CONSEQUENTIAL, INDIRECT, OR INCIDENTAL DAMAGES OF ANY KIND, INCLUDING LOST REVENUES OR PROFITS, IN CONNECTION WITH THE PRODUCT. SOME STATES DO NOT ALLOW LIMITATION ON HOW LONG AN IMPLIED WARRANTY LASTS OR THE EXCLUSION OF INCIDENTAL OR CONSEQUENTIAL DAMAGES, SO THE ABOVE LIMITATIONS OR EXCLUSIONS MAY NOT APPLY TO YOU.

THIS LIMITED WARRANTY DOES NOT APPLY TO:

1. Service calls to correct the installation of your appliance, to instruct you how to use your appliance, to replace house fuses or correct house wiring, or to replace owner-accessible light bulbs.
2. Repairs when your appliance is used in other than normal, single-family household use.
3. Pickup and delivery. Your appliance is designed to be repairable in the home.
4. Damage resulting from accident, alteration, misuse, abuse, fire, flood, improper installation, acts of God, or use of products not approved by LG Corporation.
5. Repairs to parts or systems resulting from unauthorized modifications made to the appliance.
6. Replacement parts or repair labour costs for units operated outside the united states.
7. Any labour costs during the limited warranty period.

This warranty is extended to the original purchaser for products purchased for home use within the USA. In Alaska, the warranty excludes the cost of shipping or service calls to your home. Some states do not allow the exclusion or limitation of incidental or consequential damages, so this exclusion or limitation may not apply to you. This warranty gives you specific legal rights, and you may also have other rights which vary from states to states. To know what your legal rights are, consult your local or state consumer affairs or your state's Attorney General.

CUSTOMER ASSISTANCE INFORMATION:

To Prove Warranty Coverage	Retain your Sales Receipt to prove date of purchase. A copy of your Sales Receipt must be submitted at the time warranty service is provided.
To Obtain Nearest Authorized Service Center or Sales Dealer, or to Obtain Product, Customer, or Service Assistance	Call 1-800-243-0000 (Phone answered 24 hours - 365 days a year) and choose the appropriate prompt from the menu; or visit our website at: http://us.lgservice.com .

Memo
