

This Owner's Manual is provided and hosted by Appliance Factory Parts.



LG LRG3093SW Owner's Manual

[Shop genuine replacement parts for LG LRG3093SW](#)

INTRODUCTION (II)

For Model: LRG3093SB
LRG3093SW

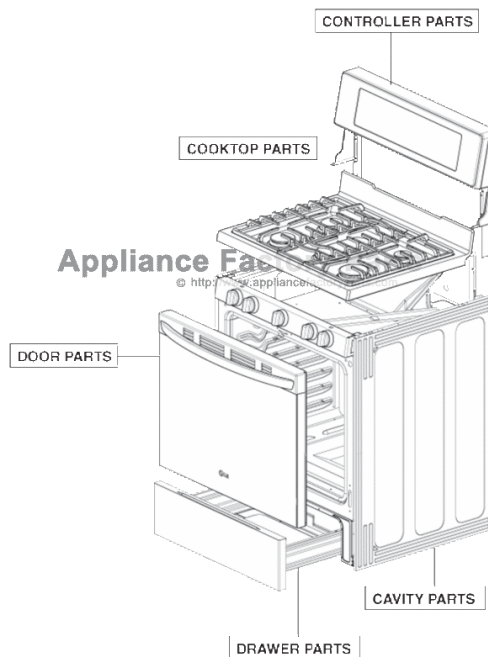

[Find Your LG Gas Range Parts - Select From 55 Models](#)

----- Manual continues below -----



Internal Use Only

Website <http://us.lgservice.com>

30" Freestanding Gas Range

SERVICE MANUAL

MODEL: LRG3093ST
LRG3093SB
LRG3093SW

CAUTION

BEFORE SERVICING THE UNIT, READ THE SAFETY PRECAUTIONS IN THIS MANUAL.

P/NO : MFL63290102

December, 2009
Printed in Korea

FORWARD

This LG Service Manual, “30” Freestanding Self-Cleaning Gas Range,” provides the technician with information on the operation and service of the Freestanding Self-Cleaning Gas Range. It is to be used as a training Service Manual. For specific information on the model being serviced, refer to the “Owner’s Manual” or “Tech Sheet” provided with the gas range.

SAFETY PRECAUTIONS

- Repairs of the appliance should be carried out by a licensed technician only. Incorrect repairs may result in dangerous situations. If you need repairs, contact an LG Service Center or your dealer.
- If the power cord is defective, it must be replaced by a qualified service agent with a UL listed range cord.
- Electrical leads and cables should not be allowed to touch the oven.
- Rating plate is located on the left side of warming drawer.
- The power supply of the appliance should be turned off when it is being repaired.

WARNING

If the information in this manual is not followed exactly, a fire or explosion may result causing property damage, personal injury or death. If you smell gas:

- **Do not try to light any appliance.**
- **Do not touch any electrical switch; do not use any phone in your building.**
- **Immediately call your gas supplier from a neighbor’s phone. Follow the gas supplier’s instructions.**
- **If you cannot reach your gas supplier, call the fire department.**

WARNING

- **DISCONNECT power supply cord from the outlet before servicing.**
- **Replace all panels and parts before operating.**
- **RECONNECT all grounding devices.**
 - Failure to do so can result in severe personal injury, death or electrical shock.
- **DO NOT Touch when the oven operates.**
 - The interior parts will be very hot.

LG Electronics assumes no responsibility for any repairs made on our products by anyone other than Authorized Service Technicians.

TABLE OF CONTENTS

(PAGE)

GENERAL	1-1 ~ 1-5
• Important safety instructions	1-1 ~ 1-3
• Model & Serial number label and tech sheet locations	1-4
• Specifications	1-5
USING YOUR RANGE	2-1 ~ 2-4
• General information	2-1
• Control panel features	2-2 ~ 2-4
- To turn on on the surface burners	
- Setting the Clock	
- Start, Clean/Off	
- To turn On/Off the oven light	
- Timer On/Off	
- Warm(Options: Hold 3 sec) pad: (6 types of category).	
- Bake, Timed Bake, Delayed timed Bake	
- Broil	
- Warm	
- Time cook with warm	
- Oven lockout	
- Changing hour mode on clock (12HR, 24HR)	
- Proof	
- Self-Clean	
COMPONENT ACCESS	3-1 ~ 3-20
• Component Locations	3-1
• Removing the Back, Control cover and Key pad assembly	3-2
• Removing the Spark Module(IG Trans) and Power Control Board (PCB)	3-3
• Removing the Cooktop Plate	3-4
• Removing the Case assembly(Cooktop Burner assembly)	3-5
• Removing the Cooktop Parts	3-6~3-7
• Removing the Door Latch and the Door Switch	3-8
• Removing the BROIL Burner assembly	3-9
• Oven Bottom, the Frame guide and the Burner assembly	3-10
• Removing the Oven light & Socket assembly	3-11
• Removing the latch drive assembly	3-12
- Door locking mechanism	3-12
• Removing the Oven temperature Sensor	3-13
• Removing & Replacing the Warming drawer	3-14
• Removing & Replacing the Lift-off Oven Door	3-15
• Removing the Oven Door Handle & Glass	3-16 ~ 3-17
• Removing the Oven Door Gasket	3-18
• Removing a Side Panel	3-19
• Removing the Oven Valve (Safety Valve) & Gas Regulator	3-20

COMPONENT TEST	4-1 ~ 4-3
• Door locking Motor	4-1
• Micro Switch (normally open type)	4-2
• Oven Sensor	4-2
• Door switch	4-2
• Oven lamp	4-3
• Broil or bake igniter	4-3
• Oven (safety) valve	4-3
• Ignition switch	4-3
CONVERSION TO LP GAS	5-1 ~ 5-5
COMPOSITION OF CONTROL	6-1 ~ 6-2
• Main PCB	6-2
• Power PCB	6-2
• Relay PCB	6-2
DIAGNOSIS THROUGH SCHEMATIC	7-1
CHECK THE FAILURE CODE (F-code)	8-1
FAILURE CODE SUMMARY	9-1
CHECKING FLOW CHART BY FAILURE	10-1 ~ 10-15
• Power Failed(Dead), No display?	10-2 ~ 10-3
• Oven does not heat, F-11	10-5 ~ 10-6
• Door Lock System Failure, F-10?	10-8
• Sensing Fail, F-1, F-2?	10-10
• Oven too hot, F-6, F-16?	10-12 ~ 10-13
• F-3 error (Touch-sensor key error) Or Key does not input	10-15
TROUBLE SHOOTING	11-1 ~ 11-4
EXPLODED VIEW	12-1 ~ 12-9
REPLACEMENT PARTS LIST	13-1 ~ 13-12

GENERAL

IMPORTANT SAFETY INSTRUCTIONS

Read and follow all instructions before using your oven to prevent the risk of fire, electric shock, injury to person, or damage when using the range. This guide don't cover all possible conditions that may occur. For further assistance contact your service agent or manufacturer.



This is the safety alert symbol. This symbol alerts you to potential hazards that can kill or hurt you and others. All safety messages will follow the safety alert symbol and either the word "WARNING" or "CAUTION". These word means :



WARNING

This symbol will alert you to hazards or unsafe practices which could cause serious bodily harm or death.



CAUTION

This symbol will alert you to hazards or unsafe practices which could cause bodily injury or property damage.



WARNING

- **DO NOT step or sit on the door and install the Anti-Tip Bracket packed with range.**
 - The range could be tipped and injury might result from spilled hot liquid, food, or the range itself.
 - If the range is pulled away from the wall for cleaning, service, or any other reason, ensure that the Anti-Tip Device is properly reengaged when the range is pushed back against the wall.
- **DISCONNECT power supply cord from the outlet before servicing.**
- **Replace all panels and parts before operating.**
- **RECONNECT all grounding devices.**
 - Failure to do so can result in severe personal injury, death or electrical shock.
- **DO NOT touch burners, grates or interior surfaces of oven.**
 - Heating element may be hot even though they are off.
 - Interior surfaces of an oven become hot enough to cause burns.
- **During and after use, do not touch, or let clothing or other flammable materials contact burners, grates or interior surfaces of oven until they have had sufficient time to cool.**
 - Other surfaces of the appliance may become hot enough to cause burns among these surfaces are oven vent openings and surfaces near these openings, oven doors, and windows of oven doors.
- **DO NOT store items of interest to children in cabinets above a range or on the back guard of a range.**
 - Children climbing on the range to reach items could be seriously injured.



CAUTION

- **Always use Pot Holders or oven mitts when removing food from the Warming Drawer.**
 - You can be burned as cookware and plates will be hot.
- **Be careful when you work on the gas range handling the sheet metal part.**
 - Sharp edge may be present and you can cut yourself.
- **Be careful not to bend the fan blade**
 - Failure to do so can result in vibration, noise, and poor performance of convection when operating.
- **Be careful not to scratch or chip the oven liner paint when you remove the oven light socket in the next step.**
- **Turn power OFF before removing the Warming Drawer.**
- **Be careful when removing and lifting the door.**
- **DO NOT lift the door by the handle.**
 - Failure to do so can result in personal injury as the door is very heavy.

GENERAL

IMPORTANT SAFETY INSTRUCTIONS

- Be sure your appliance is properly installed and grounded by a qualified technician.
- Do not repair or replace any part of the appliance unless specifically recommended in the manual.
All other servicing should be referred to a qualified technician.
- Always disconnect power to appliance before servicing by removing the fuse or switching off the circuit breaker

WARNING



- **ALL RANGES CAN TIP**
- **INJURY TO PERSONS COULD RESULT**
- **INSTALL ANTI-TIP DEVICES PACKED WITH RANGE**
- **SEE INSTALLATION**



- **DO NOT step or sit on the door and install the Anti-Tip Bracket packed with range.**
 - The range could be tipped and injury might result from spilled hot liquid, food, or the range itself.
 - If the range is pulled away from the wall for cleaning, service, or any other reason, ensure that the Anti-Tip Device is properly reengaged when the range is pushed back against the wall.

To reduce the risk of tipping of the range, the range must be secured by properly installed anti-tip devices. To check if the bracket is installed properly.

- **Warming drawer** : grasp the top rear edge of the Range and carefully attempt to tilt it forward.
Verify that the anti-tip devices are engaged.
 - **Storage drawer** : Remove drawer and verify leveling leg is inserted into and fully secured by the anti-tip devices.
- Refer to the installation manual for proper anti-tip bracket installation.

WARNING

- **DO NOT touch burners, grates or interior surfaces of oven.**
 - Burners, grates may be hot even though they are off.
 - Interior surfaces of an oven become hot enough to cause burns.
- **During and after use, do not touch, or let clothing or other flammable materials contact burners, grates or interior surfaces of oven until they have had sufficient time to cool.**
 - Other surfaces of the appliance may become hot enough to cause burns among these surfaces are oven vent openings and surfaces near these openings, oven doors, and windows of oven doors.

WARNING

- **DO NOT store items of interest to children in cabinets above a range or on the back guard of a range.**
 - Children climbing on the range to reach items could be seriously injured.

- **Do Not Leave Children Alone** - Children should not be left alone or unattended in area where appliance is in use. They should never be allowed to sit or stand on any part of the appliance.
- **Never Use Your Appliance for Warming or Heating the Room.**
- **Storage in or on Appliance** – Flammable materials should not be stored in an oven or near surface units. Be sure all packing materials are removed from the appliance before operating it. Keep plastics, clothes and paper away from parts of the appliance that may become hot
- **Wear Proper Apparel** – Loose-fitting or hanging garments should never be worn while using the appliance.
- **Do Not Use Water on Grease Fires** – Turn off oven to avoid spreading the flame. Smother the fire or flame by closing the door or use dry chemical, baking soda or foam-type extinguisher.
- Make sure your range is properly adjusted by a qualified service technician or installer for the type of gas (natural or LP) that is to be used. Your range can be converted for use with either type of gas.
- **NEVER** block the vents (air holes) of the range. They provide the air inlet and outlet that are necessary for the range to operate properly with correct combustion. Air openings are located at the rear of the cooktop, at the top and bottom of the oven door, and at the bottom of the range under the warming drawer.

WARNING

- **DISCONNECT power supply cord from the outlet before servicing.**
- **Replace all panels and parts before operating.**
- **RECONNECT all grounding devices.**
 - Failure to do so can result in severe personal injury, death or electrical shock.

GENERAL

IMPORTANT SAFETY INSTRUCTIONS

SURFACE COOKING UNITS

- If the top burner flame goes out, gas is still flowing to the burner until the knob is turned to the "OFF" position. Do not leave the burners "ON" unattended.
- **Use Proper Pan Size** – This appliance is equipped with one or more surface units of different sizes. Select utensils having flat bottoms large enough to cover the surface unit heating element. The use of undersized utensils will expose a portion of the heating element to direct contact and may result in ignition of clothing. Proper relationship of utensil to burner will also improve efficiency.
- **Never Leave Surface Units Unattended at High Heat Settings** – Boil overs may cause smoking and greasy spillovers may ignite.
- **Make Sure Reflector Pans or Drip Bowls Are in Place** – Absence of these pans or bowls during cooking may subject wiring or components underneath to damage.
- **Protective Liners** – Do not use aluminum foil to line surface unit drip bowls or oven bottoms, except as suggested in the manual. Improper installation of these liners may result in a risk of electric shock, or fire.
- **Glazed Cooking Utensils** – Only certain types of glass, glass/ceramic, ceramic, earthenware, or other glazed utensils are suitable for range-top service without breaking due to the sudden change in temperature.
- **Utensil Handles Should Be Turned Inward and Not Extend Over Adjacent Surface Units** – To reduce the risk of burns, ignition of flammable materials, and spillage due to unintentional contact with the utensil, the handle of a utensil should be positioned so that it is turned inward, and does not extend over adjacent surface units.
- Be sure you know which knobs operate each burner. Make sure you turned on the correct burner.
- To prevent burns, always be sure that the controls for all burners are at the "OFF" position and all grates are cool before attempting to remove them.

SELF-CLEAN OVENS

- **Do Not Clean Door Gasket** – The door gasket is essential for a good seal. Care should be taken not to rub, damage, or move the gasket.
- **Do Not Use Oven Cleaners** – No commercial oven cleaner or oven liner protective coating of any kind should be used in or around any part of the oven.
- **Clean in the self-clean cycle only parts listed in this manual.** Before self-cleaning the oven, remove the broiler pan and any utensils from the oven.
- **Never keep pet birds in the kitchen** – the health of birds is extremely sensitive to the fumes released during an oven self-clean cycle. Fumes may be harmful or fatal to birds. Move birds to well-ventilated room.
- **Important Instruction** – In the event the self-clean mode "F" code goes on, or three long beeps sound, oven is malfunctioning in the self-clean mode. Turn off or disconnect appliance from power supply and have serviced by a qualified technician.

VENTILATING HOODS:

- **Clean Ventilating Hoods Frequently** – Grease should not be allowed to accumulate on hood or filter.
- **When flaming foods under the hood, turn the fan on.**

OVEN

- **Use Care When Opening Door** – Let hot air or steam escape before you remove or replace food in the oven
- **Do Not Heat Unopened Food Containers** – Build-up of pressure may cause container to burst and result in injury.
- **Keep Oven Vent Ducts Unobstructed** – the oven vent is located above the center burner. This area could become hot during oven use. Never block this vent and never place plastic or heat-sensitive items on vent.
- **Placement of Oven Racks** – Always place oven racks in desired location while oven is cool. If rack must be moved while oven is hot, do not let potholder contact hot heating element in oven.
- **Do Not** allow aluminum foil or meat probe to contact heating elements.

DEEP FAT FRYERS:

- Use extreme caution when moving the grease kettle or disposing of hot grease.

GENERAL

MODEL & SERIAL NUMBER LABEL AND TECH SHEET LOCATIONS

The Model/Serial Number label and Tech Sheet locations are shown below.

**Model & Serial
Number Location**

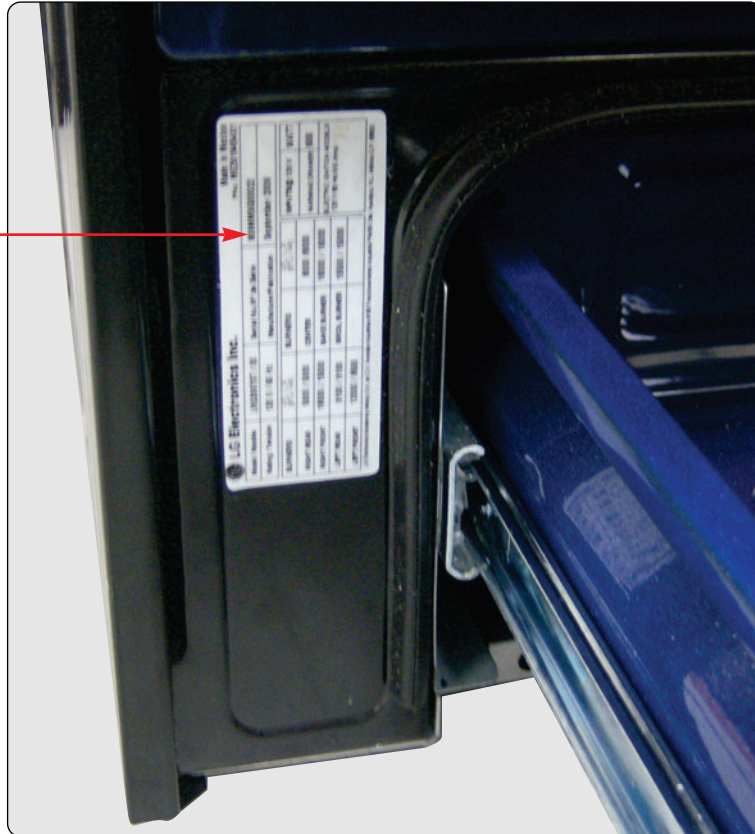

**Tech Sheet Location
(On Low Rear Cover)**

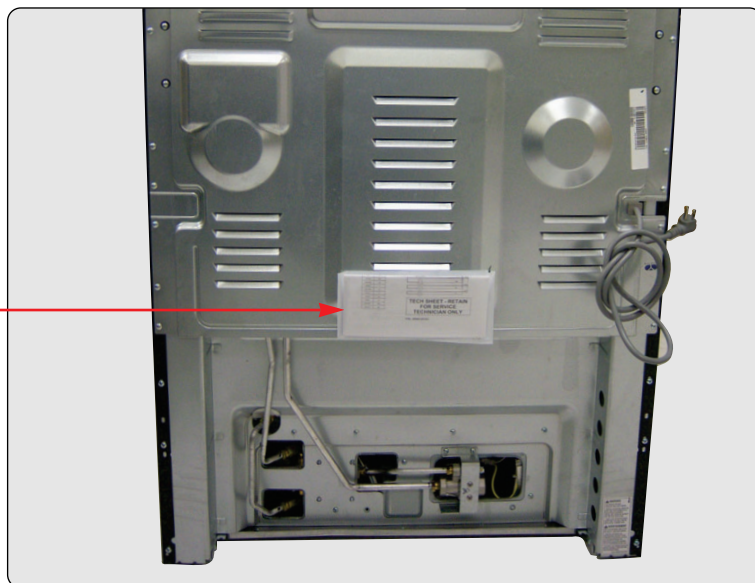

GENERAL

SPECIFICATIONS

Model Number		LRG3093ST	LRG3093SB	LRG3093SW
Category		Non Convection		
Overall	Width	30"		
	Installation type	Freestanding		
	Color availability	STS	Black	White
Control	Oven	Key Pad		
	Cooktop	Knob		
	Display	VFD		
	Electronic clock & timer	Yes		
	Control lock capability	Yes		
	Audible preheat signal	Yes		
	Special function	1. Thermostat Adjustment 2. Preheating Alarm Light On/Off 3. Beeper Volume (High, Low, Off) 4. Temperature unit (°F / °C) 5. Clock (12hr, 24hr)		
Cooktop	Material	Enamel		
	# of element	5	5	5
Input Rate NAT / LP [BTU/hr]	LR	9.1k / 9.1k		
	RR	5k / 5k		
	CR	8k / 8k		
	LF	12k / 9.5k		
	RF	17k / 10k		
Oven	Capacity(cu.fe)	5.4		
	Broil (NAT/ LP)[BTU/hr]	15.5k / 14k		
	Bake (BTU/hr)	18k / 18k		
	Convection system	No		
	# of Racks	2 (standard)		
	Interior oven light	auto / manual		
	Proof	Yes		
	Cook & warm	Yes		
	Favorites	No		
	Door lock out	Yes		
Broiler pan	Yes			
Drawer	Type	Storage		
Dimensions	Oven Interior(W x H x D)	24 1/2 x 18 1/2 x 19 3/8		
	Exterior - Width	30		
	Exterior - Height	36 (cooktop), 47 7/16 (backguard top)		
	Exterior - Depth	26 1/4 (Door), 28 3/4 (with handle)		
	Net weight: lbs (kg)	265 lbs (120kg)		
Power	Rating	120V 4.5A		

USING YOUR RANGE

GENERAL INFORMATION

Rating Label

Model numbers are recorded on the rating label. Rating label is located on the lower front left corner of the oven frame. It can be seen by opening the storage drawer or warming drawer. Before ordering parts, write down the correct model and serial number from rating label. This avoids incorrect shipments and delays. Please refer to parts reference material when ordering replacement parts.

Functional Operation

Bake Mode

Bake burner operates during bake mode. Bake can be used to cook foods which are normally baked. Oven must be preheated.

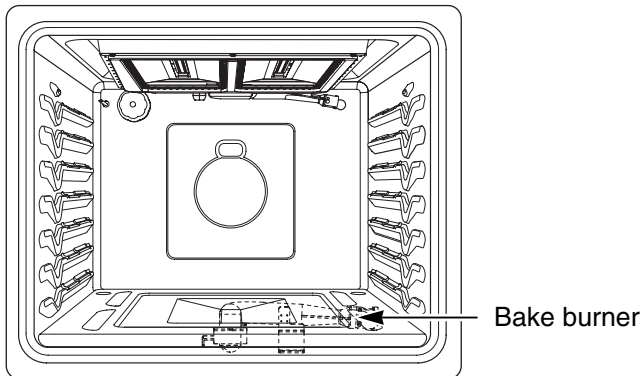

Broil Mode

Broil burner operates during broil mode. Broil can be used to cook foods which are normally broiled. Preheating is not required when using broil. All foods should be turned at least once except fish, which does not need to be turned.

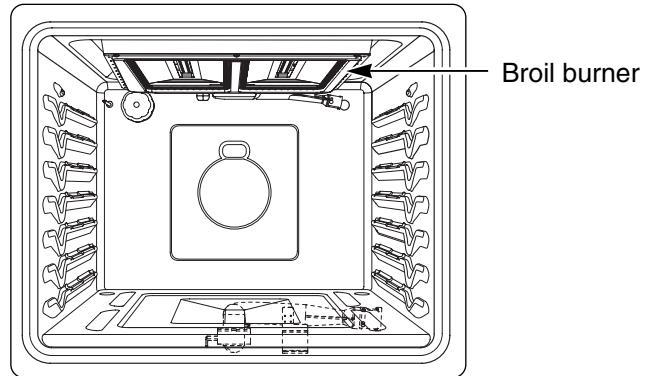

Cooking Guide

Refer to the owners manual for recommendations of times and temperatures. Times, rack position, and temperatures may vary depending on conditions and food type. For best results, always check food at minimum time. When roasting, choose rack position based on size of food item.

USING YOUR RANGE

CONTROL PANEL FEATURES

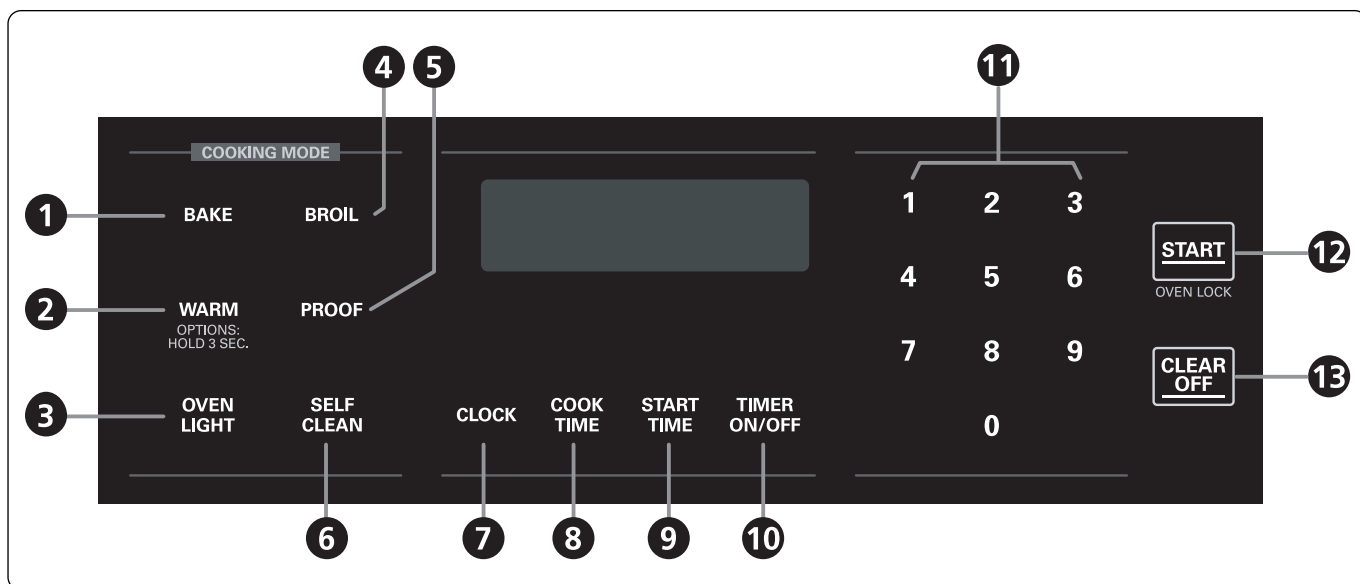

- 1. BAKE PAD** – Press the pad to enter the normal bake function.
- 2. WARM PAD / OPTIONS**
 - Press this pad to hold food warm in the oven.
 - Press and hold the pad for 3 seconds to change the special settings.

NOTE: Special settings can only be used if no other function (Bake, Broil, Timer Ect.) of the control panel is in use.
- 3. OVEN LIGHT PAD** – Press the pad to turn the oven light on or off.
- 4. BROIL PAD** – Press the pad to select broil function.
- 5. PROOF PAD** – Press the pad to proof bread.
- 6. SELF CLEAN PAD** – Press the pad to select self-cleaning function.
- 7. CLOCK PAD** – Press the pad to set the time of day.
- 8. COOK TIME PAD** – Press this pad and then press the number pads to set the amount of time you want your food to cook. The oven will shut off when the cooking time has run out.
- 9. START TIME PAD** – Press this pad and then press the number pad to set delayed start time. The oven will start at a time you set.
- 10. TIMER ON/OFF PAD** – Press the pad to set or cancel the timer function.
- 11. NUMBER PADS** – Use to set any function requiring numbers such as clock, timer or temperature.
- 12. START PAD / OVEN LOCK**
 - Press the pad to start all oven features.
 - Press and hold the pad for 3 seconds to activate/deactivate the Oven Lockout function.
- 13. CLEAR OFF PAD** – Press this pad to cancel ALL oven operations except the clock, timer and warming drawer settings.

USING YOUR RANGE

1. TO TURN ON THE SURFACE BURNER

1. Be sure all the surface burners are placed in their respective positions.
2. Push the control knob in and turn it to the "LITE" positions.
3. You can hear a little CLICKING noise - the sound of the electric spark igniting the burners.
4. To control the flame size, turn the knob. If the knob stays at "LITE", it will continue to click.

NOTE:

- When turning a burner to LITE, all the burners spark. Do not attempt to disassemble or clean around any burner while another burner is on. An electric shock may result, which could cause you to knock over hot cookware.
- The medium (left rear) and the large (left front) burners are the primary burners for most cooking. These general-purpose burners can be turned down from "HI" to "LO" suit a wide range of cooking needs.
- The extra large burner (right front) is the maximum output burner. Like the other four burners, it can be turned down from "HI" to "LO" for a wide range of cooking applications.
- This burner is also designed to quickly bring large amounts of liquid to a boil. It has a special "Ultra Heat" setting designed to be used with cookware 10 inches or larger in diameter.
- The oval burner (center) is for large pots/pans or for use with the griddle.
- The extra large burner (dual) can be also turned down to "LO" for a low simmer setting almost like the small burner.

2. SETTING THE CLOCK

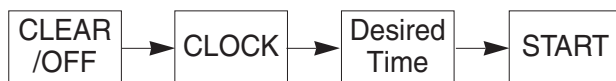

3. START, CLEAR/OFF

1. Touch **START** pad to start oven.
2. Touch **CLEAR/OFF** pad to cancel a program during cooking or Erase during programming.

4. TO TURN ON/OFF THE OVEN LIGHT

The oven light automatically turns ON when the door is opened. The oven light may also be manually turned ON or OFF by press the **OVEN LIGHT** pad

NOTE: The oven light cannot be turned on if self-clean feature is active.

5. TIMER ON/OFF

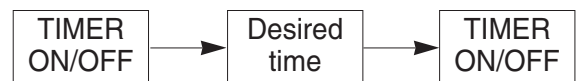

To cancel timer at any time, touch **TIMER ON/OFF** pad.

NOTE:

1. If you press **TIMER ON/OFF** pad once, this allows you to select "seconds"
(for example: if you press "5" and "6", it means 56 seconds)
2. If you press **TIMER ON/OFF** pad twice, this allows you to select "minutes"
(for example: if you press "5" and "6", it means 56 minutes)

6. WARM(OPTIONS: HOLD 3 SEC) PAD : (6 types of category).

1) OVEN TEMPERATURE ADJUSTMENT

The oven temperature can be adjusted from -35°F (-19°C) to 35°F (19°C).

NOTE: The oven temperature adjustments made with this feature will just change Bake, temperature.

To increase the oven temperature:

1. Press and hold the pad for 3 seconds.
2. Press **the desired temperature**
3. Press **START** pad.

To decrease the oven temperature:

1. Press and hold the pad for 3 seconds.
2. Press **the desired temperature**
3. Press the **WARM** pad once
4. Press **START** pad

USING YOUR RANGE

2) PREHEATING ALARM LIGHT ON/OFF

1. Press and hold the pad for 3 seconds. Then press the WARM pad once.
2. Press "1" pad to switch between **ON** and **OFF**
3. Press **START** pad

3) BEEPER VOLUME

1. Press and hold the pad for 3 seconds. Then press the WARM pad twice.
2. Press "1" pad to switch beeper volume (Hi, Lo and Off)
3. Press **START** pad

4) TEMPERATURE UNIT (°F or °C)

1. Press and hold the pad for 3 seconds. Then press the WARM pad 5 times.
2. Press "1" pad to switch between the °F and °C.
3. Press **START** pad

7. BAKE, TIMED BAKE, DELAYED TIMED BAKE

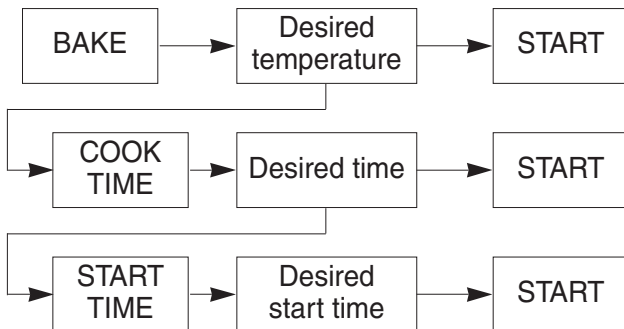

8. BROIL

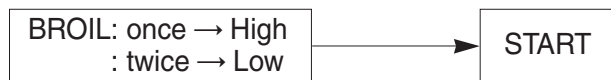

9. WARM



10. TIMED COOK WITH WARM

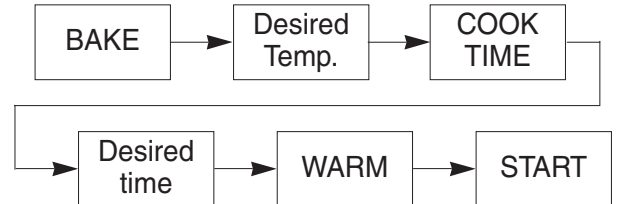

11. OVEN LOCKOUT

Press and hold the **CLOCK** pad for 3 seconds (to activate or reactivate LOCKOUT)

12. CHANGING HOUR MODE ON CLOCK (12HR, 24HR)

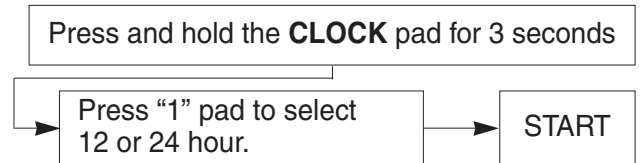

13. PROOF



14. SELF-CLEAN

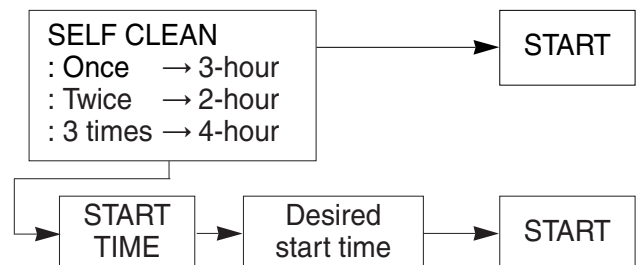

COMPONENT ACCESS

This section instructs you on how to service each component inside the range. The components and their locations are shown below.

COMPONENT LOCATIONS

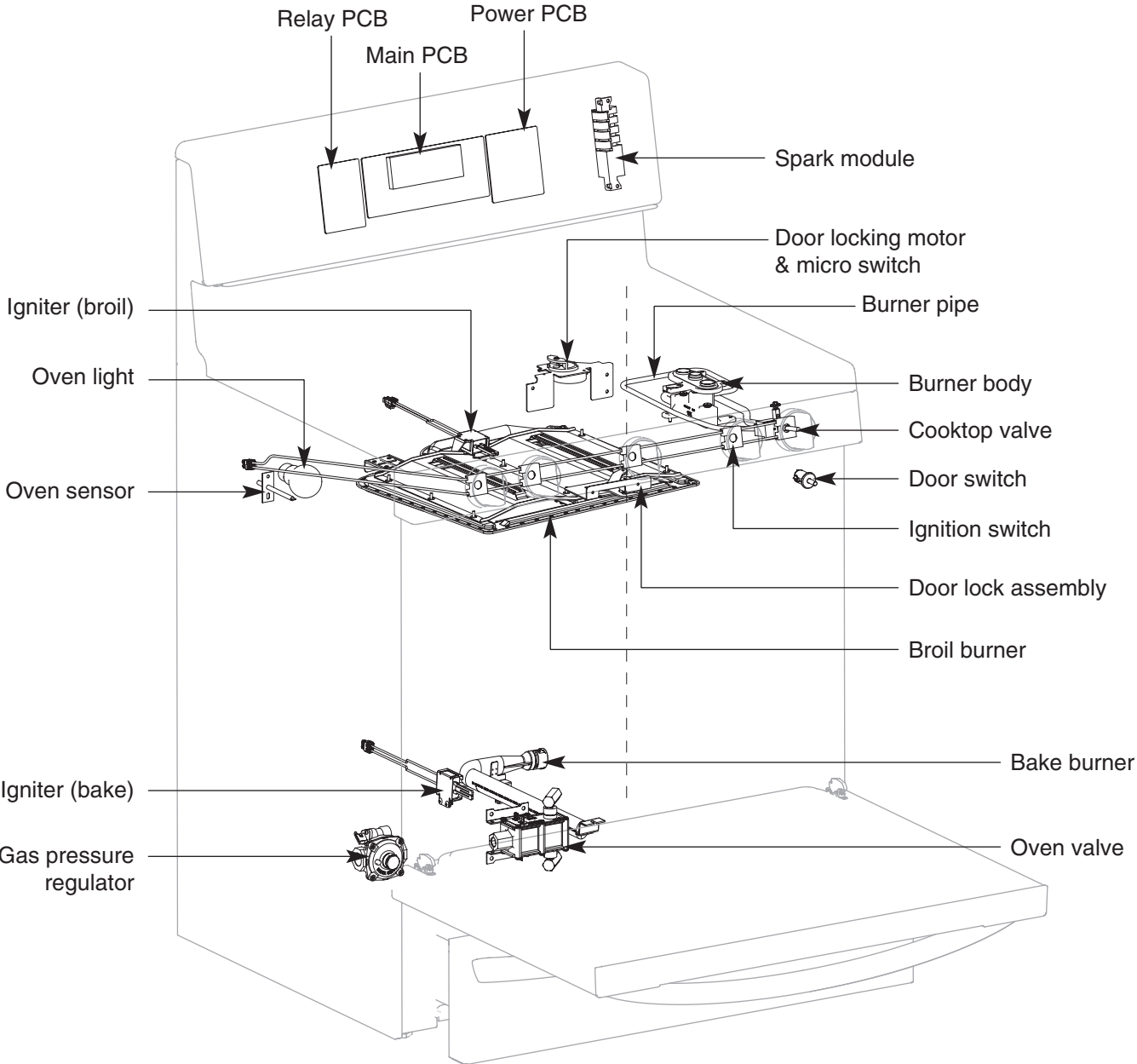

COMPONENT ACCESS

REMOVING THE BACK, CONTROL COVER AND KEY PAD ASSEMBLY

WARNING

- **DISCONNECT** power supply cord from the outlet before servicing.
- **Replace** all panels and parts before operating.
- **RECONNECT** all grounding devices.
 - Failure to do so can result in severe personal injury, death or electrical shock.

CAUTION

- **Be careful when you work on the gas range handling the sheet metal part.**
 - Sharp edge may be present and you can cut yourself.

1. Turn off the electrical supply and gas supply going to the range.
2. Pull the range away from the wall so that you can access the rear panel.
3. Remove two wire covers by removing the screw.
4. Remove the 3 screws from the rear control cover and remove the cover.
5. Remove the 16 screws from the rear back cover and remove the cover.

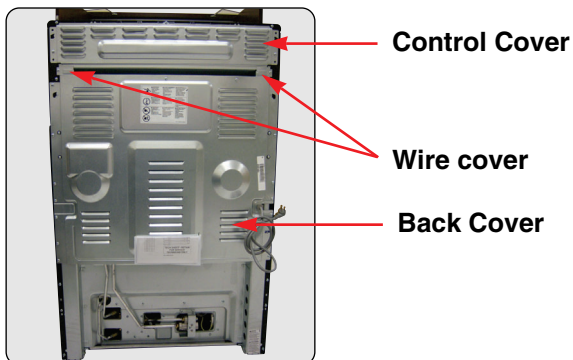

6. Remove the 5 screws of PCB assembly and separate PCB assembly after unplugging the connectors.

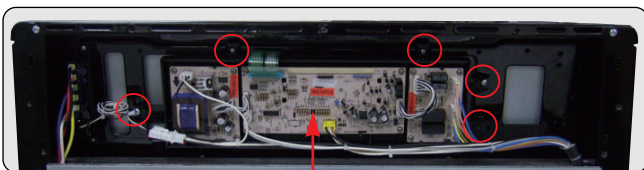

PCB Assembly

7. Remove the 2 screws of the eyebrow from the controller sub assembly and remove the eyebrow.

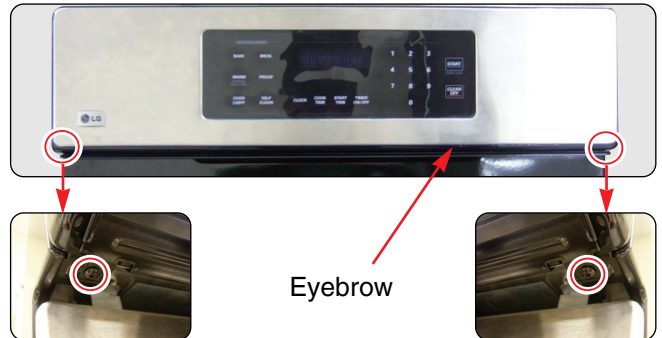

8. Remove the 2 screws of the controller sub assembly.



9. Pull the controller sub assembly and lift it up from the supporters.

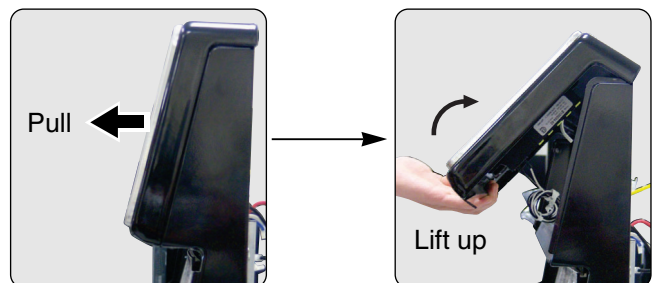

10. For servicing the key pad PCB, the controller sub assembly should be separated in whole except the spark module (IG trans).

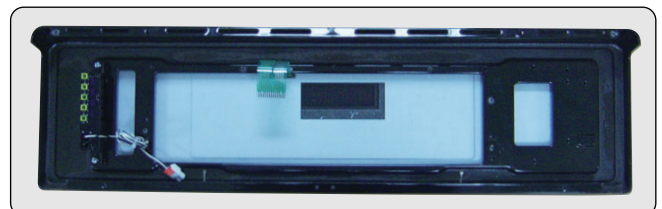

COMPONENT ACCESS

REMOVING THE SPARK MODULE (IG TRANS) AND POWER CONTROL BOARD (PCB)

WARNING

- **DISCONNECT** power supply cord from the outlet before servicing.
- **Replace** all panels and parts before operating.
- **RECONNECT** all grounding devices.
 - Failure to do so can result in severe personal injury, death or electrical shock.

CAUTION

- **Be careful** when you work on the gas range handling the sheet metal part.
 - Sharp edge may be present and you can cut yourself.

1. Turn off the electrical supply and gas supply going to the range.
2. Pull the range away from the wall so that you can access the rear panel.
3. Remove wire cover & control cover (See step 3~4 on page 3-2)

4. There are 3 PCB's (power control board). When you check PCB, check the proper pcb in default mode and check main pcb.

NOTE: Refer to the page 6-1~6-2 for composition of control board

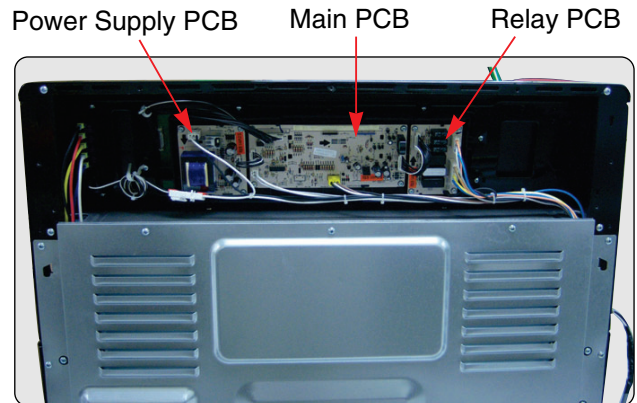

5. **5 connectors of the electrode and a connector of the harness.**

- a) Disconnect 6 connectors.
- b) Remove the 2 screws.
- c) Remove the 2 tabs by using long nose pliers.

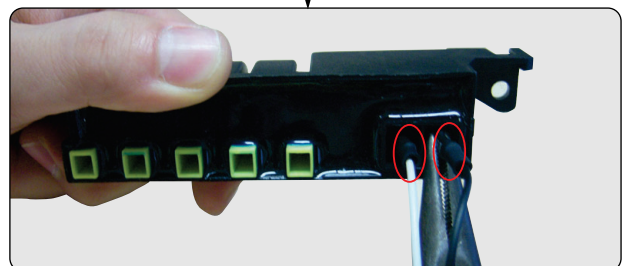
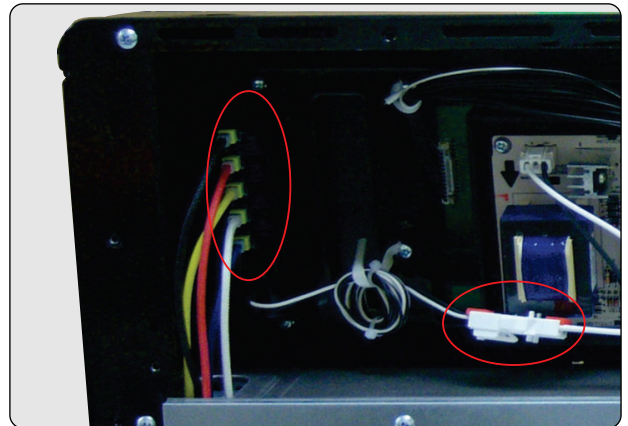

COMPONENT ACCESS

REMOVING THE COOKTOP PLATE

WARNING

- **DISCONNECT** power supply cord from the outlet before servicing.
- **Replace** all panels and parts before operating.
- **RECONNECT** all grounding devices.
 - Failure to do so can result in severe personal injury, death or electrical shock.

1. Turn off the electrical supply and gas supply going to the range.
2. Remove the griddle, grates, burner caps and burner heads.
3. Remove all 15 screws from cooktop burner housings.
4. Disengage 2 front clips using a flat blade screwdriver.



5. Lift top up at front.

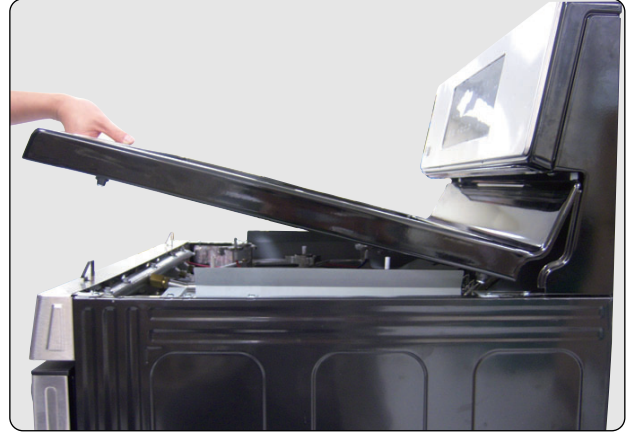

NOTE : Before lowering the top onto the front clips, line up the burner body and with the cooktop to replace screws.

COMPONENT ACCESS

REMOVING THE CASE ASSEMBLY (COOKTOP BURNER ASSEMBLY)

WARNING

- **DISCONNECT** power supply cord from the outlet before servicing.
- **Replace** all panels and parts before operating.
- **RECONNECT** all grounding devices.
 - Failure to do so can result in severe personal injury, death or electrical shock.

1. Turn off the electrical supply and gas supply going to the range.
2. Remove the cooktop plate (See “REMOVING THE COOKTOP PLATE” on page 3-4).
3. Remove the manifold panel by unfastening the 9 phillips head screws.

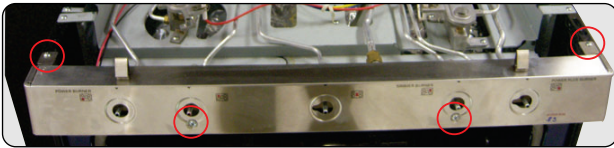

4. Remove the tubing fitting (5/8-inch).
5. Remove 5 phillips head screws.

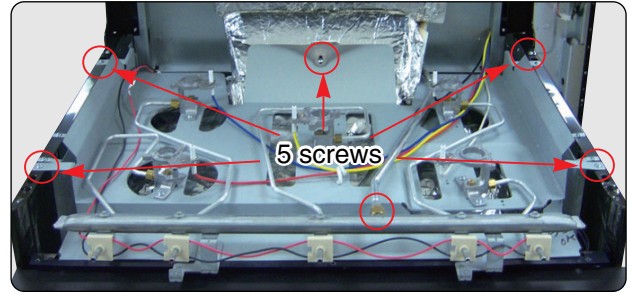

COMPONENT ACCESS

REMOVING THE COOKTOP PARTS

WARNING

- **DISCONNECT** power supply cord from the outlet before servicing.
- **Replace all panels and parts before operating.**
- **RECONNECT** all grounding devices.
 - Failure to do so can result in severe personal injury, death or electrical shock.

CAUTION

- The 2 lock tabs on each igniter switch are fragile. Tab breakage can occur if excessive release pressure is applied.
- Check that the gas seal gasket on the screw and the gas valve remain in place before installing the new gas valve.

NOTE: When servicing the burner housing or the valve, it is necessary to service also the pipe which is designated.

1. Turn off the electrical supply and gas supply going to the range.
2. Remove the cooktop plate (See "REMOVING THE COOKTOP PLATE" on page 3-4).

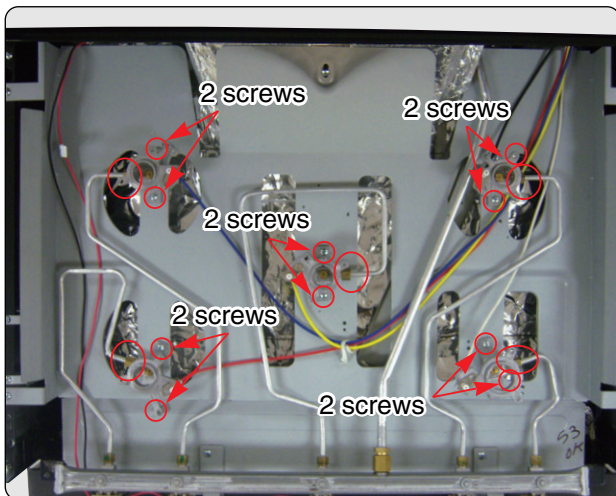

4. To remove the valve:
 - a) Remove the manifold panel (See the step 3 on page 3-5).
 - b) Remove the fitting that you need to remove.
 - c) Remove the ignition switch by prying on the 2 release tabs and slide the switch off the valve stem.
 - d) Remove the valve screw and remove the valve.

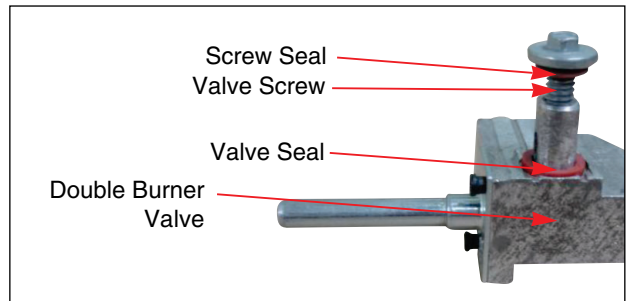
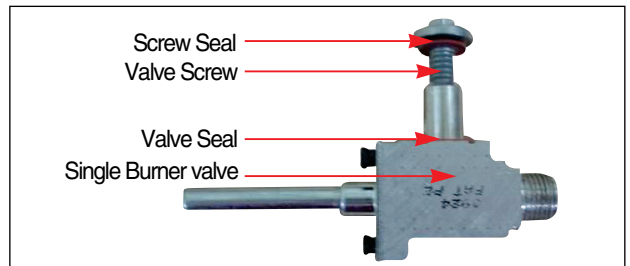
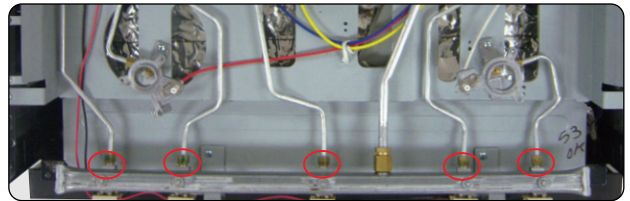

COMPONENT ACCESS

5. To remove the ignition switch:
 - a) Remove the manifold panel (See the step 3 on page 3-5).
 - b) Pry on the 2 release tabs and slide the switch off the valve stem.
 - c) Remove the connector and remove the ignition switch.

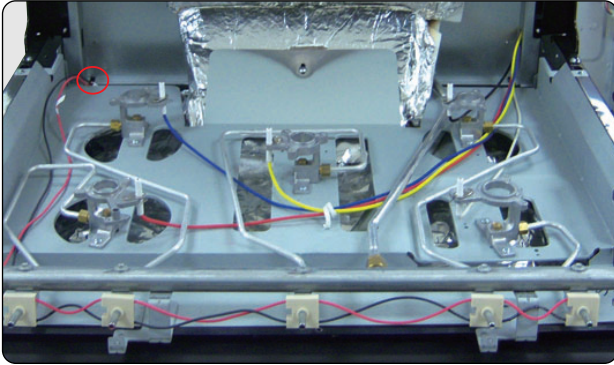

6. To remove the electrode (spark plug):
 - a) Remove the rear control panel (See the step 2-3 on page 3-2).
 - b) Remove the connector from the spark module.
 - c) Remove the wire ring
 - d) Remove the electrode from the burner housing.

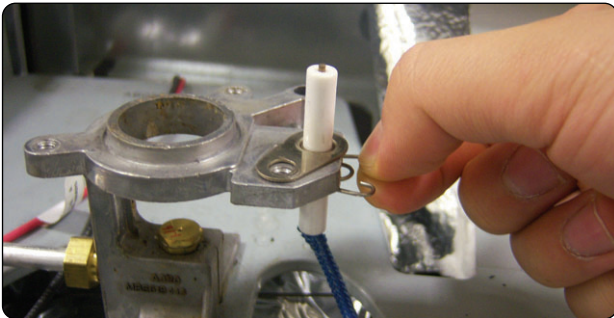

COMPONENT ACCESS

REMOVING THE DOOR LATCH & DOOR SWITCH

⚠ WARNING

- **DISCONNECT** power supply cord from the outlet before servicing.
- **Replace** all panels and parts before operating.
- **RECONNECT** all grounding devices.
 - Failure to do so can result in severe personal injury, death or electrical shock.

⚠ CAUTION

- **Be careful** when you work on the gas range handling the sheet metal part.
 - Sharp edge may be present and you can cut yourself.

1. Turn off the electrical supply and gas supply going to the range.
2. Open the oven door.
3. Remove the cooktop plate, manifold and the case assembly (see page 3-5 for the procedure).
4. To remove the door latch:
 - a) Remove the two screws from the door latch and remove the latch.



2 Screws

- b) Remove the 2 screws and then remove the bar from the door latch.

- c) Remove the door latch.

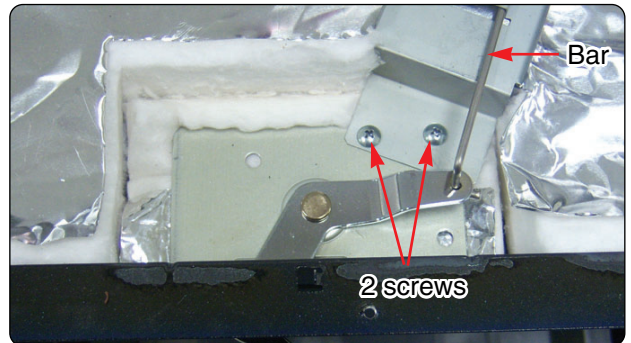

5. To remove the door switch:

- a) Remove the door switch from the range. To do this, squeeze tabs and use a ratchet extension or a small socket, and tap it out of the hole with a hammer.

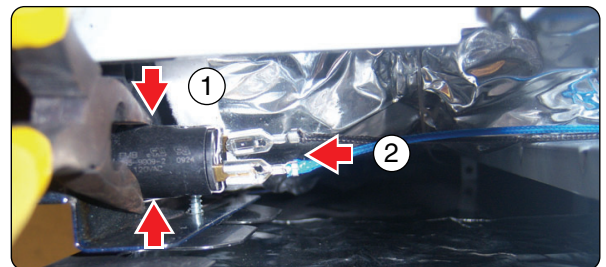

- b) Disconnect the wires from the terminals.

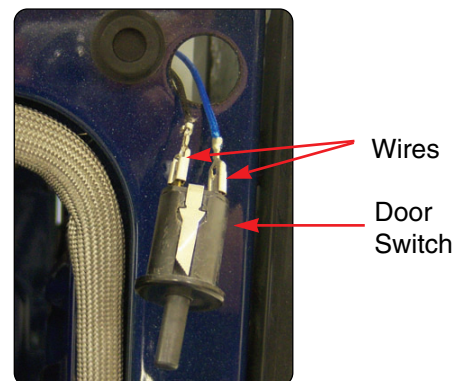

COMPONENT ACCESS

REMOVING THE BROIL BURNER ASSEMBLY

WARNING

- **DISCONNECT** power supply cord from the outlet before servicing.
- **Replace all panels and parts before operating.**
- **RECONNECT** all grounding devices.
 - Failure to do so can result in severe personal injury, death or electrical shock.
- **Make sure the igniter connector is completely outside when reinstalling the broil burner assembly.**

CAUTION

- **Be careful when you work on the gas range handling the sheet metal part.**
 - Sharp edge may be present and you can cut yourself.

1. Turn off the electrical supply and gas supply going to the range.
2. Remove the oven door and remove the racks from inside the oven.
3. **To remove the broil Burner assembly:**
 - a) Remove the wire cover by removing the screw.
 - b) Remove the 4 screws in the order for easily removing.
 - c) Remove the broil burner assembly.

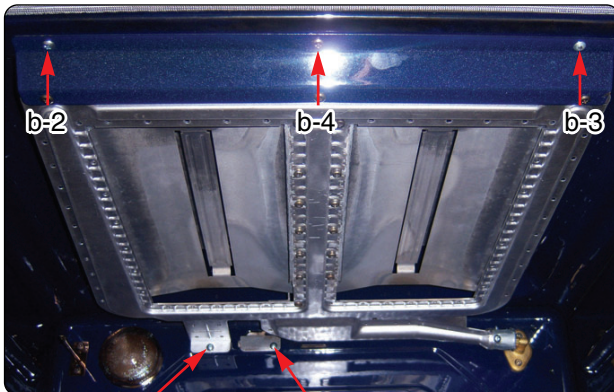

b-1 a) Wire cover screw

- d) Remove the igniter connector in the cavity (To get the connector, pull the wire toward the cavity).
- e) Remove the broil burner assembly.

NOTE : When removing the screws, make sure holding the Broil burner assembly.

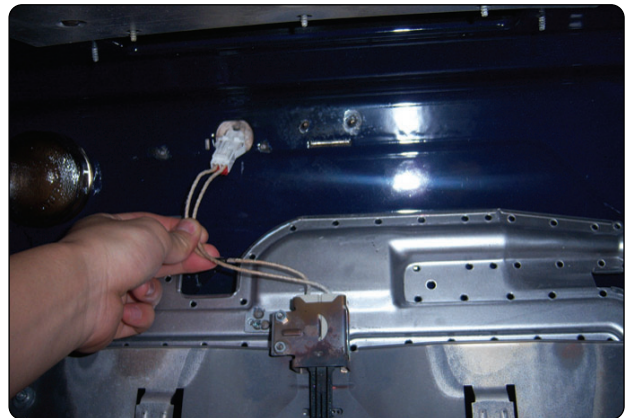

4. To remove the igniter:
 - a) Perform step 1-3 on this page.
 - b) Remove the 2 screws and then remove the igniter.

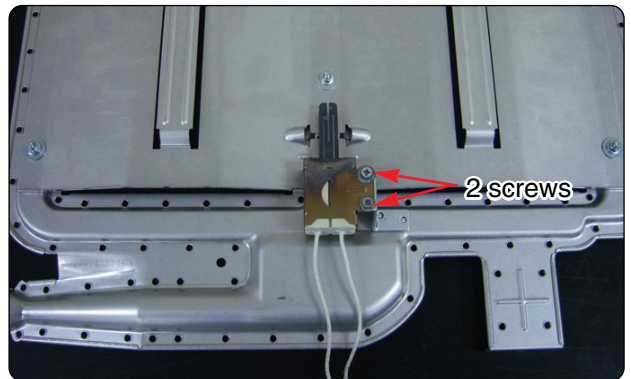

COMPONENT ACCESS

OVEN BOTTOM, THE FRAME GUIDE AND THE BURNER ASSEMBLY

1. Turn off the electrical supply and gas supply going to the range.
2. Remove the drawer and then disconnect the igniter plug.

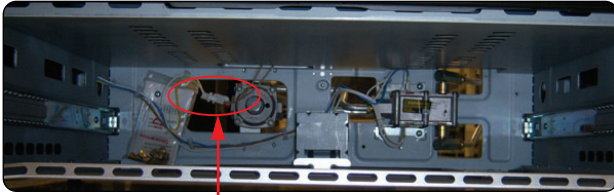

Igniter plug

3. Remove the oven door and racks from inside of the oven.
4. To remove the oven bottom:
 - Remove the 2 screws and then remove oven bottom.

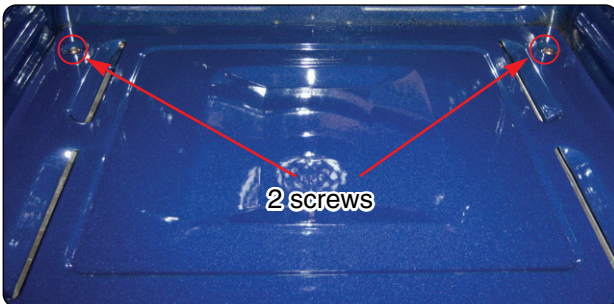

2 screws

5. To remove the flame guide:
 - Remove the 4 screws and then remove flame guide.

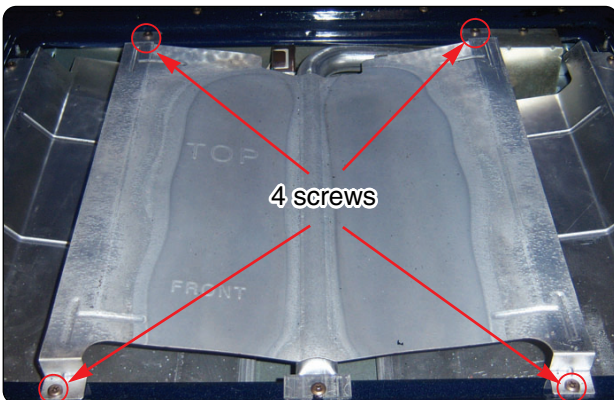

4 screws

6. To remove the nozzle case:
 - Remove the screw and then remove nozzle case.

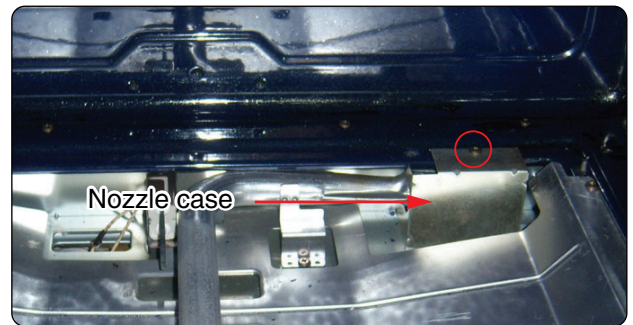

Nozzle case

7. To remove the bake burner assembly:
 - Remove the 2 screws and then remove the burner assembly.

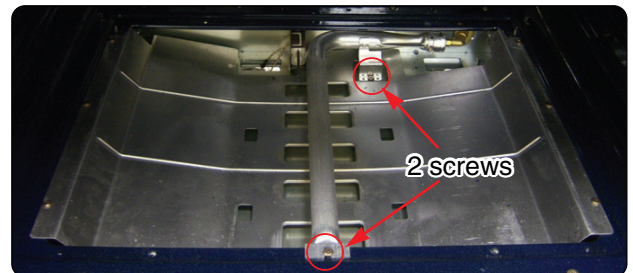

2 screws

8. To remove the igniter:
 - Remove the 2 screws and then remove the igniter.

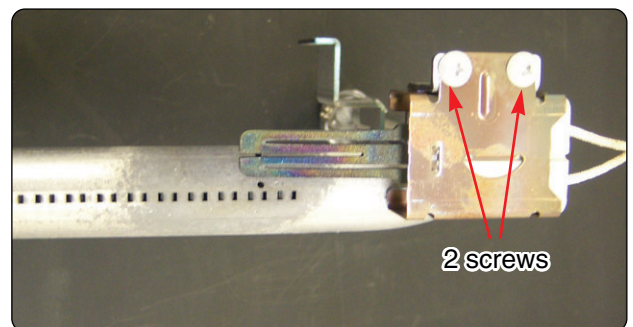

2 screws

COMPONENT ACCESS

REMOVING THE OVEN LIGHT & SOCKET ASSEMBLY

⚠ WARNING

- **DISCONNECT** power supply cord from the outlet before servicing.
- Replace all panels and parts before operating.
- **RECONNECT** all grounding devices.
 - Failure to do so can result in severe personal injury, death or electrical shock.

⚠ CAUTION

- Be careful when you work on the gas range handling the sheet metal part.
 - Sharp edge may be present and you can cut yourself.

To replace:

1. Turn off the electrical supply and gas supply going to the range.
2. Turn the glass bulb cover in the back of the oven counterclockwise to remove.
3. Turn bulb counterclockwise to remove from socket.
4. Replace bulb and bulb cover by turning clockwise.

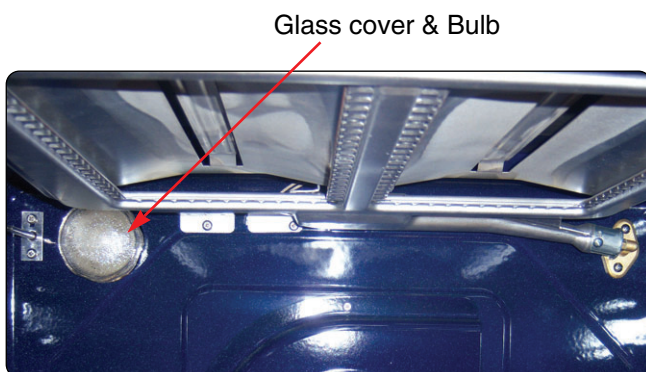

⚠ CAUTION

- Be careful not to scratch or chip the oven liner paint when you remove the oven light socket in the next step.

5. Use a screwdriver and bend the clips on the oven light socket away from the edges of the liner hole, and pull the socket out of the liner.

NOTE: If it is too difficult to remove the socket from the front of the oven, you will have to push the socket out from the back of the unit.

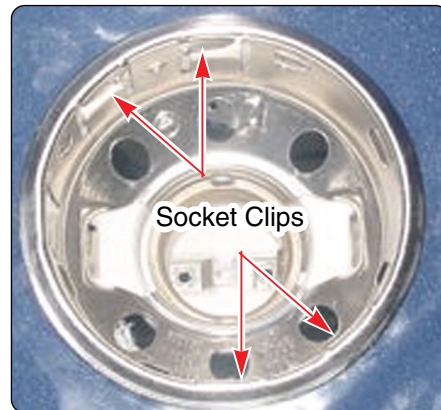

6. Disconnect the wires from the socket terminals.

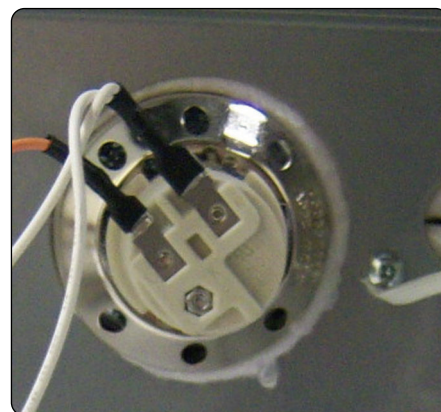

<Viewed From Rear Panel>

COMPONENT ACCESS

REMOVING THE LATCH DRIVE ASSEMBLY

⚠ WARNING

- **DISCONNECT** power supply cord from the outlet before servicing.
- **Replace** all panels and parts before operating.
- **RECONNECT** all grounding devices.
 - Failure to do so can result in severe personal injury, death or electrical shock.

⚠ CAUTION

- **Be careful** when you work on the gas range handling the sheet metal part.
 - Sharp edge may be present and you can cut yourself.

1. Turn off the electrical supply and gas supply going to the range.
2. Pull the range away from the wall so that you can access the rear panel.
3. Remove the back cover (see step 5 on page 3-2).
4. Disconnect the wires from the latch drive motor and switch.
5. Remove the 3 mounting screws from the latch drive.

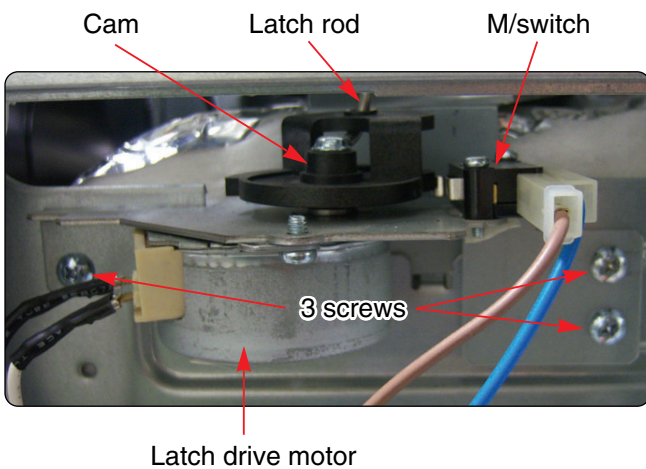

6. Unhook the Latch rod from the cam.

DOOR LOCKING MECHANISM

The door lock assembly is located at the back side of range.

The structural elements are as below.

1. When the oven control is programmed and started for the Self clean and Lock out mode, PCB (Power control board) chip operates the motor.

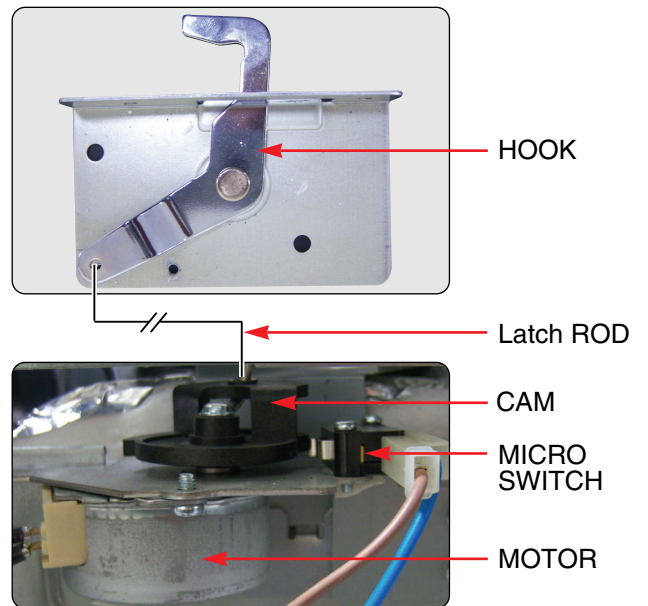

2. The cam moves the door hook connected to latch rod from unlocked position to locked position (from locked Position to unlocked position)
3. The cam activates the micro switch that causes the motor to stop.
4. The locked status remains until the range temperature drops to approximately 500F after end of the self clean or lock out feature is reactivated. The motor operates to unlock door at that time.

COMPONENT ACCESS

REMOVING THE OVEN TEMPERATURE SENSORS

WARNING

- **DISCONNECT** power supply cord from the outlet before servicing.
- **Replace** all panels and parts before operating.
- **RECONNECT** all grounding devices.
 - Failure to do so can result in severe personal injury, death or electrical shock.

CAUTION

- **Be careful** when you work on the gas range handling the sheet metal part.
 - Sharp edge may be present and you can cut yourself.

1. Turn off the electrical supply and gas supply going to the range.
2. Open the oven door and remove the racks from the oven.
3. To remove an oven temperature sensor :
 - a) Remove the 2 screws.
 - b) Remove the connector in the cavity (To get the connector, pull the wire toward the cavity).
 - c) Remove the oven sensor.



Oven temperature sensor

COMPONENT ACCESS

REMOVING & REPLACING THE WARMING DRAWER

WARNING

- **DISCONNECT** power supply cord from the outlet before servicing.
- **Replace all panels and parts before operating.**
- **RECONNECT** all grounding devices.
 - Failure to do so can result in severe personal injury, death or electrical shock.

CAUTION

- **Be careful when you work on the gas range handling the sheet metal part.**
 - Sharp edge may be present and you can cut yourself.

To Remove Storage Drawer:

CAUTION

- **Turn power OFF** before removing the storage drawer.

1. Pull the drawer out until it stops.
2. Lift the front of the drawer until the stops clear the guides.
3. Remove the drawer.

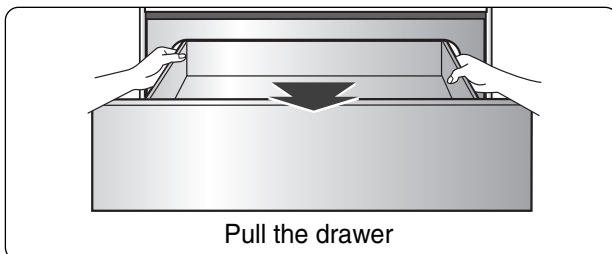

To Replace the Storage Drawer:

1. Place the drawer rails on the guides.
2. Push the drawer back until it stops.
3. Lift the front of the drawer and push back until the stops clear the guides.
4. Lower the front of the drawer and push back until it closes.

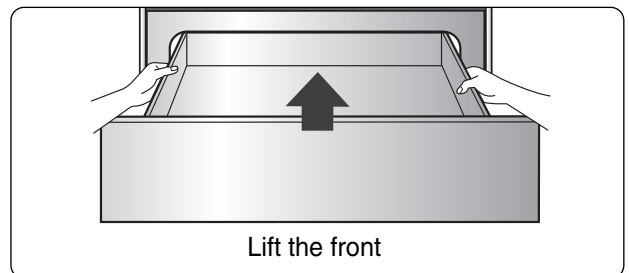

COMPONENT ACCESS

REMOVING & REPLACING THE LIFT-OFF OVEN DOOR

CAUTION

- Be careful when removing and lifting the door.
- DO NOT lift the door by the handle.
 - Failure to do so can result in personal injury as the door is very heavy.

To remove the door:

1. Fully open the door.

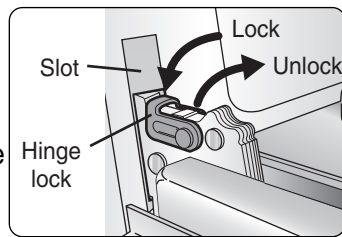

<Fig.1>

2. Pull the hinge locks down toward (Fig.1) the door frame, to the unlocked position.

3. Firmly grasp both sides of the door at the top.

4. Close door to the door removal position, which is approximately 5 degrees. (refer to the Fig.2)

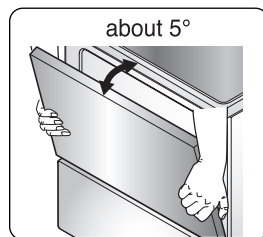

<Fig.2>

5. Lift door up and out until the hinge arm is clear of the slot.

To replace the door:

1. Firmly grasp both sides of the door at the top.

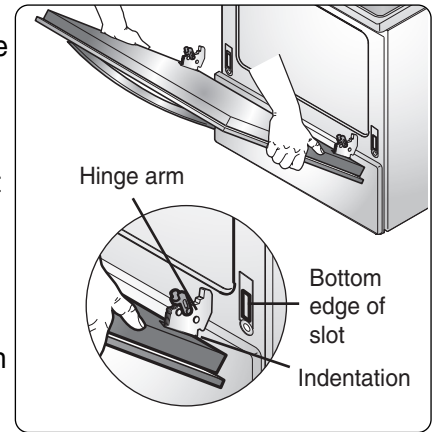

2. With the door at the same angle as the removal position, seat the indentation of the hinge arm into the bottom edge of the hinge slot. The notch in the hinge arm must be fully seated into the bottom of the slot.

3. Fully open the door. If the door will not fully open, the indentation is not seated correctly in the bottom edge of the slot.

4. Push the hinge locks up against the front frame of the oven cavity to the locked position.

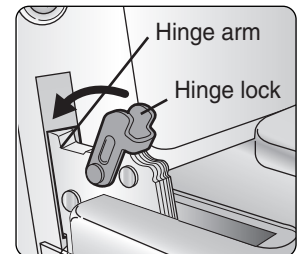

5. Close the oven door.

COMPONENT ACCESS

REMOVING THE OVEN DOOR HANDLE & GLASS

WARNING

- **DISCONNECT** power supply cord from the outlet before servicing.
- **Replace** all panels and parts before operating.
- **RECONNECT** all grounding devices.
 - Failure to do so can result in severe personal injury, death or electrical shock.

CAUTION

- **Be careful** when you work on the gas range handling the sheet metal part.
 - Sharp edge may be present and you can cut yourself.

1. Remove the oven door from the range (see page 3-15 for the procedure).
2. Place the oven door on a padded work surface with the front glass facing down.
3. Remove the 4 top door screws.

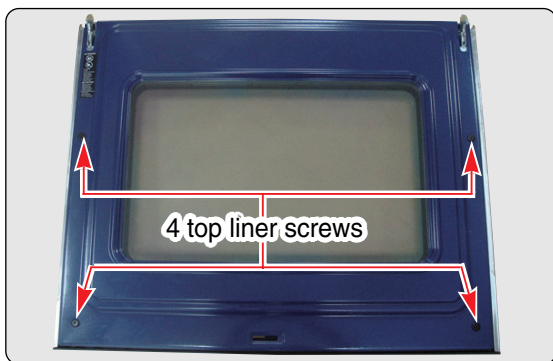

4. Remove the three bottom screws from the door liner.

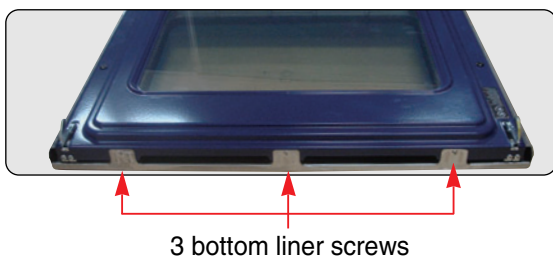

5. Lift the liner assembly off the front glass and set it aside.

LGE Internal Use Only

6. To remove the door handle & trim

- a) Remove the 4 door handle screws and lift the door handle off door trim and slide up the door trim.

2 door handle screws

2 door handle screws

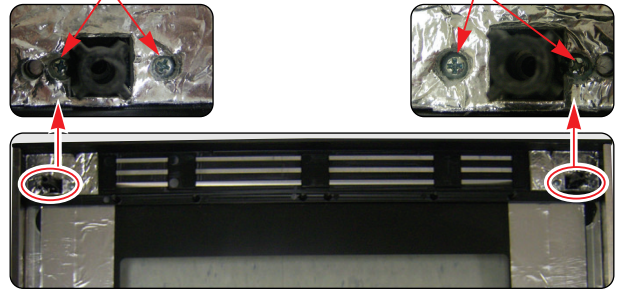

7. To remove the door handle trim & glass

(for white / Black model)

- a) **Remove the handle and glass trim screws**

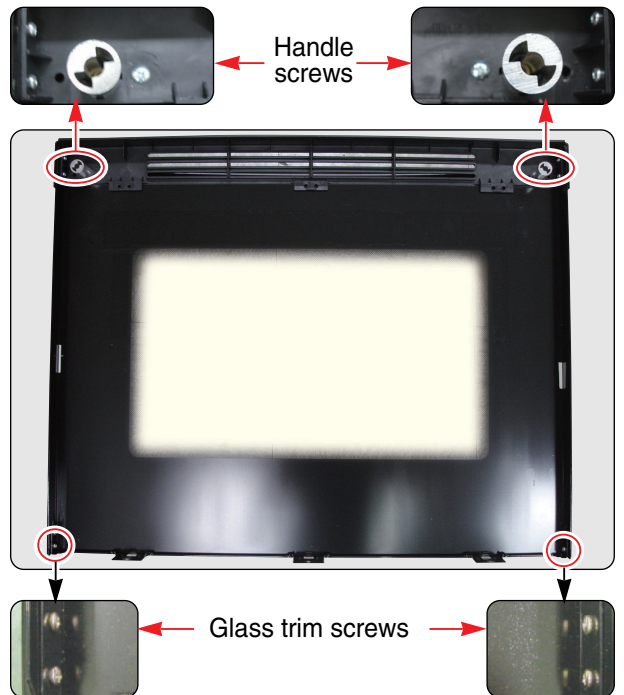

- b) **Lift the door handle off door trim**

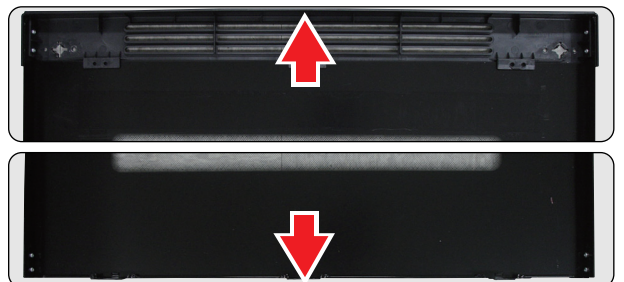

- c) **Slide up the door trim and pull the glass trim forward**

COMPONENT ACCESS

8. To remove a hinge hanger assembly:

- Remove the 2 top liner screws
(See step 3 on page 3-14)
- Place the door liner assembly on a padded work surface with the hinge hangers over the edge.
- Remove the two bottom screws.
- Lift the hinge hanger out of the door liner slot.



- Lift the inner oven door glass and bracket assembly out of the door liner.



REASSEMBLY NOTE: When you reinstall the insulation around the oven door glass, make sure that the insulation is not visible in the glass after the door is reassembled.

9. To remove the oven door glass assembly:

- Remove the 8 screws.
- Lift the insulation cover off the door liner.



COMPONENT ACCESS

REMOVING THE OVEN DOOR GASKET

WARNING

- **DISCONNECT** power supply cord from the outlet before servicing.
- **Replace** all panels and parts before operating.
- **RECONNECT** all grounding devices.
 - Failure to do so can result in severe personal injury, death or electrical shock.

CAUTION

- **Be careful** when you work on the gas range handling the sheet metal part.
 - Sharp edge may be present and you can cut yourself.

1. Open the oven door to its fully down position.
2. Pull the oven door gasket clips out of the liner holes until all of the clips are removed.

3. Pull the ends of the gasket out of the liner holes.

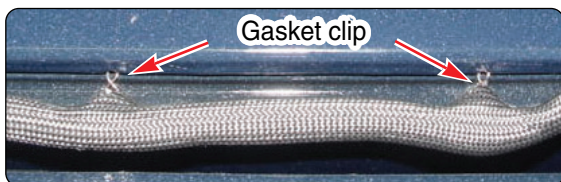
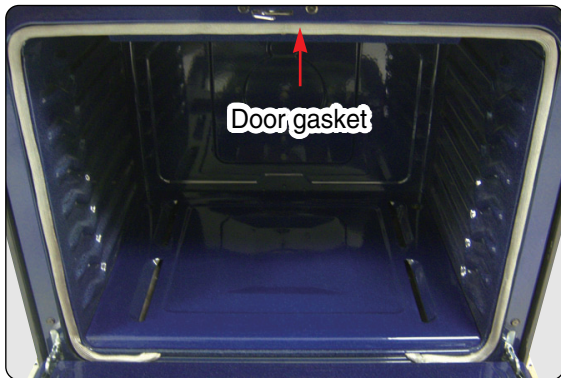
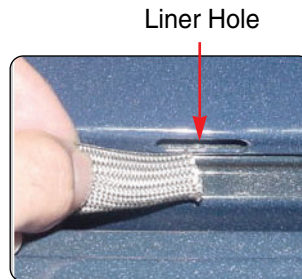

COMPONENT ACCESS

REMOVING A SIDE PANEL

WARNING

- **DISCONNECT** power supply cord from the outlet before servicing.
- **Replace all panels and parts before operating.**
- **RECONNECT** all grounding devices.
 - Failure to do so can result in severe personal injury, death or electrical shock.

CAUTION

- **Be careful when you work on the gas range handling the sheet metal part.**
 - Sharp edge may be present and you can cut yourself.

1. Turn off the electrical supply and gas supply going to the range.
2. Remove the oven door from the range (see page 3-12 for the procedure).
3. Pull the range away from the wall so you can access the back of the unit.
4. Remove the 15 screws from the rear panel and remove the panel (see step 4 on page 3-2).
5. Raise the cooktop plate (see the page 3-4 for the procedure).
6. Remove the two screws from the top rear of the side panel.



7. Remove the 6 screws from the left or right side panel.

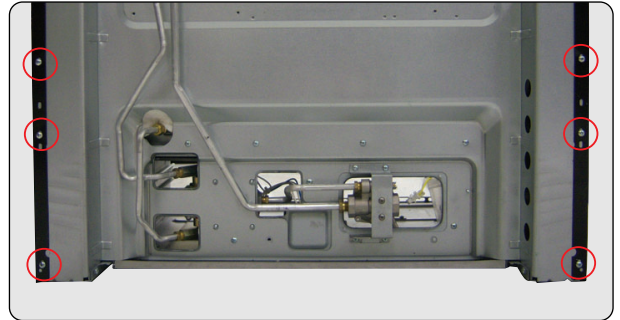

8. Pull the back of the side panel out from the range approximately 10°.

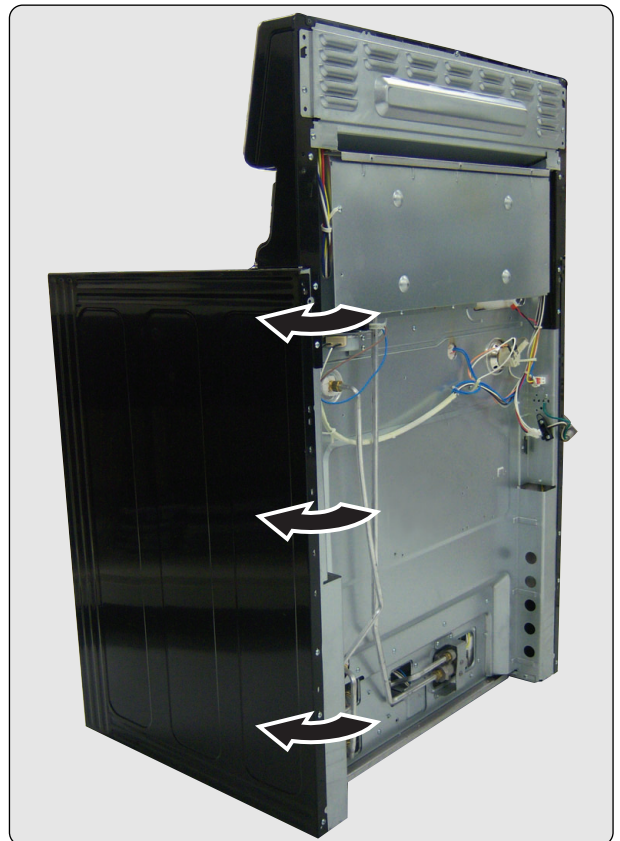

9. Push forward and remove the side panel.

COMPONENT ACCESS

REMOVE THE OVEN VALVE (SAFETY VALVE) & GAS REGULATOR

⚠ WARNING

- **DISCONNECT** power supply cord from the outlet before servicing.
- **Replace** all panels and parts before operating.
- **RECONNECT** all grounding devices.
 - Failure to do so can result in severe personal injury, death or electrical shock.

⚠ CAUTION

- **Be careful** when you work on the gas range handling the sheet metal part.
 - Sharp edge may be present and you can cut yourself.

1. Turn off the electrical supply and gas supply going to the range.
2. Pull the range away from the wall so you can access the pipe of the unit.
3. To remove the oven valve:
 - a) Remove the drawer (see page 3-13 for the procedure).
 - b) Remove the 3 fittings.

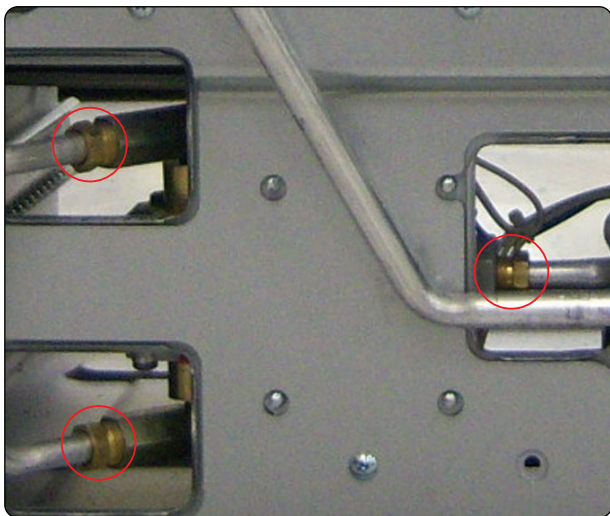

- c) Remove the 4 connectors.
- d) Remove the 4 screws and then lift the oven valve.

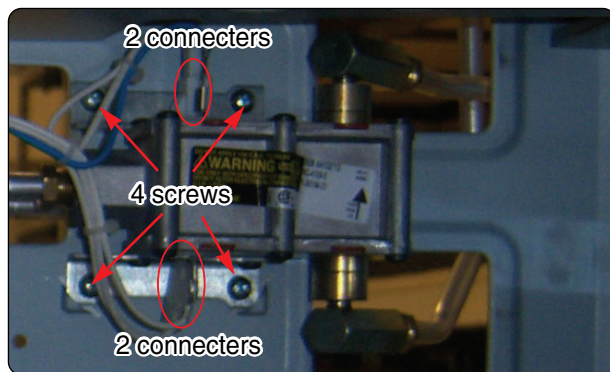

4. To remove the gas regulator:
 - a) Remove the 2 fittings and a gas supplier fitting.

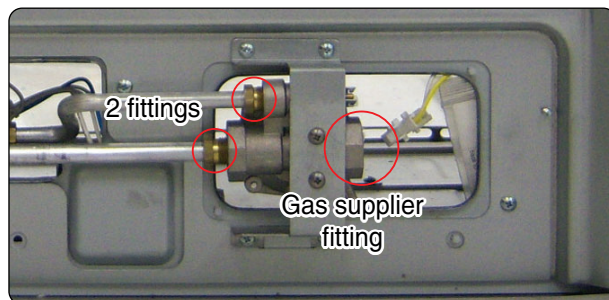

COMPONENT TEST

Before testing any of components, perform the following checks:

NOTE:

1. The most common cause for control failure is corrosion on connectors.
Therefore, disconnecting and reconnecting wires will be necessary throughout test procedures
2. ALL units in the first few days of use should be checked for mis-wiring or loose connections





1. All/tests/checks should be made with a VOM or DVM having a sensitivity of 20,000 ohms per-volt DC, or greater.
2. Check all connections before replacing components, looking for broken or loose wires, Failed terminals, or wires not pressed into connectors far enough.
3. Resistance checks must be made with power cord unplugged from outlet, and with wiring harness or connectors disconnected.

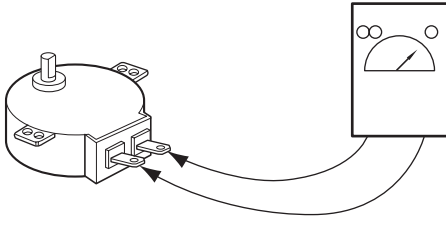

WARNING

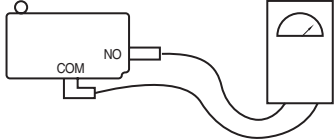
- Turn off the electrical supply and gas supply going to the range.
- Replace all panels and parts before operating
- Reconnect all grounding devices after servicing
- Failure to do so can result in death or electrical shock

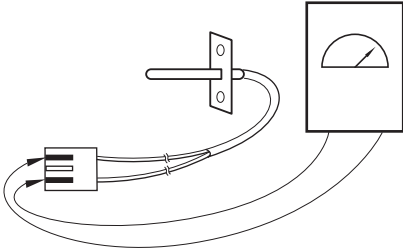
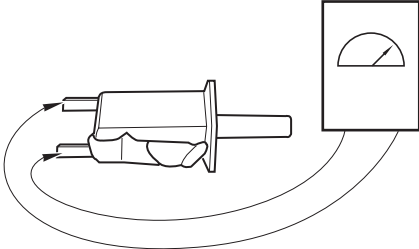
NOTE: Below Ω value were tested at room temperature (77F/25°C)

Components	Test procedures	Results
Door locking Motor	<ol style="list-style-type: none"> 1. Refer to page 3-13 for the servicing procedure 2. Measure the resistance (Multiple meter scale: R x 1000) 	<p>Normal: Approximately 2.6 kΩ \pm 10% If not replace</p> <p>Abnormal: Infinite(open) below 5Ω (shorted)</p>

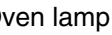
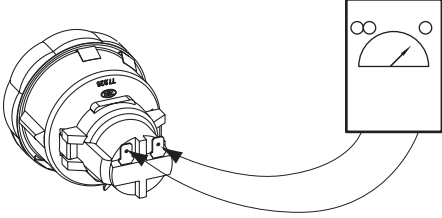
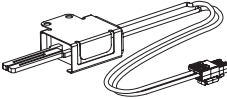
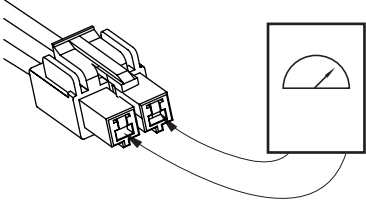
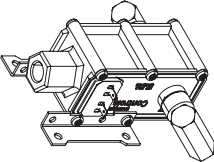
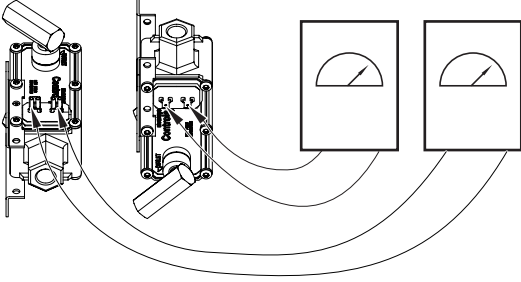
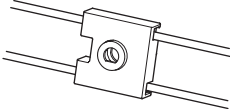
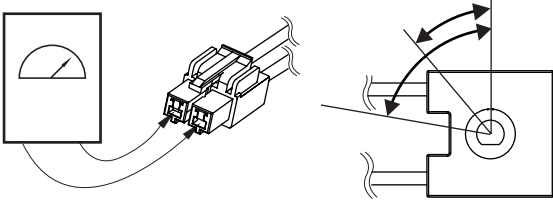
Components	Test procedures	Results		
Micro Switch (normally open type)	1. Refer to page 3-13 for the servicing procedure 2. Measure the resistance (Multiple meter scale: R x 1000) 	Door latch open	Door latch Locked	
	NOTE: After checking for the continuity of switch, make sure that they are connected correctly			 Continuity
Oven Sensor	1. Refer to page 3-14 for the servicing procedure 2. Measure the resistance after cooling down (Multiple meter scale: R x 1000) 	Normal: Approximately 1.09 kΩ ± 10% If not replace NOTE: Ω Value was tested at room temperature (77F/25°C)		
	NOTE: Oven sensor is so sensitive to temperature Do test after cooling down sufficiently			
Door switch	1. Refer to page 3-8 for the servicing procedure 2. Measure the resistance after cooling down (Multiple meter scale: R x 1) 	Door open	Door closed	
			 Continuity	 Infinite

Components	Test procedures	Results	
Oven lamp 	1. Measure the resistance after cooling down (Multiple meter scale: R x1) 	Normal: Approximately $5 \Omega \pm 10\%$ If not replace	
Broil or bake igniter 	1. Refer to page 3-9 or 3-10 for servicing procedure. 2. Measure the resistance after cooling down. (Multiple meter scale : R x 1) 	Normal: $45 \Omega \sim 100 \Omega$ (Room Temperature Resistance) If not replace	
Oven (safety) valve 	1. Refer to page 3-21 for servicing procedure. 2. Measure the resistance after cooling down. (Multiple meter scale : R x 1) Upside Downside 	Normal: Approximately $1 \sim 3 \Omega$ If not replace	
Ignition switch 	1. Refer to page 3-21 for servicing procedure. 2. Measure the resistance by rotating the cam of each switch slowly. (Multiple meter scale : R x 1) 	approximately $40^\circ \sim 80^\circ$	other
		 Continuity	 Infinite

CONVERSION TO LP GAS

⚠ WARNING

- Turn off the electrical supply and gas supply going to the range.
- Replace all panels and parts before operating.
- **RECONNECT** all grounding devices.
 - Failure to do so can result in severe personal injury, death or electrical shock.

⚠ CAUTION

- Be careful when you work on the gas range handling the sheet metal part.
 - Sharp edge may be present and you can cut yourself.

Tools required

- Adjustable wrench
- 13/32" or 10mm open-end wrench
- Phillips head screwdriver
- Flat bladed screwdriver(blade width approximately 3/32" across)
- Nut drivers : 13/32" or 10mm

1. PREPARE RANGE FOR CONVERSION

- 1) Turn off gas supply to the range.
- 2) Turn off the electrical power to the range.

⚠ CAUTION

- If the gas supply to the range is disconnected for any reason see the installation instructions for proper connection and safety precautions.

2. CONVERT THE PRESSURE REGULATOR

⚠ WARNING

- Do not remove the pressure regulator from the range.

Remove the storage drawer and the pressure regulator is located at the rear of the range.

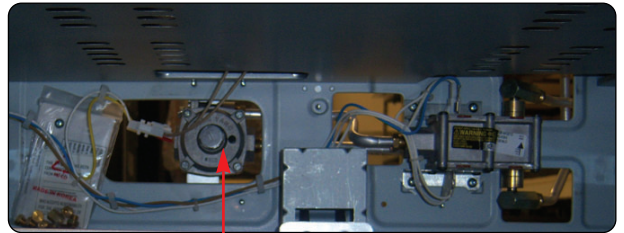

Pressure regulator

3. CONVERTING YOUR REGULATOR

- 1) Unscrew the hex-nut cap by using an adjustable wrench.
- 2) Separate plastic cap and hex-nut cap by turning the plastic cap to 90°.
- 3) Assemble plastic cap in the opposite side.
- 4) Screw the hex-nut cap back into the regulator.
Do not over tighten.

LPG



Natural

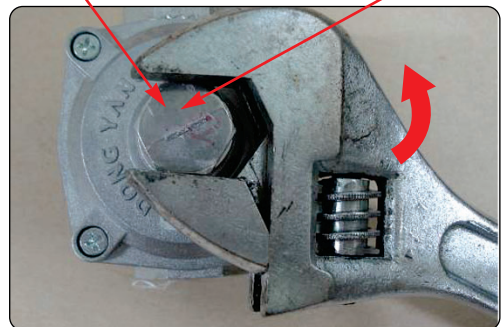

CONVERSION TO LP GAS

⚠ WARNING

- Turn off the electrical supply and gas supply going to the range.
- Replace all panels and parts before operating.
- RECONNECT all grounding devices.
 - Failure to do so can result in severe personal injury, death or electrical shock.

⚠ CAUTION

- Be careful when you work on the gas range handling the sheet metal part.
 - Sharp edge may be present and you can cut yourself.

- 1) Remove grates, burner caps and burner heads.
- 2) Remove the brass orifice spud in the chimney of each burner using a 13/32" or 10 mm nut driver.
- 3) Install the LP orifice spuds into their correct positions as described previously.

BURNER OUTPUT RATINGS; BTU/HR					
LP (Propane) Gas, 10" W.C.P					
BURNER	MODEL	BTU RATE		ORIFICE CODE	
		LRG3097S	LRG3095S	LRG3097S	LRG3095S
LF		9,500	9,500	L	L
LR		9,100	9,100	M	M
RR		5,000	5,000	P	P
RF	INNER	15,000	10,000	K	Q
	OUTER			J	
CTR		8,000	8,000	R	R
BROIL		14,000	14,000	C	C
BAKE		18,000	18,000	D	D

4. CONVERTING THE SURFACE BURNERS

Remove the conversion kit (see illustration below).

LP orifice spuds have a orifice code on the top or the side, denoting the location on the range where it is to be installed.

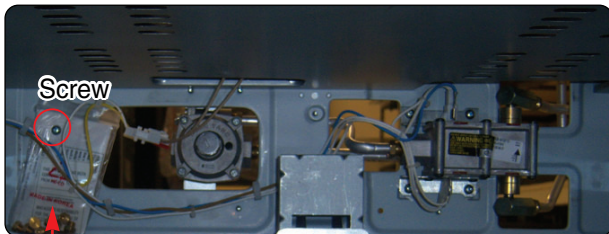

Conversion Kit

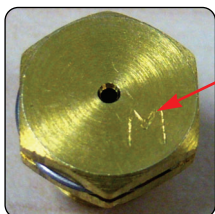

Top burner orifices

Denotes orifice code

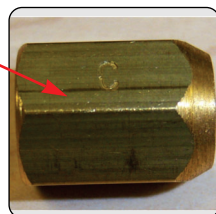

Broil and Bake burner orifices

Orifice Locations for LP Gas [LRG3097S]

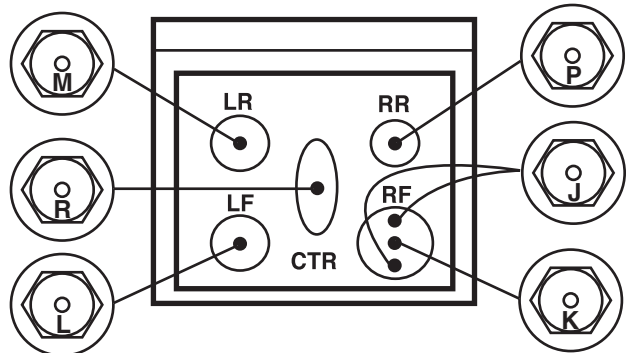

Orifice Locations for LP Gas [LRG3095S]

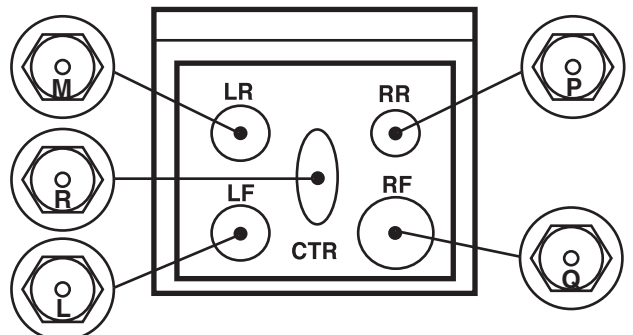

CONVERSION TO LP GAS

WARNING

- Turn off the electrical supply and gas supply going to the range.
- Replace all panels and parts before operating.
- **RECONNECT** all grounding devices.
 - Failure to do so can result in severe personal injury, death or electrical shock.

CAUTION

- Be careful when you work on the gas range handling the sheet metal part.
 - Sharp edge may be present and you can cut yourself.

BURNER OUTPUT RATINGS; BTU/HR				
Natural Gas, 5" W.C.P				
MODEL	BTU RATE		ORIFICE CODE	
	LRG3097S	LRG3095S	LRG3097S	LRG3095S
LF	12,000	12,000	C	C
LR	9,100	9,100	D	D
RR	5,000	5,000	G	G
RF	INNER	17,000	B	H
	OUTER		A	
CTR	8,000	8,000	I	I
BROIL	15,500	15,500	A	A
BAKE	18,000	18,000	B	B

Orifice Locations for Natural Gas [LRG3097S]

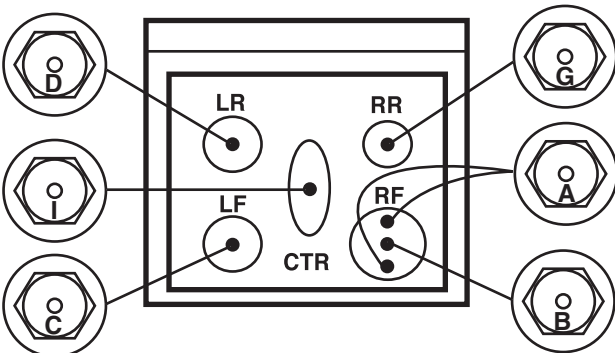

Orifice Locations for Natural Gas [LRG3095S]

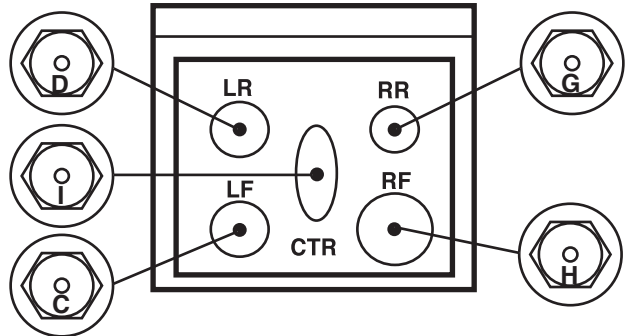

- 4) To prevent leakage, make sure the orifice spuds are securely screwed into the gas supply tubes.
- 5) For the extra burner (right front) of LRG3097S, three orifice spuds will be needed.
- 6) For the right front burner of LRG3095S, the choke and self threading screw will be needed as shown Fig. Insert the choke into the burner base, then insert the set screw into the burner base and tighten securely. Make sure the screw head is against the shoulder (within choke notch), so it does not have any rotational movement.

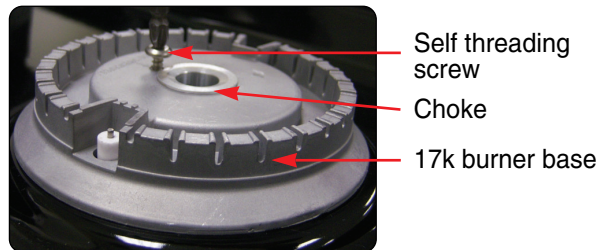

<Fig>

- 7) Put the old orifice spuds into conversion kits and place back on the range for possible future conversion.

NOTE: If an orifice spud is accidentally dropped, the cooktop plate can be raised (see the page 3-4)

CONVERSION TO LP GAS

⚠ WARNING

- Turn off the electrical supply and gas supply going to the range.
- Replace all panels and parts before operating.
- RECONNECT all grounding devices.
 - Failure to do so can result in severe personal injury, death or electrical shock.

⚠ CAUTION

- Be careful when you work on the gas range handling the sheet metal part.
 - Sharp edge may be present and you can cut yourself.

5. CONVERT THE OVEN BURNER ORIFICES

- 1) OVEN LOWER BURNER(BAKE)
 - a) Remove oven door, oven bottom, frame guide, nozzle case and oven burner assembly (See the page 3-10).
 - b) Remove the orifice spud from nozzle holder using a 13/32" or 10mm wrench.
 - c) Install the LP orifice spud(D) to the nozzle holder. To prevent leakage, make sure the orifice spud is securely screwed into the nozzle holder.

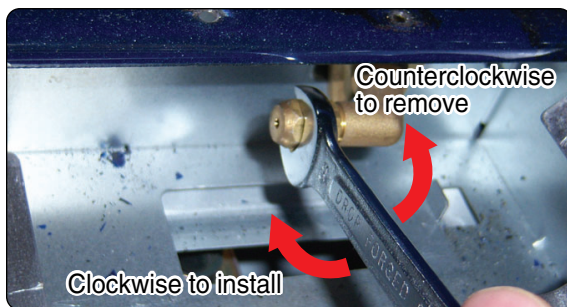

2) OVEN UPPER BURNER(BROIL)

- 1) Remove oven door and Broil burner assembly. Then remove the wire cover using a phillips head screwdriver (See the page 3-11).

- 2) Release the connector of the igniter.
- 3) Remove the orifice spud from nozzle holder using a 13/32" or 10mm wrench.
- 4) Install the LP orifice spud(C) to the nozzle holder. To prevent leakage, make sure the orifice spud is securely screwed into the nozzle holder.

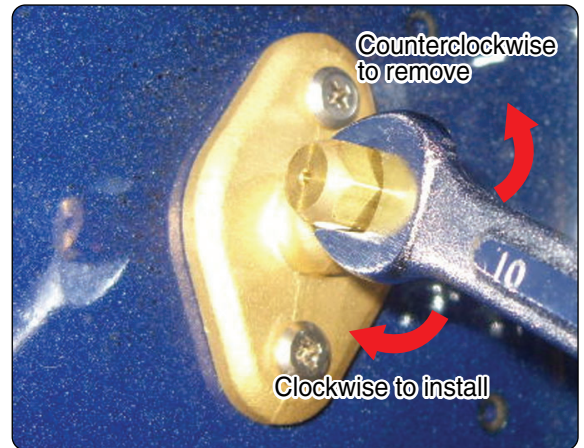

6. Turn on the Electrical and Gas Supply to continue with flame adjustment.

7. ADJUSTING THE AIR SHUTTER

For bake burner, adjust the Air Shutter for LP gas, loosen the Philips head screw and rotate the shutter to the fully open position as shown Fig.1.

NOTE: When converting the unit back to natural gas the bake burners air shutter should be also in fully open position.

For broil burner, adjust the Air Shutter for LP gas, loosen the Philips head screw and rotate the air shutter until the opening appears to be 1/2 closed. (Refer to Fig.2).

NOTE: When converting the unit back to natural gas the broil burners air shutter should be in fully open position.

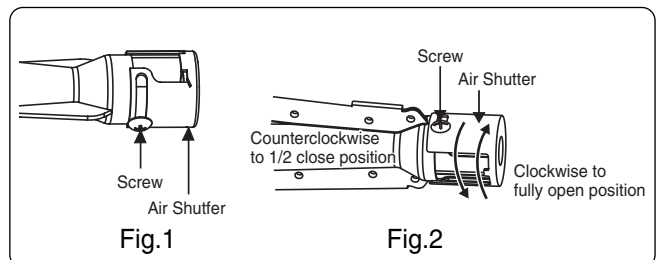

CONVERSION TO LP GAS

WARNING

- Turn off the electrical supply and gas supply going to the range.
- Replace all panels and parts before operating.
- RECONNECT all grounding devices.
 - Failure to do so can result in severe personal injury, death or electrical shock.

CAUTION

- Be careful when you work on the gas range handling the sheet metal part.
 - Sharp edge may be present and you can cut yourself.

8. CHECK QUALITY OF THE FLAMES

The combustion quality of the burner flames needs to be determined visually.

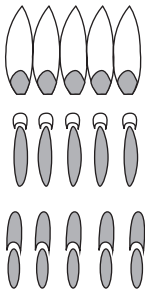

- A. Yellow Flames:**
Further Adjustment Required
- B. Yellow tips on outer cones:**
Normal for LP Gas
- C. Soft Blue flames:**
Normal for Natural Gas.

NOTE: If burner flames look like A Further air shutter adjustment is required. B or C is normal burner flames, depending on the type of gas you use. With LP gas, some yellow tipping on the outer cones is normal.

9. ADJUST THE SURFACE BURNER LOW FLAME(SIMMER) SETTING.

- 1) Light all surface burners.
- 2) Turn the knob on the burner being adjusted to "LO"
- 3) Remove knob.

- 4) Insert a small, flat bladed screwdriver into the valve shaft as shown in Fig. 1.
Turn the adjustment screw until the flame reaches the desired size.
- 5) Replace the knob.



Center adjustment screw

Fig.1

- 6) Test the flame stability.

Test 1: Turn the knob from "HI" to "LOW" quickly. If the flame goes out, increase the flame size and test again.

Test 2: With the burner on a "LOW" setting, open and close the oven door quickly. If the flame is extinguished by the air currents created by the door movement, increase the flame height and test again.

- 7) Repeat steps 1-5 for each surface burner.

10. CONVERSION STICKER

Upon completion of the conversion, fill out the LP sticker located with the instructions. Once complete, attach the sticker to the back of the range near the regulator.

Place all orifice's that were removed for natural gas back into the plastic bag along with the instructions. Place the kit back into its original location.

CONVERSION IS FINISHED

To convert to the original gas.

Follow conversion process with original orifices to convert the appliance to the original gas.

NOTE: The choke for the 17k top burner must be removed when converting the range back to natural gas.

COMPOSITION OF CONTROL

Main PCB (P/N : EBR52349504)

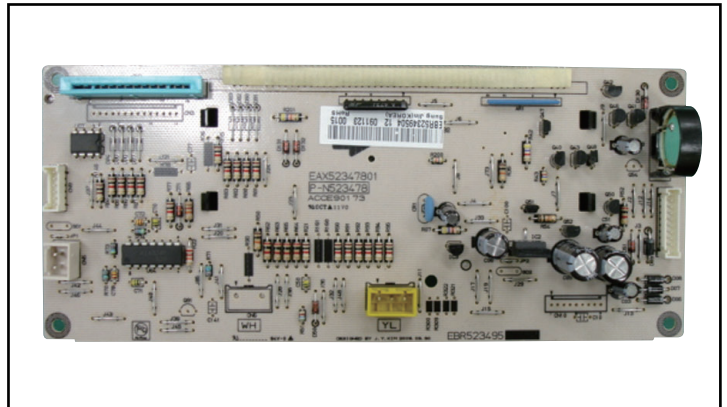

Power PCB (P/N : EBR57124701)

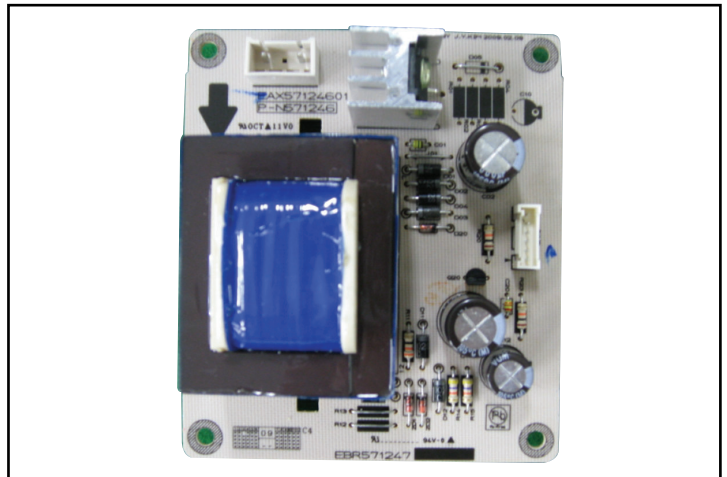

Relay PCB (P/N : EBR52349703)

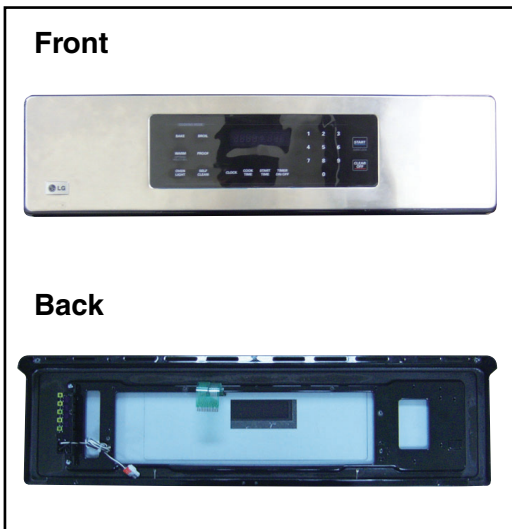
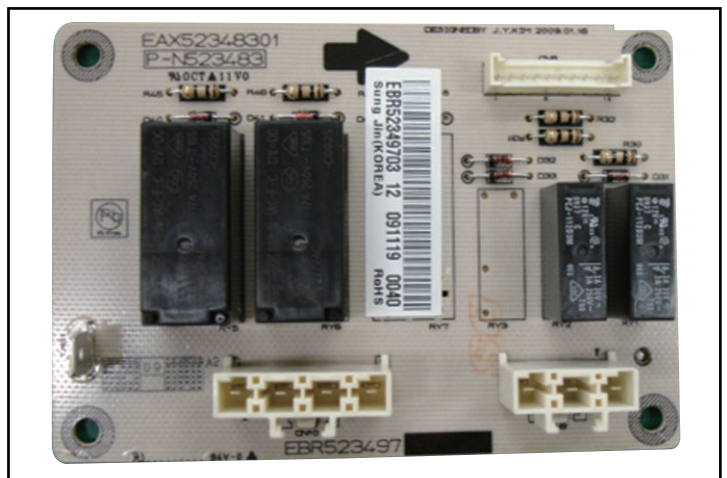

Controller assembly

COMPOSITION OF CONTROL

Main PCB

P/N : EBR52349504

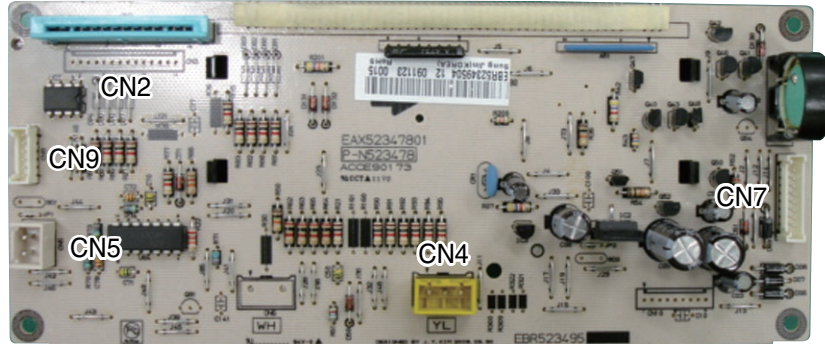

Power PCB

P/N : EBR57124701

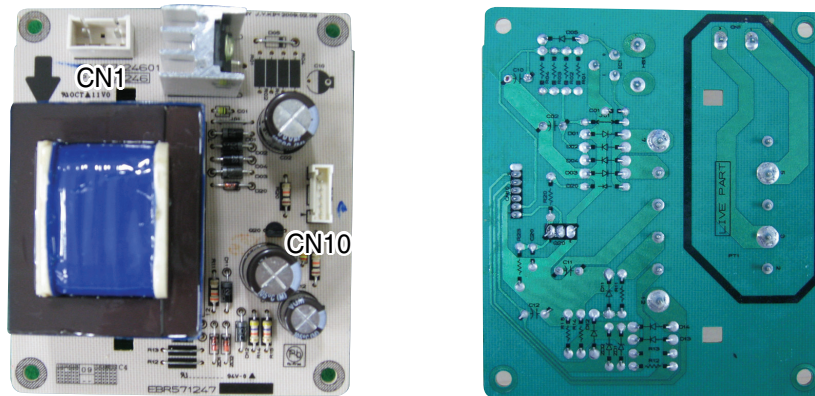

Relay PCB

P/N : EBR52349703

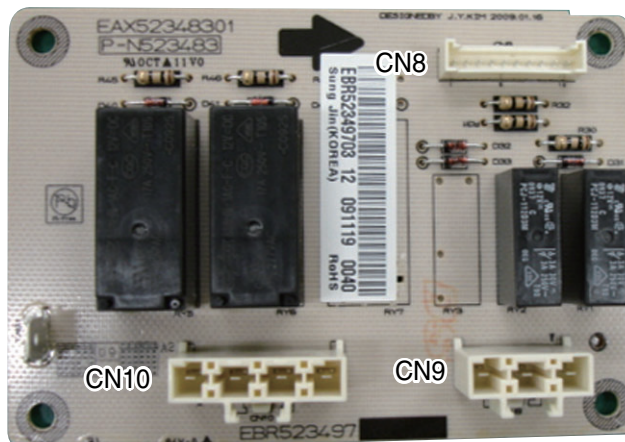

DIAGNOSIS THROUGH SCHEMATIC

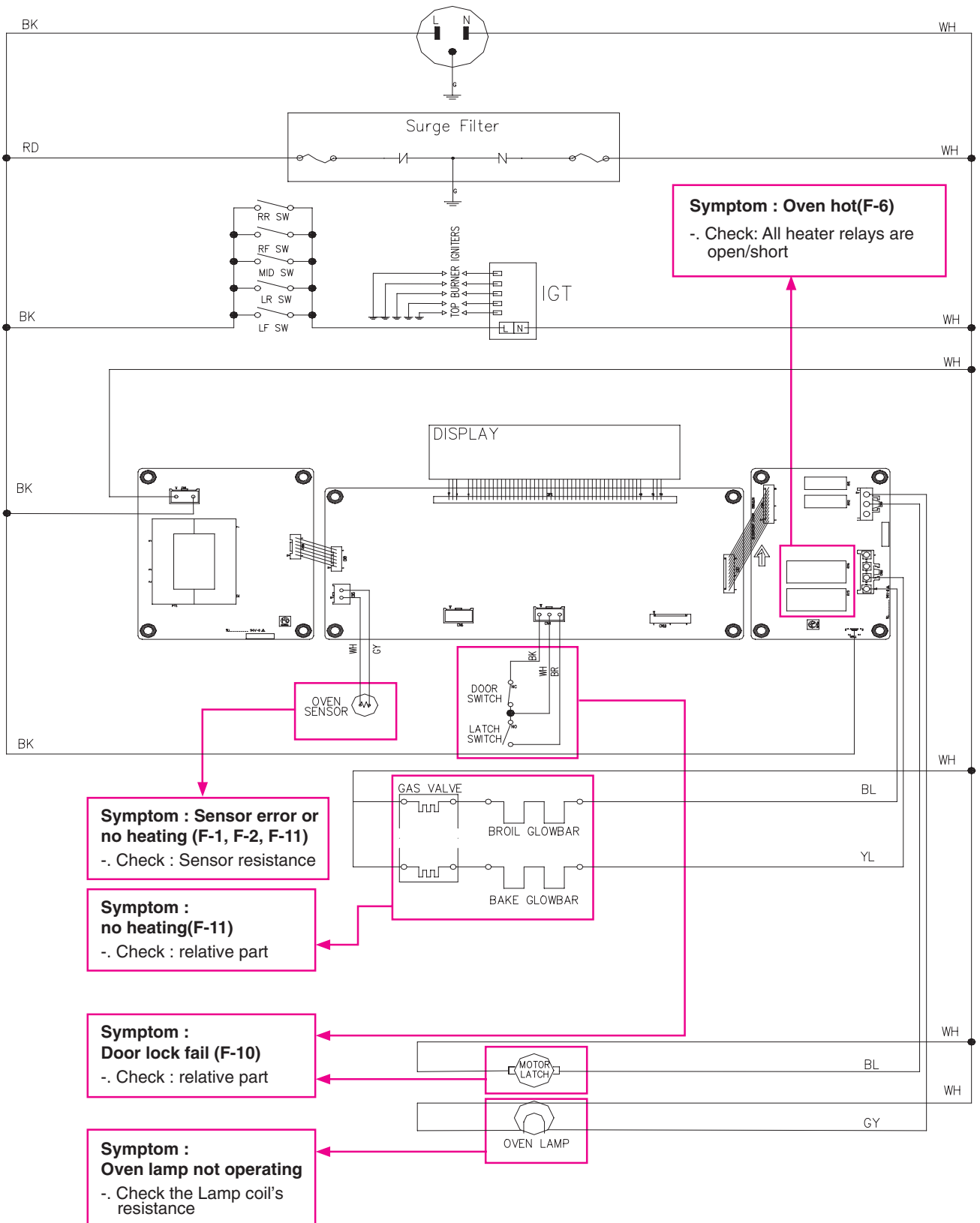

CHECK THE FAILURE CODE (F-code)

■ When the oven has some failure on cooking,

- Cancel the cook.
- In case of failure, F-code will not display during normal operation.
- It memorizes F-code logs in EEPROM.

■ Check the failure code as follow these steps.

1. Press the “clear” key
2. Press the “BAKE” and “BROIL” key at the same time

If the oven has some failure, the Oven will show the failure Code, like FIG. 1

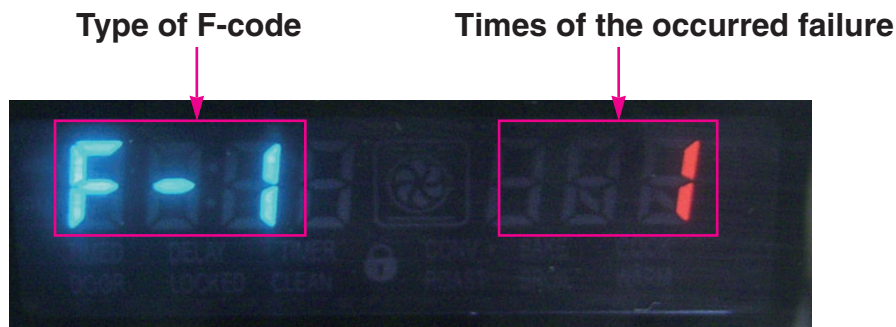

< FIG. 1 >

If the oven do not has any failure, the Oven will show it like FIG. 2



< FIG. 2 >

NOTE:

After checking for the F code, press the “CLEAR” key to remove all codes.

FAILURE CODE SUMMARY

Code	Description	How to detect	Check point
F-1	Opened Sensor	Oven sensor remains open over 1 min during cooking.	1. Wiring 2. Oven Sensor
F-2	Shorted Sensor	Oven sensor is short over 1 min during cooking.	1. Wiring 2. Oven Sensor
F-3	Key shorted Error	When some key is continuously short over 60 seconds. (except oven temp is over 500°F)	1. Wiring 2. KeyPad(in case of Key Pad Model)
F-6	Oven hot	The oven temperature is over 650°F continuously during 2 minutes on cooking except self cleaning.	Oven Sensor
F-10	Door Lock Fail	In case of Door Lock Failure in operating Lock motor.	1. Electric Wiring 2. Motor's Resistance 3. Micro Switch
F-11	No heating	If start oven temperature does not exceed 130°F and oven temperature is less equal than start temperature over 5 minutes on preheating, where door is closed.	1. Gas supply & gas regulator 2. Electric Wiring 3. Gas Valve 4. Oven igniter 5. Oven Sensor

CHECKING FLOW CHART BY FAILURE

Symptom	Check Point
1. Power Failure (Dead) 2. No Display	1. Check Electric Wiring 2. Check the Power PCB and Main PCB Voltage

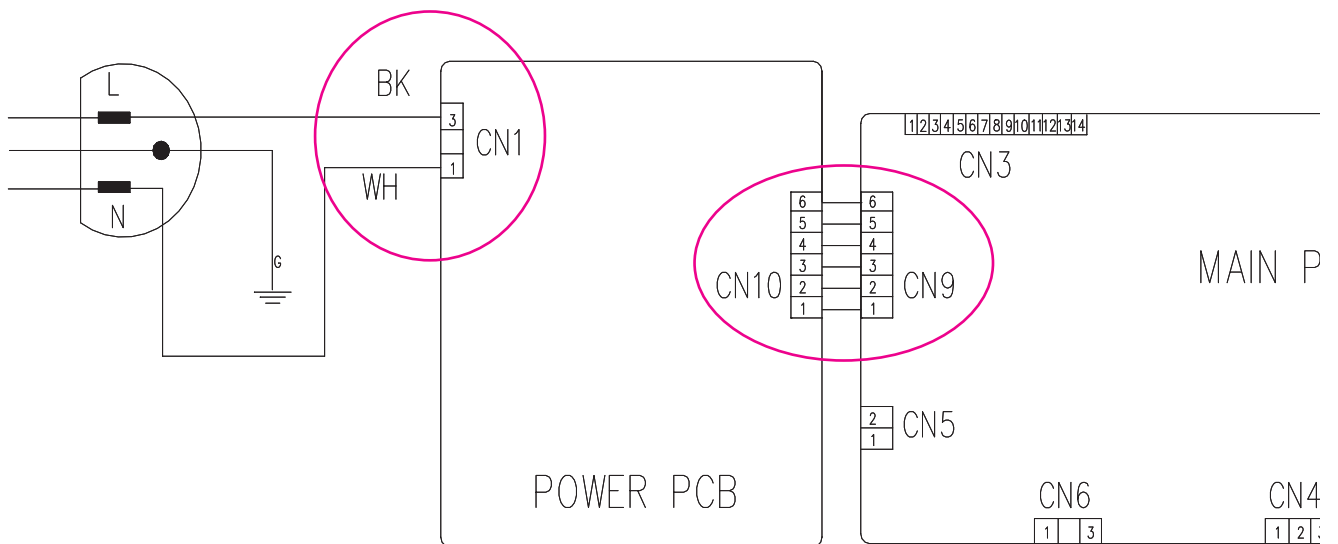

CHECKING FLOW CHART BY FAILURE

Power Failed(Dead),
No display?

Yes

Power On State

1

Check the key beep.
Touch the "clear key",
Is the beep sound?

Yes

Go to No 4

No

Power Off State

2

Is the connector connected
to Power PCB disconnected
or disassembled? (CN1),
between Power PCB (CN10)
and display PCB(CN9)

Yes

Reconnect or
repair the
connector

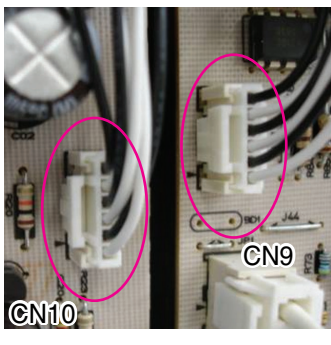
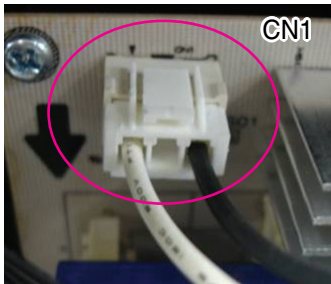

No

Power Off

3

Is the electric wiring normal?

No

Replace the
defective
harness

Measure the resistance
Power cord and CN01's
connection

Normal : continuity
Abnormal : infinite

- Code L to Pin3 of CN01(BK)
- Code N to Pin1 of CN01(WH)

BK color is L.

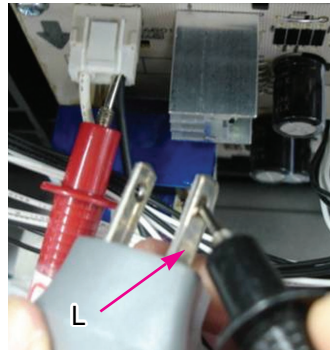

White color is N

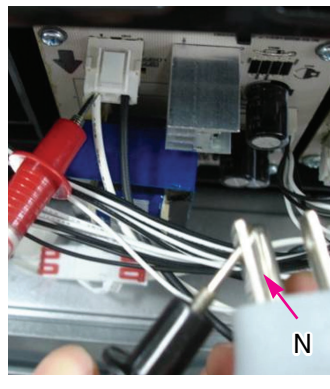

Yes

Normal	Abnormal
<p>Continuity</p>	<p>Infinite</p>

CHECKING FLOW CHART BY FAILURE

Power On

4

Check the voltage of Power PCB
Is the voltage as below?

No → Replace the Power PCB

PIN No. of CN10	Voltage
PIN2 ~ PIN3(GND)	approximately 14.5 ~ 15.5[V]
PIN4 ~ PIN3(GND)	approximately -24 ~ -35[V]
PIN5 ~ PIN6	approximately AC 3.4 ~ 4.6 [V]

CN10

Yes

Power On

5

Is the voltage of Main PCB's Vcc 4.5V ~ 5.5V?
Check the voltage between pin2 and pin3 of IC2

No → Replace the Main PCB

6

Check the voltage of Main PCB
Is the voltage as below?

No → Replace the harness (CN9 to CN10)

PIN No. of CN9	Voltage
PIN4 ~ PIN3(GND)	approximately -24 ~ -35[V]
PIN5 ~ PIN6	approximately AC 3.4~ 4.6 [V]

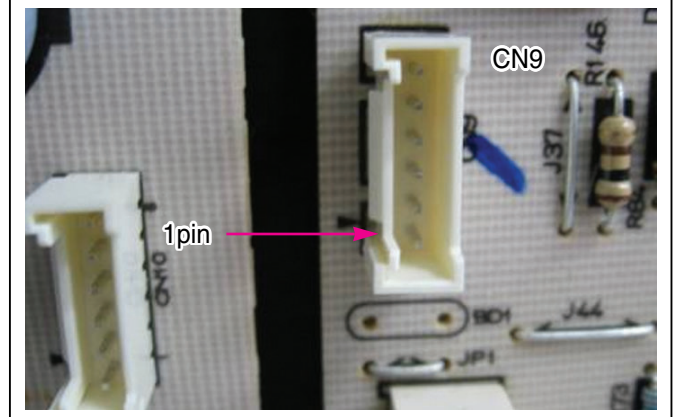

Yes

Replace the Main PCB

CHECKING FLOW CHART BY FAILURE

Symptom	Check Point
1. No heating 2. F11	1. Check Gas Supply 2. Check Electric Wiring 3. Check Heater's Resistance. 4. Check the Sensor.

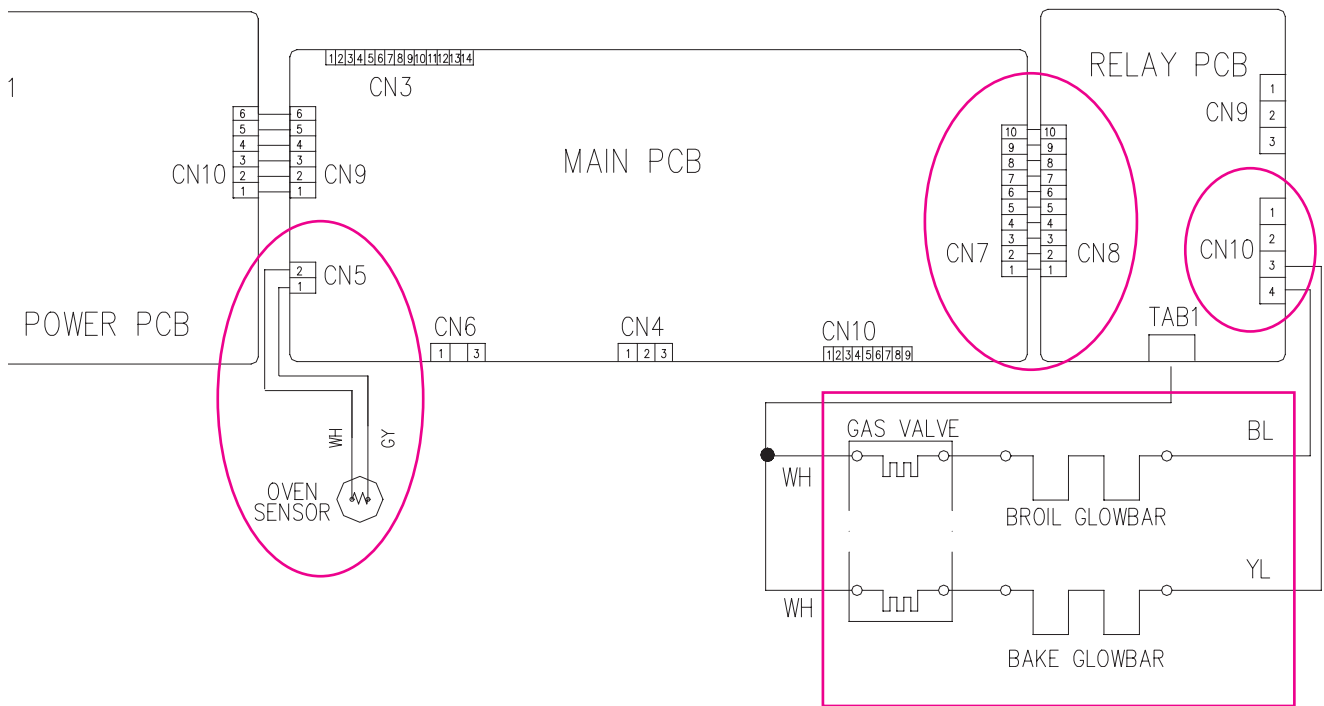

CHECKING FLOW CHART BY FAILURE

Oven does not heat, F-11

Yes

Power Off

1

Is the disconnect or loose connector?

Yes

Reconnect or repair the connector

1. Between Main PCB and Relay PCB (CN7, CN8)
2. Electric wiring of relay PCB (CN10)
3. Electric wiring of electric element

CN8

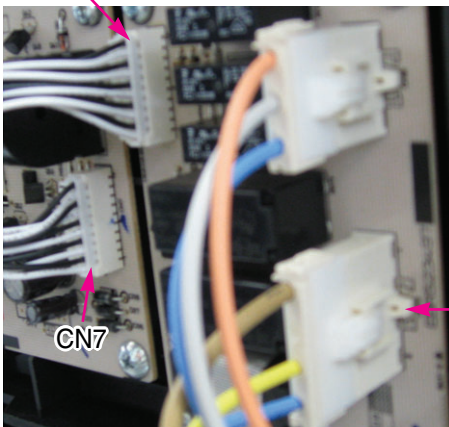

CN10

Gas Valve & Drawer Heater

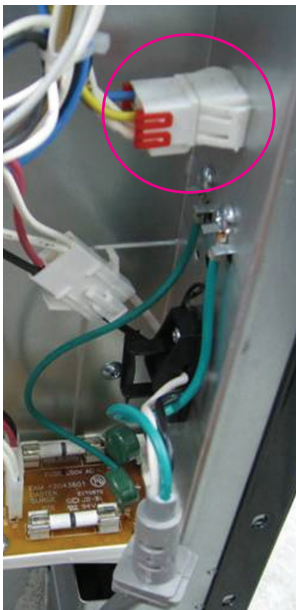

Broil glowbar igniter

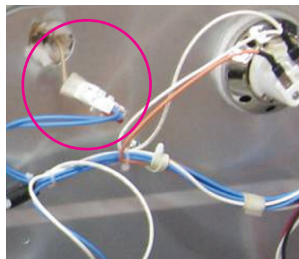

Bake glowbar igniter

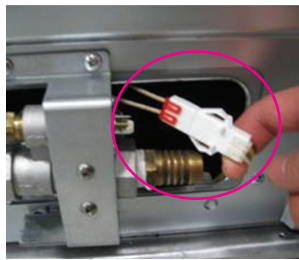

No

Power Off

2

Is the glowbar igniter normal?

No

Replace the failed glowbar

Measure the resistance of each glowbar
(The resistance is shown on next page)

Broil glowbar igniter



Bake glowbar igniter



Yes

Power Off

3

Is the Gas valve normal?

No

Replace the Failed Valve

Measure the resistance of Gas valve
(The resistance is shown on next page)

Broil Gas Valve

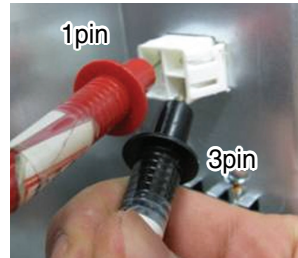

Bake Gas Valve

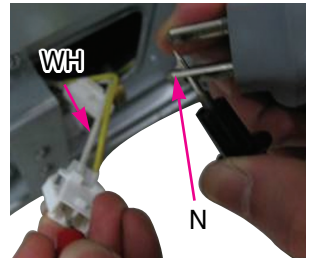

Pin No.

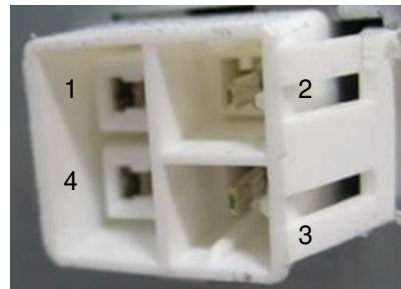

CHECKING FLOW CHART BY FAILURE

Range Of the resistance

Heater	Min[Ω]	Max [Ω]
Broil Glowbar	45.0	400.0
Bake Glowbar	45.0	400.0
Gas Valve(Broil)	1	1.5
Gas Valve(Bake)	1	1.5

Yes

Power On

4

Is the value of thermistor normal?

Check: using the test mode

Yes

Go to No 6

To enter the test mode, follow these steps:

1. press the "CLEAR" key
2. press the "BAKE", "BROIL" key at the same time



3. press the "BAKE", "BROIL" key at the same time again.



4. press the NUM "3" key



Normal : the sensor value is from 70°F to 90°F at 25°C.

No

Power Off

5

Is the resistance of thermistor normal?

No

Replace the failed thermistor

Check:

Pins 1 and 2 of CN5 wiring in main PCB

Normal - approximately 1.09kΩ at 25°C

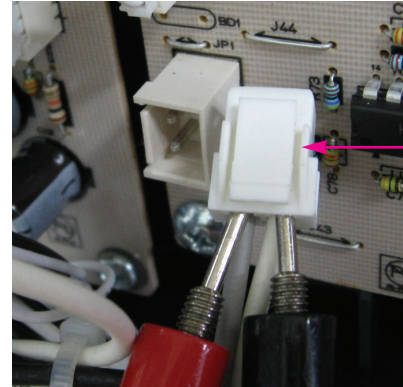

CN5

Yes

6

Replace the Relay PCB (EBR52349703)

If it doesn't work even though changing the Relay PCB, you should replace the Main PCB.(EBR52349504)

CHECKING FLOW CHART BY FAILURE

Symptom	Check Point
1. Door Lock System Failure 2. F-10	1. Check the Electric wiring 2. Check the Motor's Resistance 3. Check the Relay PCB(Lock Motor Relay)

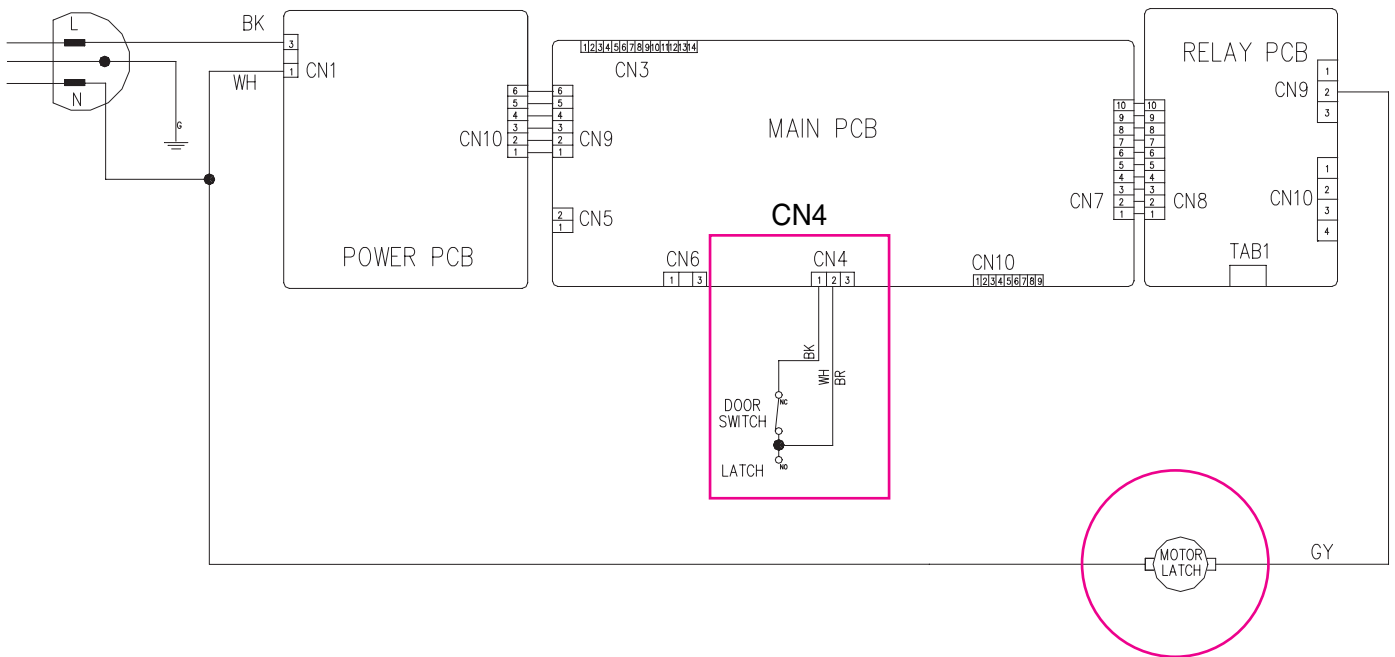

CHECKING FLOW CHART BY FAILURE

Door Lock System Failure, F-10?

Yes

Note :

Just after self-clean start, the door lock motor starts to rotate.
During that time if the door lock switch does not operate properly after rotating twice, then supervising circuit detects a Door Lock failure and the F-10 error code appears.

Power Off

1

Is the disconnect or loose connector?

Yes

Reconnect or repair the connector

1. Between Main PCB and Relay PCB (CN7, CN8)
2. Electric wiring of relay PCB (CN9)
3. Electric wiring of Locking Motor and Micro Switch
4. Electric wiring of CN4 of Main PCB

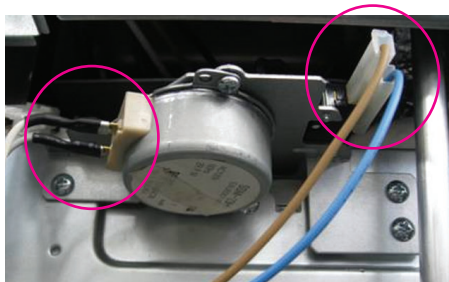
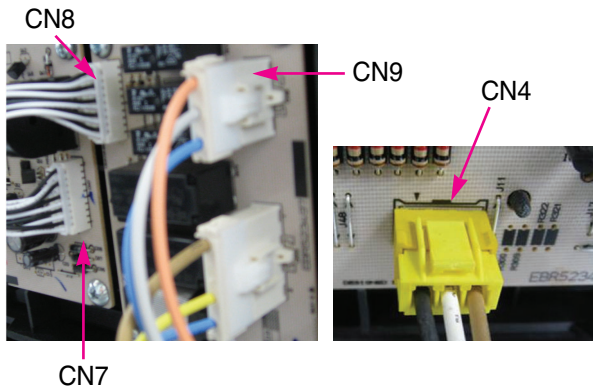

No

Power Off

2

Is the door lock switch (micro switch) normal?

No

Replace the micro switch

measure the resistance of door lock switch → normally open type



Abnormal	Normal
Continuity	Infinite

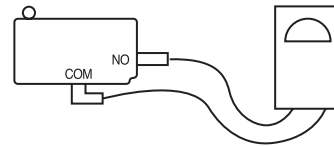

Yes

Power Off

3

Is the resistance of the locking motor normal?

No

Replace the locking motor

measure the resistance of locking motor

Normal : approximately 2.6kΩ
Abnormal : infinite or below 5 Ω



Yes

Replace the Relay PCB (EBR52349703)

CHECKING FLOW CHART BY FAILURE

Symptom	Check Point
1. Sensing Fail 2. F-1 3. F-2	1. Check the Electric Wiring 2. Check the Test Mode 3. Check the Sensor's Resistance

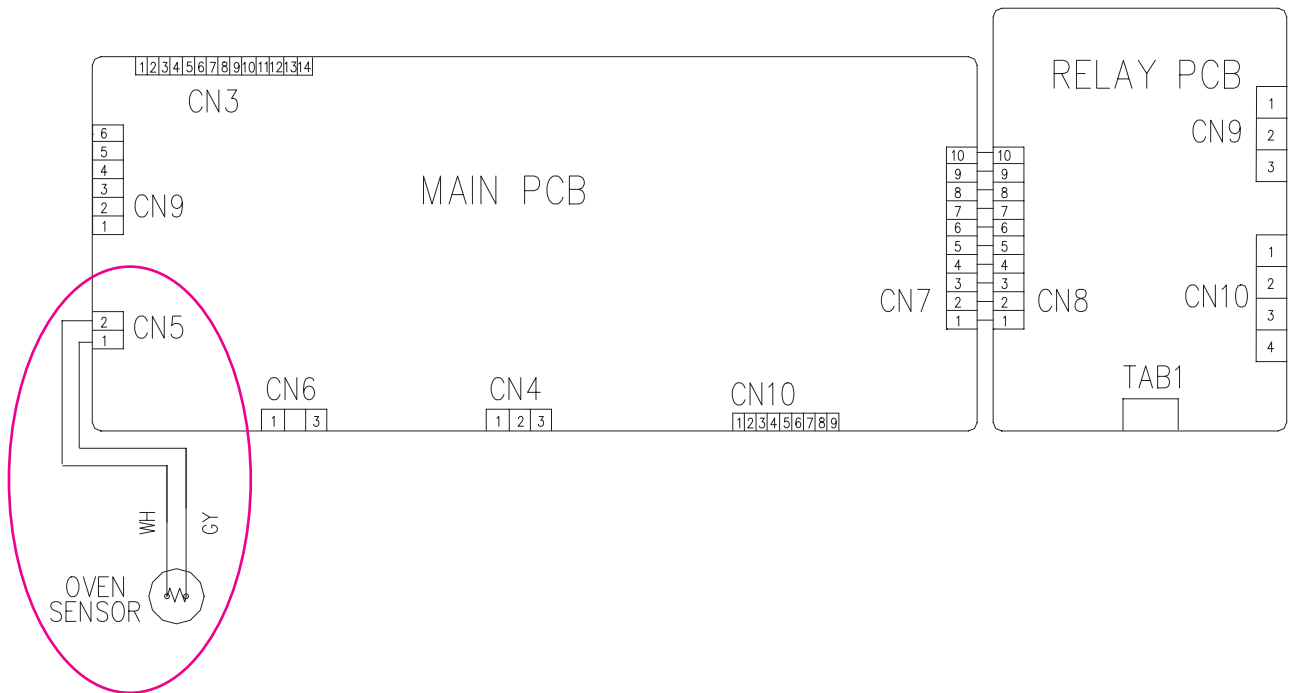

CHECKING FLOW CHART BY FAILURE

Sensing Fail, F-1, F-2?

Yes

Power Off

1

Is the disconnect or loose connector?

1. Sensor connection
2. CN05 of Main PCB

Yes

Reconnect or repair the connector

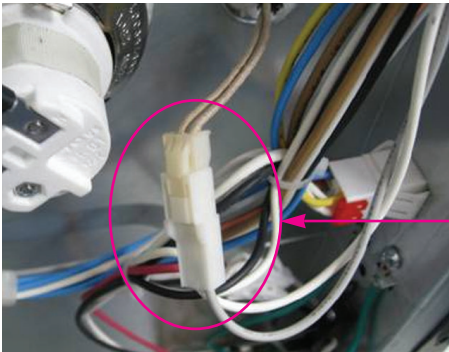

Sensor connection

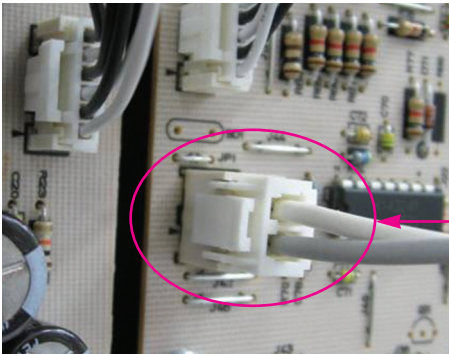

CN05 connection

No

Power Off

2

Is the resistance of thermistor normal?

Check:

Pins 1 and 2 of CN5 wiring in main PCB
Normal - approximately 1.09kΩ at 25°C

No

Replace the failed thermistor

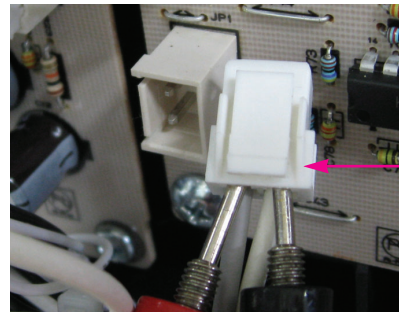

CN5

Yes

Power On

3

Is the value of thermistor normal?

Check: using the test mode

Yes

Go to No 1

To enter the testmode, follow these steps:

1. press the "clear" key
2. press the "BAKE", "BROIL" key at the same time

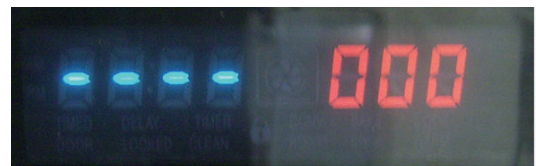

3. press the "BAKE", "BROIL" key at the same time again.



4. press the NUM "3" key

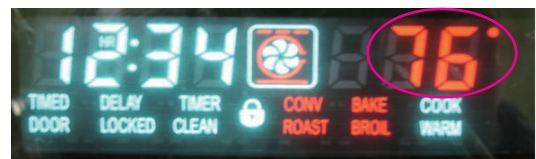

Normal : the sensor value is from 70°F to 90°F at 25°C.

No

4

Replace the Main PCB.
 (EBR52349504)

CHECKING FLOW CHART BY FAILURE

Symptom	Check Point
1. Oven hot 2. F-6	1. Check the Resistance of the Relay.

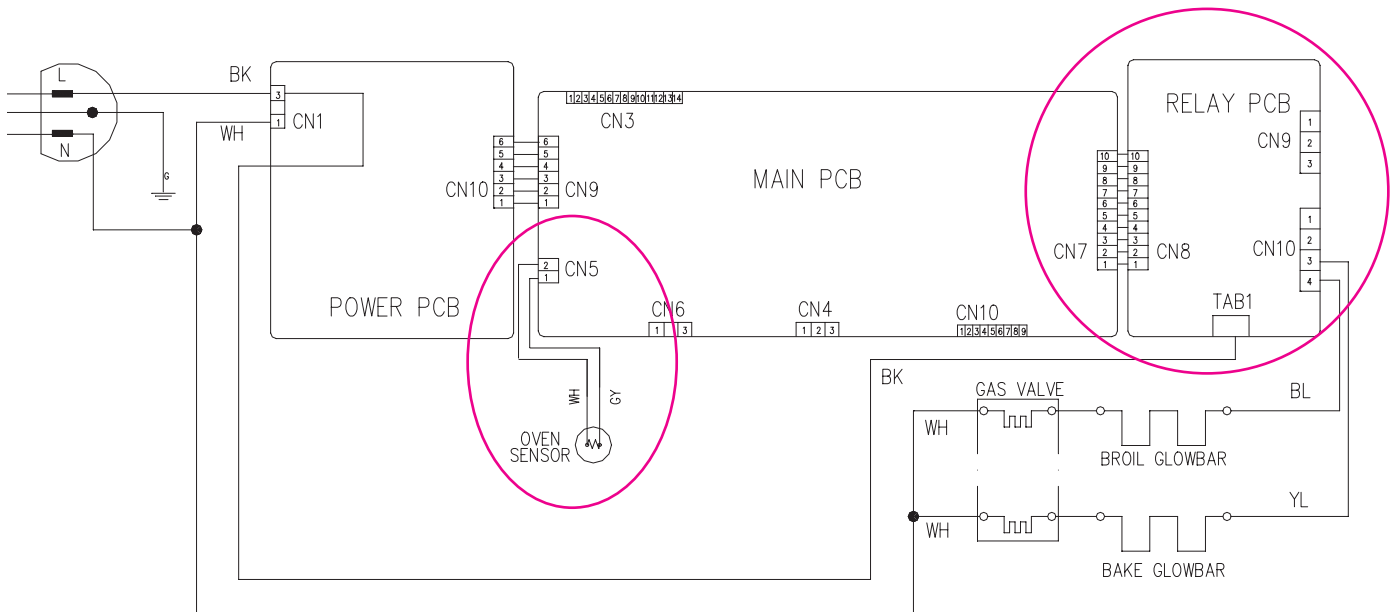

CHECKING FLOW CHART BY FAILURE

Oven too hot, F-6, F-16?

Yes

Power Off

1

Is the resistance of thermistor normal?

No

Replace the failed thermistor

Check:

Pins 1 and 2 of CN5 wiring in main PCB

Normal- approximately $1.09k\Omega$ / at $25^{\circ}C$

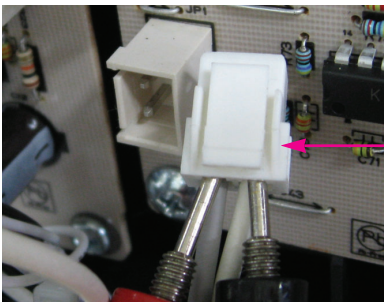

CN5

Yes

Power Off

2

Is the Heater relay normal?

No

Replace the relay PCB (EBR52349703)

Measure the resistance of heater relay and L.

Normal: infinite

Abnormal: continuity

Abnormal Normal

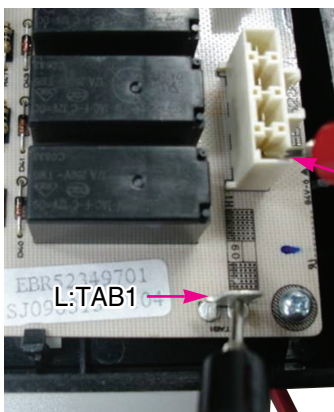
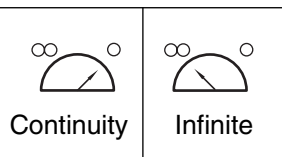

1pin(CN10)

Broil(RY5) Relay Resistance

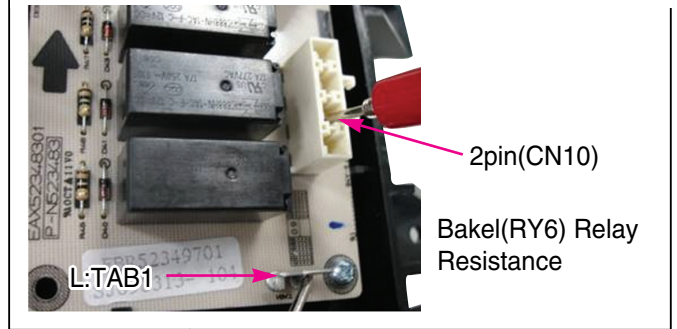

2pin(CN10)

Bakel(RY6) Relay Resistance

Yes

Power On

3

Is the value of thermistor normal?

No

Replace the Main PCB (EBR52349501 for LRG3097S, EBR52349502 for LRG3095S)

Check: using the test mode

To enter the testmode, follow these steps:

1. press the "clear" key
2. press the "BAKE", "BROIL" key at the same time



3. press the "BAKE", "BROIL" key at the same time again.



4. press the NUM "3" key

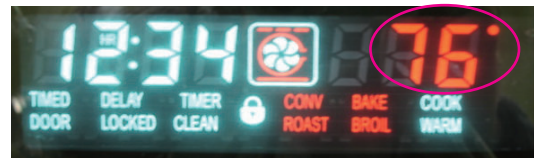

Normal : the sensor value is from $70^{\circ}F$ to $90^{\circ}F$ at $25^{\circ}C$.

Yes

CHECKING FLOW CHART BY FAILURE

Power On

4

Is the Relay operation signal Normal?
In Idle Mode (press the clear),
Check the voltage of Diode

No → Replace the Main PCB (EBR52349504)

→ 1. Both D40 ends.
2. Both D41 ends
2. Both D41 ends

Normal:
- approximately 0 V

Abnormal:
- approximately 9.6V~15.6V

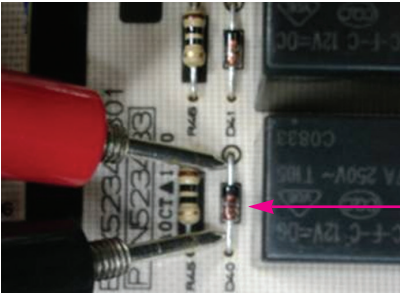

D40(Broil)

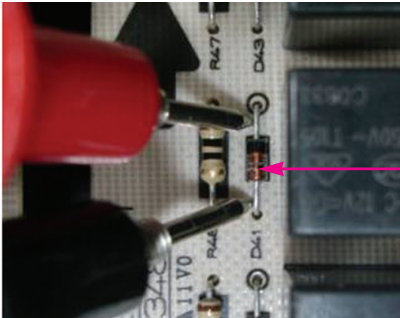

D40(Bake)

Yes ↓

5

Check the electric wiring connection.
It would be have wrong connection or electric wiring in defect.
Reconnect or replace the electric wiring.

CHECKING FLOW CHART BY FAILURE

Symptom	Check Point
1. Keypad Failure 2. F-3 Error	1. Check the Door Locking System. 2. Check the Electric Wiring.

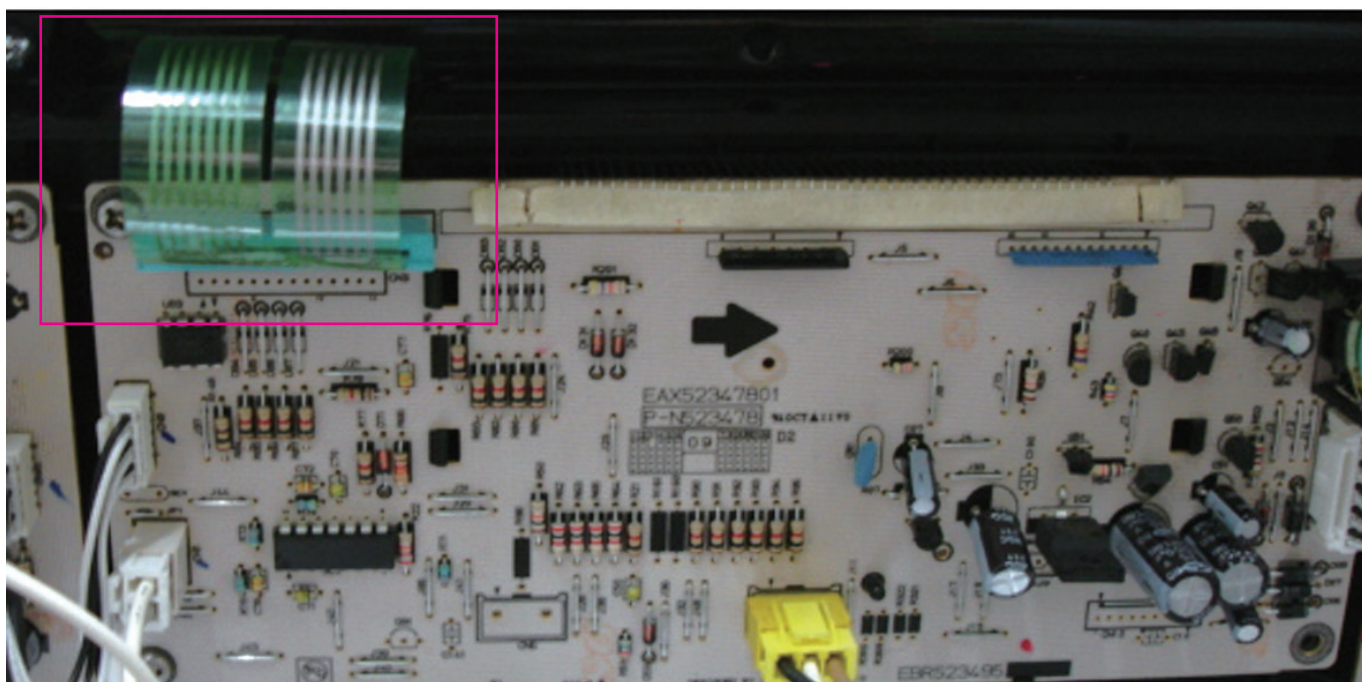

CHECKING FLOW CHART BY FAILURE

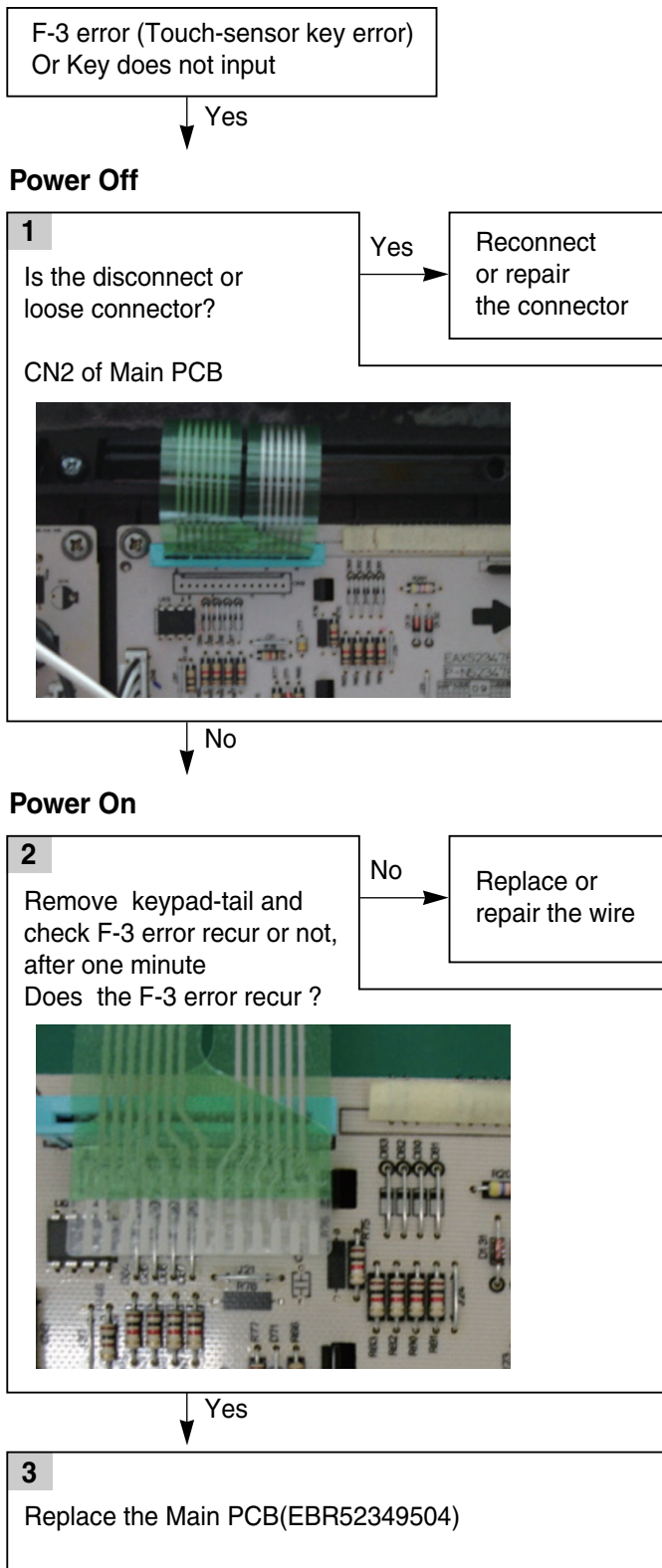

TROUBLE SHOOTING

BEFORE CALLING FOR SERVICE

Before you call for service, review this list. It may save you time and expense. The list includes common occurrences that are not the result of defective workmanship or materials in this appliance.

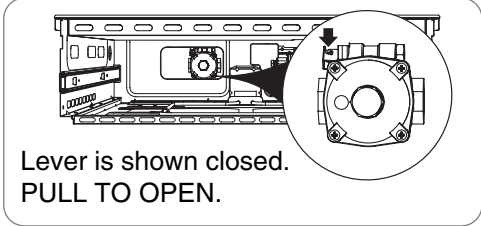
PROBLEMS	POSSIBLE CAUSES	SOLUTIONS
Range is not level	<ul style="list-style-type: none"> • Poor installation. • Poor floor. • Floor is sagging or sloping. • Kitchen cabinet alignment may make range appear unlevel. 	<ul style="list-style-type: none"> • Place oven rack in center of oven. Place a level on the oven rack. Adjust leveling legs at base of range until the oven rack is level. • Be sure floor is level and is strong and stable enough to adequately support range. • Contact a carpenter to correct the situation. • Be sure cabinets are square and have sufficient room for range clearance.
Top burners do not light or do not burn evenly	<ul style="list-style-type: none"> • The plug on range is not completely inserted in the electrical outlet. • Burner slits on the side of the burner may be clogged. • Improper burner assembly. 	<ul style="list-style-type: none"> • Make sure the electrical plug is inserted into a live, properly grounded outlet. • Remove the burners and clean them. Check the electrode area for burned-on food or grease. See the "CARE AND CLEANING OF THE RANGE" section in user's guide. • Make sure the burner parts are installed correctly. See the "CARE AND CLEANING OF THE RANGE" section in user's guide.
Burner flames very large or yellow	<ul style="list-style-type: none"> • Improper air to gas proportion. 	<ul style="list-style-type: none"> • If range is connected to LP gas, contact the technician who installed your range or made the conversion.
Surface burners light but the oven does not	<ul style="list-style-type: none"> • The oven gas shut-off valve may have accidentally been moved during cleaning or moving. 	<ul style="list-style-type: none"> • To check the oven gas shut-off valve, remove the warming drawer (see the "CARE AND CLEANING OF THE RANGE" section in user's guide.) and look for the gas shut-off lever at the back of the range. <div style="text-align: right;">  <p>Lever is shown closed. PULL TO OPEN.</p> </div>

TROUBLE SHOOTING

PROBLEMS	POSSIBLE CAUSES	SOLUTIONS
Food does not bake or roast properly	<ul style="list-style-type: none"> • Improper oven controls setting. • Incorrect rack position. • Incorrect cookware or cookware of improper size being used. • Oven thermostat needs adjustment. • Clock not set correctly. • Aluminum foil used improperly in the oven. 	<ul style="list-style-type: none"> • See the “USING THE OVEN” section in user’s guide. • See the “USING THE OVEN” section in user’s guide. • See the “USING THE OVEN” section in user’s guide. • See the “HOW TO ADJUST THE OVEN THERMOSTAT” section in user’s guide. • See the “USING THE CLOCK AND TIMER” section in user’s guide. • See the “CARE AND CLEANING OF THE RANGE” section in user’s guide.
Food does not broil properly in the oven	<ul style="list-style-type: none"> • Improper oven controls setting. • Oven door not closed. • Incorrect rack position. • Food being cooked in a hot pan. • Cookware not suited for broiling. • Aluminum foil used on the broiling pan and grid has not been fitted properly and slit as recommended. 	<ul style="list-style-type: none"> • Make sure you touch the “BROIL HI/LO” pad. • See the “USING THE OVEN” section in user’s guide. • See the “BROILING GUIDE” in user’s guide. • Use the broiling pan and grid that came with your range. Make sure it is cool. • Use the broiling pan and grid that came with your range. • See the “USING THE OVEN” section in user’s guide.
Moisture collects on oven window or steam comes from oven vent	<ul style="list-style-type: none"> • When cooking foods high in moisture. • Excessive moisture was used when cleaning the window. 	<ul style="list-style-type: none"> • This is normal
Oven temperature too hot or too cold	<ul style="list-style-type: none"> • Oven thermostat needs adjustment. 	<ul style="list-style-type: none"> • See the “HOW TO ADJUST THE OVEN THERMOSTAT” section in user’s guide.
Clock and timer does not work	<ul style="list-style-type: none"> • The plug on range is not completely inserted in the electrical outlet. • A fuse in your home may be blown or the circuit breaker tripped. • Improper oven controls setting. 	<ul style="list-style-type: none"> • Make sure the electrical plug is inserted into a live, properly grounded outlet. • Replace the fuse or reset the circuit breaker. • See the “USING THE CLOCK AND TIMER” section in user’s guide.
Oven light does not work	<ul style="list-style-type: none"> • The light bulb is loose or defective. • The plug on range is not completely inserted in the electrical outlet. 	<ul style="list-style-type: none"> • Tighten or replace the bulb. • Make sure the electrical plug is inserted into a live, properly grounded outlet.

TROUBLE SHOOTING

PROBLEMS	POSSIBLE CAUSES	SOLUTIONS														
Oven will not selfclean	<ul style="list-style-type: none"> The oven temperature is too high to set a self-clean operation. Improper oven controls setting. 	<ul style="list-style-type: none"> Allow the range to cool to room temperature and reset the controls. See the "USING THE SELF-CLEANING OVEN" section in user's guide. 														
"Crackling" or "popping" sound	<ul style="list-style-type: none"> This is the sound of the metal heating and cooling during both the cooking and cleaning functions. 	<ul style="list-style-type: none"> This is normal. 														
Too much smoking during a self clean cycle.	<ul style="list-style-type: none"> Too much soil. 	<ul style="list-style-type: none"> Touch the "CLEAR OFF" pad. Open the windows to get rid of smoke from the room. Wait until the DOOR LOCKED light goes off. Wipe up the excess soil and reset the clean cycle. 														
Oven door will not open after a self-clean cycle	<ul style="list-style-type: none"> The oven temperature is too high. 	<ul style="list-style-type: none"> Allow the oven to cool below locking temperature. This can take up to 1 hr after the cycle is complete. 														
Oven not clean after a self-clean cycle	<ul style="list-style-type: none"> Improper oven controls setting. The oven was heavily soiled. 	<ul style="list-style-type: none"> See the Using the "USING THE SELF-CLEANING OVEN" section in user's guide. Clean up heavy spillovers before beginning the self- clean cycle. Heavily soiled ovens may need to self-clean again or for a longer period of time. 														
"CLOSE DOOR TO CONTINUE BROILING" or "DOOR OPENED" appears in the display	<ul style="list-style-type: none"> The broil or self-clean cycle has been selected but the door is not closed. 	<ul style="list-style-type: none"> Close the oven door. 														
"DOOR LOCKED" light is on when you want to cook	<ul style="list-style-type: none"> The oven door is locked because the temperature inside the oven has not dropped below the locking temperature. 	<ul style="list-style-type: none"> Touch the "CLEAR OFF" pad. Allow the oven to cool. 														
Oven control beeps and displays any F code error.	<table border="1" style="width: 100%; border-collapse: collapse;"> <thead> <tr> <th style="text-align: center;">CODE</th> <th style="text-align: center;">CAUSE</th> </tr> </thead> <tbody> <tr> <td style="text-align: center;">F-1</td> <td>Open oven sensor</td> </tr> <tr> <td style="text-align: center;">F-2</td> <td>Shorted oven sensor</td> </tr> <tr> <td style="text-align: center;">F-3</td> <td>Shorted keypad</td> </tr> <tr> <td style="text-align: center;">F-6</td> <td>Oven is too hot</td> </tr> <tr> <td style="text-align: center;">F-10</td> <td>Door locking system don't operate</td> </tr> <tr> <td style="text-align: center;">F-11</td> <td>No heating</td> </tr> </tbody> </table>	CODE	CAUSE	F-1	Open oven sensor	F-2	Shorted oven sensor	F-3	Shorted keypad	F-6	Oven is too hot	F-10	Door locking system don't operate	F-11	No heating	<ul style="list-style-type: none"> See the page 9-1 in this manual
CODE	CAUSE															
F-1	Open oven sensor															
F-2	Shorted oven sensor															
F-3	Shorted keypad															
F-6	Oven is too hot															
F-10	Door locking system don't operate															
F-11	No heating															

TROUBLE SHOOTING

PROBLEMS	POSSIBLE CAUSES	SOLUTIONS
Oven racks are difficult to slide	<ul style="list-style-type: none"> The oven racks were cleaned in a self-clean cycle. 	<ul style="list-style-type: none"> Apply a small amount of vegetable oil to a paper towel and wipe the edges of the oven racks with the paper towel. Do not use lubricant sprays.
Power outage, clock flashes	<ul style="list-style-type: none"> Power outage or surge. 	<ul style="list-style-type: none"> Reset the clock. If the oven was in use, you must reset it by touching the "CLEAR OFF" pad, setting the clock and resetting any cooking function.
"Burning" or "oily" odor emitting from the vent	<ul style="list-style-type: none"> This is normal in a new oven and will disappear in time. 	<ul style="list-style-type: none"> To speed the process, set a self-clean cycle for a minimum of 3 hours. See the "USING THE SELF-CLEANING OVEN" section.
Strong odor	<ul style="list-style-type: none"> An odor from the insulation around the inside of the oven is normal for the first few times the oven is used. 	<ul style="list-style-type: none"> This is temporary.
Fan noise	<ul style="list-style-type: none"> The convection fan may turn on and off automatically. 	<ul style="list-style-type: none"> This is normal. The convection fan will shut off if the door is opened.
Convection fan not working (convection models)	<ul style="list-style-type: none"> Preheat temperature not reached. Operates opposite the heating cycle. 	<ul style="list-style-type: none"> Fan will start automatically once the preheat temperature is reached. This is normal.
Drawer does not slide smoothly or drags	<ul style="list-style-type: none"> The drawer is out of alignment. Drawer is over-loaded or load is unbalanced. 	<ul style="list-style-type: none"> Fully extend the drawer and push it all the way in. See "CARE AND CLEANING OF THE RANGE" section in user's guide. Reduce weight. Redistribute drawer contents.
Warming drawer will not work (only for LRG3097S)	<ul style="list-style-type: none"> A fuse in your home may be blown or the circuit breaker tripped. The oven is self-cleaning. Controls improperly set. 	<ul style="list-style-type: none"> Replace the fuse or reset the circuit breaker. Wait for the self-clean cycle to finish and the oven to cool. See the "USING THE ELECTRIC WARMING DRAWER" section in user's guide.
Excessive condensation in the drawer	<ul style="list-style-type: none"> Liquid in drawer. Uncovered foods. Temperature setting too high. 	<ul style="list-style-type: none"> Remove liquid. Cover food with lid or aluminum foil. Reduce temperature setting.
Food dries out in warming drawer	<ul style="list-style-type: none"> Moisture escaping. Drawer not fully closed. 	<ul style="list-style-type: none"> Cover food with lid or aluminum foil. Push drawer in until latch engages.

INTRODUCTION (II)

For Model: LRG3093SB
LRG3093SW

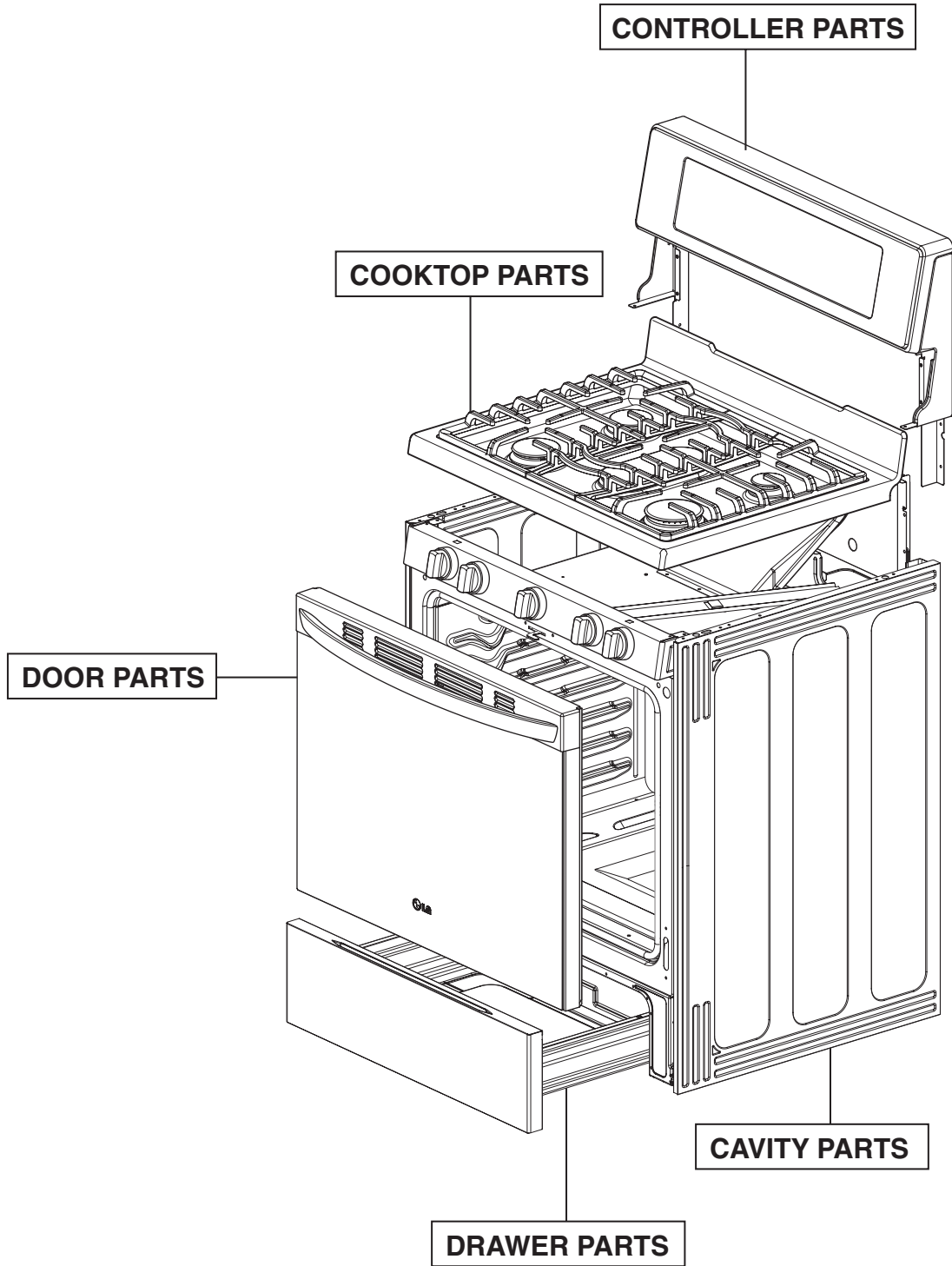

CONTROLLER PARTS

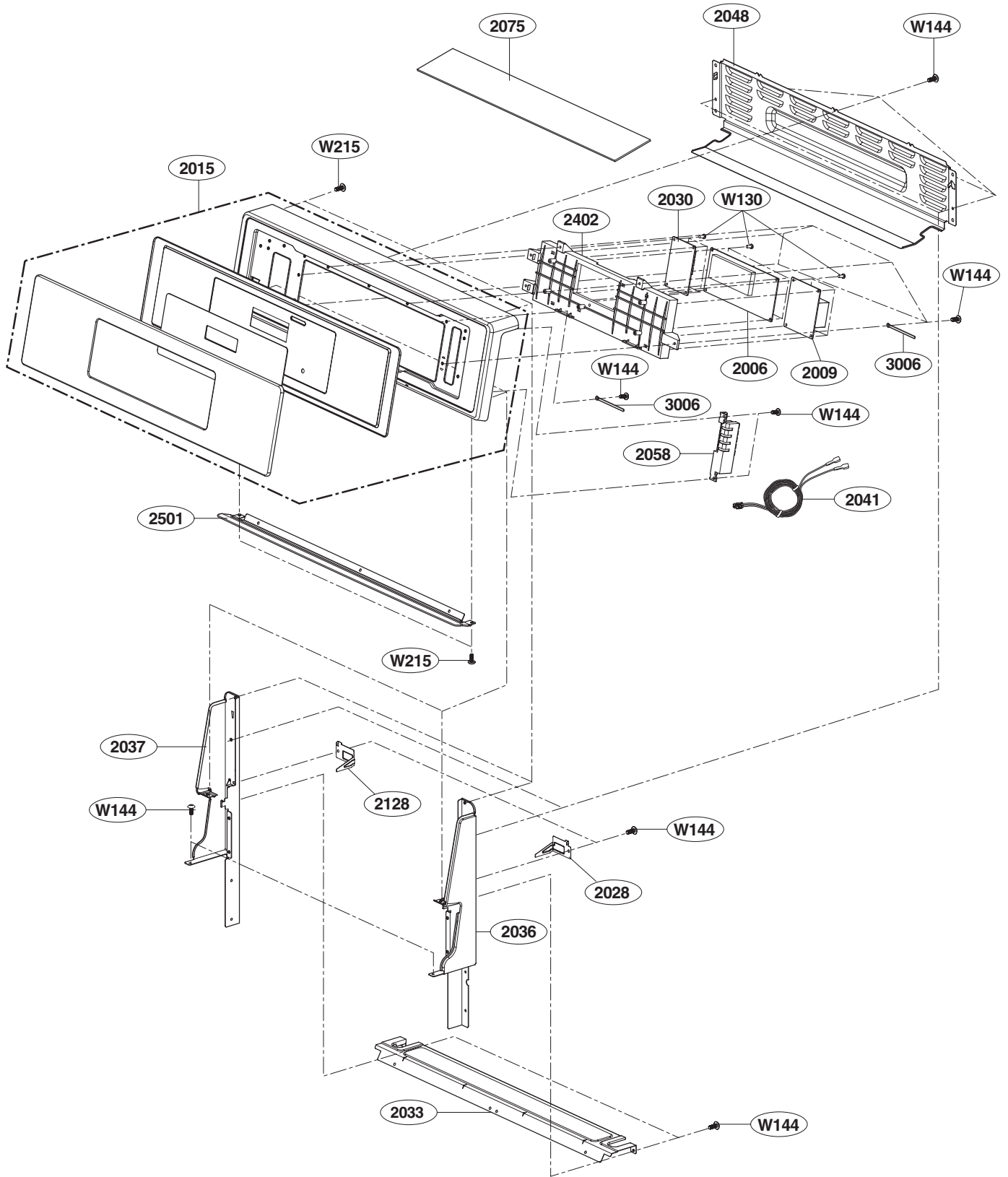

COOKTOP PARTS

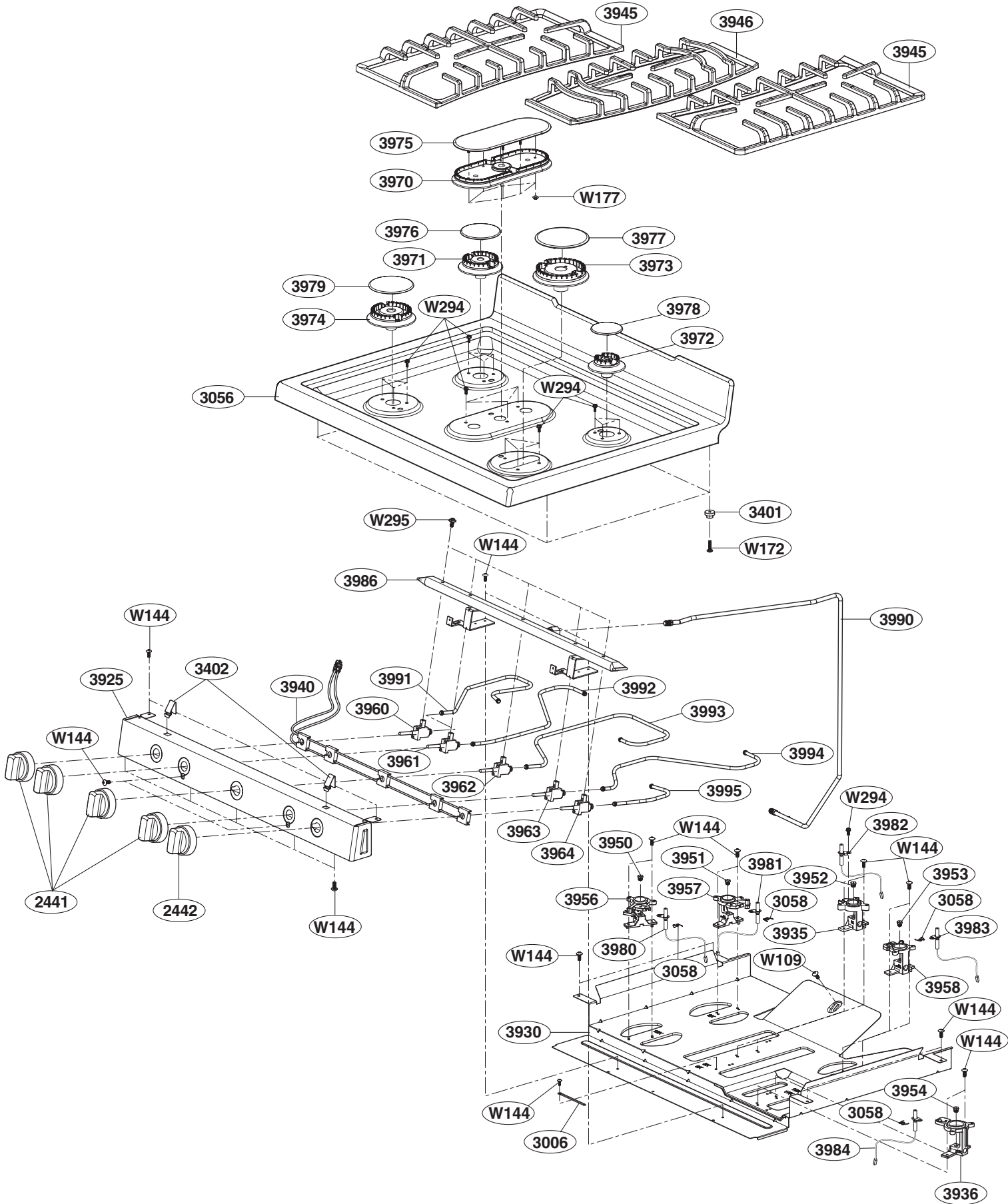

DRAWER PARTS

