

This Owner's Manual is provided and hosted by [Appliance Factory Parts](#).



LG LRG3095SW Owner's Manual

[Shop genuine replacement parts for LG LRG3095SW](#)



[Find Your LG Gas Range Parts - Select From 55 Models](#)

----- Manual continues below -----



To contact LG Electronics, 24 hours a day,
7 days a week:

1-800-243-0000 (USA)

Or visit us on the Web at: us.lge.com (USA)

GAS RANGE

USER'S GUIDE

Please read this guide
thoroughly before
operating and keep it handy
for reference at all times.

Models

LRG3097ST
LRG3095ST
LRG3095SB
LRG3095SW



Printed in Mexico
P/No. MFL33029602

INTRODUCTION

IMPORTANT SAFETY INFORMATION

Important Safety Instructions.....	3
What to Do if You Smell Gas.....	4
Basic Safety Precautions.....	4-8

OPERATING INSTRUCTIONS

Parts and Features.....	9
Using the Surface Burners.....	10-11
Using the griddle.....	12
Control Panel—LRG3097S.....	13
Control Panel—LRG3095S.....	14
Using the Oven.....	15-18
Using the Clock and Timer.....	19-20
Using the Timed Baking and Roasting Features.....	20-21
Using the Convection Oven.....	22-25
Using the Timed Convection Baking or Roasting Features.....	26-27
Using the Favorite Feature.....	28
Setting the Warm Feature.....	28
Setting the Proof Feature.....	29
Special Features of Your Oven Control.....	30-32
Using the Electric Warming Drawer (on some models).....	33-34
Using the Self-Cleaning Oven.....	35-36

CARE AND CLEANING OF THE RANGE

Care and Cleaning.....	37
Burner Caps and Heads.....	38
Burner Grates.....	39
Cooktop Surface.....	39
Stainless Steel Surfaces.....	40
Oven Air Vents.....	40
Control Panel.....	40
Front Manifold Panel and Knobs.....	40
Oven Door.....	41
Oven Bottom.....	42
Broiler Pan and Grid.....	42
Oven Racks and Drawer Racks.....	43
Oven Light Replacement.....	43
Removable Warming Drawer.....	44

TROUBLESHOOTING

Before Calling for Service.....	45-48
---------------------------------	-------

WARRANTY

Product Registration Information.....	49
---------------------------------------	----

THANK YOU!

Congratulations on your purchase and welcome to the LG family. Your new LG Gas Range combines precision cooking features with simple operation and stylish design. By following the operating and care instructions in this manual, your range will provide you with many years of reliable service.

Product Registration Information

Model: _____

Serial Number: _____

Date of Purchase: _____

IMPORTANT SAFETY INFORMATION

READ ALL INSTRUCTIONS BEFORE USE

IMPORTANT SAFETY INSTRUCTIONS

Read and follow all instructions before using your oven to prevent the risk of fire, electric shock, personal injury, or damage when using the range. This guide do not cover all possible conditions that may occur. Always contact your service agent or manufacturer about problems that you do not understand.



This is the safety alert symbol. This symbol alerts you to potential hazards that can kill or hurt you and others. All safety messages will follow the safety alert symbol and either the word "WARNING" or "CAUTION".



WARNING

This symbol will alert you to hazards or unsafe practices which could cause serious bodily harm or death.



CAUTION

This symbol will alert you to hazards or unsafe practices which could cause bodily injury or property damage.

WARNING: If the information in this manual is not followed exactly, a fire or explosion may result causing property damage, personal injury or death.

- DO NOT store or use gasoline or other flammable vapors and liquids in the vicinity of this or any other appliance.

WHAT TO DO IF YOU SMELL GAS

- Open windows.
- DO NOT try to light any appliance.
- DO NOT touch any electrical switch.
- DO NOT use any phone in your building.
- Immediately call your gas supplier from a neighbor's phone. Follow the gas supplier's instructions.
- If you cannot reach your gas supplier, call the fire department.

Installation and service must be performed by a qualified installer, service agency or the gas supplier.

ANTI-TIP DEVICE



WARNING



- ALL RANGES CAN TIP
- INJURY TO PERSONS COULD RESULT



- INSTALL ANTI-TIP DEVICES PACKED WITH RANGE
- SEE INSTALLATION



IMPORTANT SAFETY INFORMATION

READ ALL INSTRUCTIONS BEFORE USE

ANTI-TIP DEVICE (continued)

- **DO NOT step or sit on the door. Install the Anti-Tip Bracket packed with range.**
- The range could be tipped and injury might result from spilled hot liquid, food, or the range itself.
- If the range is pulled away from the wall for cleaning, service, or any other reason, ensure that the Anti-Tip Device is properly reengaged when the range is pushed back against the wall.

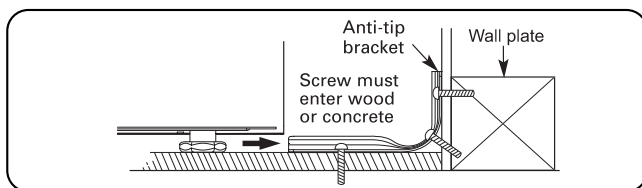

- To reduce the risk of tipping of the range, the range must be secured by properly installing anti-tip devices.
- To check that the anti-tip bracket is properly installed: Grasp the top rear edge of the range back guard and carefully attempt to tilt it forward. Verify that the anti-tip devices are engaged.
- Warming drawer or Storage drawer : Remove drawer and visually inspect that the rear leveling leg is fully inserted into the anti-tip bracket.
- Refer to the installation manual for proper anti-tip bracket installation.

IMPORTANT SAFETY NOTICE

Enforcement Act requires the Governor of California to publish a list of substances known to the state to cause birth defects or other reproductive harm, and requires businesses to warn customers of potential exposure to such substances.

Gas appliances can cause minor exposure to four of these substances, namely benzene, carbon monoxide, formaldehyde and soot, caused primarily by the imperfect combustion of natural or LP gas. Correctly adjusted burners, indicated by a bluish rather than a yellow flame, will minimize imperfect combustion. Exposure to these substances can be minimized by opening windows or using a ventilation fan or hood.

SAFETY PRECAUTIONS

Have the installer show you the location of the range gas shut-off valve and how to shut it off if necessary.

- Make sure your range is properly installed and grounded by a qualified installer, according to the installation instructions. Any adjustment and service should be performed only by qualified gas range installers or service technicians.
- Plug your range into a 120-volt grounded outlet only. Do not remove the round grounding prong from the plug. If in doubt about the grounding of the home electrical system, it is your personal responsibility and obligation to have an ungrounded outlet replaced with a properly grounded, three-prong outlet in accordance with the National Electrical Code. Do not use an extension cord with this range.
- **DO NOT** use an adapter plug, an extension cord, or remove grounding prong from electrical power cord to prevent fire hazard or electrical shock. Failure to follow this warning can cause serious injury, fire or death.
- To prevent poor air circulation, place the range out of kitchen traffic path and out of drafty locations.
- **DO NOT** attempt to repair or replace any part of your range unless it is specifically mentioned in this manual. All other service should be referred to a qualified technician.
- Make sure all packaging materials are removed from the range before operating it to prevent fire or smoke damage should the packaging material ignite.

IMPORTANT SAFETY INFORMATION

READ ALL INSTRUCTIONS BEFORE USE

SAFETY PRECAUTIONS (continued)

- Make sure your range is properly adjusted by a qualified service technician or installer for the type of gas (natural or LP) that is to be used. Your range can be converted for use with either type of gas. See the installation instructions.

⚠ WARNING: These adjustments must be done by a qualified service technician according to the manufacturer's instructions and all codes and requirements of the authority having jurisdiction. Failure to follow these instructions could result in serious injury or property damage. The qualified agency performing this work assumes responsibility for the conversion.

- After using your range for a long time, high floor temperatures may result and many floor coverings will not withstand this kind of use. Never install the range over vinyl tile or linoleum that cannot withstand such type of use. Never install it directly over interior kitchen carpeting.

⚠ CAUTION: Items of interest to children should not be placed in cabinets above a range or on the backsplash of a range—children climbing on the range to reach items could be seriously injured.

- **DO NOT** leave children alone or unattended where a range is hot or in operation. They could be seriously burned.
- **DO NOT** let anyone climb, stand or hang on the oven door, warming drawer or cooktop. They could damage the range and even tip it over, causing severe personal injury.

⚠ WARNING: **NEVER** use your range as a space heater to heat or warm the room. Doing so may result in carbon monoxide poisoning and overheating of the oven.

- **NEVER** wear loose fitting or hanging garments while using the appliance. Be careful when reaching for items placed in cabinets over the range. Flammable material could be ignited if brought in contact with flame or hot oven surfaces and may cause severe burns.

- **DO NOT** place flammable materials in an oven, a warming drawer or near a cooktop.
- **DO NOT** place or use combustible materials such as gasoline or other flammable vapors and liquids in the vicinity of this or any other appliance.
- **DO NOT** allow cooking grease or other flammable materials in or near the range.
- **DO NOT** use water on grease fires. Never touch a flaming pan. Turn the controls off. Smother a flaming pan on a surface burner by covering the pan completely with a well-fitting lid, cookie sheet or flat tray. Use a multi-purpose dry chemical or foam-type fire extinguisher.
A grease fire can be put out by covering it with baking soda or, if available, by using a multi-purpose dry chemical or foam-type fire extinguisher. Flame in the upper oven or lower oven drawer can be smothered completely by closing the oven door or drawer and turning the control to off or by using a multi-purpose dry chemical or foam-type fire extinguisher.
- **DO NOT** use the oven or the drawer for storage.
- Let the burner grates and other surfaces cool before touching them.
- **NEVER** block the vents (air holes) of the range. They provide the air inlet and outlet that are necessary for the range to operate properly with correct combustion. Air openings are located at the rear of the cooktop, at the top and bottom of the oven door, and at the bottom of the range under the warming drawer.
- Large scratches or impacts to glass doors can lead to broken or shattered glass.
- Stepping, leaning or sitting on the doors or drawers of this range can result in serious injuries and also cause damage to the range. Do not allow children to climb or play around the range. The weight of a child on an open door may cause the range to tip, resulting in serious burns or other injury.
- Leak testing of the appliance shall be conducted according to the manufacturer's instructions.

IMPORTANT SAFETY INFORMATION

READ ALL INSTRUCTIONS BEFORE USE

SURFACE BURNERS

WARNING:

- If the top burner flame goes out, gas is still flowing to the burner until the knob is turned to the “OFF” position. Do not leave the burners “ON” unattended.
- **Use proper pan size - DO NOT** use pans that are unstable or easily tipped. Select cookware having flat bottoms large enough to cover burner grates. To avoid spillovers, make sure cookware is large enough to contain the food properly. This will both save cleaning time and prevent hazardous accumulations of food, since heavy spattering or spillovers left on range can ignite. Use pans with handles that can be easily grasped and remain cool.

- **NEVER** leave the surface burners unattended at high flame settings. Boilovers cause smoking and greasy spillovers that may catch on fire.
- Always turn knob to the “LITE” position when igniting the top burners and make sure the burners have ignited.
- Control the top burner flame size so it does not extend beyond the edge of the cookware. Excessive flame is hazardous.
- Use only dry pot holders—moist or damp pot holders on hot surfaces may result in burns from steam. Do not let pot holders come near open flames when lifting cookware. Do not use a towel or other bulky cloth. Instead of a pot holder.
- Using glass cookware—make sure it is designed for top-of-range cooking.
- To prevent burns, ignition of flammable materials and spillage, turn cookware handles toward the side or back of the range without extending over adjacent burners.
- **NEVER** place any items on the cooktop. The hot air from the vent may ignite flammable items and will increase pressure in closed containers, which may cause them to burst.
- Carefully watch foods being fried at a high flame setting.
- Always heat fat slowly, and watch as it heats.
- If frying combinations of oils and fats stir together before heating.
- Use a deep fat thermometer if possible to prevent overheating fat beyond the smoking point.
- Use the least possible amount of fat for effective shallow or deep-fat frying. Filling the pan too full of fat can cause spillovers when food is added.
- **DO NOT** flame foods on the cooktop.
- **DO NOT** use a wok on the surface burners if the wok has a round metal ring that is placed over the burner grate to support the wok. This ring acts as a heat trap, which may damage the burner grate and burner head. Also, it may cause the burner to work improperly. This may cause a carbon monoxide level above that allowed by current standards, resulting in a health hazard.
- Foods for frying should be as dry as possible. Frost or moisture on foods can cause hot fat to bubble up and over the sides of the pan.
- **NEVER** try to move a pan of hot fat, especially a deep fat fryer. Wait until the fat is cool.
- **DO NOT** place plastic items on the cooktop—they may melt if left too close to the vent.
- Keep all plastics away from the surface burners.
- To prevent burns, always be sure that the controls for all burners are at the “OFF” position and all grates are cool before attempting to remove them.
- If you smell gas, turn off the gas to the range and call a qualified service technician. Never use an open flame to locate a leak.
- Always turn knob to the “OFF” position before removing cookware.
- **DO NOT** lift the cooktop. Lifting the cooktop can cause damage and improper operation of the range.
- If range is located near a window, do not hang long curtains that could blow over the surface burners and catch on fire.

IMPORTANT SAFETY INFORMATION

READ ALL INSTRUCTIONS BEFORE USE

COOK MEAT AND POULTRY THOROUGHLY

Cook meat and poultry thoroughly—meat to at least an INTERNAL temperature of 160°F and poultry to at least an INTERNAL temperature of 180°F.

To protect against foodborne illness, cook them to these temperatures.

ELECTRIC WARMING DRAWER (on some models)

- The purpose of the warming drawer is to hold hot cooked foods at serving temperature. Always start with hot food; cold food cannot be heated or cooked in the warming drawer.
- **DO NOT** touch the heating element or the interior surface of the drawer. These surfaces may be hot enough to burn.
REMEMBER: The inside surface of the drawer may be hot when the drawer is opened.
- Use care when opening the drawer. Open the drawer slightly and let hot air or steam escape before removing or replacing food. Hot air or steam which escapes can lead to burns to hands, face and/or eyes.
- **DO NOT** dry newspapers in the drawer. If overheated, they can catch on fire.
- **DO NOT** place paper products, plastics, canned food, or combustible materials in the drawer.
- **NEVER** place jars or cans of fat drippings in or near your drawer.
- **DO NOT** warm food in the drawer for more than 2 hours.
- **DO NOT** use aluminum foil to line the warming drawer. Foil is an excellent heat insulator and will trap heat beneath it. This will upset the performance of the drawer and it could damage the interior surface.

SELF-CLEANING OVEN

- Make sure to wipe off excess spillage before self-cleaning operation.
- **DO NOT** use oven cleaners. No commercial oven cleaner or oven liner protective coating of any kind should be used in or around any part of the oven. Residue from oven cleaners will damage the inside of the oven when the self-clean cycle is used.
- Oven racks and accessories should be removed from the oven before self clean is started. Also remove any items placed in the bottom drawer before starting a self clean cycle.
- Clean only parts listed in this manual.
- **DO NOT** clean the door gasket. The door gasket is necessary for a good seal. Care should be taken not to rub, damage or move the gasket.
- If the self-cleaning mode malfunctions, turn the range off and disconnect the power supply. Let it serviced by a qualified technician.

IMPORTANT SAFETY INFORMATION

READ ALL INSTRUCTIONS BEFORE USE

OVEN

When opening the door of a hot oven, stand away from the range. The hot air and steam that escape can cause burns to hands, face and eyes.

⚠ WARNING: NEVER block any slots, holes or passages in the oven bottom or cover an entire rack with materials such as aluminum foil. Doing so blocks air flow through the oven and may cause carbon monoxide poisoning. Aluminum foil linings may also trap heat, causing a fire hazard.

- **DO NOT** heat closed food containers. Pressure could increase and the container could burst, causing an injury.
- **DO NOT** use aluminum foil anywhere in the oven except as described in this manual. Doing so could create a fire hazard or cause damage to the range.
- **DO NOT** use the oven for a storage area. Items stored in the oven can catch on fire.
- Keep the oven free from grease buildup.
- Insert the oven racks in the desired position while the oven is cool.
- To prevent burns when removing food, slide racks out until the stop engages, then remove food items. It is also a precaution against burns from touching hot surfaces of the door or oven walls.
- When placing or removing griddle always wear oven mitts.

- When using cooking or roasting bags in the oven, follow the manufacturer's directions.
- Use only glass cookware that is recommended for use in gas ovens.
- Always remove the broiler pan from the range after you finish broiling. Grease left in the pan can catch fire if oven is used without removing the grease from the broiler pan.
- When broiling, if meat is too close to the flame, the fat may ignite. To prevent excessive flare-ups, trim excess fat.
- Make sure the broiler pan is in place correctly to minimize the possibility of grease fires.
- If you should have a grease fire in the broiler pan, press the "**CLEAR OFF**" pad, and keep the oven door closed to contain fire until it burns out.
- For safety and better cooking performance, always bake and broil with the oven door closed.

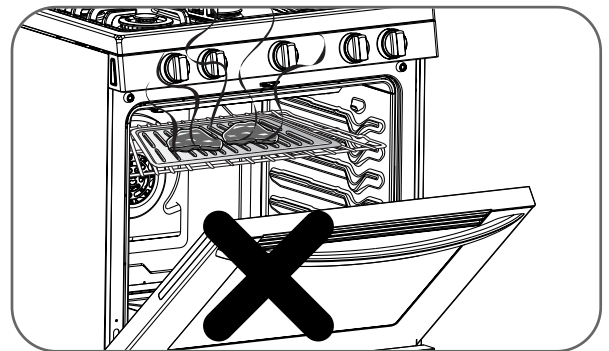

NOTE: Open door baking or broiling can cause damage to the knobs or valves.
DO NOT LEAVE THE OVEN DOOR OPEN DURING COOKING OR COOL DOWN.

**READ AND FOLLOW THIS SAFETY INFORMATION CAREFULLY.
SAVE THESE INSTRUCTIONS**

OPERATING INSTRUCTIONS

PARTS AND FEATURES

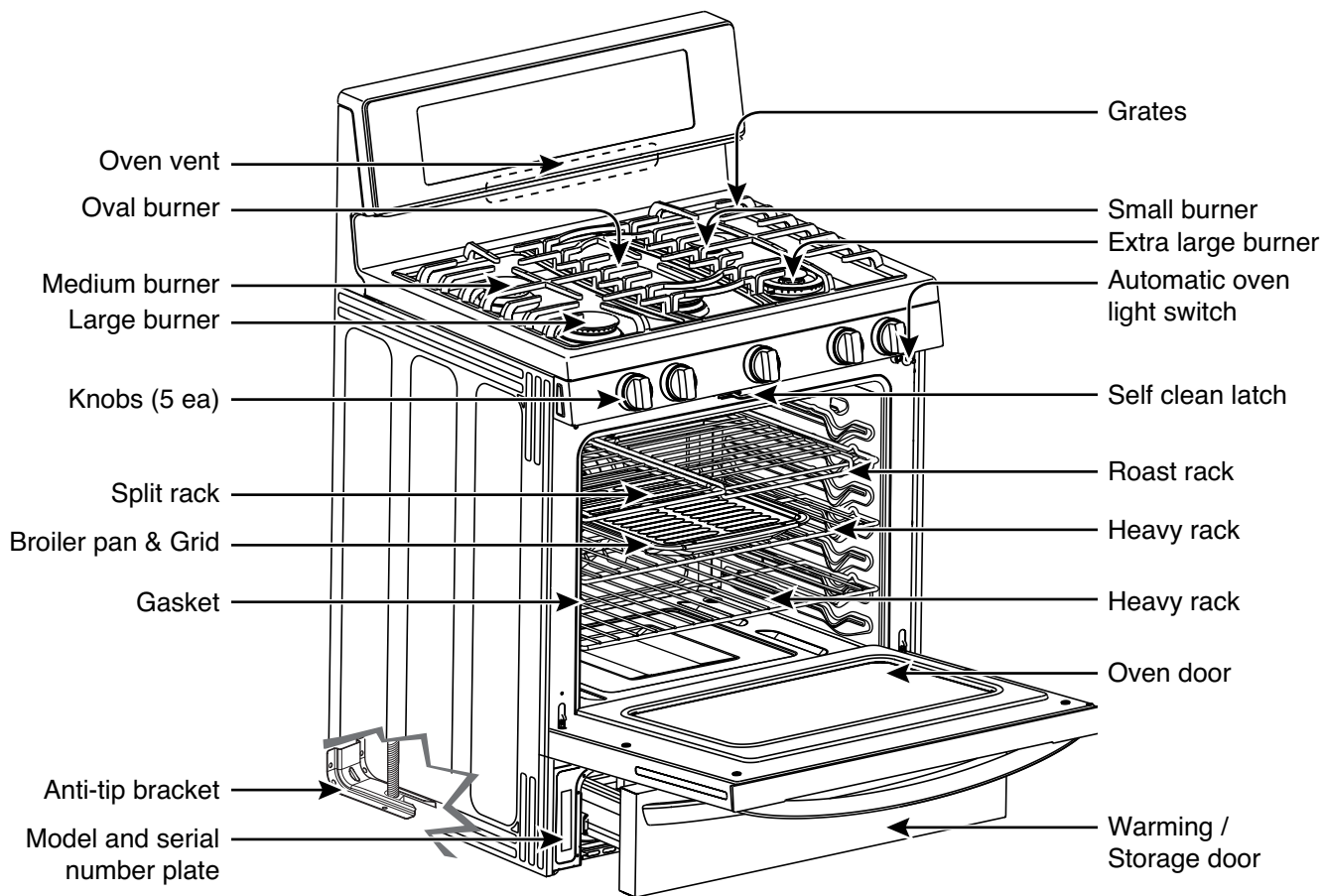

Dual Purpose

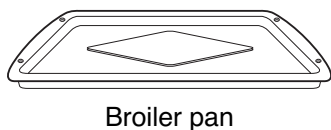
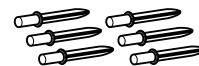
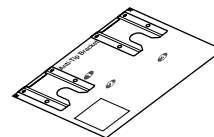
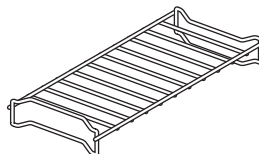
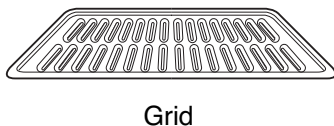
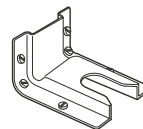
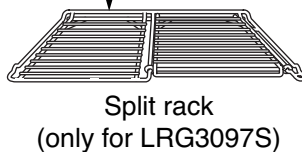
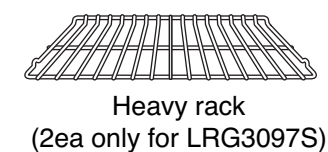

OPERATING INSTRUCTIONS

USING THE GAS SURFACE BURNERS

Throughout this manual, features and appearance may vary from your model.

- Make sure all grates on the range are properly placed before using any burner.
- Be sure the burners and grates are cooled down before you place your hand, a pot holder, cleaning cloths or other materials on them.
- Make sure all burners are in place.
- **DO NOT** operate the burner for an extended period of time without cookware on the grate. The finish on the grate may chip without cookware to absorb the heat.

HOW TO LIGHT A GAS SURFACE BURNER

- Be sure all the surface burners are placed in their respective positions.
- Push the control knob in and turn it to the “LITE” position.
- You will hear a little **clicking** noise— the sound of the electric spark igniting the burner.
- To control the flame size, turn the knob. If the knob stays at “LITE”, it will continue to click.
- When turning a burner to “LITE”, all the burners spark. Do not attempt to disassemble or clean around any burner while another burner is on. An electric shock may result, which could cause you to knock over hot cookware.

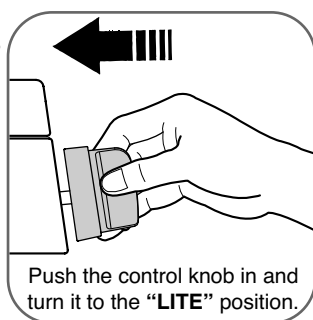

IN CASE OF POWER FAILURE

In case of a power failure, you can light the gas surface burners on your range with a match. Hold a lit match to the burner, then push in and turn the control knob to the “LITE” position. Use extreme caution when lighting burners this way.

Surface burners in use when an electrical power failure occurs will continue to operate normally.

SEALED GAS BURNERS

Your gas range cooktop has five sealed gas burners. They offer convenience, cleanability and flexibility to be used in a wide range of cooking applications. The smallest burners are in the right rear position. This burner can be turned down to a low simmer setting.

It provides precise cooking performance for delicate foods such as sauces or foods that require low heat for a long cooking time.

The medium (left rear) and the large (left front) burners are the primary burners for most cooking. These general-purpose burners can be turned down from “HI” to “LO” to suit a wide range of cooking needs.

The extra large burner (right front) is the maximum output burner. Like the other four burners, it can be turned down from “HI” to “LO” for a wide range of cooking applications.

This burner is also designed to quickly bring large amounts of liquid to a boil. It can be used with cookware 10 inches or larger in diameter.

The oval burner (center) is for use with a griddle or oval pots.

NOTE: The right front burner, by design, is raised up from the cooktop. This is normal.

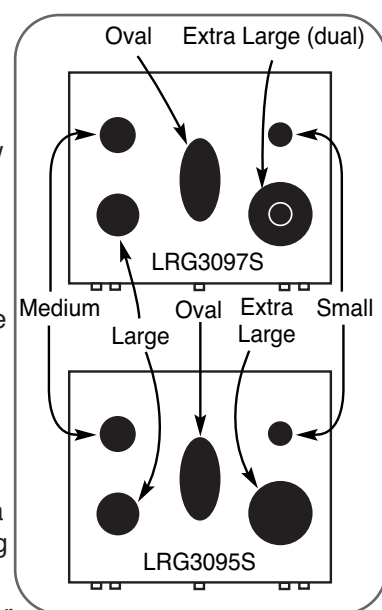

OPERATING INSTRUCTIONS

USING THE GAS SURFACE BURNERS

HOW TO SELECT FLAME SIZE

NEVER let the flames extend up the sides of the cookware for safe handling of cookware.

Watch the flame, not the knob, as you reduce heat. When fast heating is desired, the flame size on a gas burner should match the cookware you are using.

Flames larger than the bottom of the cookware will not result in faster heating of the cookware and could be hazardous.

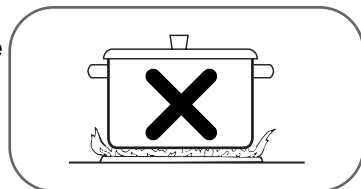

TOP-OF-RANGE COOKWARE

Aluminum: Medium-weight cookware is recommended because it heats quickly and evenly. Most of the foods brown evenly in an aluminum skillet. Use saucepans with tightfitting lids when cooking with minimum amounts of water.

Cast-Iron: If heated slowly, most skillets will give satisfactory results.

Stainless Steel: This metal alone has poor heating properties and is usually combined with copper, aluminum or other metals for improved heat distribution. Combination metal skillets usually work satisfactorily if they are used with medium heat as the manufacturer recommends.

Enamelware: Under some conditions, the enamel of some cookware may melt. Follow cookware manufacturer's recommendations for cooking methods.

Glass: There are two types of glass cookware—those for oven use only and those for top-of-range cooking (saucepans, coffee and teapots). Glass conducts heat very slowly.

Heatproof Glass Ceramic: Can be used for either surface or oven cooking. It conducts heat very slowly and cools very slowly. Check cookware manufacturer's directions to be sure it can be used on gas ranges.

USING A WOK

DO NOT use a wok support ring. Placing the ring over the burner or grate may cause the burner to work improperly, resulting in carbon monoxide levels above allowable standards.

This can be hazardous to your health.

Only a flat-bottomed wok should be used.

We recommend that you use a 14-inch or smaller flat-bottomed wok. Make sure the wok bottom sits flat on the grate. They are available at your local retail store.

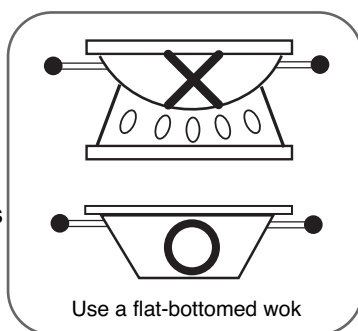

STOVE-TOP GRILLS

DO NOT use stove top grills on your surface burners. If you use the stove top grill on the surface burner, it will cause incomplete combustion and can result in exposure to carbon monoxide levels above allowable current standards.

This can be hazardous to your health.

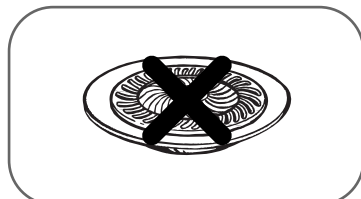

OPERATING INSTRUCTIONS

USING THE GRIDDLE

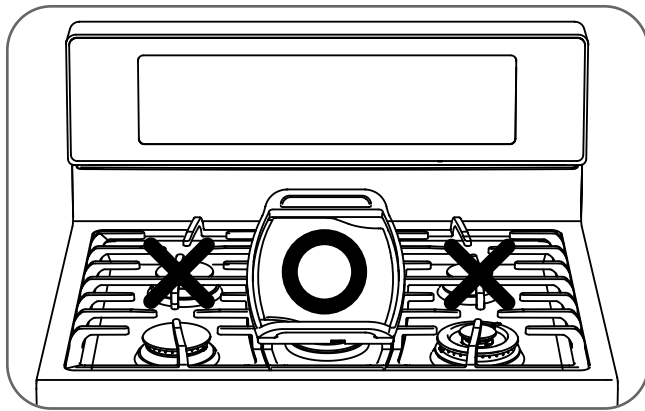

Your non-stick coated griddle provides an extra-large cooking surface for meats, pancakes or other food usually prepared in a frying pan or skillet.

NOTE: Your griddle will discolor over time as it becomes seasoned with use.

How to Place the Griddle: The griddle can only be used with the center burner. The griddle must be properly place on center grate as shown below illumination.

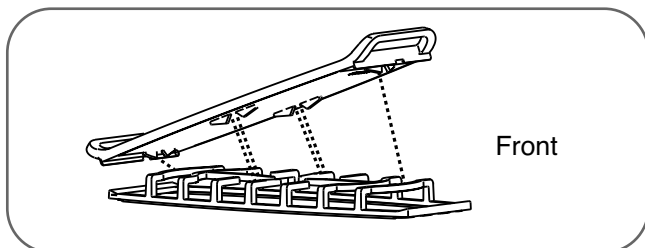

NOTE: DO NOT remove the center grate when using the griddle.

CAUTION: DO NOT remove the griddle plate until the cooktop grates, surfaces and griddle plate are completely cooled.

CAUTION: The griddle plate on the cooktop may become very hot when using the cooktop, oven or broiler systems. Always use oven mitts when placing or removing the griddle plate.

Preheat the griddle according to the guide below and adjust for the desired setting.

Type of Food	Preheat Conditions	Cook Setting
Warming Tortillas	none	3 (MED-LOW)
Pancakes	7 (MED-HI) 3 min.	7 (MED-HI)
Hamburgers	7 (MED-HI) 5 min.	7 (MED-HI)
Fried Eggs	HI 5 min.	4 (MED)
Bacon	none	5 (MED)
Breakfast Sausage Links	HI 5 min.	5 (MED)
Hot Sandwiches (such as Grilled Cheese)	HI 4 min.	HI

NOTE: Griddle settings may need to be adjusted if the griddle is used for an extended time.

IMPORTANT NOTES:

- Avoid cooking extremely greasy foods, grease spill over can occur.
- The griddle can become hot when surrounding burners are in use.
- **DO NOT** overheat the griddle. This can damage the non stick coating.
- **DO NOT** use metal utensils that can damage the griddle surface. Do not use the griddle as a cutting board.
- **DO NOT** place or store items on the griddle.

OPERATING INSTRUCTIONS

CONTROL PANEL—LRG3097S

Throughout this manual, features and appearance may vary from your model.

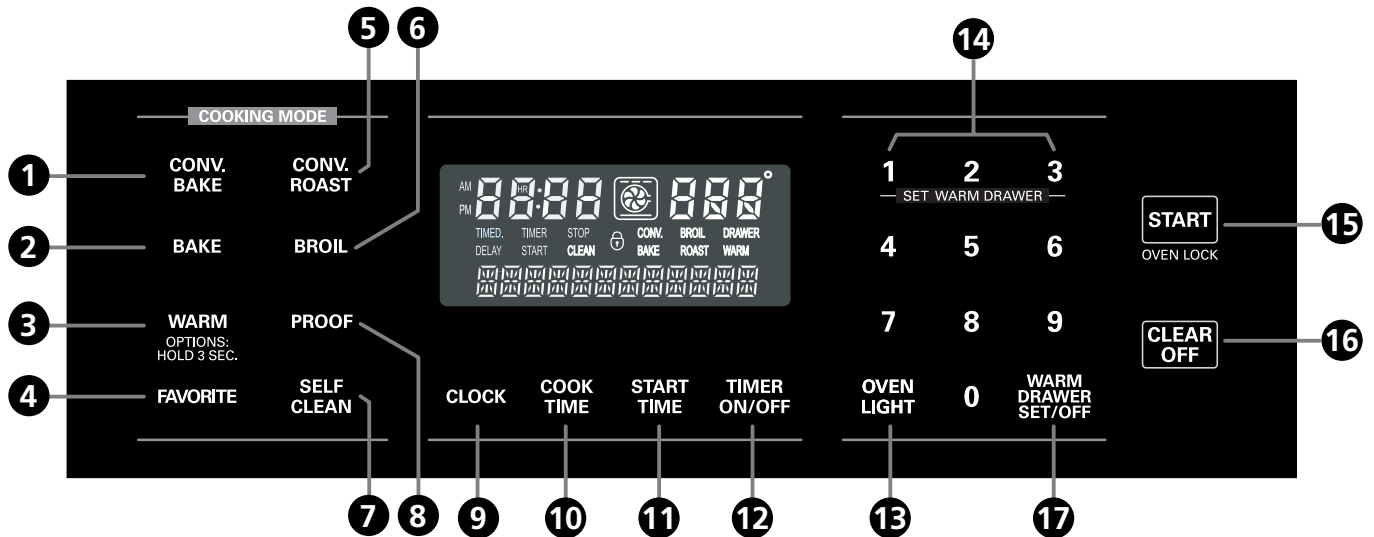

OVEN CONTROL, CLOCK, AND TIMER FEATURES

- 1 CONVECTION BAKE PAD** – Touch the pad to select baking with the Convection function.
- 2 BAKE PAD** – Touch the pad to enter the normal bake function.
- 3 WARM PAD / OPTIONS**
 - Touch this pad to hold food warm in the oven.
 - Touch and hold the pad for 3 seconds to change the special settings.**NOTE:** Special settings can only be used if no other function (Bake, Broil, Timer Ect.) of the control panel is in use.
- 4 FAVORITES PAD** – Touch the pad to select the favorite cooking feature.
- 5 CONVECTION ROAST PAD** – Touch the pad to select roasting with the Convection function.
- 6 BROIL PAD** – Touch the pad to select broil function.
- 7 SELF CLEAN PAD** – Touch the pad to select self-cleaning function.
- 8 PROOF PAD** – Touch the pad to proof bread.
- 9 CLOCK PAD** – Touch the pad to set the time of day.
- 10 COOK TIME PAD** – Touch this pad and then touch the number pads to set the amount of time you want your food to cook. The oven will shut off when the cooking time has run out.
- 11 START TIME PAD** – Touch this pad and then touch the number pad to set delayed start time. The oven will start at a time you set.
- 12 TIMER ON/OFF PAD** – Touch the pad to set or cancel the timer function.
- 13 OVEN LIGHT PAD** – Touch the pad to turn the oven light on or off.
- 14 NUMBER PADS** – Use to set any function requiring numbers such as clock, timer or temperature.
- 15 START PAD / OVEN LOCK**
 - Touch the pad to start all oven features.
 - Touch and hold the pad for 3 seconds to activate/deactivate the Oven Lockout function.
- 16 CLEAR OFF PAD** – Touch this pad to cancel ALL oven operations except the clock, timer and warming drawer settings.
- 17 WARM DRAWER PAD** – Touch this pad and then touch number pads 1-3 to use to use the warming drawer.

OPERATING INSTRUCTIONS

CONTROL PANEL—LRG3095S

Throughout this manual, features and appearance may vary from your model.

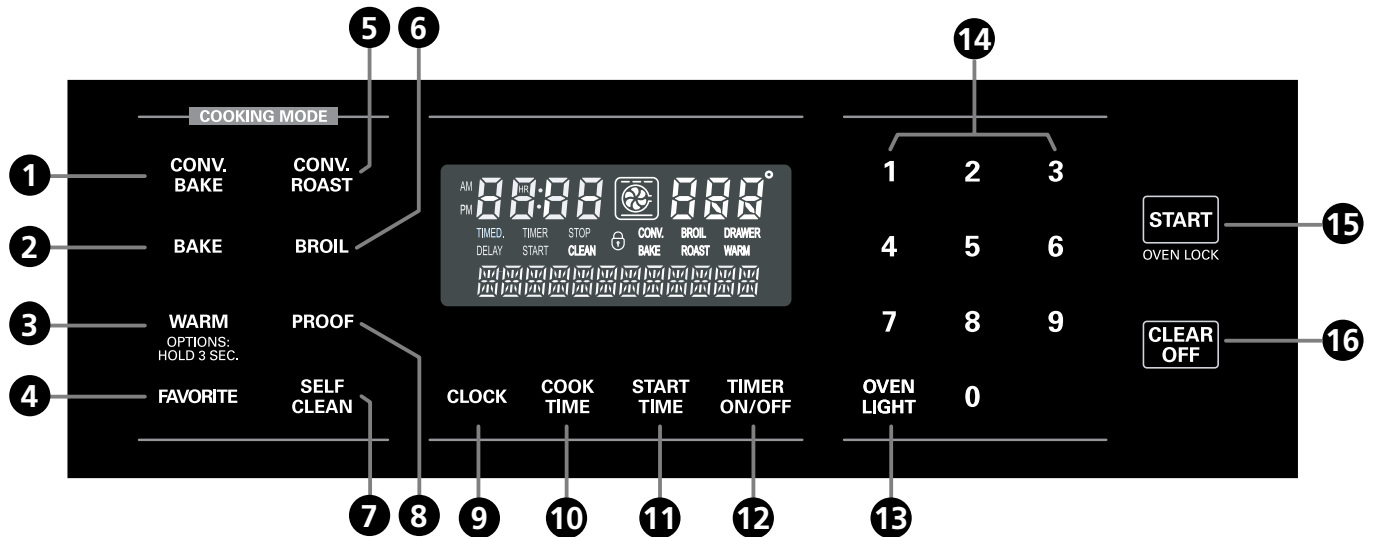

OVEN CONTROL, CLOCK, AND TIMER FEATURES

- 1 CONVECTION BAKE PAD** – Touch the pad to select baking with the Convection function.
- 2 BAKE PAD** – Touch the pad to enter the normal bake function.
- 3 WARM PAD / OPTIONS**
 - Touch this pad to hold food warm in the oven.
 - Touch and hold the pad for 3 seconds to change the special settings.**NOTE:** Special settings can only be used if no other function (Bake, Broil, Timer Ect.) of the control panel is in use.
- 4 FAVORITES PAD** – Touch the pad to select the favorite cooking feature.
- 5 CONVECTION ROAST PAD** – Touch the pad to select roasting with the Convection function.
- 6 BROIL PAD** – Touch the pad to select broil function.
- 7 SELF CLEAN PAD** – Touch the pad to select self-cleaning function.
- 8 PROOF PAD** – Touch the pad to proof bread.
- 9 CLOCK PAD** – Touch the pad to set the time of day.
- 10 COOK TIME PAD** – Touch this pad and then touch the number pads to set the amount of time you want your food to cook. The oven will shut off when the cooking time has run out.
- 11 START TIME PAD** – Touch this pad and then touch the number pad to set delayed start time. The oven will start at a time you set.
- 12 TIMER ON/OFF PAD** – Touch the pad to set or cancel the timer function.
- 13 OVEN LIGHT PAD** – Touch the pad to turn the oven light on or off.
- 14 NUMBER PADS** – Use to set any function requiring numbers such as clock, timer or temperature.
- 15 START PAD / OVEN LOCK**
 - Touch the pad to start all oven features.
 - Touch and hold the pad for 3 seconds to activate/deactivate the Oven Lockout function.
- 16 CLEAR OFF PAD** – Touch this pad to cancel ALL oven operations except the clock, timer and warming drawer settings.

OPERATING INSTRUCTIONS

USING THE OVEN

BEFORE YOU BEGIN

The oven has 7 rack positions for various types of cooking.

To install a rack insert the curved end of the rack into the desired position and push all the way back.

To remove a rack pull out until the rack stops, then tilt up and pull out.

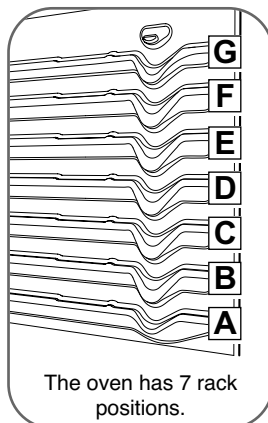

CAUTION: Always use potholders or oven mitts when removing food or adjusting the oven racks. Wait until the oven has completely cooled if possible. Oven racks may be HOT and may cause burns.

OVEN VENT

Your oven is vented through ducts at the center above the burner grate. Do not block the oven vent when cooking to allow for proper air flow. Do not touch vent openings or nearby surfaces during the use of any cooking operation.

- **DO NOT** place plastic or flammable items on the cooktop—they may melt or ignite if left too close to the vent.
- **DO NOT** place closed containers on the cooktop. The pressure in closed containers may increase, which may cause them to burst.
- Metal items will become very hot if they are left on the cooktop, and could cause burns.
- Handles of pots and pans on the cooktop may become hot if left too close to the vent.



POWER OUTAGE

CAUTION:

DO NOT attempt to operate the electric ignition oven during an electrical power failure.

The oven or broiler can not be used during a power outage.

If the oven is in use when a power failure occurs, the oven burner shuts off and cannot be re-lit until power is restored. Once power is restored you will need to restart the oven or broil function.

OVEN LIGHT

OVEN LIGHT The oven light automatically turns ON when the door is opened. The oven light may also be manually turned ON or OFF by touching the “OVEN LIGHT” pad.

NOTE :

- The oven light can not be turned on during a self clean cycle. The oven light can not be turned on until the oven temperature has cooled below 500° F (260° C) after a self clean cycle is complete.

OVEN MOISTURE

As your oven heats up, the temperature increase of the air in the oven may cause water droplets to form on the door glass. These droplets are harmless and will evaporate as the oven continues to heat up.

ALUMINUM FOIL

NEVER cover the oven bottom with aluminum foil.

Aluminum foil may also be used to catch a spillover. To do so, place a small sheet of foil on a lower rack several inches below the food.

NEVER entirely cover a rack with aluminum foil. This will disturb the heat circulation and result in poor baking.

OPERATING INSTRUCTIONS

USING THE OVEN

To avoid possible burns, place the racks in the desired position before you turn the oven on.

HOW TO SET THE OVEN FOR BAKING OR ROASTING

Your oven is not designed for open-door cooking.

BAKE ① Touch the “**BAKE**” pad.

1 2 3 ② Touch the **number** pads to set the desired temperature.

START ③ Touch the “**START**” pad.

The word “**BAKE**” and **100°** will be displayed. As the oven heats up, the display will show the changing temperature. When the oven reaches the temperature you set, the preheat alarm melody will sound and the oven light will flash.

To change the oven temperature during a **BAKE** cycle, touch the “**BAKE**” pad and then the number pads to set the new temperature.

④ Check food for doneness at minimum time on recipe. Cook longer if necessary.

CLEAR OFF ⑤ Touch the “**CLEAR OFF**” pad when cooking is complete.

BAKING TIP

THE TYPE OF MARGARINE WILL AFFECT BAKING PERFORMANCE

Most recipes for baking have been developed using high fat products such as butter or margarine (80% fat). To decrease the fat, the recipe may not give the same results as with a higher fat product.

It can result in recipe failure if cakes, pies, pastries, cookies or candies are made with low fat spreads. The lower the fat content of a spread product, the more noticeable these differences become.

Federal standards require products labeled “margarine” to contain at least 80% fat by weight. Low fat spreads, on the other hand, contain less fat and more water. The high moisture content of these spreads affects the texture and flavor of baked goods. It can get best results with your old favorite recipes to use margarine, butter or stick spreads containing at least 70% vegetable oil.

PREHEATING AND PAN PLACEMENT

Preheat the oven if the recipe calls for it. To preheat, set the oven at the correct temperature. Preheating is necessary when convection baking and for good results when baking cakes, cookies, pastry and breads.

Baking results will be better if baking pans are centered in the oven as much as possible. If baking with more than one pan, place the pans so each has at least 1” to 1-1/2” of air space around it.

If cooking on multiple racks, place the oven racks in positions C and E (For 2 racks) Place the cookware as shown in Fig. 1, 2.

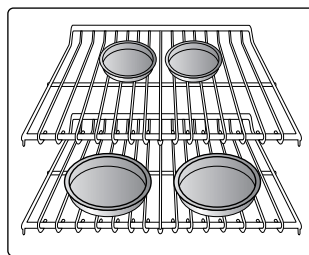

Fig. 1

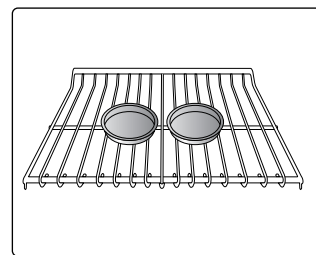

Fig. 2

Type of Food	Rack Position
Frozen pies (on cookie sheet)	B or C
Angel food cake, bundt or pound cakes	C
Biscuits, muffins, brownies, cookies, cupcakes, layer cakes, pies	D
Casseroles	D
Roasting	A

OPERATING INSTRUCTIONS

USING THE OVEN

HOW TO SET THE OVEN FOR BROILING

Your oven is designed for CLOSED DOOR broiling.

- 1 Place the food on the grid of the broiler pan.
- 2 Follow suggested rack positions in the **Broiling Guide**.
- 3 The oven door **must** be closed to begin broiling. The oven door **must** be closed during broiling.

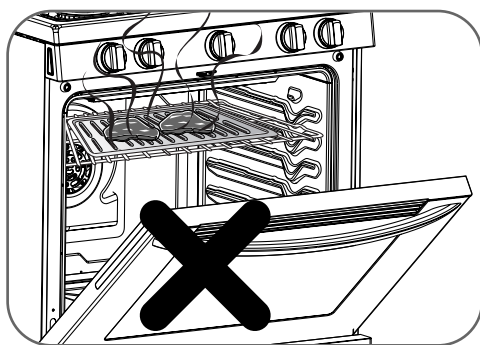

NOTE: If the oven door remains open for more than 15 seconds during broil the burner will shut off. The broil burner will automatically come back on once the door is closed.

BROIL

- 4 Touch the "**BROIL**" pad once for "**Hi**" and twice for "**Lo**".

START

- 5 Touch the "**START**" pad.

CLEAR OFF

- 6 When broiling is finished, touch the "**CLEAR OFF**" pad.

CAUTION:

- **DO NOT** use the broiler pan without the grid.
- **DO NOT** cover the broil pan or grid with aluminum foil. Exposed grease could ignite.
- To prevent food from contacting the broil burner and to prevent grease splattering, do not use the roasting rack when broiling.

Serve the food immediately, and place the pan outside the oven to cool during the meal for easiest cleaning.

Use **LO Broil** to cook foods such as poultry or thick cuts of meat thoroughly without over-browning them.



Always use the broiler pan and grid that came with your oven. It is designed to minimize smoking and spattering by trapping juices in the shielded lower part of the pan.

NOTE :

- Some smoke may occur during broiling. This is normal.

OPERATING INSTRUCTIONS

USING THE OVEN

BROILING GUIDE

Broiling times will be affected by the size, weight, thickness, starting temperature and your preference of doneness. This guide is based on meats at refrigerated temperatures.

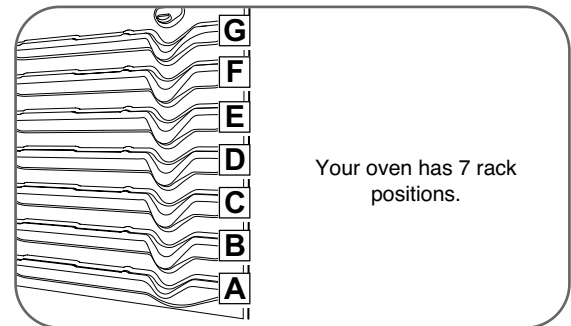

Food	Quantity and/or Thickness	Rack Position	First Side Time (min.)	Second Side Time (min.)	Comments
Ground Beef Well Done	1 lb. (4 patties) 1/2 to 3/4" thick	F	7~8	5-6	Space evenly. Up to 8 patties may be broiled at once.
Beef Steaks Rare Medium Well Done	1" thick 1 to 1 1/2 lb.	F F F	7 12 13	5 5-6 8-9	Steaks less than 1" thick cook through before browning. Pan frying is recommended. Slash fat.
Rare Medium Well Done	1 1/2" thick 2 to 2 1/2 lb.	D D D	10 12-15 25	6-7 10-12 16-18	
Bacon	1/2 lb. (about 8 thin slices)	D	8	3	Arrange in single layer.
Pork Chops Well Done	2 (1/2" thick.) 2 (1" thick) about 1 lb.	D D	10 13	8 8~9	Slash fat.
Lamb Chops Medium Well Done	2 (1" thick) about 10 to 12 oz.	E E	6 10	4-7 10	Slash fat.
Medium Well Done	2 (1 1/2" thick) about 1 lb	E E	10 17	4-6 12-14	
Chicken	1 whole 2 to 2 1/2 lbs., split lengthwise 4 bone-in breasts	B B	35-40 25-30	25 10-15	Brush each side with melted butter. Broil skin-side-down first.
Lobster Tails	2-4 6 to 8 oz. each	C	13-16	Do not turn over.	Cut through back of shell. Spread open. Brush with melted butter before broiling and after half of broiling time.
Fish Fillets	1/4 to 1/2" thick	E	7~8	6	Handle and turn very carefully. Brush with lemon butter before and during cooking, if desired. Preheat broiler to increase browning.
Ham Slices (precooked)	1" thick 1/2" thick	C D	10 7	5 4	Increase time 5 to 10 minutes per side for 1 1/2" thick or home-cured ham.

† The U.S. Department of Agriculture says "Rare beef is popular, but you should know that cooking it to only 140°F(60°C). means some food poisoning organisms may survive." (Source: *Safe Food Book, Your Kitchen Guide*. USDA Rev. June 1985.)

* See illustration for description of rack positions.

USING THE CLOCK AND TIMER

HOW TO SET THE CLOCK

The clock should be set to the correct time of day for the automatic oven timing functions to work properly. The time of day cannot be changed during cooking or self-clean mode.

CLOCK

- 1 Touch the “**CLOCK**” pad once to set.

1 2 3

- 2 Touch the **number** pads to enter the time. Touch the number pads the same way you read them. For example, to set 12:12, touch the number pads **1, 2, 1,** and **2** in that order.

If number pads are not touched within 30 seconds after you touch the “**CLOCK**” pad, the display reverts to the original setting. If this happens, touch the “**CLOCK**” pad and reenter the time of day.

START

- 3 Touch the “**START**” pad.

To check the time of day when the display is showing other information, simply touch the “**CLOCK**” pad.

HOW TO CHANGE HOUR MODE ON CLOCK (12HR OR 24HR)

Your control is set to use a 12-hour clock. If you would prefer to have a 24-hour time clock, follow the steps below.

CLOCK

- 1 Touch the “**CLOCK**” pad for 3 seconds.

1 2

- 2 Touch the number **1** pad for 12-hour, **2** pad for 24-hour.

START

- 3 Touch the “**START**” pad to accept the desired change.

HOW TO SET THE TIMER

The timer does not control oven operations. The maximum setting on the timer is 11 hours and 59 minutes.

TIMER ON/OFF

- 1 Touch the “**TIMER ON/OFF**” pad once for minutes and seconds, touch the pad twice for hours and minutes.

1 2 3

- 2 Touch the **number** pad to select the desired time. A maximum of 59 minutes can be set using the minutes and seconds function. To set times longer than 59 minutes use the hours and minute function (touch the pad twice).

NOTE: If you make a mistake, press the “**TIMER ON/OFF**” pad and begin again.

TIMER ON/OFF

- 3 Touch the “**TIMER ON/OFF**” pad to start the countdown.

NOTE: If “**TIMER ON/OFF**” is not pressed the timer will return to the time of day.

TIMER ON/OFF

- 4 When the timer reaches **:00**, “**End**” will show in the display. The clock will sound with timer alarm melody every 15 seconds until “**TIMER ON/OFF**” pad is touched.

NOTE: If the remaining time is not in the display, recall the remaining time by pressing the “**TIMER ON/OFF**”.

OPERATING INSTRUCTIONS

USING THE CLOCK AND TIMER (continued)

HOW TO CANCEL THE TIMER

Touch the “**TIMER ON/OFF**” pad.

POWER OUTAGE

If a flashing time is in the display, you have experienced a power failure. You will need to reset the clock time.

Touch the “**CLOCK**” pad once to reset. Enter the correct time of day by touching the appropriate number pads. Touch the “**START**” pad.

USING THE TIMED BAKING & ROASTING FEATURES

NOTE: DO NOT leave foods that spoil easily – such as milk, eggs, fish, stuffings, poultry and pork – more than 1 hour before or after cooking. Room temperature promotes the growth of harmful bacteria. Be sure that the oven light is off because heat from the bulb will speed harmful bacteria growth.

HOW TO SET AN IMMEDIATE START AND AUTOMATIC STOP

The oven will turn on immediately and cook for a selected length of time. At the end of the cooking time, the oven will turn off automatically.

BAKE

1 Touch the “**BAKE**” pad.

1 2 3

2 Touch the **number** pads to set the desired oven temperature.

COOK TIME

3 Touch the “**COOK TIME**” pad.

NOTE: If your recipe requires preheating, you may need to add additional time to the length of the cooking time.

1 2 3

4 Touch the **number** pads to set the desired length of cooking time. The cooking time you can set is between 1 minute to 11 hours and 59minutes. To enter a cooking time of 1 hr 30 minutes, touch **1, 3, 0**. The entered oven temperature and the cooking time will be shown in the display.

START

5 Touch the “**START**” pad.

The oven will turn **ON**, and the display will show the cooking time countdown and the changing temperature starting at 100°F(38°C). When the oven reaches the temperature you set, the preheat alarm melody will sound and the oven light will flash.

The oven will continue to cook for the set amount of time, then turn off automatically, unless the **WARM** feature was set. See the “**SETTING THE WARM FEATURE**” section.

After the oven turns off, the cook end melody will sound every minute until “**CLEAR OFF**” is touched.

CLEAR OFF

6 Touch the “**CLEAR OFF**” pad to clear the display. Remove the food from the oven. Remember, although the oven turns off automatically, food left in the oven will continue cooking after the oven turns off.

USING THE TIMED BAKING & ROASTING FEATURES (continued)

HOW TO SET A DELAYED START AND AUTOMATIC STOP

The oven will turn on at the time of day you set, cook for a specific length of time and then turn off automatically.

Be sure the clock shows the correct time of day.

BAKE

1 Touch the “**BAKE**” pad.

1 2 3

2 Touch the **number** pads to set the desired oven temperature.

COOK TIME

3 Touch the “**COOK TIME**” pad.

NOTE: If your recipe requires preheating, you may need to add additional time to the length of the cooking time.

1 2 3

4 Touch the **number** pads to set the desired length of cooking time. To enter a cooking time of 1 hr 30 minutes, touch **1, 3, 0**. The entered oven temperature and the cooking time will be shown in the display.

START TIME

5 Touch the “**START TIME**” pad.

1 2 3

6 Touch the **number** pads to set the time of day you want the oven to turn on and start cooking.

START

7 Touch the “**START**” pad.

NOTE: If you would like to check the times you have set, touch the “**START TIME**” pad to check the start time you have set or touch the “**COOK TIME**” pad to check the length of cooking time you have set.

The oven will turn **ON**, and the display will show the cooking time countdown and the changing temperature starting at 100°F(38°C). When the oven reaches the temperature you set, the preheat alarm melody will sound and the oven light will flash.

The oven will continue to cook for the set amount of time, then turn off automatically, unless the **WARM FEATURE** was set. See the “**SETTING THE WARM FEATURE**” section.

After the oven turns off, the end-of-cycle tone will sound.

CLEAR OFF

8 Touch the “**CLEAR OFF**” pad to clear the display. Remove the food from the oven. Remember, although the oven turns off automatically, food left in the oven will continue cooking after the oven turns off.

OPERATING INSTRUCTIONS

USING THE CONVECTION OVEN

The convection oven fan shuts off when the oven door is opened. **DO NOT** leave the door open for long periods of time during convection cooking.

To help you understand the difference between convection bake and roast and traditional bake and roast, here are some general guidelines.

The oven fan and the bake burner will not run simultaneously. The fan and the oven burner will cycle opposite of each other. For example during the preheat the fan will not run, but once the preheat has completed you will hear the fan run until the burner comes back on. This is **NORMAL**.

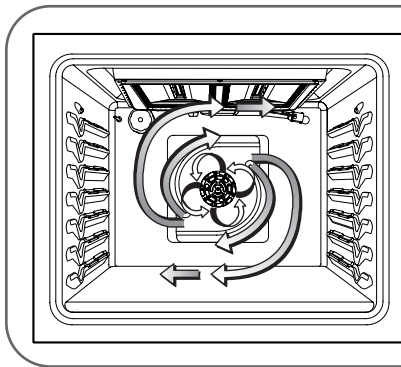

In a convection oven, a fan circulates hot air around the food. This circulating hot air is evenly distributed throughout the oven cavity. As a result, foods are evenly cooked and browned—often in less time than with regular bake.

CONVECTION ROAST

- Good for large tender cuts of meat, uncovered.

The convection fan circulates the heated air evenly around the food. Using the grid and broiler pan provided, heated air will be circulated over and around the food being roasted. The heated air seals in juices quickly for a moist and tender product while, at the same time, creating a rich golden brown exterior.

Roasts or poultry should be cooked on rack position (A).

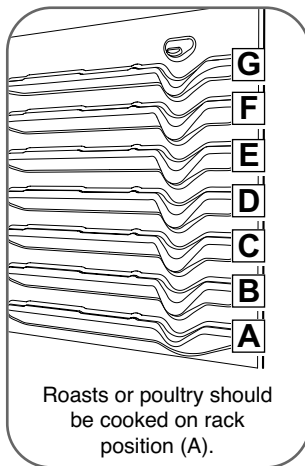

Roasts or poultry should be cooked on rack position (A).

CONVECTION BAKE

- Preheat the oven. See the “USING THE OVEN—PREHEATING AND PAN PLACEMENT” section.
- Ideal for foods cooked on multiple racks.
- Good for large quantities of baked foods.
- Good results with cookies, biscuits, brownies, cupcakes, cream puffs, sweet rolls, angel food cake and bread. The convection fan circulates the heated air evenly around the food.

Roasting Rack Instructions

When preparing meats for convection roasting, use the broiler pan and grid along with the roasting rack. The broiler pan will catch grease spills and the grid will help prevent grease splatters. The roasting rack will allow the heat to circulate around the meat.

⚠ CAUTION:

- **DO NOT** use the roasting rack when broiling.
 - To prevent food from coming in contact with the broil element and grease from splattering.
1. Place oven rack on bottom or next to the bottom rack position.
 2. Place the grid in the broiler pan. The roasting rack fits on the grid allowing the heated air to circulate under the food for even cooking and helps to increase browning on the underside. Make sure the roasting rack is securely seated on the grid in the broiler pan. **DO NOT** use the broiler pan without the grid. **DO NOT** cover the grid with aluminum foil.
 3. Position food (fat side up) on the roasting rack.
 4. Place the broiler pan on the oven rack.

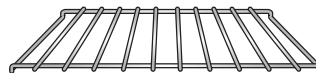

Roasting rack

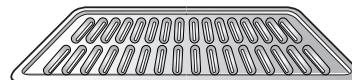

Grid

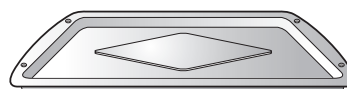

Broiler Pan

USING THE CONVECTION OVEN (continued)

AUTOMATIC RECIPE CONVERSION

You can use your favorite recipes in the convection oven.

When using **CONVECTION BAKE**, the **CONVECTION AUTO CONVERSION** feature will automatically convert the temperature from regular baking to **CONVECTION BAKE** temperatures. This feature will display the actual converted (reduced) temperature.



1 Touch the “**CONV. BAKE**” pad.



2 Using the **number** pad, enter the temperature recommended in the recipe. The display will show the temperature you entered from your recipe.



3 Touch the “**START**” pad.

CONV. BAKE will appear in the display and then show the converted temperature. After the preheat is complete, the display will show the converted oven temperature.

COOKWARE FOR CONVECTION COOKING

Check to see if your cookware leaves room for air circulation in the oven before using your convection oven. If you are baking with several pans, leave space between them. Also, be sure the pans do not touch each other or the walls of the oven.

Paper and Plastic

You can use heat-resistant paper and plastic containers that are recommended for use in regular ovens in convection ovens.



4 Touch the “**CLEAR OFF**” pad when baking is finished.

- Use pan size recommended in the recipe.
- Some package instructions for frozen casseroles, main dishes or baked goods have been developed using commercial convection ovens. For best results in this oven, preheat the oven and use the temperature, for regular baking, on the package.

NOTE:

- If a food manufacturer gives specific convection baking package instructions, program the **AUTO CONVERSION** temperature so that the preheated oven temperature reads the same as the temperature on the package instructions.

Metal and Glass

Any type of cookware will work in your convection oven. However, metal pans heat the fastest and are recommended for convection baking.

- Darkened or matte-finished pans will bake faster than shiny pans.
- Glass or ceramic pans cook more slowly.

When baking cookies, use a flat cookie sheet instead of a pan with low sides to get the best results.

For recipes like oven-baked chicken, use a pan with low sides. Hot air cannot circulate well around food in a pan with high sides.

OPERATING INSTRUCTIONS

USING THE CONVECTION OVEN (continued)

HOW TO SET THE OVEN FOR CONVECTION BAKING OR ROASTING

CONV. BAKE or **CONV. ROAST** **1** Touch the “**CONV. BAKE**” or “**CONV. ROAST**” pad.

1 2 3 **2** Touch the **number** pads to set the desired oven temperature.

START **3** Touch the “**START**” pad.

To change the oven temperature, touch the “**CONV. BAKE**” or “**CONV. ROAST**”, pad and then the number to set the new temperature.

When the oven starts to heat, the changing temperature, starting at 100°F (38°C), will be displayed. When the oven reaches the temperature you set, the preheat alarm melody will sound and the oven light will flash.

CLEAR OFF **4** Touch the “**CLEAR OFF**” pad when finished.

NOTES:

- You will hear a fan while cooking with convection. The fan will stop when the door is opened, but the heat will not turn off.
- The fan will not start until the preheat temperature is reached.

MULTI-RACK BAKING

You can bake foods with excellent results using multiple racks because heated air is circulated evenly throughout the oven.

Multi-rack baking may increase cook times slightly for some foods but the overall result is time saved. Cookies, muffins, biscuits and other quick breads give very good results with multi-rack baking.

When baking larger food items using 2 racks, place the first rack in position C and the second rack in position E.

When baking larger food items using 3 racks, place the first rack in position B, the second rack in position D and the third rack in position F.

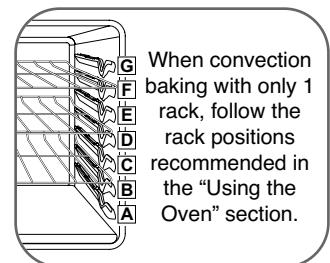

OPERATING INSTRUCTIONS

USING THE CONVECTION OVEN (continued)

CONVECTION ROASTING CHART

Meats		Minutes/Lb.	Oven Temp.	
Beef	Rib (3 to 5 lbs.)	Rare †	20–24	325°F(160°C)
		Medium	24–28	325°F(160°C)
		Well	28–32	325°F(160°C)
	Boneless Rib, Top Sirloin	Rare †	20–24	325°F(160°C)
Medium		24–28	325°F(160°C)	
Well		28–32	325°F(160°C)	
Beef Tenderloin	Rare †	10–14	325°F(160°C)	
	Medium	14–18	325°F(160°C)	
	Pot Roast (2½ to 3 lbs.) chuck, rump	35–45	300°F(150°C)	
Pork	Bone-in (3 to 5 lbs.)	23–27	325°F(160°C)	
	Boneless (3 to 5 lbs.)	23–27	325°F(160°C)	
	Pork Chops (½ to 1" thick)	2 chops	30–35 total	325°F(160°C)
4 chops		35–40 total	325°F(160°C)	
6 chops		40–45 total	325°F(160°C)	
Ham	Canned (3 lbs. fully cooked)	14–18	325°F(160°C)	
	Butt (5 lbs. fully cooked)	14–18	325°F(160°C)	
	Shank (5 lbs. fully cooked)	14–18	325°F(160°C)	
Lamb	Bone-in (3 to 5 lbs.)	Medium	17–20	325°F(160°C)
		Well	20–24	325°F(160°C)
	Boneless (3 to 5 lbs.)	Medium	17–20	325°F(160°C)
		Well	20–24	325°F(160°C)
Seafood	Fish, whole (3 to 5 lbs.)	30–40 total	400°F(205°C)	
	Lobster Tails (6 to 8 oz. each)	20–25 total	350°F(175°C)	
Poultry	Whole Chicken (2½ to 3½ lbs.)	24–26	350°F(175°C)	
	Cornish Hens Unstuffed (1 to 1½ lbs.)	50–55 total	350°F(175°C)	
		55–60 total	350°F(175°C)	
	Duckling (4 to 5 lbs.)	24–26	325°F(160°C)	
	Turkey, whole*	Unstuffed (10 to 16 lbs.)	8–11	325°F(160°C)
Unstuffed (18 to 24 lbs.)		7–10	325°F(160°C)	
	Turkey Breast (4 to 6 lbs.)	16–19	325°F(160°C)	

* Stuffed birds generally require 30–45 minutes additional roasting time. Shield legs and breast with foil to prevent overbrowning and drying of skin.

† The U.S. Department of Agriculture says "Rare beef is popular, but you should know that cooking it to only 140°F(60°C) means some food poisoning organisms may survive." (Source: *Safe Food Book, Your Kitchen Guide*, USDA Rev. June 1985.)

OPERATING INSTRUCTIONS

USING THE TIMED CONVECTION BAKING OR ROASTING FEATURES

NOTES:

- You will hear a fan while cooking with convection. The fan will stop when the door is opened, but the heat will not turn off.
- The fan will not start until the preheat temperature is reached.

- **DO NOT** leave foods that spoil easily – such as milk, eggs, fish, stuffings, poultry and pork – more than 1 hour before or after cooking. Room temperature promotes the growth of harmful bacteria. Be sure that the oven light is off because the heat from the bulb will speed harmful bacteria growth.

HOW TO SET AN IMMEDIATE START AND AUTOMATIC STOP

The oven will turn on immediately and cook for a selected length of time. At the end of the cooking time, the oven will turn off automatically.

 **1** Touch the “**CONV. BAKE**” or “**CONV. ROAST**” pad.

 **2** Touch the **number** pads to set the desired oven temperature.

 **3** Touch the “**COOK TIME**” pad.

NOTE: If your recipe requires preheating, you may need to add additional time to the length of the cooking time.

 **4** Touch the **number** pads to set the desired length of cooking time. The cooking time you can set is between 1 minute to 11 hours and 59minutes. To enter a cooking time of 1 hr 30 minutes, touch **1, 3, 0**.
The oven temperature that you set and the cooking time that you entered will be in the display.

 **5** Touch the “**START**” pad.

The oven will turn **ON**, and the display will show the cooking time countdown and the changing temperature starting at 100°F(38°C).

When the oven reaches the temperature you set, the preheat alarm melody will sound and the oven light will flash.

The oven will continue to cook for the set amount of time, then turn off automatically, unless the **WARM FEATURE** was set. See the “**SETTING THE WARM FEATURE**” section.

After the oven turns off, the cook end melody will sound every minute until “**CLEAR OFF**” is touched.

 **6** Touch the “**CLEAR OFF**” pad to clear the display. Remove the food from the oven. Remember, even though the oven turns off automatically, food left in the oven will continue cooking after the oven turns off.

USING THE TIMED CONVECTION BAKING OR ROASTING FEATURES (continued)

HOW TO SET A DELAYED START AND AUTOMATIC STOP

The oven will turn on at the time of day you set, cook for a specific length of time and then turn off automatically.

Be sure the clock shows the correct time of day.



- 1 Touch the “**CONV. BAKE**” or “**CONV. ROAST**” pad.



- 2 Touch the **number** pads to set the desired oven temperature.



- 3 Touch the “**COOK TIME**” pad.

NOTE: If your recipe requires preheating, you may need to add additional time to the length of the cooking time.



- 4 Touch the **number** pads to set the desired length of cooking time. To enter a cooking time of 1 hr 30 minutes, touch **1, 3, 0**. The oven temperature that you set and the cooking time that you entered will be in the display.



- 5 Touch the “**START TIME**” pad.



- 6 Touch the **number** pads to set the time of day you want the oven to turn on and start cooking.



- 7 Touch the “**START**” pad.

NOTE: If you would like to check the times you have set, touch the “**START TIME**” pad to check the start time you have set or touch the “**COOK TIME**” pad to check the length of cooking time you have set.

When the oven turns **ON** at the time of day you set, the display will show the cooking time countdown and the changing temperature starting at 100°F(38°C). When the oven reaches the temperature you set, the preheat alarm melody will sound and the oven light will flash.

The oven will continue to cook for the set amount of time, then turn off automatically, unless the **WARM FEATURE** was set. See the “**SETTING THE WARM FEATURE**” section.

After the oven turns off, the cook end melody will sound every minute until “**CLEAR OFF**” is touched.



- 8 Touch the “**CLEAR OFF**” pad to clear the display. Remove the food from the oven. Remember, even though the oven turns off automatically, food left in the oven will continue cooking after the oven turns off.

OPERATING INSTRUCTIONS

USING THE FAVORITE FEATURE

The **“FAVORITE”** pad is used to record and recall your favorite recipe settings. This feature will store up to 3 different settings.

- 1 Place the food in the oven.

FAVORITE

- 2 Touch the **“FAVORITE”** pad once for Bread, twice for Meat and 3 times for Chicken. Default temperature will appear in the display and COOK will flash.

Category	How to select	Default Temp. (may be changed)	Operating mode
1. Bread	Touch the “FAVORITE” pad once.	375° F(192° C)	Bake
2. Meat	Touch the “FAVORITE” pad twice.	325° F(165° C)	Convection Roast
3. Chicken	Touch the “FAVORITE” pad 3 times.	350° F(175° C)	Convection Roast

The Favorite Setting feature may be used with COOK TIME feature. This feature will not work with any other function including START TIME feature.

1 2 3

- 3 Touch the **number** pads to set the desired oven temperature within 25 seconds. This temperature will be stored next times.

START

- 4 Touch the **“START”** pad. A long beep will sound 3 times when the oven has reached the selected temperature.

NOTES:

- Only the temperature can be changed and stored with this feature.
- The stored temperature will remain in memory even in the event of a power loss.

SETTING THE WARM FEATURE

The WARM feature will maintain an oven temperature of 170°F(77°C). This feature should not be used to reheat cold foods. The Warm feature will keep cooked food warm for serving up to 3 hours after cooking has finished. After 3 hours the WARM feature will shut the oven OFF automatically. The Warm feature may be used without any other cooking operations or can be used after cooking has finished using TIMED BAKE (CONV. BAKE, CONV. ROAST) or DELAYED TIMED BAKE (CONV. BAKE, CONV. ROAST).

HOW TO SET WARM

WARM
OPTIONS:
HOLD 3 SEC.

- 1 Touch the **“WARM”** pad.

START

- 2 Touch the **“START”** pad.

CLEAR OFF

- 3 To turn Warm off, touch the **“CLEAR OFF”** at any time.

HOW TO SET WARM FEATURE WHEN TIMED COOKING

- 1 Set the cooking feature that you want to use: TIMED (BAKE, CONV. BAKE, CONV. ROAST), DELAY TIMED (BAKE, CONV. BAKE, CONV. ROAST) refer to the relevant previous page.

START

- 2 Touch the **“START”** pad.

WARM
OPTIONS:
HOLD 3 SEC.

- 3 Touch the **“WARM”** pad. WARM mode is set to turn on automatically after completing the TIMED COOKING or DELAY TIMED COOKING.

CLEAR OFF

- 4 To turn Warm off at any time touch the **“CLEAR OFF”** pad.

NOTE: If **“CLEAR OFF”** is touched prior to the delay functions starting all settings will be canceled.

SETTING THE PROOF FEATURE

The Proof feature maintains a warm environment for rising yeast leavened products before baking.

- 1 Place the covered dough in a dish in the oven on rack B or C.

NOTE: For best results, cover the dough with a cloth or with plastic wrap (the plastic may need to be anchored underneath the container so the oven fan will not blow it off).

PROOF

- 2 Touch the “**PROOF**” pad. PROOF will be displayed.

START

- 3 Touch the “**START**” pad.

CLEAR
OFF

- 4 When proofing is finished, touch the “**CLEAR OFF**” pad.

To avoid lowering the oven temperature and lengthening proofing time, do not open the oven door unnecessarily. Check bread products early to avoid over-proofing.

NOTES:

- **DO NOT** use the proofing mode for warming food or keeping food hot. The proofing oven temperature is not hot enough to hold foods at safe temperatures. Use the WARM feature to keep food warm.
- Proofing will not operate when oven is above 125°F(52°C). Oven is Hot will show in the display.

OPERATING INSTRUCTIONS

SPECIAL FEATURES OF YOUR OVEN CONTROL

Your new touch pad control has additional features that you may choose to use. The following pages describe these features and how you may activate them.

The special feature modes can only be activated while the display is showing the time of day.

HOW TO SET CONVECTION AUTO CONVERSION FEATURE

When using convection bake and roast, the Convection Auto Conversion feature will automatically convert entered regular baking temperatures to convection baking temperatures.

This feature is activated so that the display will show the actual converted (reduced) temperature. For example, if you enter a regular recipe temperature of 350°F(175°C) and touch the “**START**” pad, the display will show the converted temperature of 325°F(165°C).

They remain in the control’s memory until the steps are repeated.

When the display shows your choice, touch the “**START**” pad. The special features will remain in memory after a power failure.



- 1 Touch and hold the “**WARM**” pad for 3 seconds.
- 2 Touch the **number 1** pad to ENABLE or **2** pad to DISABLE.
- 3 Touch the “**START**” pad to accept the desired change.

SPECIAL FEATURES OF YOUR OVEN CONTROL

HOW TO ADJUST THE OVEN THERMOSTAT

You may find that your new oven cooks differently than the one it replaced. Use your new oven for a few weeks to become more familiar with it. If you still think your new oven is too hot or too cold, you can adjust the thermostat yourself.

DO NOT use thermometers, such as those found in grocery stores, to check the temperature setting of your oven. These thermometers may vary 20–40 degrees.

NOTE: This adjustment will not affect the broiling or the self-cleaning temperatures. The adjustment will be retained in memory after a power failure.

The oven temperature can be increased (+) or decreased (-) as much as 35°F or 19°C.

To increase(+) temperature adjustment

WARM
OPTIONS:
HOLD 3 SEC.

- 1 Touch and hold the “**WARM**” pad for 3 seconds. Then touch the “**WARM**” pad once and “Adj” will display.

1 2 3

- 2 Using the **number** pad, enter the temperature amount you wish to increase(+).
For example, to increase(+) the oven temperature 15, touch 1 and 5.

START

- 3 Touch the “**START**” pad to set the increased (+) temperature.

To decrease(-) temperature adjustment

WARM
OPTIONS:
HOLD 3 SEC.

- 1 Touch and hold the “**WARM**” pad for 3 seconds. Then touch the “**WARM**” pad once and “Adj” will display.

1 2 3

- 2 Using the **number** pad, enter the temperature amount you wish to decrease(-).
For example, to decrease(-) the oven temperature 15, touch 1 and 5.

WARM
OPTIONS:
HOLD 3 SEC.

- 3 Touch the “**WARM**” pad again, the decreased(-) temperature will appear in the display.

START

- 4 Touch the “**START**” pad to set the increased (+) temperature.

NOTE: Once the temperature is increased or decreased, the display will show the adjusted temperature until it is readjusted.

NOTE: The thermostat adjustment will change the temperature for bake, roast, convection bake and convection roast.

OPERATING INSTRUCTIONS

SPECIAL FEATURES OF YOUR OVEN CONTROL

HOW TO SELECT LANGUAGE

Your oven control is set to display in English but you may change this to display in Spanish or French.



- 1 Touch and hold the “**WARM**” pad for 3 seconds. Then touch the “**WARM**” pad twice and “Lng” will display.



- 2 Touch the **number 1** pad for English, **2** pad for Spanish or **3** pad for French.



- 3 Touch the “**START**” pad to accept the change.

HOW TO ADJUST BEEPER VOLUME

The beeper volume feature allows you to adjust the volumes to a more acceptable volume. There are four possible volume levels, loud, normal, low and mute.



- 1 Touch and hold the “**WARM**” pad for 3 seconds. Then touch the “**WARM**” pad 4 times and “BEEP” will display.



- 2 Touch the **number 1** pad for LOUD, **2** pad for NORMAL, **3** pad for LOW or **4** pad for MUTE.



- 3 Touch the “**START**” pad to accept the change.

HOW TO SET PREHEATING ALARM LIGHT ON/OFF

The interior oven light automatically turn on when the oven door is opened.

When oven reaches set-temperature after preheat, the oven notifies preheat-end by flashing oven lamp until the door is opened.

You can activate or deactivate the smart oven light feature. Default Setting is on.



- 1 Touch and hold the “**WARM**” pad for 3 seconds. Then touch the “**WARM**” pad 3 times and “PrE” will display.



- 2 Touch the **number 1** pad for ON or **2** pad for OFF.



- 3 Touch the “**START**” pad to accept the change.

HOW TO SELECT FAHRENHEIT OR CELSIUS TEMPERATURE

Your oven control is set to use the Fahrenheit temperature selections but you may change this to use the Celsius selections.



- 1 Touch and hold the “**WARM**” pad for 3 seconds. Then touch the “**WARM**” pad 5 times and “Unit” will display.



- 2 Touch the **number 1** pad for F(Fahrenheit) or **2** pad for C(Celsius).



- 3 Touch the “**START**” pad to accept the change.

OPERATING INSTRUCTIONS

USING THE ELECTRIC WARMING DRAWER (on some models)

The warming drawer will keep hot, cooked foods at serving temperature. Always start with hot food.

TO USE THE WARMING DRAWER

WARM DRAWER SET/OFF

1 Touch the “**WARM DRAWER SET/OFF**” pad. “**WARMER**” begins to blink.

1
or 2
or 3

2 On the number pad, touch 1 for Low, 2 for Medium or 3 for High. The warm drawer will begin to heat after a number pad is touched.

To cancel, touch the “**WARM DRAWER SET/OFF**” pad.

NOTES:

- Touching the “**CLEAR OFF**” pad does not turn the warming drawer off.
- The warming drawer cannot be used if the self clean is used.
- The warming drawer has three settings: 1, 2 and 3. These settings maintain different temperature levels in the warming drawer.
- The Warming Drawer will shut off automatically after 3 hours.

Number Pad	Setting
1	Lo (pies)
2	Med (casseroles)
3	Hi (meats)

WHEN USING THE WARMING DRAWER

The warming drawer will keep hot, cooked foods at serving temperature. Always start with hot food.

The warming drawer or pan with aluminum foil. Foil is an excellent heat insulator and will trap heat beneath it. This will upset the performance of the drawer and could damage the interior finish.

Allow approximately 25 minutes for the warming drawer to preheat.

- **DO NOT** leave liquid or water in the warming drawer.
- For moist foods, cover them with a lid or aluminum foil.
- For crisp foods, leave them uncovered.
- Food should be kept hot in its cooking container or transferred to a heat-safe serving dish.

CAUTION:

Plastic containers or plastic wrap will melt if in direct contact with the drawer, pan or a hot utensil. Melted plastic may not be removable and is not covered under your warranty.

- Remove serving spoons, etc., before placing containers in warming drawer.

ARRANGEING WARMING DRAWER RACK POSITIONS

The rack can be used in 2 ways:

- In the upright position to allow low profile food items to be placed both under and on top of the rack (for example, rolls or biscuits on top of the rack and a casserole dish underneath).
- **In the downward position** to allow you to place light weight food items and empty cookware (for example, rolls or pastries and dinner plates) on the rack. Set the Warming Drawer rack in either position as shown below (Fig. 1).

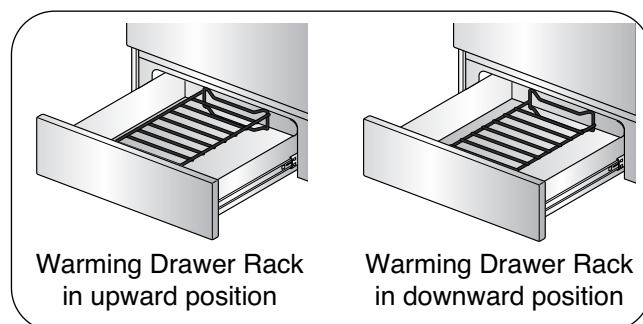

OPERATING INSTRUCTIONS

USING THE ELECTRIC WARMING DRAWER (on some models)

TEMPERATURE SELECTION CHART

If you keep several different foods hot, set the control to the food needing the highest setting.

- The quality of the food will be affected by the temperature, type and amount of food, and the time held.
- Food in heat-safe glass and glass-ceramic utensils may need a higher control setting as compared to food in metal utensils.
- Repeated opening of the drawer allows the hot air to escape and the food to cool.
- Allow extra time for the temperature inside the drawer to stabilize after adding items.
- With large loads it may be necessary to use a higher warming drawer setting and cover some of the cooked food items.
- **DO NOT** use plastic containers or plastic wrap.

Control Setting	Food Type
1(Low)	<ul style="list-style-type: none">• Rolls (soft)• Empty Dinner plates
2(Medium)	<ul style="list-style-type: none">• Gravies• Eggs• Biscuits• Pastries• Roasts (Beef, Pork, Lamb)• Casseroles• Vegetables• Rolls (hard)
3(High)	<ul style="list-style-type: none">• Bacon• Poultry• Pizza• Hamburger patties• Pork chops• Fried Foods

⚠ CAUTION:

DO NOT keep food in the warming drawer for more than two hours.

TO CRISP FOOD ITEMS

- Place food in a low sided dish or pan.
- Preheat on **1(Low)** setting.
- Check crispness after 45 minutes. Add time if needed.

TO WARM SERVING BOWLS AND PLATES

To warm serving bowls and plates, set the control on **1(Low)**.

- Use only heat-safe dishes.
- To heat fine china, please check with the manufacturer of the dishes for their maximum heat tolerance.
- You may warm empty serving dishes when preheating the drawer.

⚠ CAUTION:

Use pot holders or oven mitts when removing hot dishes. Dishes will be hot.

USING THE SELF-CLEANING OVEN

BEFORE A CLEAN CYCLE

When running a self clean cycle, it is recommended that a kitchen window be opened or the use of ventilation fan or hood be used.

Remove the oven racks, broiler pan, broiler grid, all cookware and any aluminum foil from the oven—they cannot withstand the high cleaning temperatures.

IMPORTANT: *The health of some birds is extremely sensitive to the fumes given off during the self-cleaning cycle of any range. Move birds to another well ventilated room.*

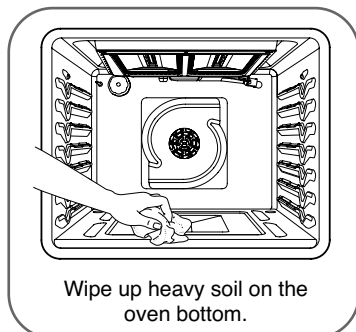

NOTES:

- Soil on the front frame of the range and outside the gasket on the door will need to be cleaned by hand. Clean these areas with hot water, soap-filled scouring pads or cleansers such as Soft Scrub. Rinse well with clean water and dry.
- **DO NOT** clean the gasket. The fiberglass material of the oven door gasket cannot withstand abrasion. It is essential for the gasket to remain intact. If you notice it becoming worn or frayed, replace it.
- Wipe up any heavy spillovers on the oven bottom.
- Make sure the oven light bulb cover is in place and the oven light is off.
- Use caution when opening the oven after the self-clean cycle has ended. The oven may still be hot.

HOW TO SET THE OVEN FOR CLEANING

**SELF
CLEAN**

- 1 Touch the “**SELF CLEAN**” pad once for a 3 hour cycle, twice for a 2 hour cycle or three times for a 4 hour cycle. A 3-hour self-clean is recommended for use when cleaning small, contained spills. A SELF CLEAN time of 4 hours is recommended for heavily soiled ovens.

START

- 2 Touch the “**START**” pad.

The door locks automatically. The display will show the clean time remaining. It will not be possible to open the oven door until the temperature drops below the lock temperature and the **DOOR LOCKED** light goes off.

The oven shuts off automatically when the clean cycle is complete.

- 3 When the **DOOR LOCKED** light is off, the door will unlock automatically.
- The words **DOOR LOCKED** will flash and the oven control will signal if you set the clean cycle and forget to close the oven door.
 - To stop a clean cycle, touch the “**CLEAR OFF**” pad. When the **DOOR LOCKED** light goes off indicating the oven has cooled below the locking temperature, open the door.

OPERATING INSTRUCTIONS

USING THE SELF-CLEANING OVEN

The oven door must be closed and all controls set correctly for the cycle to work properly.

HOW TO DELAY THE START OF CLEANING

Make sure the clock shows the correct time of day.

**SELF
CLEAN**

- 1 Touch the “**SELF CLEAN**” pad.
Select the desired self clean time by touching the “**SELF CLEAN**” pad.

**START
TIME**

- 2 Touch the “**START TIME**” pad.
Enter the desired Self-Clean starting time of day using the number pads.

START

- 3 Touch the “**START**” pad. “**DELAY**” and “**CLEAN**” will remain on.

The door locks automatically. The display will show the start time. Self-Cleaning cycle will turn on automatically at the set time. At that time the icon “**DELAY**” will go out. It will not be possible to open the oven door until the temperature drops below the lock temperature and the **DOOR LOCKED** light goes off.

⚠ WARNING:

During the self-clean cycle, the outside of the appliance can become very hot to the touch. Do not leave small children unattended near the appliance.

The oven shuts off automatically when the clean cycle is complete.

- When the **DOOR LOCKED** light is off, the door will unlock automatically.
- The words **DOOR LOCKED** will flash and the oven control will signal if you set the clean cycle and forget to close the oven door.
- To stop a clean cycle, touch the “**CLEAR OFF**” pad. When the **DOOR LOCKED** light goes off indicating the oven has cooled below the locking temperature, open the door.

⚠ CAUTION:

- **DO NOT** line the oven walls, oven racks, bottom or any other part of the range with aluminum foil. Doing so will stop heat distribution, produce poor baking results and cause permanent damage to the oven interior (aluminum foil will melt to the interior surface of the oven).
- Use caution when opening the door after the self-clean cycle is finished. The oven may still be **VERY HOT**.
- The health of some birds is extremely sensitive to the fumes given off during the self-cleaning cycle of any range. Move birds to another well-ventilated room.

AFTER A CLEAN CYCLE

- You may notice some white ash in the oven. Wipe it up with a damp cloth after the oven cools.
- If white spots remain, remove them with a soap-filled scouring pad and rinse thoroughly with a vinegar and water mixture.
- These deposits are usually a salt residue that cannot be removed by the clean cycle.
- If the oven is not clean after one clean cycle, repeat the cycle.
- You cannot set the oven for cooking until the oven is cool enough for the door to unlock.
- While the oven is self-cleaning, you can touch the **CLOCK** pad to display the time of day. To return to the clean countdown, touch the **COOK TIME** pad.
- If the racks become hard to slide, apply a small amount of vegetable oil or cooking oil to a paper towel and wipe the edges of the oven racks with the paper towel.

CARE AND CLEANING OF THE RANGE

CARE AND CLEANING

Make sure electrical power is off and all surfaces are cool before cleaning any part of the range.



If your range is pulled away from the wall for cleaning, servicing or any reason, ensure that the anti-tip device is re-engaged properly when the range is pushed back against the wall.



Failure to take this precaution could result in tipping of the range and cause injury.

CAUTION:

- **DO NOT** remove any parts from the cooktop until they have completely cooled and are safe to handle.
- **DO NOT** operate the surface burners without all burner parts and grates in place.

The electrode of the spark igniter is exposed when the burner head is removed. When turning a burner to “**LITE**”, all the burners spark. Do not attempt to disassemble or clean around any burner while another burner is on. An electric shock may result.

SEALED BURNER ASSEMBLIES

Turn all controls OFF before removing the burner parts. The burner grates, caps, and burner heads can be lifted off, making them easy to clean. The electrodes are not removable.

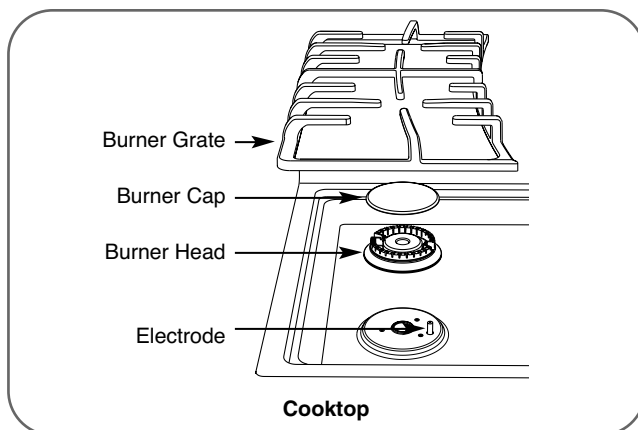

DUAL EXTRA BURNER ASSEMBLY (on some models)

The burner head, the outer cap and the inner cap can be lifted off, making it easy to clean. The burner electrode is not removable.

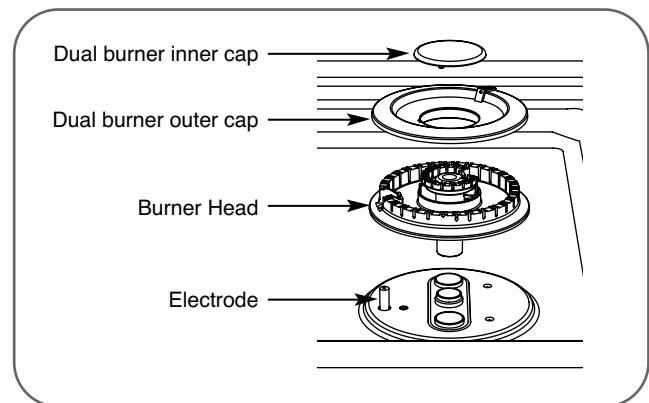

OVAL BURNER ASSEMBLY

The oval burner assembly can be lifted off, making it easy to clean. The burner electrode is not removable.

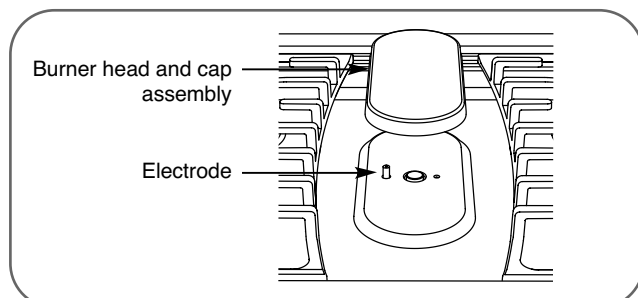

CARE AND CLEANING OF THE RANGE

BURNER CAPS AND HEADS

- **DO NOT** use bleach on product to clean.

BURNER CAPS

Lift off when cool. Wash burner caps in hot, soapy water and rinse with clean water. To remove burned on food particles, you may scour with a plastic scouring pad.

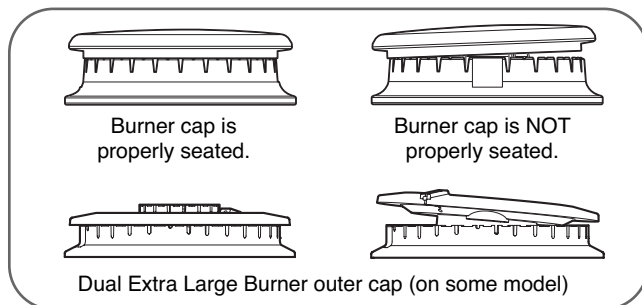

To place the dual extra large burner outer cap properly, make sure the slit in the burner cap is positioned over the assemble guide in the burner head.

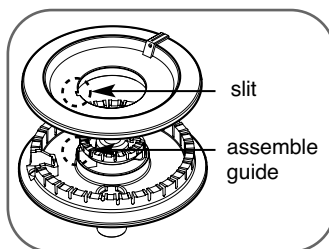

BURNER HEADS AND OVAL (CENTER) BURNER HEAD/CAP ASSEMBLY

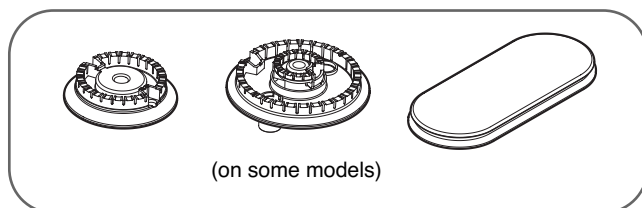

The burner heads and the oval burner head/cap assembly are removable. Simply lift them off the range for cleaning. For even and unhampered flame, the slits in the burner heads must be kept clean at all times. Clogged or dirty burner ports or electrodes will not allow the burner to operate properly. Any spill on or around an electrode must be carefully cleaned. Take care to not hit an electrode with anything hard or it could be damaged.

You should clean the burner caps and heads routinely, especially after bad spillovers which could clog the openings. Lift them off when they are cool.

If you want to remove burned-on food, soak the burner heads in a solution of mild liquid detergent and hot water for 20–30 minutes. For more stubborn stains, use a toothbrush.

NOTES:

- **DO NOT** use steel wool or scouring powders to clean the burners.
- Burners will not light if the cap is removed.

AFTER CLEANING

Before replacing the burner caps and burner heads shake out excess water and then dry them thoroughly.

REPLACEMENT

Replace burner heads and caps over the electrodes on the cooktop, in the correct locations according to their size.

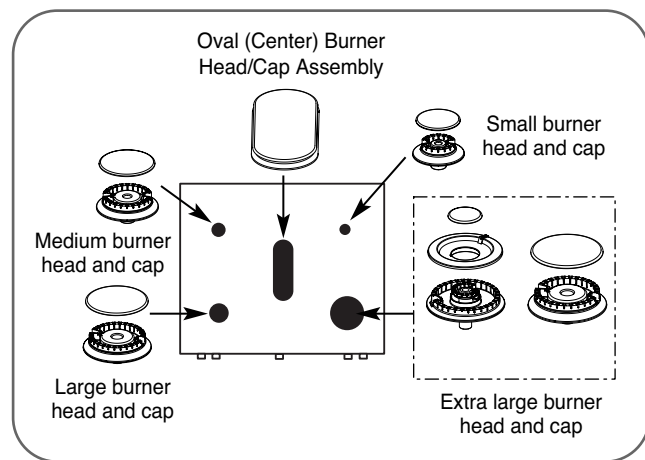

Make sure the hole in the burner head is positioned over the electrode.

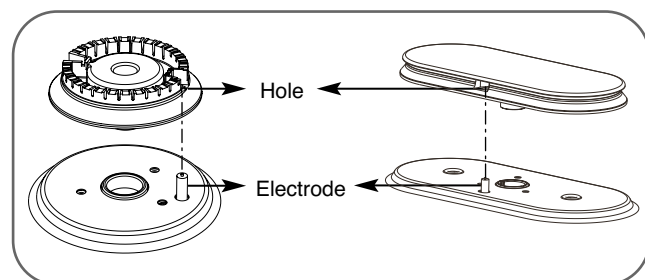

CARE AND CLEANING OF THE RANGE

BURNER GRATES

Your range has three professional-style grates.

For maximum stability, these grates should only be used in their proper position; Two side grates can be interchanged left to right and front to back. Center grate can be also interchanged front to back.

DO NOT operate a burner for an extended period of time without cookware on the grate. The finish on the grate may chip without cookware to absorb the heat.

Although they are durable, the grates will gradually lose their shine, regardless of the best care you can give them.

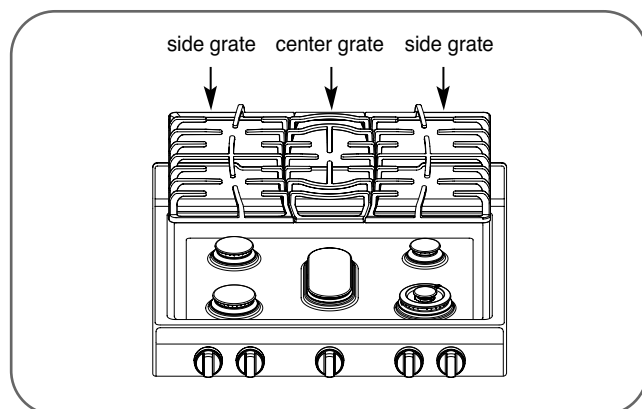

CLEANING

Lift the grates out when they have cooled. They should be washed regularly and, of course, after spillovers. Wash them in hot, soapy water and rinse with clean water. When replacing the grates, be sure they are positioned securely over the burners. Replace the grates so that continuous arcs are formed with the center ribs of all three grates. The grates are dishwasher safe.

NOTE: DO NOT clean the grates in a self-cleaning oven.

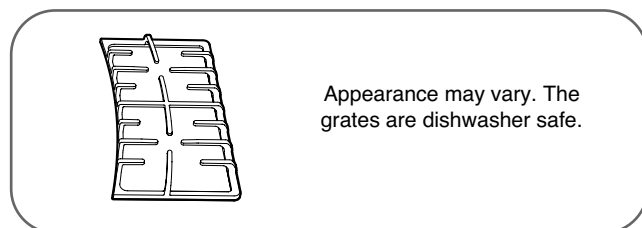

Appearance may vary. The grates are dishwasher safe.

COOKTOP SURFACE

To avoid damaging the porcelain enamel surface of the cooktop and to prevent it from becoming dull, clean up spills right away. Foods with a lot of acid such as tomatoes, sauerkraut, fruit juices, etc. or foods with high sugar content could cause a dull spot if allowed to set. Wash and rinse when the surface has cooled.

For other spills such as fat splatterings, etc., wash with soap and water once the surface has cooled. Then rinse and polish with a dry cloth.

NOTE: DO NOT lift the cooktop. Lifting the cooktop can lead to damage and improper operation of the range.

CARE AND CLEANING OF THE RANGE

STAINLESS STEEL SURFACES

DO NOT use a steel wool pad; it will scratch the surface.

To clean the stainless steel surface, use warm sudsy water or a stainless steel cleaner or polish. Always wipe the surface in the direction of the grain. Follow the cleaner instructions for cleaning the stainless steel surface.

To inquire about purchasing stainless steel appliance cleaner or polish, or to find the location of a dealer nearest you, please call our toll-free customer service number:

1-800-243-0000

or visit our website at:
us.lgservice.com

OVEN AIR VENTS

DO NOT block the vents and air openings of the range. They provide the air inlet and outlet that are necessary for the range to operate properly with correct combustion.

Air openings are located at the rear of the cooktop, at the top and bottom of the oven door, and at the bottom of the range, under the warming drawer.

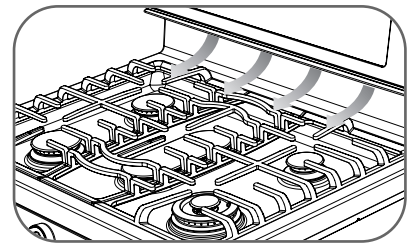

CONTROL PANEL

Clean up splatters with a damp cloth.

You may also use a glass cleaner.

Remove heavier soil with warm soapy water.

Do not use abrasives of any kind.

NOTE: To prevent activating the control panel during cleaning, unplug the range.

FRONT MANIFOLD PANEL AND KNOBS

It's better to clean the manifold panel after each use of the oven. Use a damp cloth to clean or rinse. For cleaning, use mild soap and water or a 50/50 solution of vinegar and water. For rinsing, use clean water. Polish dry with a soft cloth.

DO NOT use abrasive cleansers, strong liquid cleaners, plastic scouring pads or oven cleaners on the manifold panel—they will damage the finish.

DO NOT try to bend knobs by pulling them up or down or by hanging a towel or other such loads. This can damage the gas valve shaft.

The control knobs may be removed for easier cleaning.

Make sure the knobs are in the “OFF” positions and pull them straight off the stems for cleaning.

To replace the knobs, make sure the knob has the “OFF” position centered at the top and slide the knob directly onto the stem.

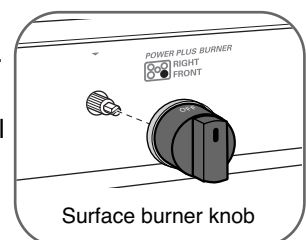

CARE AND CLEANING OF THE RANGE

OVEN DOOR

The oven door is removable, but it is heavy. You may need help removing and replacing the door.

⚠ CAUTION:

- Be careful when removing and lifting the door.
- DO NOT lift the door by the handle.
- The door is very heavy.

TO REMOVE THE DOOR

Step. 1

Open the door fully.

Step. 2

Pull the hinge locks down toward the door frame to the unlocked position.

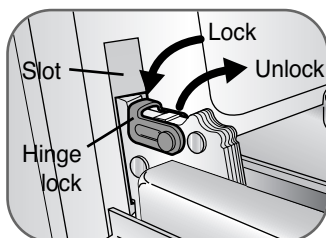

Step. 3

Firmly grasp both sides of the door at the top.

Step. 4

Close door to the door removal position, which is approximately 5 degrees.

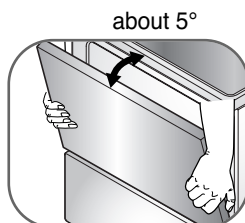

Step. 5

Lift door up and out until the hinge arm is clear of the slot.

TO REPLACE THE DOOR

Step. 1

Firmly grasp both sides of the door at the top.

Step. 2

With the door at the same angle as the removal position, seat the indentation of the hinge arm into the bottom edge of the hinge slot. The notch in the hinge arm must be fully seated into the bottom of the slot.

Step. 3

Open the door fully. If the door will not open fully, the indentation is not seated correctly in the bottom edge of the slot.

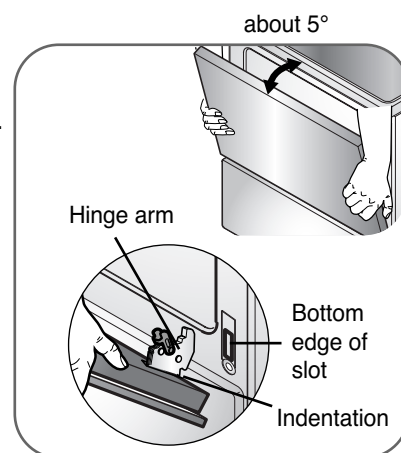

Step. 4

Push the hinge locks up against the front frame of the oven cavity to the locked position.

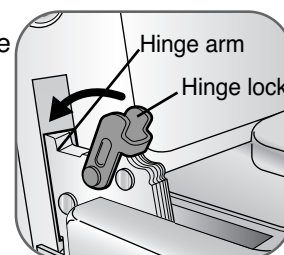

Step. 5

Close the oven door.

TO CLEAN THE INSIDE OF THE DOOR

- DO NOT allow excess water to run into any holes or slots in the door.
- Because the area inside the gasket in front of the cavity is cleaned during the self clean cycle, you do not need to clean this by hand.
- The area outside the gasket can be cleaned with a soap-filled plastic scouring pad.

TO CLEAN THE OUTSIDE OF THE DOOR

- Use soap and water to thoroughly clean the top, sides and front of the oven door. Rinse well. You may also use a glass cleaner to clean the glass on the outside of the door.
- Spillage of marinades, fruit juices, tomato sauces and basting materials containing acids may cause discoloration and should be wiped up immediately. When the surface is cool, clean and rinse.
- DO NOT use oven cleaners, cleansing powders or harsh abrasives on the outside of the door.

CARE AND CLEANING OF THE RANGE

OVEN BOTTOM

The oven bottom has a porcelain enamel finish. To make cleaning easier, protect the oven bottom from excessive spillovers by placing a cookie sheet on the rack below the rack you are cooking on. This is especially important when baking a fruit pie or other foods with a high acid content. Hot fruit fillings or other foods with a lot of acid (tomatoes, sauerkraut, sauces with vinegar or lemon juice) may cause pitting and damage to the porcelain enamel surface and should be wiped up right away.

DO NOT use aluminum foil on the bottom of the range. It can damage the oven cavity and block the air flow of the burner causing poor heat distribution.

To clean up spillovers, use soap and water, an abrasive cleaner or soap-filled scouring pad. Rinse well to remove any soap before self-cleaning.

BROILER PAN AND GRID

After broiling, remove the broiler pan from the oven. Remove the grid from the pan. Carefully pour out grease from the pan into a proper container. Wash and rinse the broiler pan and grid in hot water with a soap-filled or plastic scouring pad.

If food has been burned on the broiler pan or grid, spray the pan and grid with a detergent and let them soak. Use a paper towel or wash rag with warm water to clean.

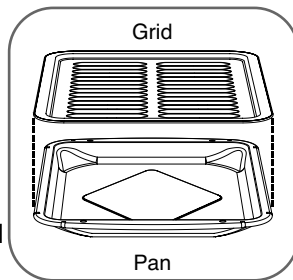

NOTES:

- The broiler pan and grid may be cleaned with a commercial oven cleaner.
- Both the broiler pan and grid are dishwasher safe.
- **DO NOT** store a soiled broiler pan and grid anywhere in the range.
- **DO NOT** clean the broiler pan or grid in a self-cleaning oven.

CARE AND CLEANING OF THE RANGE

OVEN RACKS AND DRAWER RACKS

If your oven is equipped with nickel oven racks, remove them from the oven before beginning the self-clean cycle.

To clean the oven racks, use an abrasive cleanser. After cleaning, rinse the racks with clean water and dry with a clean cloth. If the racks ever become hard to slide, wipe the rack edges or oven rack supports with vegetable oil.



Roast rack (some models)



Heavy duty (standard) rack

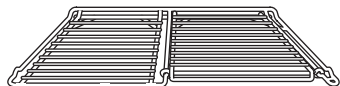

Split rack (some models)

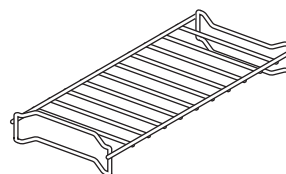

Warming drawer rack (some models)

OVEN LIGHT REPLACEMENT

The oven light is a standard 40-watt appliance bulb. It will come on when the oven door is open. When the oven door is closed, touch OVEN LIGHT to turn ON or OFF. It will not work during the Self-Clean cycle.

⚠ WARNING:

- Before replacing your oven light bulb, **DISCONNECT** the electrical power to the range at the main fuse or circuit breaker panel.
 - Failure to do so can result in severe personal injury, death or electrical shock.
- **Make sure oven and bulb are cool completely.**

TO REPLACE

- Make sure oven and bulb are cool.
- 1 Unplug range or disconnect power.
- 2 Turn the glass bulb cover in the back of the oven counterclockwise to remove.
- 3 Turn bulb counterclockwise to remove from socket.
- 4 Replace bulb and bulb cover by turning clockwise.
- 5 Plug in range or reconnect power.

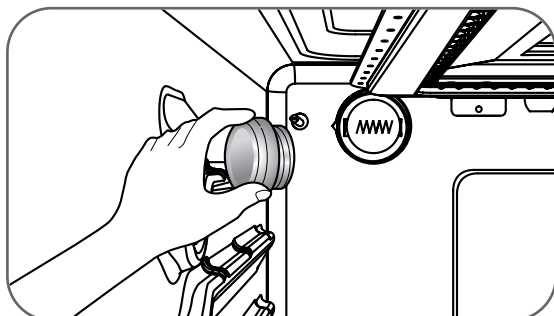

CARE AND CLEANING OF THE RANGE

REMOVABLE WARMING DRAWER

NOTE: Before performing any adjustments, cleaning or service, unplug the range. Make sure the warming drawer heating element is cool.

Most cleaning can be done with the drawer in place. However, the drawer may be removed if further cleaning is needed. Use soap and warm water to thoroughly clean.

TO REMOVE THE DRAWER:

- 1 Open the drawer to the fully opened position.
- 2 Remove the 2 screws (right and left sides). (refer to the illustration as below)
- 3 Locate glide lever on each side of drawer, push down on the left glide lever and pull up on the right glide lever.
- 4 Pull the Warming Drawer away from the range.

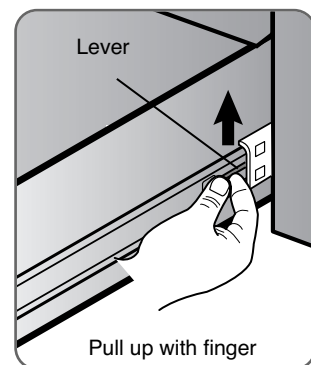
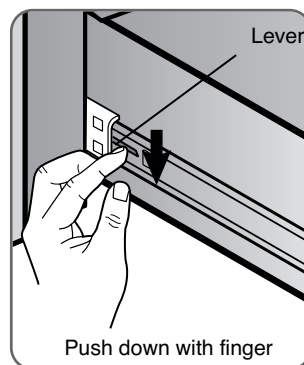
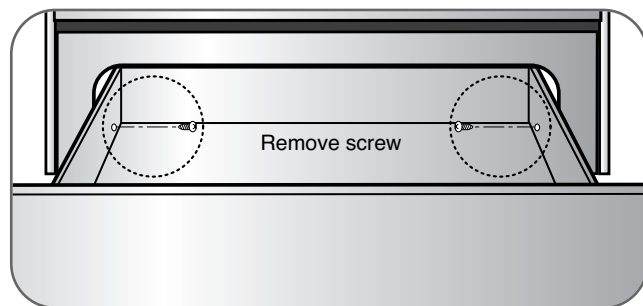

TO REPLACE THE DRAWER:

- 1 Pull the bearing glides to the front of the chassis glide.
- 2 Align the glide on each side of the drawer with the glide slots on the range.
- 3 Push the drawer into the range until levers "click" (approximately 2 inch). Pull the drawer open again to seat bearing glides into position.
If you do not hear the levers "click" or the bearing glides do not feel seated remove the drawer and repeat steps 2-4.
This will minimize possible damage to the bearing glides.
- 4 Replace the two screws.

BEFORE CALLING FOR SERVICE

Before you call for service, review this list. It may save you time and expense. This list includes common occurrences that are not the result of a defect in workmanship or materials.

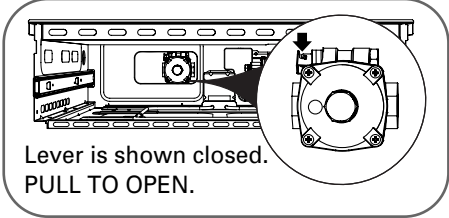
Problem	Possible Causes	Solutions
Top burners do not light or do not burn evenly	<ul style="list-style-type: none"> • The plug on range is not completely inserted in the electrical outlet. • Burner slits on the side of the burner may be clogged. • Improper burner assembly. 	<ul style="list-style-type: none"> • Make sure the electrical plug is inserted into a live, properly grounded outlet. • Remove the burners and clean them. Check the electrode area for burned-on food or grease. See the "CARE AND CLEANING OF THE RANGE" section. • Make sure the burner parts are installed correctly. See the "CARE AND CLEANING OF THE RANGE" section.
Burner flames very large or yellow	<ul style="list-style-type: none"> • Improper air to gas proportion. 	<ul style="list-style-type: none"> • If range is connected to LP gas, contact the technician who installed your range or made the conversion.
Surface burners light but the oven does not	<ul style="list-style-type: none"> • The oven gas shut-off valve may have accidentally been moved during cleaning or moving. 	<ul style="list-style-type: none"> • To check the oven gas shut-off valve, remove the warming drawer (see the "CARE AND CLEANING OF THE RANGE" section) and look for the gas shut-off lever at the back of the range.  <p>Lever is shown closed. PULL TO OPEN.</p>
Food does not bake or roast properly	<ul style="list-style-type: none"> • Improper oven controls setting. • Incorrect rack position. • Incorrect cookware or cookware of improper size being used. • Oven thermostat needs adjustment. • Clock not set correctly. • Aluminum foil used improperly in the oven. 	<ul style="list-style-type: none"> • See the "USING THE OVEN" section. • See the "USING THE OVEN" section. • See the "USING THE OVEN" section. • See the "HOW TO ADJUST THE OVEN THERMOSTAT" section. • See the "USING THE CLOCK AND TIMER" section. • See the "CARE AND CLEANING OF THE RANGE" section.

TROUBLESHOOTING

BEFORE CALLING FOR SERVICE

Problem	Possible Causes	Solutions
Food does not broil properly in the oven	<ul style="list-style-type: none"> • Improper oven controls setting. • Oven door not closed. • Incorrect rack position. • Food being cooked in a hot pan. • Cookware not suited for broiling. • Aluminum foil used on the broiling pan and grid has not been fitted properly and slit as recommended. 	<ul style="list-style-type: none"> • Make sure you touch the "BROIL HI/LO" pad. • See the "USING THE OVEN" section. • See the "BROILING GUIDE". • Use the broiling pan and grid that came with your range. Make sure it is cool. • Use the broiling pan and grid that came with your range. • See the "USING THE OVEN" section.
Oven temperature too hot or too cold	<ul style="list-style-type: none"> • Oven thermostat needs adjustment. 	<ul style="list-style-type: none"> • See the "HOW TO ADJUST THE OVEN THERMOSTAT" section.
Clock and timer does not work	<ul style="list-style-type: none"> • The plug on range is not completely inserted in the electrical outlet. • A fuse in your home may be blown or the circuit breaker tripped. • Improper oven controls setting. 	<ul style="list-style-type: none"> • Make sure the electrical plug is inserted into a live, properly grounded outlet. • Replace the fuse or reset the circuit breaker. • See the "USING THE CLOCK AND TIMER" section.
Oven light does not work	<ul style="list-style-type: none"> • The light bulb is loose or defective. • The plug on range is not completely inserted in the electrical outlet. 	<ul style="list-style-type: none"> • Tighten or replace the bulb. • Make sure the electrical plug is inserted into a live, properly grounded outlet.
Oven will not self-clean	<ul style="list-style-type: none"> • The oven temperature is too high to set a self-clean operation. • Improper oven controls setting. 	<ul style="list-style-type: none"> • Allow the range to cool to room temperature and reset the controls. • See the "USING THE SELF-CLEANING OVEN" section.
"Crackling" or "popping" sound	<ul style="list-style-type: none"> • This is the sound of the metal heating and cooling during both the cooking and cleaning functions. 	<ul style="list-style-type: none"> • This is normal.
Too much smoking during a self clean cycle.	<ul style="list-style-type: none"> • Too much soil. 	<ul style="list-style-type: none"> • Touch the "CLEAR OFF" pad. Open the windows to get rid of smoke from the room. Wait until the DOOR LOCKED light goes off. Wipe up the excess soil and reset the clean cycle.

BEFORE CALLING FOR SERVICE

Problem	Possible Causes	Solutions
Oven door will not open after a self-clean cycle	<ul style="list-style-type: none"> The oven temperature is too high. 	<ul style="list-style-type: none"> Allow the oven to cool below locking temperature. This can take up to 1 hr after the cycle is complete.
Oven not clean after a self-clean cycle	<ul style="list-style-type: none"> Improper oven controls setting. The oven was heavily soiled. 	<ul style="list-style-type: none"> See the Using the "USING THE SELF-CLEANING OVEN" section. Clean up heavy spillovers before beginning the self-clean cycle. Heavily soiled ovens may need to self-clean again or for a longer period of time.
"CLOSE DOOR TO CONTINUE BROILING" or "DOOR OPENED" appears in the display	<ul style="list-style-type: none"> The broil or self-clean cycle has been selected but the door is not closed. 	<ul style="list-style-type: none"> Close the oven door.
"DOOR LOCKED" light is on when you want to cook	<ul style="list-style-type: none"> The oven door is locked because the temperature inside the oven has not dropped below the locking temperature. 	<ul style="list-style-type: none"> Touch the "CLEAR OFF" pad. Allow the oven to cool.
Oven control beeps and displays any F code error.	<ul style="list-style-type: none"> You have "F3". You have "F11". If the function code repeats. 	<ul style="list-style-type: none"> Touch the "CLEAR OFF" pad. Allow the oven to cool for one hour. Put the oven back into operation. Check the main gas shut-off valve or the oven gas shut-off valve(see "Surface burners light but oven burner does not" column). Disconnect all power to the range for 5 minutes and then reconnect power. If the function error code repeats, call for service.
Oven racks are difficult to slide	<ul style="list-style-type: none"> The oven racks were cleaned in a self-clean cycle. 	<ul style="list-style-type: none"> Apply a small amount of vegetable oil to a paper towel and wipe the edges of the oven racks with the paper towel. Do not use lubricant sprays.
Power outage, clock flashes	<ul style="list-style-type: none"> Power outage or surge. 	<ul style="list-style-type: none"> Reset the clock. If the oven was in use, you must reset it by touching the "CLEAR OFF" pad, setting the clock and resetting any cooking function.
"Burning" or "oily" odor emitting from the vent	<ul style="list-style-type: none"> This is normal in a new oven and will disappear in time. 	<ul style="list-style-type: none"> To speed the process, set a self-clean cycle for a minimum of 3 hours. See the "USING THE SELF-CLEANING OVEN" section.
Strong odor	<ul style="list-style-type: none"> An odor from the insulation around the inside of the oven is normal for the first few times the oven is used. 	<ul style="list-style-type: none"> This is temporary.
Fan noise	<ul style="list-style-type: none"> The convection fan may turn on and off automatically. 	<ul style="list-style-type: none"> This is normal. The convection fan will shut off if the door is opened.

TROUBLESHOOTING

BEFORE CALLING FOR SERVICE

Problem	Possible Causes	Solutions
Convection fan not working (convection models)	<ul style="list-style-type: none">• Preheat temperature not reached.• Operates opposite the heating cycle.	<ul style="list-style-type: none">• Fan will start automatically once the preheat temperature is reached.• This is normal.
Drawer does not slide smoothly or drags	<ul style="list-style-type: none">• The drawer is out of alignment.• Drawer is over-loaded or load is unbalanced.	<ul style="list-style-type: none">• Fully extend the drawer and push it all the way in. See the <i>Care and Cleaning of the Range</i> section.• Reduce weight. Redistribute drawer contents.
Warming drawer will not work	<ul style="list-style-type: none">• A fuse in your home may be blown or the circuit breaker tripped.• The oven is self-cleaning.• Controls improperly set.	<ul style="list-style-type: none">• Replace the fuse or reset the circuit breaker.• Wait for the self-clean cycle to finish and the oven to cool.• See the <i>Using the Electric Warming Drawer</i> section.
Excessive condensation in the drawer	<ul style="list-style-type: none">• Liquid in drawer.• Uncovered foods.• Temperature setting too high.	<ul style="list-style-type: none">• Remove liquid.• Cover food with lid or aluminum foil.• Reduce temperature setting.
Food dries out in warming drawer	<ul style="list-style-type: none">• Moisture escaping.• Drawer not fully closed.	<ul style="list-style-type: none">• Cover food with lid or aluminum foil.• Push drawer in until latch engages.

LG GAS RANGE LIMITED WARRANTY – USA

LG Electronics Inc. will repair or replace your product, at LG's option, if it proves to be defective in material or workmanship under normal use, during the warranty period set forth below, effective from the date of original consumer purchase of the product. This limited warranty is good only to the original purchaser of the product and effective only when used in U.S.A.

WARRANTY PERIOD:	HOW SERVICE IS HANDLED:
One Year From the date of the original purchase	Any part of the oven which fails due to a defect in materials or workmanship. During this full one-year warranty , LG will also provide, free of charge , all labour and in-home service to replace the defective part.

THIS WARRANTY IS IN LIEU OF ANY OTHER WARRANTIES, EXPRESS OR IMPLIED, INCLUDING WITHOUT LIMITATION, ANY WARRANTY OF MERCHANTABILITY OR FITNESS FOR A PARTICULAR PURPOSE. TO THE EXTENT ANY IMPLIED WARRANTY IS REQUIRED BY LAW, IT IS LIMITED IN DURATION TO THE EXPRESS WARRANTY PERIOD ABOVE. LG WILL NOT BE LIABLE FOR ANY CONSEQUENTIAL, INDIRECT, OR INCIDENTAL DAMAGES OF ANY KIND, INCLUDING LOST REVENUES OR PROFITS, IN CONNECTION WITH THE PRODUCT. SOME STATES DO NOT ALLOW LIMITATION ON HOW LONG AN IMPLIED WARRANTY LASTS OR THE EXCLUSION OF INCIDENTAL OR CONSEQUENTIAL DAMAGES, SO THE ABOVE LIMITATIONS OR EXCLUSIONS MAY NOT APPLY TO YOU.

THIS LIMITED WARRANTY DOES NOT APPLY TO:

1. Service calls to correct the installation of your appliance, to instruct you how to use your appliance, to replace house fuses or correct house wiring, or to replace owner-accessible light bulbs.
2. Repairs when your appliance is used in other than normal, single-family household use.
3. Pickup and delivery. Your appliance is designed to be repairable in the home.
4. Damage resulting from accident, alteration, misuse, abuse, fire, flood, improper installation, acts of God, or use of products not approved by LG Corporation.
5. Repairs to parts or systems resulting from unauthorized modifications made to the appliance.
6. Replacement parts or repair labour costs for units operated outside the united states.
7. Any labour costs during the limited warranty period.

This warranty is extended to the original purchaser for products purchased for home use within the USA. In Alaska, the warranty excludes the cost of shipping or service calls to your home. Some states do not allow the exclusion or limitation of incidental or consequential damages, so this exclusion or limitation may not apply to you. This warranty gives you specific legal rights, and you may also have other rights which vary from states to states. To know what your legal rights are, consult your local or state consumer affairs or your state's Attorney General.

CUSTOMER ASSISTANCE INFORMATION:

To Prove Warranty Coverage	Retain your Sales Receipt to prove date of purchase. A copy of your Sales Receipt must be submitted at the time warranty service is provided.
To Obtain Nearest Authorized Service Center or Sales Dealer, or to Obtain Product, Customer, or Service Assistance	Call 1-800-243-0000 (Phone answered 24 hours - 365 days a year) and choose the appropriate prompt from the menu; or visit our website at: http://us.lgservice.com .

Memo

