



Internal Use Only

Website <http://us.lgservice.com>

# 30" Freestanding Electric Range

# **SERVICE MANUAL**

**MODEL: LSE3092ST**

**CAUTION**

BEFORE SERVICING THE UNIT, READ THE SAFETY PRECAUTIONS IN THIS MANUAL.

P/NO : MFL62114802

December, 2009  
Printed in Korea

# FORWARD

This LG Service Manual, “ 30” Freestanding Self-Cleaning Electric Range,” provides the technician with information on the operation and service of the Freestanding Self-Cleaning Electric Range. It is to be used as a training Service Manual. For specific information on the model being serviced, refer to the “Owner’s Manual” or “Tech Sheet” provided with the electric range.

## SAFETY PRECAUTIONS

- Repairs of the appliance should be carried out by a licensed technician only. Incorrect repairs may result in dangerous situations. If you need repairs, contact an LG Service Center or your dealer.
- If the power cord is defective, it must be replaced by a qualified service agent with a UL listed range cord.
- Electrical leads and cables should not be allowed to touch the oven.
- Rating plate is located on the left side of lower oven.
- The power supply of the appliance should be turned off when it is being repaired.

### **WARNING**

- **DISCONNECT power supply cord from the outlet before servicing.**
- **Replace all panels and parts before operating.**
- **RECONNECT all grounding devices.**
  - Failure to do so can result in severe personal injury, death or electrical shock.
- **DO NOT Touch when the oven operates.**
  - The interior parts will be very hot.

LG Electronics assumes no responsibility for any repairs made on our products by anyone other than Authorized Service Technicians.

# TABLE OF CONTENTS

	(PAGE)
<b>GENERAL</b> .....	<b>1-1 ~ 1-5</b>
• Important safety instructions .....	1-1 ~ 1-3
• Model & Serial number label and tech sheet locations .....	1-4
• Specifications .....	1-5
<b>USING YOUR RANGE</b> .....	<b>2-1 ~ 2-6</b>
• General information .....	2-1
• Control panel features .....	2-2 ~ 2-6
- To turn on a single surface unit (Left Rear, Right Rear)	
- To turn on a dual surface unit (Left Front)	
- To set the warming zone (Center Rear)	
- To turn on a TRIIPLE surface uni(Right Front)	
- Setting the clock	
- Start, Clear/Off and On/Off PAD	
- To turn On/Off the oven light	
- Time On/Off	
- Special function:6type of catebory	
1) Convection auto conversion	
2) Thermostat adjustment	
3) Language selection(English or French)	
4) Preheating alarm light On/Off	
5) Beeper volume	
6) Temperature unit (°F or °C)	
- Bake, Timed bake, Delayed timed bake	
- Biroil	
- Convection bake	
- Convection roast	
- Favorites	
- Healtier roast	
- Warm/Proof	
- Oven lockout	
- Changing hour mode on clock(12HR, 24HR)	
- Self-clean	
• Lower oven drawer .....	2-6
<b>COMPONENT ACCESS</b> .....	<b>3-1 ~ 3-22</b>
• Component Locations .....	3-1
• Removing the Back cover .....	3-2
• Removeing the Oven real PCB, Power PCB, Power real and Surge filter.....	3-3
• Removing the Controller .....	3-4
• Removing the Main PCB and Key PCB Assembly .....	3-5
• Removing the KNOB and Infinite Switch .....	3-6
• Removing the Ceramic Glass Cooktop, The Surface Element and The HOT Surface Lamp .....	3-7, 3-8, 3-9
• Removing the Broil Element .....	3-10
• Removing the Hidden Bake Element .....	3-11
• Removing the Convecton Element, Fanblade and Fanmoter .....	3-12
• Removing the Oven Light & Socket Assembly .....	3-13
• Removing the Latch Drive Assembly .....	3-14
• Removing the Oven Temperature Sensors .....	3-15
• Removing & Replacinc the LIFT-OFF Oven Door .....	3-16
• Removing the Oven Door Gasket .....	3-16
• Removing a Side Panel .....	3-17
• Removing the Lower Oven Element .....	3-18
• Removing the Variable Thermostat .....	3-19
• Removing the Oven Door Handle & Glass .....	3-20, 3-21
• Removing the Oven Door Gasket .....	3-22

**COMPONENT TEST ..... 4-1 ~ 4-16**

- Convection Motor ..... 4-1
- Door locking Motor ..... 4-2
- Micro Switch (normally open type) ..... 4-2
- LVT ..... 4-2
- Oven Sensor ..... 4-3
- Door switchr ..... 4-3
- Broil heater ..... 4-3
- Bake heater ..... 4-4
- Convection heater ..... 4-4
- Drawer Upper heater ..... 4-4
- Drawer Lower heater ..... 4-4
- Oven lamp ..... 4-5
- Infinite switch(Single units):LF switch, LR switch, RR switch ..... 4-6
- Infinite switch(Single units):CR Switch,RR switch ..... 4-7
- Infinite switch(Doable units):LF switch ..... 4-8
- Infinite switch(Single units):LF switch, LR switch, RR switch ..... 4-9
- Infinite switch(Triple units):RF switch ..... 4-10, 4-11
- Variable Thermostat:Lower oven switch ..... 4-12
- Single surface units:Left Rear (LR) and Right Rear(RR) Element ..... 4-13
- Center Rear(CR) Element:Warming Zone(Plane Heater) ..... 4-14
- Dual surface units:Left Front(LF) Element ..... 4-15
- Triple surface unit:Right Front(RF) Element..... 4-16

**COMPOSITION OF CONTROL ..... 5-1 ~ 5-3**

- Main PCB ..... 5-2
- Power PCB..... 5-2
- Relay PCB ..... 5-3
- Key PCB ..... 5-3

**FAILURE MODE FLOW CHART ..... 6-1 ~ 6-14**

- Power Failed(Dead), No display? ..... 6-1 ~ 6-3
- Oven does not heat, F-11 ..... 6-4 ~ 6-6
- Door Lock System Failure,F-10? ..... 6-7 ~ 6-8
- Sensing Fail, F-1, F-2? ..... 6-9 ~ 6-10
- Oven too hot, F-6, F-16? ..... 6-11 ~ 6-13
- F-3 error (Touch-sensor key error)Or Key does not input ..... 6-14

**APPENDIX ..... 7-1**

**TROUBLE SHOOTING ..... 8-1 ~ 8-3**

**SCHEMATIC DIAGRAM ..... 9-1**

- STRIP CIRCUITS ..... 9-2 ~ 9-4

**EXPLODED VIEW ..... 10-1 ~ 10-6**

**REPLACEMENT PARTS LIST ..... 11-1 ~ 11-9**



# GENERAL

## IMPORTANT SAFETY INSTRUCTIONS

Read and follow all instructions before using your oven to prevent the risk of fire, electric shock, injury to person, or damage when using the range. This guide don't cover all possible conditions that may occur. For further assistance contact your service agent or manufacturer.



This is the safety alert symbol. This symbol alerts you to potential hazards that can kill or hurt you and others. All safety messages will follow the safety alert symbol and either the word "WARNING" or "CAUTION". These word means :



### **WARNING**

This symbol will alert you to hazards or unsafe practices which could cause serious bodily harm or death.



### **CAUTION**

This symbol will alert you to hazards or unsafe practices which could cause bodily injury or property damage.



### **WARNING**

- **DO NOT step or sit on the door and install the Anti-Tip Bracket packed with range.**
  - The range could be tipped and injury might result from spilled hot liquid, food, or the range itself.
  - If the range is pulled away from the wall for cleaning, service, or any other reason, ensure that the Anti-Tip Device is properly reengaged when the range is pushed back against the wall.
- **DISCONNECT power supply cord from the outlet before servicing.**
- **Replace all panels and parts before operating.**
- **RECONNECT all grounding devices.**
  - Failure to do so can result in severe personal injury, death or electrical shock.
- **DO NOT touch heating elements or interior surfaces of oven.**
  - Heating element may be hot even though they are dark in color.
  - Interior surfaces of an oven become hot enough to cause burns.
- **During and after use, do not touch, or let clothing or other flammable materials contact heating elements or interior surfaces of oven until they have had sufficient time to cool.**
  - Other surfaces of the appliance may become hot enough to cause burns among these surfaces are oven vent openings and surfaces near these openings, oven doors, and windows of oven doors.
- **DO NOT store items of interest to children in cabinets above a range.**
  - Children climbing on the range to reach items could be seriously injured.



### **CAUTION**

- **Always use Pot Holders or oven mitts when removing food from the Lower Oven.**
  - You can be burned as cookware and plates will be hot.
- **Be careful when you work on the electric range handling the sheet metal part.**
  - Sharp edge may be present and you can cut yourself.
- **Be careful not to bend the fan blade**
  - Failure to do so can result in vibration, noise, and poor performance of convection when operating.
- **Be careful not to scratch or chip the oven liner paint when you remove the oven light socket in the next step.**
- **Turn power OFF before removing the Lower Oven.**
- **Be careful when removing and lifting the door.**
- **DO NOT lift the door by the handle.**
  - Failure to do so can result in personal injury as the door is very heavy.

# GENERAL

## IMPORTANT SAFETY INSTRUCTIONS

- Be sure your appliance is properly installed and grounded by a qualified technician.
- Do not repair or replace any part of the appliance unless specifically recommended in the manual. All other servicing should be referred to a qualified technician.
- Always disconnect power to appliance before servicing by removing the fuse or switching off the circuit breaker

### **WARNING**



- **DO NOT step or sit on the door and install the Anti-Tip Bracket packed with range.**
  - The range could be tipped and injury might result from spilled hot liquid, food, or the range itself.
  - If the range is pulled away from the wall for cleaning, service, or any other reason, ensure that the Anti-Tip Device is properly reengaged when the range is pushed back against the wall.

To reduce the risk of tipping of the range, the range must be secured by properly installed anti-tip devices. To check if the bracket is installed properly,

- rasp the rear edge of the Range and carefully attempt to tilt it forward.  
verify that the anti-tip devices are engaged.
- Refer to the installation manual for proper anti-tip bracket installation.

### **WARNING**

- **DO NOT touch heating elements or interior surfaces of oven.**
  - Heating element may be hot even though they are dark in color.
  - Interior surfaces of an oven become hot enough to cause burns.
- **During and after use, do not touch, or let clothing or other flammable materials contact heating elements or interior surfaces of oven until they have had sufficient time to cool.**
  - Other surfaces of the appliance may become hot enough to cause burns among these surfaces are oven vent openings and surfaces near these openings, oven doors, and windows of oven doors.

### **WARNING**

- **DO NOT store items of interest to children in cabinets above a range.**
  - Children climbing on the range to reach items could be seriously injured.

# GENERAL

## IMPORTANT SAFETY INSTRUCTIONS

- **Do Not Leave Children Alone** - Children should not be left alone or unattended in area where appliance is in use. They should never be allowed to sit or stand on any part of the appliance.
- **Never Use Your Appliance for Warming or Heating the Room.**
- **Storage in or on Appliance** – Flammable materials should not be stored in an oven or near surface units. Be sure all packing materials are removed from the appliance before operating it. Keep plastics, clothes and paper away from parts of the appliance that may become hot
- **Wear Proper Apparel** – Loose-fitting or hanging garments should never be worn while using the appliance.
- **Do Not Use Water on Grease Fires** – Turn off oven to avoid spreading the flame. Smother the fire or flame by closing the door or use dry chemical, baking soda or foam-type extinguisher.
- **Use Only Dry Potholders** – Moist or damp potholders on hot surfaces may result in burns from steam. Do not let potholder touch hot heating elements. Do not use a towel or other bulky cloth.

### **WARNING**

- **DISCONNECT power supply cord from the outlet before servicing.**
- **Replace all panels and parts before operating.**
- **RECONNECT all grounding devices.**  
- Failure to do so can result in severe personal injury, death or electrical shock.

## SURFACE COOKING UNITS

- **Use Proper Pan Size** – This appliance is equipped with one or more surface units of different sizes. Select utensils having flat bottoms large enough to cover the surface unit heating element. The use of undersized utensils will expose a portion of the heating element to direct contact and may result in ignition of clothing. Proper relationship of utensil to burner will also improve efficiency.
- **Never Leave Surface Units Unattended at High Heat Settings** – Boil overs may cause smoking and greasy spillovers may ignite.
- **Make Sure Reflector Pans or Drip Bowls Are in Place** – Absence of these pans or bowls during cooking may subject wiring or components underneath to damage.
- **Protective Liners** – Do not use aluminum foil to line surface unit drip bowls or oven bottoms, except as suggested in the manual. Improper installation of these liners may result in a risk of electric shock, or fire.
- **Glazed Cooking Utensils** – Only certain types of glass, glass/ceramic, ceramic, earthenware, or other glazed utensils are suitable for range-top service without breaking due to the sudden change in temperature.
- **Utensil Handles Should Be Turned Inward and Not Extend Over Adjacent Surface Units** – To reduce the risk of burns, ignition of flammable materials, and spillage due to unintentional contact with the utensil, the handle of a utensil should be positioned so that it is turned inward, and does not extend over adjacent surface units.
- **Do Not Soak Removable Heating Elements** – Heating elements should never be immersed in water.
- Be sure you know which control pads operate each surface unit. Make sure you turned on the correct surface unit.

## SELF-CLEAN OVENS

- **Do Not Clean Door Gasket** – The door gasket is essential for a good seal. Care should be taken not to rub, damage, or move the gasket.
- **Do Not Use Oven Cleaners** – No commercial oven cleaner or oven liner protective coating of any kind should be used in or around any part of the oven.
- **Clean in the self-clean cycle only parts listed in this manual.** Before self-cleaning the oven, remove the broiler pan and any utensils from the oven.
- **Never keep pet birds in the kitchen** – the health of birds is extremely sensitive to the fumes released during an oven self-clean cycle. Fumes may be harmful or fatal to birds. Move birds to well-ventilated room.
- **Important Instruction** – In the event the self-clean mode “F” code goes on, or three long beeps sound, oven is malfunctioning in the self-clean mode. Turn off or disconnect appliance from power supply and have serviced by a qualified technician.

## VENTILATING HOODS:

- **Clean Ventilating Hoods Frequently** – Grease should not be allowed to accumulate on hood or filter.
- **When flaming foods under the hood, turn the fan on.**

## OVEN

- **Use Care When Opening Door** – Let hot air or steam escape before you remove or replace food in the oven
- **Do Not Heat Unopened Food Containers** – Build-up of pressure may cause container to burst and result in injury.
- **Keep Oven Vent Ducts Unobstructed** – the oven vent is located below the control panel. this area could become hot during oven use. Never block this vent and never place plastic or heat-sensitive items on vent
- **Placement of Oven Racks** – Always place oven racks in desired location while oven is cool. If rack must be moved while oven is hot, do not let potholder contact hot heating element in oven.
- **Do Not** allow aluminum foil or meat probe to contact heating elements.

## GLASS/CERAMIC COOKING SURFACES

- **Do Not Cook on Broken Cook-Top** – If cook-top should break, cleaning solutions and spillovers may penetrate the broken cook-top and create a risk of electric shock. Contact a qualified technician immediately.
- **Clean Cook-Top With Caution** – If a wet sponge or cloth is used to wipe spills on a hot cooking area, be careful to avoid steam burn. Some cleaners can produce noxious fumes if applied to a hot surface.

## DEEP FAT FRYERS:

- Use extreme caution when moving the grease kettle or disposing of hot grease.

# GENERAL

## MODEL & SERIAL NUMBER LABEL AND TECH SHEET LOCATIONS

The Model/Serial Number label and Tech Sheet locations are shown below.

Model & Serial  
Number Location



Tech Sheet Location  
(On Low Rear Cover)



# GENERAL

## SPECIFICATIONS

Model Number		LSE3092ST
Category		Convection
<b>Overall</b>	Width	30"
	Installation type	Freestanding
	Color availability	STS
<b>Control</b>	Oven	Glass Touch
	Cooktop	Knob
	Display	Scroll VFD
	Electronic clock & timer	Yes
	Control lock capability	Yes
	Audible preheat signal	Yes
	Special function	Option(6 categories) 1. Convection auto conversion On/Off 2. Thermostat Adjustment 3. Language -English or Spanish 4. Preheating alarm light On/Off 5. Beeper Volume (loud, normal, low, mute) 6. Temperature unit (F / C)
<b>Cooktop</b>	Material	Ceramic glass
	# of element	5
<b>Power</b>	LR	6"-1.2kw
	RR	6"-1.2kw
	CR	warming zone - 100w
	LF	9"Dual(6"/9" - 1.4/3.0kw)
	RF	12"Triple(6"/9"/12"-1.1/2.2/3.0kw)
<b>Oven</b>	Capacity(cu.ft)	<b>5.4</b>
	Broil element	4000 watts
	Bake element	3400 watts
	Convection System	Yes
	-Convection element	Yes (700w x 2, 240v)
	Interior oven light	120V, 40Watts
	Proof	Yes
	Cook & warm	Yes
	Favorites	Yes 1. Bread 2. Meat 3. Chicken
	Healthier Roast	Yes (1.Beef, 2.Pork, 3.Lamb, 4.Chicken, 5.Turkey)
	Door lockout	Yes
	Broiler pan	Yes
	<b>Drawer</b>	Type
Element		1,200 watts (Upper heater - 400W, Lower heater – 800W)
Rack		Yes
<b>Dimensions (inch)</b>	Oven Interior(W x H x D)	24 1/2 x 19-11/16
	Exterior - Width	29 7/8
	Exterior - Height	36 (cooktop)
	Exterior - Depth	26-3/8 (Door), 28-7/8 (with handle)
	Net weight: Lbs (Kg)	216 lbs (98kg)
<b>Power</b>	Rating	15.3Kw(120/240V) / 11.5Kw(120/208V)



# USING YOUR RANGE

## GENERAL INFORMATION

### Rating Label

Model numbers are recorded on the rating label. Rating label is located on the lower front left corner of the oven frame. It can be seen by opening the drawer. Before ordering parts, write down the correct model and serial number from rating label. This avoids incorrect shipments and delays. Please refer to parts reference material when ordering replacement parts.

### Functional Operation

#### Bake Mode

Top and hidden bottom elements operate during bake. Bake can be used to cook foods which are normally baked. Oven must be preheated.

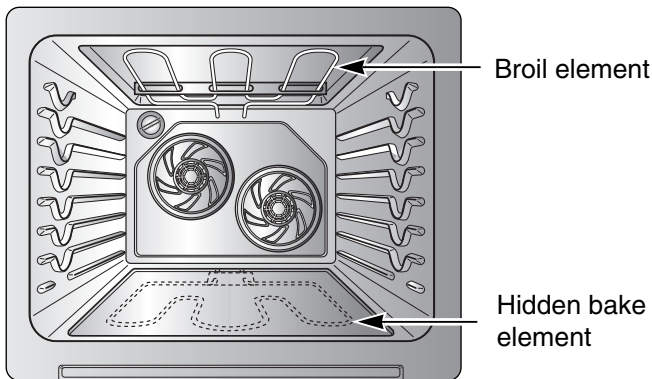

#### Convection Bake / Roast Mode

Upper element, lower element, Rear element (some model) and fan operate during convection bake. Convection bake should be used for cooking casseroles and roasting meats. Oven should be preheated for best results when using convection bake. Pans do not need to be staggered. Cooks approximately 25% quicker than bake.

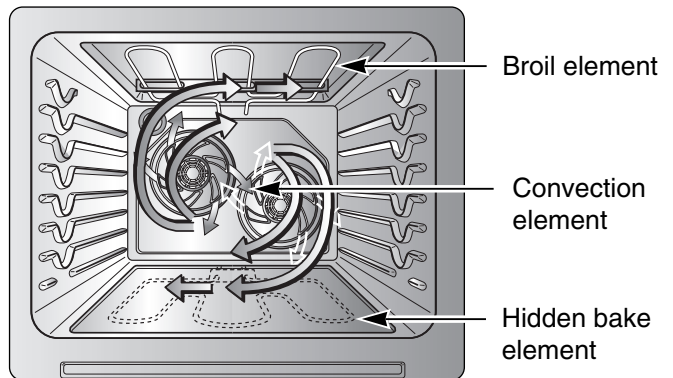

#### Cooking Guide

Refer to the owners manual for recommendations of times and temperatures. Times, rack position, and temperatures may vary depending on conditions and food type. For best results, always check food at minimum time. When roasting, choose rack position based on size of food item.

#### Broil Mode

Top element operates during broil. Broil can be used to cook foods which are normally broiled. Preheating is not required when using broil. All foods should be turned at least once except fish, which does not need to be turned.

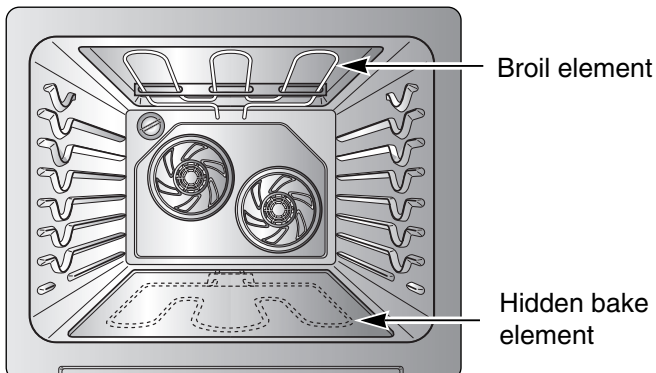

# USING YOUR RANGE

## CONTROL PANEL FEATURES

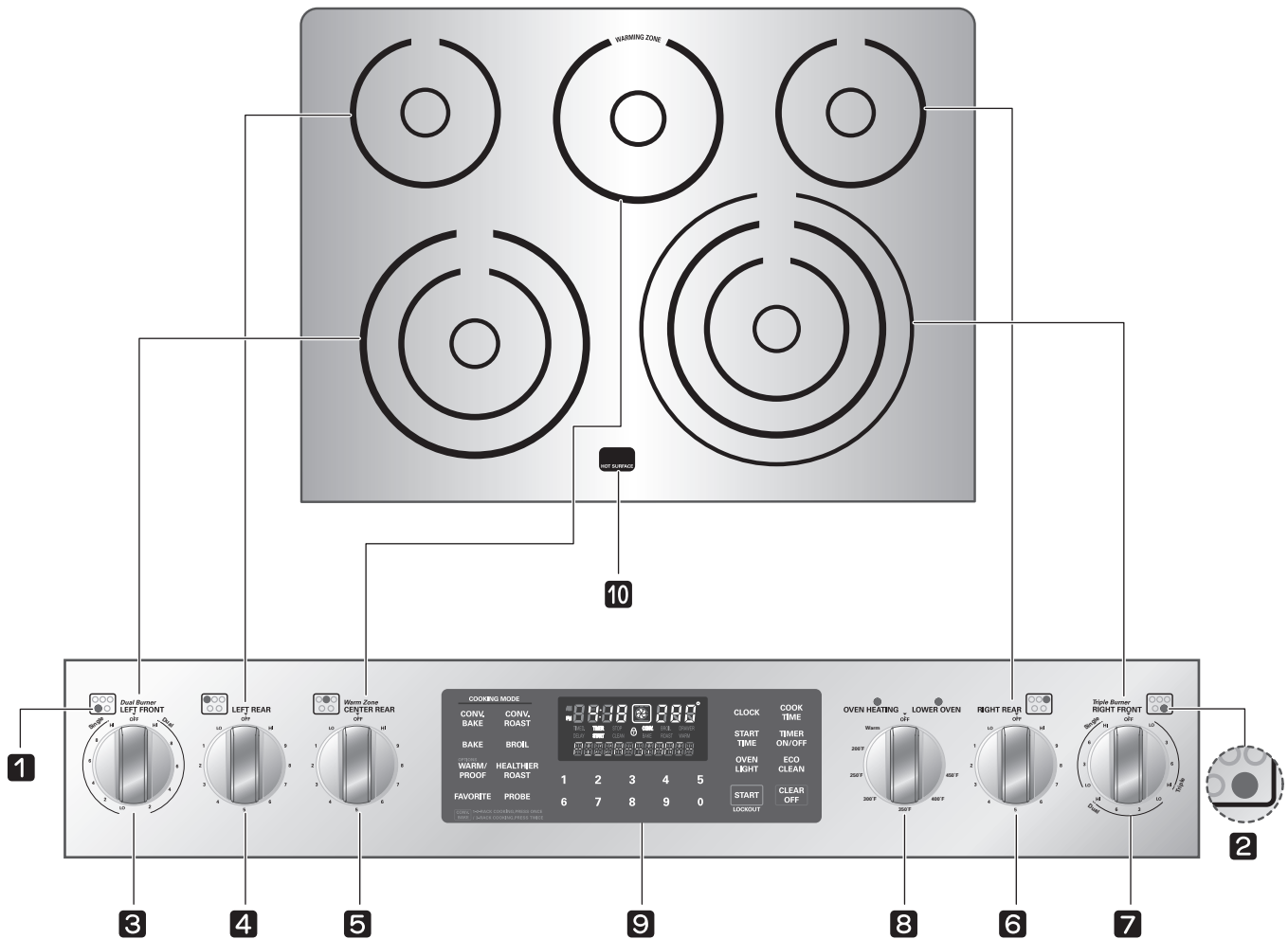

- 1 SURFACE COOKING AREA LOCATOR :** Identify which element the knob controls.
- 2 ELEMENT ON/OFF INDICATOR LIGHT :** Shows whether the surface element is turned on/off or hot.
- 3 LEFT FRONT (DUAL) CONTROL KNOB :** Use to control Left Front Element.
- 4 LEFT REAR (SINGEL) CONTROL KNOB :** Use to control Left Rear Element.
- 5 CENTER REAR (WARM) CONTROL KNOB :** Use to control Center Rear Element.

- 6 RIGHT REAR (SINGLE) CONTROL KNOB :** Use to control Right Rear Element.
- 7 RIGHT FRONT (TRIPLE) CONTRON KNOB :** Use to control Right Front Element.
- 8 LOWER OVEN CONTROL KNOB :** Use to control lower oven
- 9 ELECTRIC OVEN CONTROL :** Use to control Electric Oven.
- 10 HOT SURFACE INDICATOR LIGHT :** It will glow as long as any surface cooking area is too hot to touch.

# USING YOUR RANGE

Use to turn on the surface elements. An infinite choice of heat settings is available from LOW to HIGH. The knobs can be set on or between any of settings

**A To turn on a SINGLE surface unit : (Left Rear, Right Rear)**



- 1 Push the knob in.
- 2 Turn the knob in either direction to setting you want.  
The control knob clicks when it is positioned at both **OFF** and **HI**.

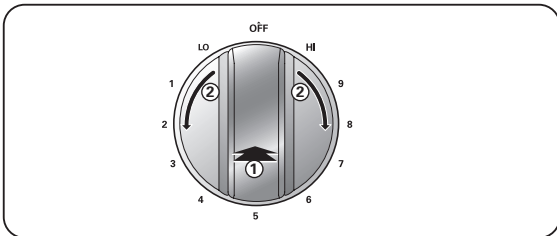

**B To turn on a DUAL surface unit : (Left Front)**



There is one dual element located in the left front position. This allows you to change the size of element.

- 1 Push the knob in.
- 2 —A Turn the knob counterclockwise to the **SINGLE** surface unit settings.
- 2 —B Turn the knob clockwise to the **DUAL** surface unit settings.

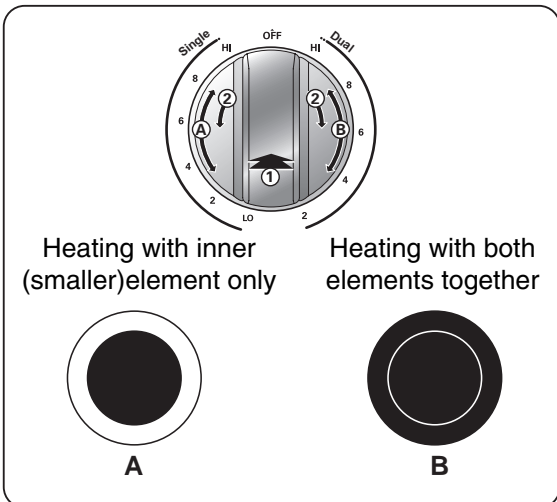

**C To turn on the Warming Zone : (Center Rear)**



There is the Warming Zone element located in the back center of the glass surface. It will keep hot cooked food at serving temperature.

- 1 Push the knob in.
- 2 Turn the knob in either direction to the setting you want.

**D To turn on a TRIPLE surface unit : (Right Front)**



There is one triple element located in the right front position. This allows you to change the size of element.

- 1 Push the knob in.
- 2 —A Turn the knob counterclockwise to the **SINGLE** surface unit settings.
- 2 —B Turn the knob clockwise or counterclockwise to the **DUAL** surface unit settings.
- 2 —C Turn the knob clockwise to the **TRIPLE** surface unit settings.

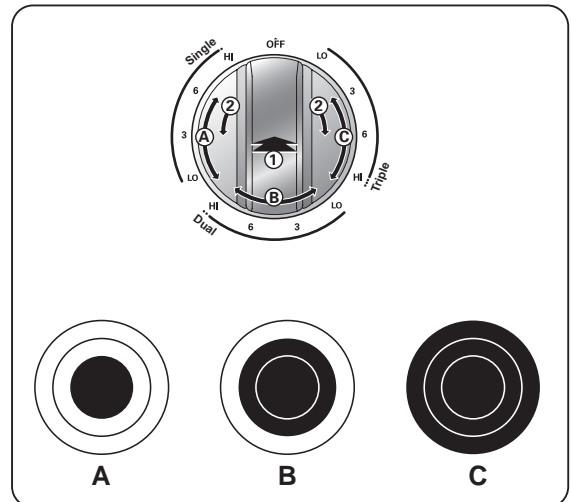



# USING YOUR RANGE

## 1. SETTING THE CLOCK

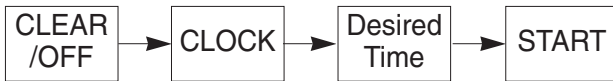

## 2. START, CLEAR/OFF AND ON/OFF PAD

1. Touch **START** pad to start oven.
2. Touch **CLEAR/OFF** pad to cancel a program during cooking or Erase during programming.
3. Touch **ON/OFF** pad to start or cancel the surface unit.

## 3. TO TURN ON/OFF THE OVEN LIGHT

The oven light automatically turns ON when the door is opened. The oven light may also be manually turned ON or OFF by pressing the **OVEN LIGHT** pad

**NOTE:** The oven light cannot be turned on if self-clean feature is active.

## 4. TIMER ON/OFF



To cancel timer at any time, touch **TIMER ON/OFF** pad.

### NOTE:

1. If you press **TIMER ON/OFF** pad once, this allows you to select "seconds"  
(for example: if you press "5" and "6", it means 56 seconds)
2. If you press **TIMER ON/OFF** pad twice, this allows you to select "minutes"  
(for example: if you press "5" and "6", it means 56 minutes)

## 5. SPECIAL FUNCTION: 6 types of category

### 1) CONVECTION AUTO CONVERSION

1. Touch and hold the **WARM/PROOF** pad for 3 seconds
2. Touch "1" pad for ENABLE  
or "2" pad for DISABLE
3. Touch **START** pad.

### 2) THERMOSTAT ADJUSTMENT

The oven temperature can be adjusted from -35°F (-19°C) to 35°F (19°C).

**NOTE:** The temperature adjustments made with this feature will just change Bake, Convection Bake and Convection Roast temperature.

### To increase the oven temperature:

1. Touch and hold the **WARM/PROOF** pad for 3 seconds.
2. Touch the **WARM/PROOF** pad 1 time
3. Touch the desired temperature
4. Touch **START** pad.

### To decrease the oven temperature:

1. Touch and hold the **WARM/PROOF** pad for 3 seconds
2. Touch the **WARM/PROOF** pad 1 time
3. Touch the **desired temperature**
4. Touch the **WARM/PROOF** pad once
5. Touch **START** pad

### 3) LANGUAGE SELECTION(English or French)

1. Touch and hold the **WARM/PROOF** pad for 3 seconds
2. Touch the **WARM/PROOF** pad 2 time
3. Touch "1" pad for ENGLISH  
or "2" pad for SPANISH  
or "3" pad for FRENCH
4. Touch "START" pad

### 4) PREHEATING ALARM LIGHT ON/OFF

1. Touch and hold the **WARM/PROOF** pad for 3 seconds
2. Touch the **WARM/PROOF** pad 3 time
3. Touch "1" pad for ON  
or "2" pad for OFF
4. Touch **START** pad

# USING YOUR RANGE

## 5) BEEPER VOLUME

1. Touch and hold the **WARM/PROOF** pad for 3 seconds
2. Touch the **WARM/PROOF** pad 4 time
3. Touch "1" pad for loud level  
or "2" pad for normal level  
or "3" pad for low level  
or "4" pad for mute level
4. Touch **START** pad

## 6) TEMPERATURE UNIT (°F or °C)

1. Touch and hold the **WARM/PROOF** pad for 3 seconds
2. Touch the **WARM/PROOF** pad 5 time
3. Touch or "1" pad for °F  
or "2" pad for °C
4. Touch **START** pad

## 6. BAKE, TIMED BAKE, DELAYED TIMED BAKE

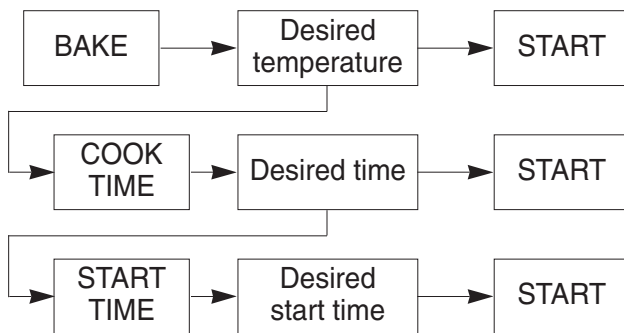

## 7. BROIL

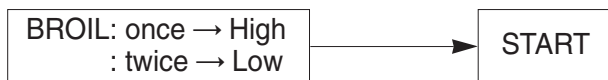

## 8. CONVECTION BAKE



## 9. CONVECTION ROAST



## 10. FAVORITES

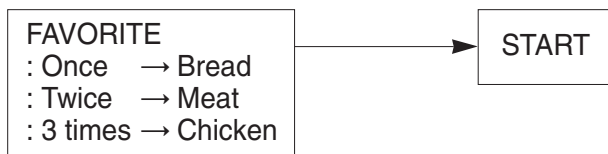

## 11. HEALTHIER ROAST

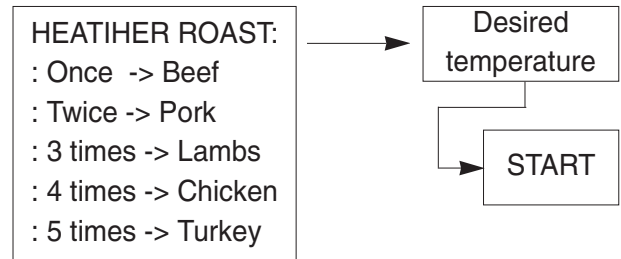

## 12. WARM/PROOF

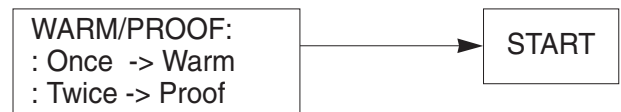

## 13. OVEN LOCKOUT

Press and hold the **START** pad for 3 seconds (to activate or reactivate LOCKOUT)

## 14. CHANGING HOUR MODE ON CLOCK (12HR, 24HR)

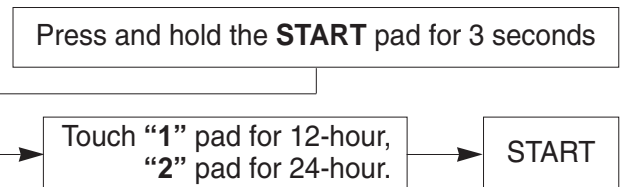

## 15. SELF-CLEAN

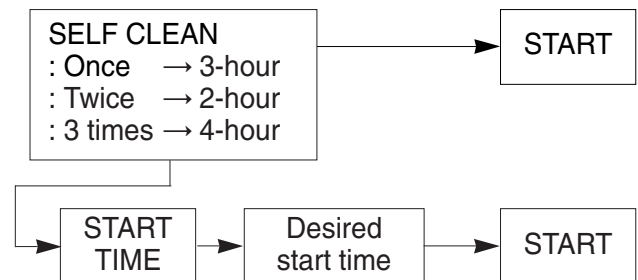

# USING YOUR RANGE

## LOWER OVEN DRAWER

### To Operate the Lower oven Drawer

The purpose of the Lower Oven is to bake foods using the same cooking times and temperatures you would in a standard oven. Foods ideal for baking in the lower oven drawer include pizza, frozen foods, casseroles, biscuit, rolls and many desserts.

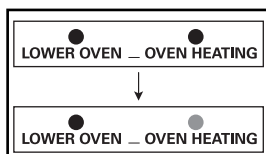
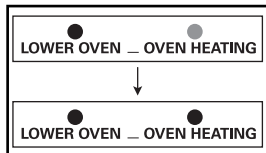
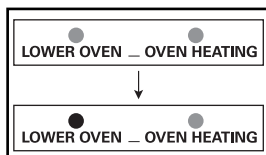
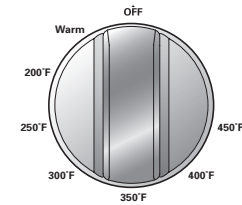

1. Push the knob in.
2. Turn the knob to any desired setting between Warm to **450°F**
3. When the knob is in the on position, the **“LOWER OVEN”** indicator light will glow. It remains ON until the knob is moved to the OFF position.
4. The **“OVEN HEATING”** indicator light glows when heating elements in the drawer are active. Food can continue to cook when the indicator light is on.
5. Preheat is complete after the **“OVEN HEATING”** signal has turned off.

- NOTE:**
- The Lower Oven does not shut off automatically.
  - The maximum food height that can be placed in the Lower Oven is 4 inches.
  - When turning the knob to use WARM function, check the “OVEN HEATING” signal is ON.
  - Opening the door may cause heat loss. Repeatedly opening may result in poor cooking results.

### CAUTION

- **Always use Pot Holders or oven mitts when removing food from the Lower Oven Drawer**
  - You can be burned as cookware and plates will be hot.
  - Do not put liquid or water in the Lower oven.
  - Never place plastics, paper, canned foods or combustible material in the Lower Oven.
  - Should a drawer fire occur, leave the drawer closed and turn the drawer off. If the fire continues, throw baking soda on the fire or use a fire extinguisher.
  - DO NOT put water or flour on the fire.
  - Flour may be explosive and water can cause a grease fire to spread and cause personal injury.

# COMPONENT ACCESS

This section instructs you on how to service each component inside the range. The components and their locations are shown below.

## COMPONENT LOCATIONS

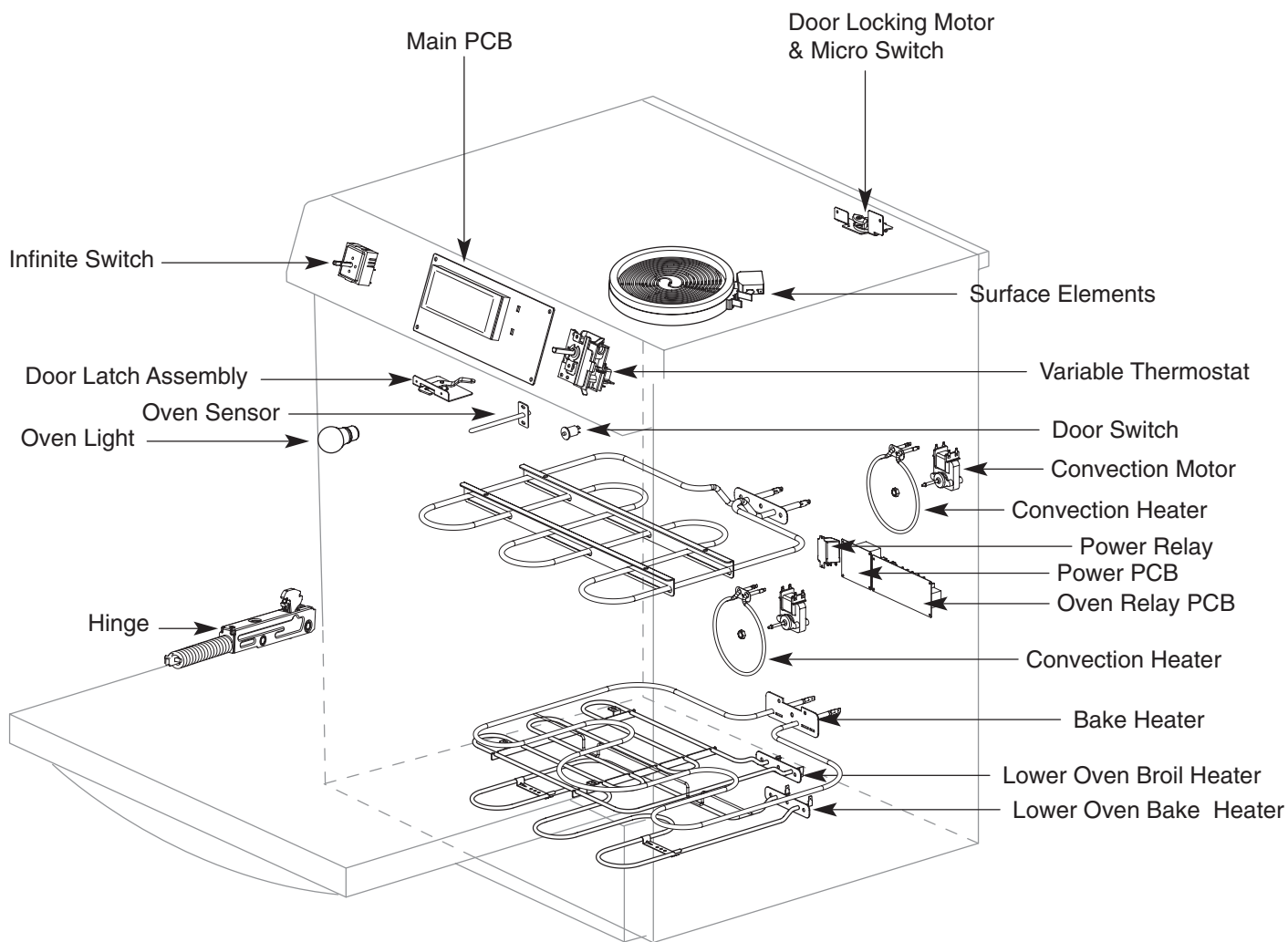

# COMPONENT ACCESS

## REMOVING THE BACK COVER

### **WARNING**

- **DISCONNECT** power supply cord from the outlet before servicing.
- **Replace all panels and parts before operating.**
- **RECONNECT** all grounding devices.
  - Failure to do so can result in severe personal injury, death or electrical shock.

### **CAUTION**

- **Be careful when you work on the electric range handling the sheet metal part.**
  - Sharp edge may be present and you can cut yourself.

1. Turn off the electrical supply going to the range.
2. Pull the range away from the wall so that you can access the rear panel.
3. To remove the back cover, remove 16 screws from the back cover



# COMPONENT ACCESS

## REMOVING THE OVEN RELAY PCB, POWER PCB, POWER RELAY AND SURGE FILTER

### ⚠ WARNING

- **DISCONNECT** power supply cord from the outlet before servicing.
- **Replace** all panels and parts before operating.
- **RECONNECT** all grounding devices.
  - Failure to do so can result in severe personal injury, death or electrical shock.

### ⚠ CAUTION

- **Be careful** when you work on the electric range handling the sheet metal part.
  - Sharp edge may be present and you can cut yourself.

1. Turn off the electrical supply going to the range.
2. Pull the range away from the wall so that you can access the rear panel.
3. Remove back cover (See step 3 on page 3-2)

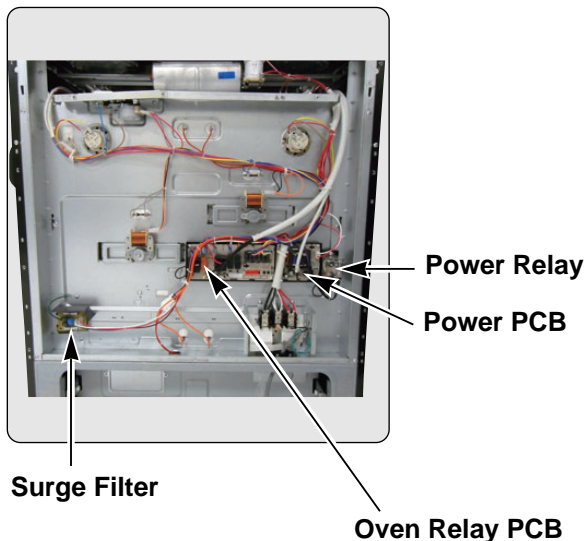

4. To remove the Oven Relay PCB, remove the 4 screws and disconnect 13ea connectors.

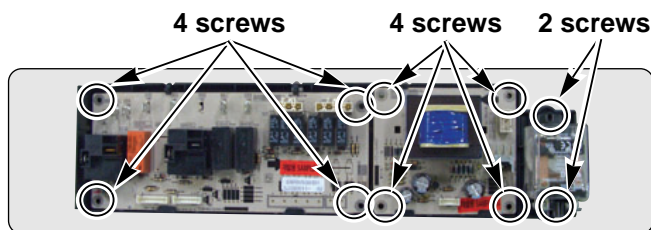
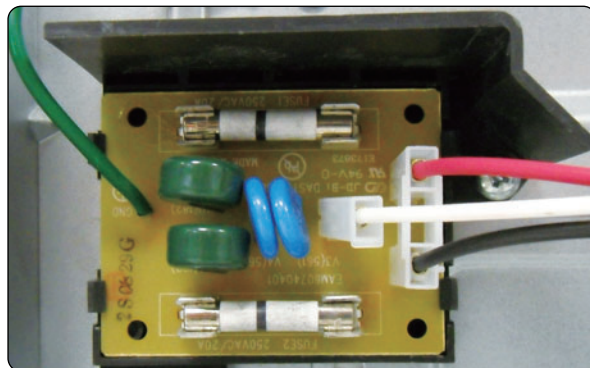

5. To remove the Power PCB, remove the 4 screws and disconnect the connectors.

6. To remove the Power Relay, remove the 2 screws and disconnect the connectors.

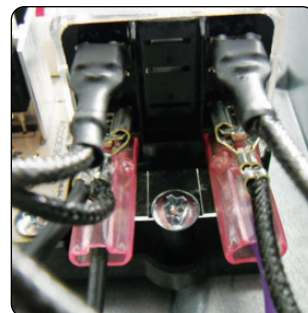

7. To remove the Surge Filter, remove the 2 screw located on the back plate and disconnect the connectors

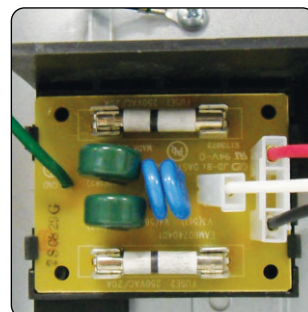



# COMPONENT ACCESS

## REMOVING THE CONTROLLER

### **⚠ WARNING**

- **DISCONNECT** power supply cord from the outlet before servicing.
- **Replace** all panels and parts before operating.
- **RECONNECT** all grounding devices.
  - Failure to do so can result in severe personal injury, death or electrical shock.

### **⚠ CAUTION**

- **Be careful** when you work on the electric range handling the sheet metal part.
  - Sharp edge may be present and you can cut yourself.

1. Turn off the electrical supply going to the range.
2. Open the oven door.
3. Remove the 2 screws located at the front side of the cooktop.



4. Remove the 4 screws located under the controller.



5. Pull the controller from the range

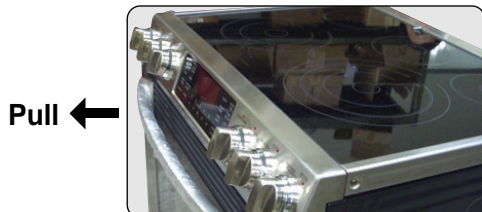

6. To remove the controller

- a) Pull out the knob of Lower Oven and remove the 2 screws of Knob Housing
- b) Remove the 2 screws on the controller

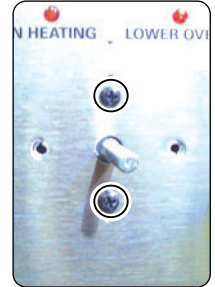
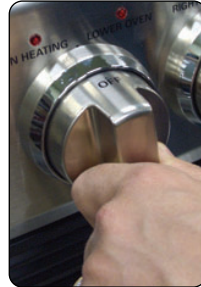

- c) Unplug the connector of Variable Thermostat and remove it from the controller

Connector

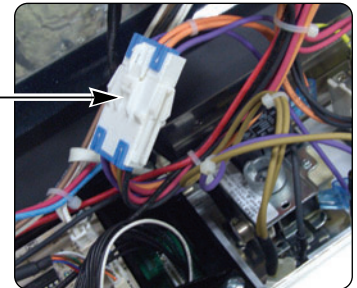

- d) You can remove the controller after unplug the connectors of Main PCB and Cooktop.

**REASSEMBLY NOTE :** When you reinstall the controller make sure that the cooktop gasket is fixed into the cooktop correctly.

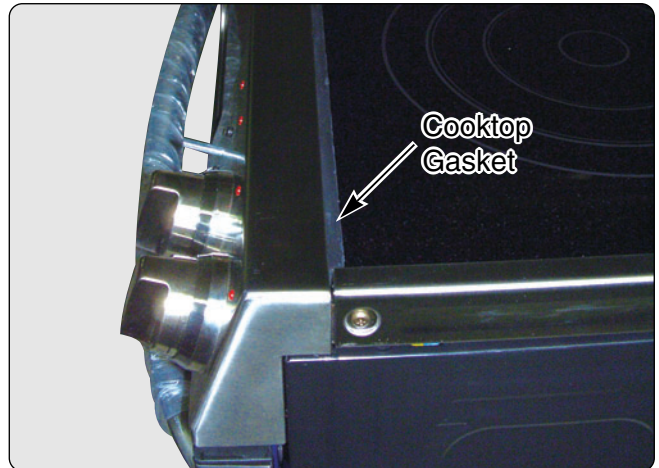

# COMPONENT ACCESS

## REMOVING THE MAIN PCB AND KEY PCB ASSEMBLY

### **⚠ WARNING**

- **DISCONNECT** power supply cord from the outlet before servicing.
- **Replace** all panels and parts before operating.
- **RECONNECT** all grounding devices.
  - Failure to do so can result in severe personal injury, death or electrical shock.

### **⚠ CAUTION**

- **Be careful** when you work on the electric range handling the sheet metal part.
  - Sharp edge may be present and you can cut yourself.

1. Turn off the electrical supply going to the range.
2. Pull the controller from the range. (See page 3-4)
3. To remove the Main PCB, remove the 4 screws of Main PCB and separate Main PCB after unplugging the connectors.



4. To remove the Key PCB assembly
  - a) Remove the 2 screws under the controller



2 Screws

- b) Grip the Main PCB supporter and pull it out from the controller strongly with opening the inlet of controller using another hand.

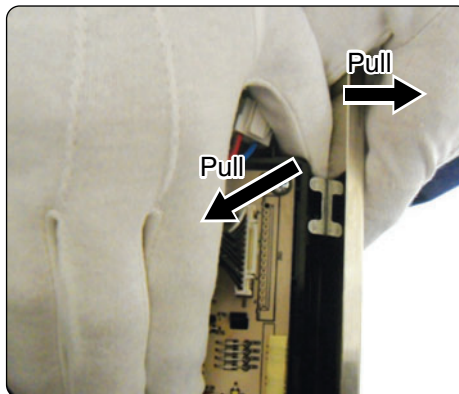

- c) Remove the 4 screws of the Main PCB supporter.

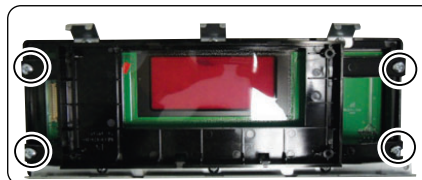

- d) For servicing the KEY PCB Assembly, the brackets of assembly should be separated

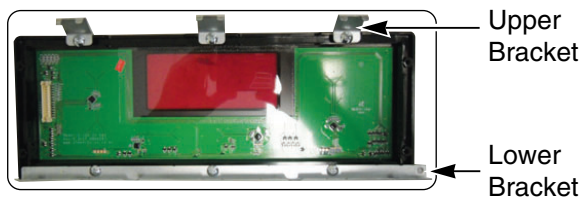

**REASSEMBLY NOTE :** When you reinstall the Key PCB Assembly make sure that the upper brackets of it are inserted into the correct guide then reinstall the lower bracket screw.



# COMPONENT ACCESS

## REMOVING KNOB AND INFINITE SWITCH

### ⚠ WARNING

- **DISCONNECT** power supply cord from the outlet before servicing.
- **Replace** all panels and parts before operating.
- **RECONNECT** all grounding devices.
  - Failure to do so can result in severe personal injury, death or electrical shock.

### ⚠ CAUTION

- **Be careful** when you work on the electric range handling the sheet metal part.
  - Sharp edge may be present and you can cut yourself.

1. Turn off the electrical supply going to the range.
2. Pull the controller from the range. (See page 3-4)
3. There are 5 Infinite switches. When you check Infinite switches, firstly check the electric test each other. (refer to the page ~~)
4. To remove the Infinite switch (ex. RF switch)
  - a) Disconnect the all wire to fault Infinite switch
  - b) Pull out a knob from the Infinite switch shaft.

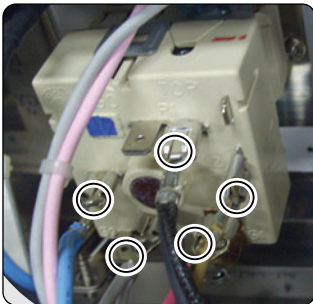

c) Remove the 2 screw of Knob Housing

d) Remove the 2 screw on the controller

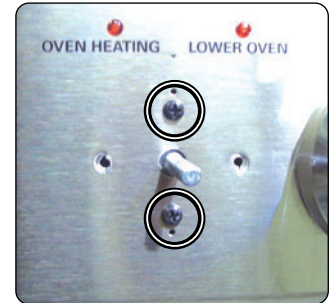

e) After replacing the infinite switch, finally check the electric and wiring.

		Position	Wire color
<b>LR/RR Switch</b>		1 - H1	OR-OR
		2 - P	-
		3 - L1	RD+RD
		4 - H2	YL
		5 - L2	BK-BK
<b>LF Switch</b>		P1	BK+BK
		P2	RD+RD
		2	BN
		4	BL+BL
		4a	VI
		S1/S2	-
<b>RF Switch</b>		P1	BK+BK
		P2	RD+RD
		2	BN
		4	BL+BL
		4a	GY+GY
		J4	GY
		4b	PK
		S1/S2	-
<b>CR Switch</b>		P1	BK+BK
		P2	RD
		2	PK
		4	GY+GY
		Pilot	-

# COMPONENT ACCESS

## REMOVING THE CERAMIC GLASS COOKTOP, THE SURFACE ELEMENT AND THE HOT SURFACE LAMP

### **⚠ WARNING**

- **DISCONNECT** power supply cord from the outlet before servicing.
- **Replace** all panels and parts before operating.
- **RECONNECT** all grounding devices.
  - Failure to do so can result in severe personal injury, death or electrical shock.

### **⚠ CAUTION**

- **Be careful** when you work on the electric range handling the sheet metal part.
  - Sharp edge may be present and you can cut yourself.

1. Turn off the electrical supply going to the range.
2. Pull the range away from the wall so that you can access the rear panel.
3. Pull the controller from the range. (See page 3-4)
4. To remove the ceramic glass cooktop
  - a) Remove 2 screws in front of cooktop.

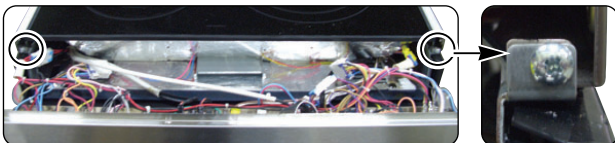

- b) Remove 3 screws on the back cover from the cooktop



- c) Remove 2 connectors which connect controller harness with cooktop harness.

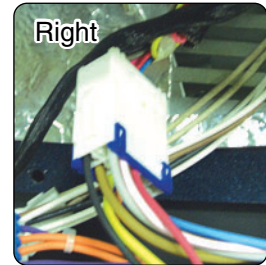
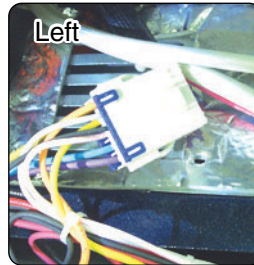

- d) Protect the cooktop surface and turn the assembly over.

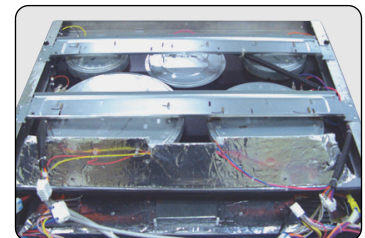

5. To remove the surface elements
  - a) Remove the wires from the element and limiter terminals.
  - b) Remove the element bracket screw (shown above) for the element you are servicing.
  - c) Carefully lift the bottom of the bracket just far enough to remove the element.
6. To remove the Hot surface lamp
  - a) Remove the wires from the lamp.
  - b) Push the side of lamp and lift it up, then you can remove the lamp.

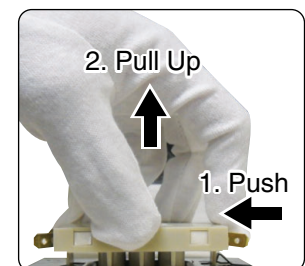
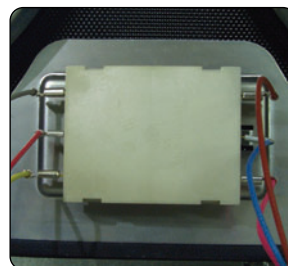

**REASSEMBLY NOTE:** When you reinstall the element or lamp make sure that the wires are inserted into the correct tap then reinstall the bracket screw to secure it to the cooktop.

# COMPONENT ACCESS

## REMOVING THE CERAMIC GLASS COOKTOP, THE SURFACE ELEMENT AND THE HOT SURFACE LAMP

### **⚠ WARNING**

- **DISCONNECT** power supply cord from the outlet before servicing.
- **Replace** all panels and parts before operating.
- **RECONNECT** all grounding devices.
  - Failure to do so can result in severe personal injury, death or electrical shock.

### **⚠ CAUTION**

- **Be careful** when you work on the electric range handling the sheet metal part.
  - Sharp edge may be present and you can cut yourself.

1. Turn off the electrical supply going to the range.
2. Pull the range away from the wall so that you can access the rear panel.
3. Open the oven door.
4. Pull the controller from the range. (See page 3-4)
5. Remove the cooktop (See 3-7)
6. To remove the door latch:
  - a) Remove the two screws from the door latch

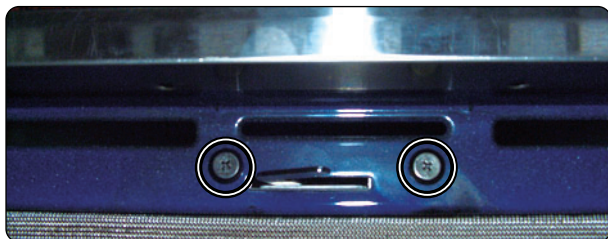

- b) Remove the 4 screws on the top ceramic wool
- c) Remove the 2 screws on the both side brackets, and remove the side brackets

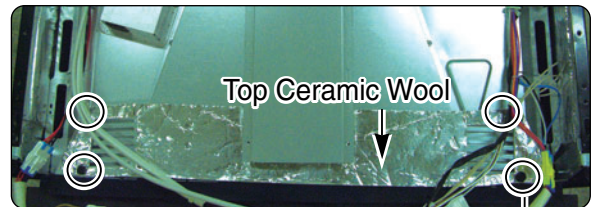

- d) To remove the main duct, remove the 11 screws on the main duct

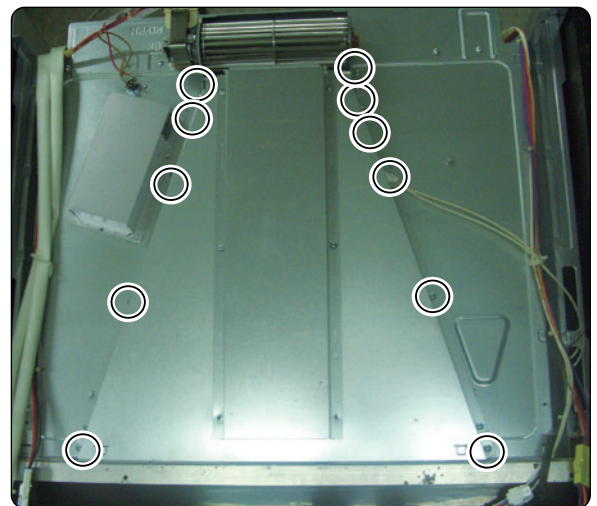



# COMPONENT ACCESS

- e) Remove the door latch from the burner box and unhook the actuating rod.

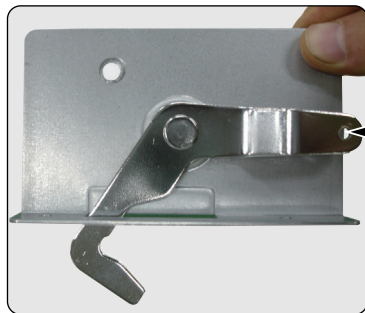

Unhook Actuating Rod

7. To remove the cooling motor  
a) Remove the wires from the motor

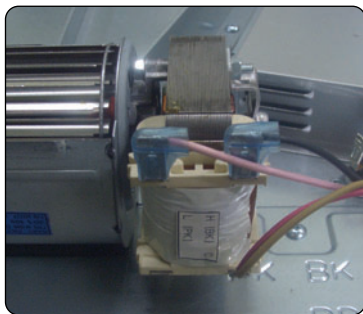

- b) Remove 4 screws on the Main duct from the cooling Motor

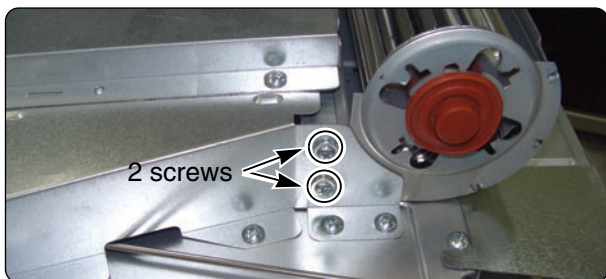

8. To remove the thermal disk, remove the 1 screw and remove the 2 wires.

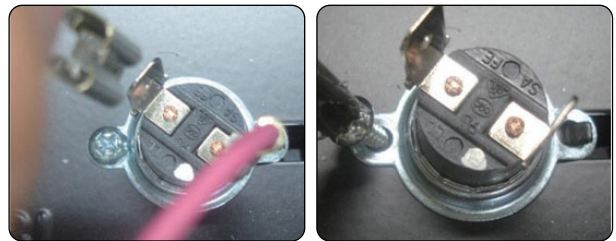

The thermostat is located on the cavity cover . It opens at 356°F/180°C and closes when the oven temperature cools below 14°F/-10°C.

9. To remove the door switch  
a) Remove the door switch from the range. To do this, squeeze tabs and use a ratchet extension or a small socket, and tap it out of the hole with a hammer.

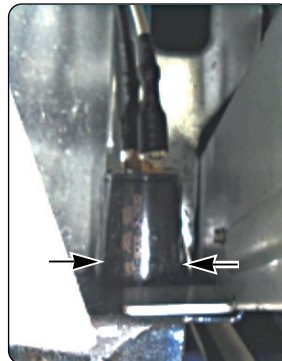

- b) Disconnect the wires from the terminal



# COMPONENT ACCESS

## REMOVING THE BROIL ELEMENT

### **WARNING**

- **DISCONNECT** power supply cord from the outlet before servicing.
- **Replace** all panels and parts before operating.
- **RECONNECT** all grounding devices.
  - Failure to do so can result in severe personal injury, death or electrical shock.

### **CAUTION**

- **Be careful** when you work on the electric range handling the sheet metal part.
  - Sharp edge may be present and you can cut yourself.

- b) Pull the element forward so that you can access the terminals and disconnect the wires.

2 Terminals

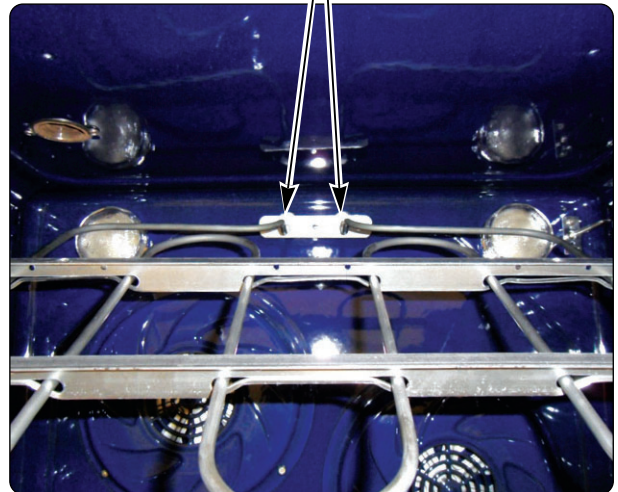

1. Turn off the electrical supply going to the range.
2. Open the oven door and remove the racks from inside the oven.
3. **To remove the broil element:**
  - a) Remove the 6 screws from the front and rear brackets.

4 Upper bracket Screws

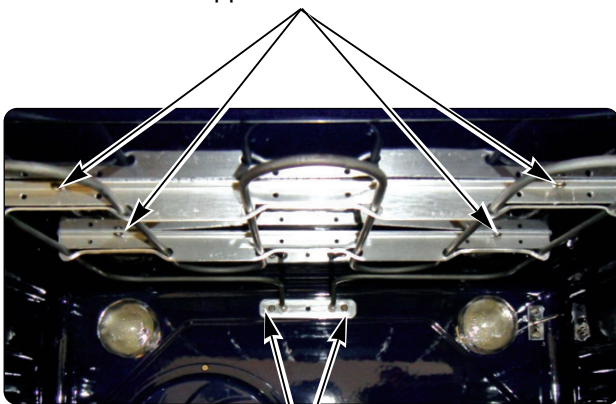

2 Rear bracket Screws

# COMPONENT ACCESS

## REMOVING THE HIDDEN BAKE ELEMENT

1. Unplug range or disconnect power.
2. Pull the range out of its mounting location so that you can access the rear of the unit.
3. Remove the rear panel from the unit.  
(See step 3 on page 3-2 for procedure)

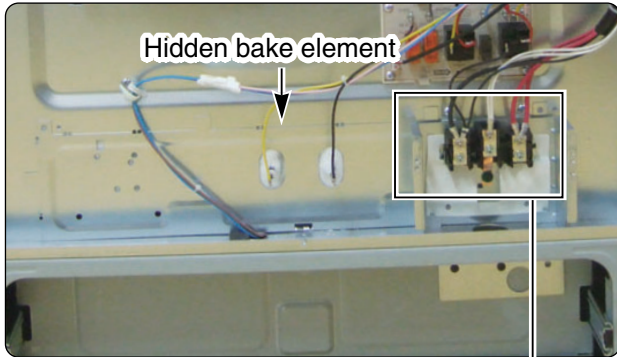

4. Remove the 2 screws of power cord assembly box and 1 ground screw.
5. Set the box aside

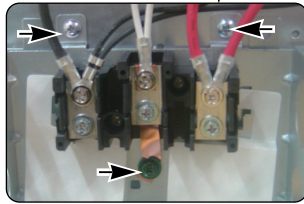

6. Cut the 9 points of flange and remove the bake heater cover.

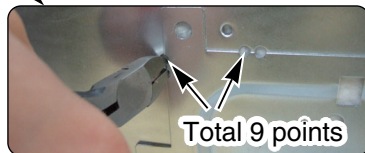
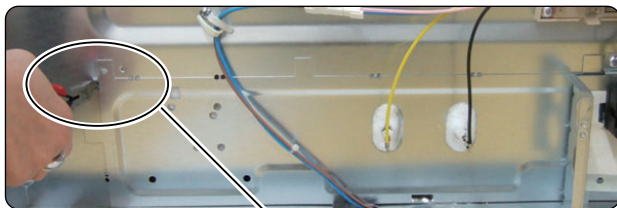

7. Bend the insulation glass fiber up.

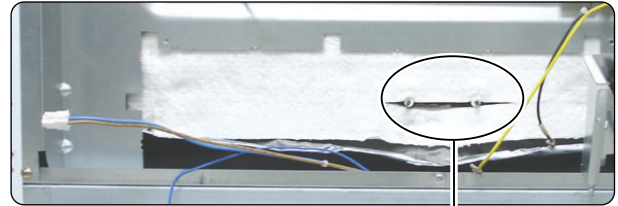

8. Remove two screws and bend up two flanges

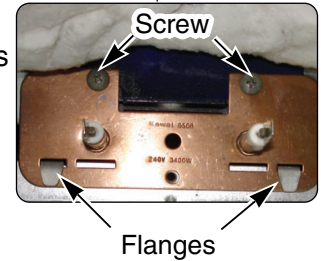

9. Carefully pull the hidden bake element and its mounting bracket out of the range.

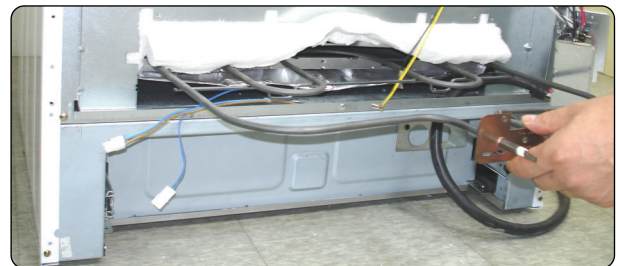

## REPLACING THE MOUNTING BRACKET



1. Drive the two screws



# COMPONENT ACCESS

## REMOVING THE CONVECTION ELEMENT, FAN BLADE AND FAN MOTOR

1. Disconnect power and remove oven racks.
2. Pull the range out of its mounting location so that you can access the rear of the unit.
3. Remove the rear panel from the unit.  
(See step 3 on page 3-2 for procedure)
4. Disconnect the wire connection.

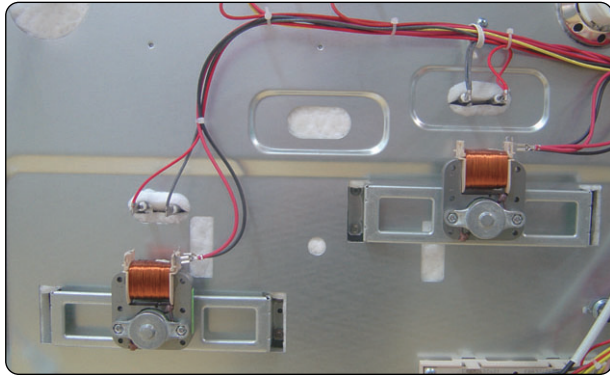

5. Remove the four Fan cover screws and set the fan cover aside.

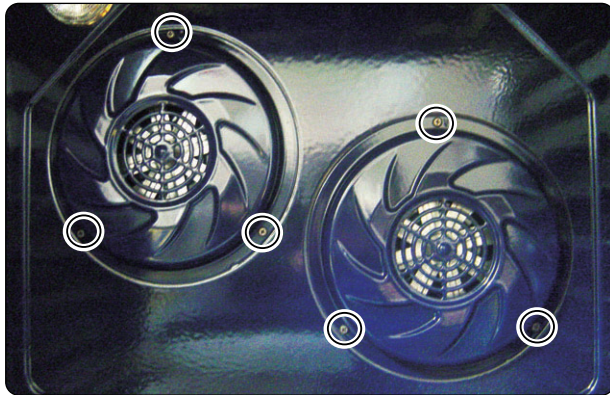

6. Remove the two convection element screws and pull the element forward.

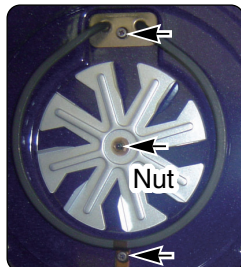

7. To remove Fan blade, remove Nut by screwing clockwise. Fan blade can be replaced from inside oven.

### CAUTION

- **Be careful not to bend the fan blade**  
- Failure to do so can result in vibration, noise, and poor performance of convection when operating.

8. To remove Fan motor assembly, disconnect wire connection and remove the three bracket screws

9. Pull the fan motor assembly forward.

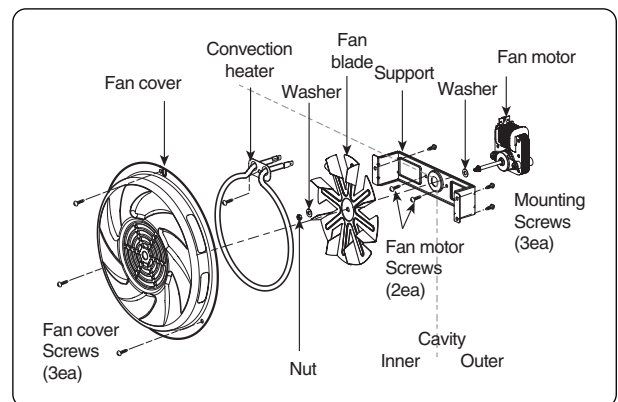
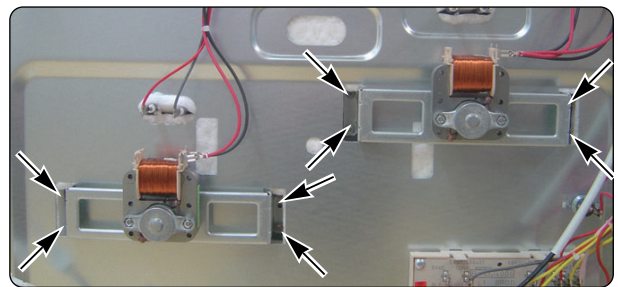

# COMPONENT ACCESS

## REMOVING THE OVEN LIGHT & SOCKET ASSEMBLY

### ⚠ WARNING

- **DISCONNECT** power supply cord from the outlet before servicing.
- **Replace all panels and parts before operating.**
- **RECONNECT** all grounding devices.
  - Failure to do so can result in severe personal injury, death or electrical shock.

### ⚠ CAUTION

- **Be careful when you work on the electric range handling the sheet metal part.**
  - Sharp edge may be present and you can cut yourself.

#### To replace:

1. Unplug range or disconnect power.
2. Turn the glass bulb cover in the back of the oven counterclockwise to remove.
3. Turn bulb counterclockwise to remove from socket.
4. Replace bulb and bulb cover by turning clockwise.

Glass cover & Bulb

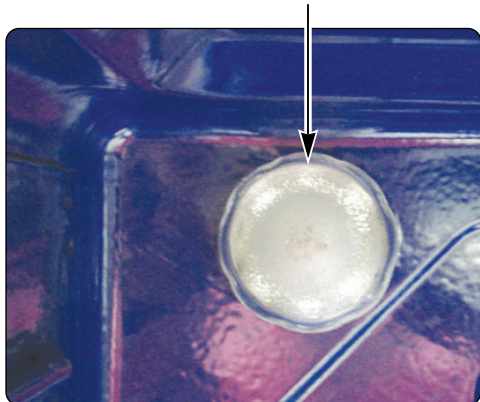

### ⚠ CAUTION

- **Be careful not to scratch or chip the oven liner paint when you remove the oven light socket in the next step.**

5. Use a screwdriver and bend the clips on the oven light socket away from the edges of the liner hole, and pull the socket out of the liner.

NOTE: If it is too difficult to remove the socket from the front of the oven, you will have to push the socket out from the back of the unit.

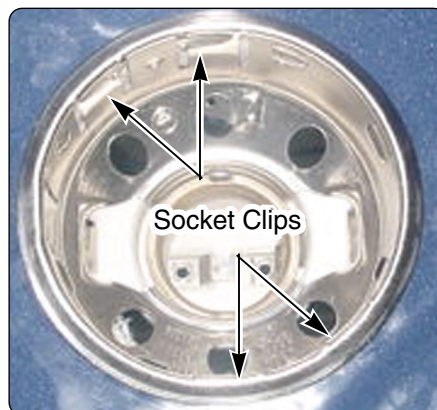

5. Disconnect the wires from the socket terminals.

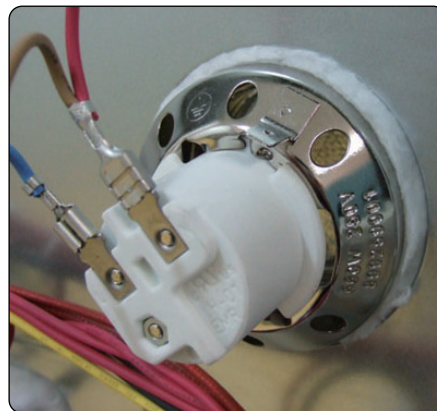

<Viewed From Rear Panel>



# COMPONENT ACCESS

## REMOVING THE LATCH DRIVE ASSEMBLY

### ⚠ WARNING

- **DISCONNECT** power supply cord from the outlet before servicing.
- **Replace all panels and parts before operating.**
- **RECONNECT** all grounding devices.
  - Failure to do so can result in severe personal injury, death or electrical shock.

### ⚠ CAUTION

- **Be careful when you work on the electric range handling the sheet metal part.**
  - Sharp edge may be present and you can cut yourself.

1. Turn off the electrical supply going to the range.
2. Pull the range away from the wall so that you can access the rear panel.
3. Remove the back cover & control cover (see step 3 on page 3-2).
4. Disconnect the wires from the latch drive motor and switch.
5. Remove the two mounting screws from the latch drive.



6. Unhook the Latch rod from the cam.

### DOOR LOCKING MECHANISM

The door lock assembly is located at the back side of range.

The structural elements are as below.

1. When the oven control is programmed and started for the Self clean and Lock out mode, PCB (Power control board) chip operates the motor.

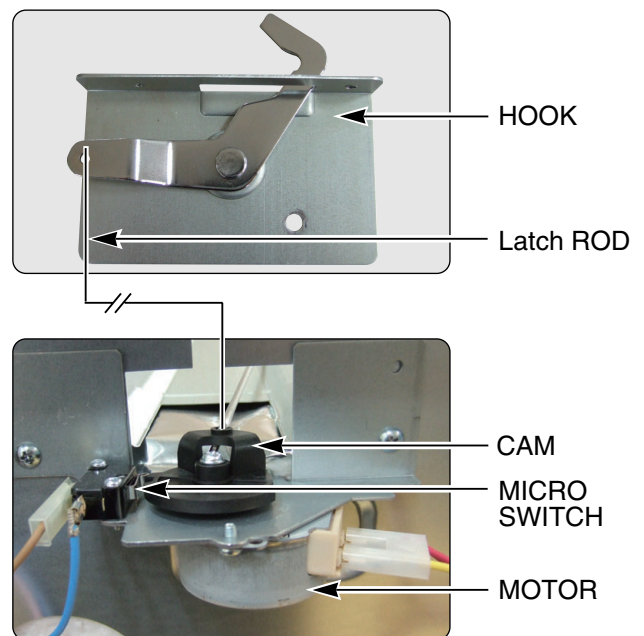

2. The cam moves the door hook connected to latch rod from unlocked position to locked position (from locked Position to unlocked position)
3. The cam activates the micro switch that causes the motor to stop.
4. The locked status remains until the range temperature drops to approximately 500F after end of the self clean or lock out feature is reactivated. The motor operates to unlock door at that time.

# COMPONENT ACCESS

## REMOVING THE OVEN TEMPERATURE SENSORS

### **⚠ WARNING**

- **DISCONNECT** power supply cord from the outlet before servicing.
- **Replace all panels and parts before operating.**
- **RECONNECT** all grounding devices.
  - Failure to do so can result in severe personal injury, death or electrical shock.

### **⚠ CAUTION**

- **Be careful when you work on the electric range handling the sheet metal part.**
  - Sharp edge may be present and you can cut yourself.

1. Turn off the electrical supply going to the range.
2. Open the oven door and remove the racks from the oven.
3. Pull the range away from the wall so that you can access the rear panel.
4. Remove the 16 screws from the rear panel and remove the panel (see step 3 on page 3-2).

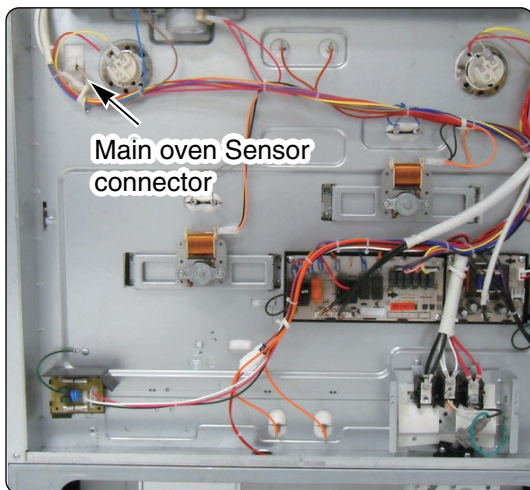

5. To remove an oven temperature sensor, disconnect the connector from the main harness and remove the two mounting screws in oven cavity.

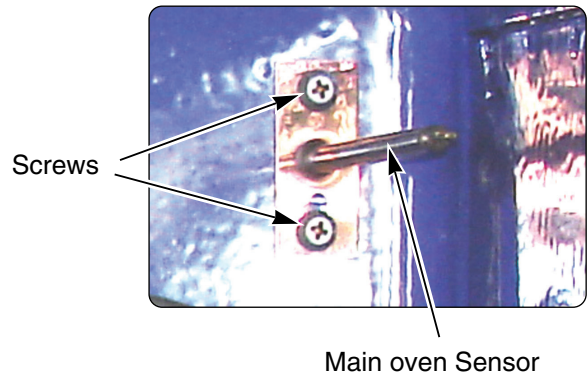

# COMPONENT ACCESS

## REMOVING & REPLACING THE LIFT-OFF OVEN DOOR

### **CAUTION**

- Be careful when removing and lifting the door.
- DO NOT lift the door by the handle.
  - Failure to do so can result in personal injury as the door is very heavy.

To remove the door:

#### Step. 1

Fully open the door.

#### Step. 2

Pull the hinge locks down toward (Fig.1) the door frame, to the unlocked position.

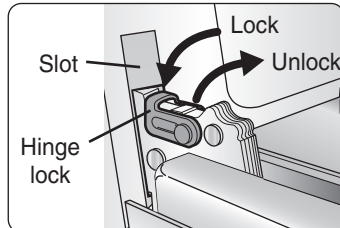

<Fig.1>

#### Step. 3

Firmly grasp both sides of the door at the top.

#### Step. 4

Close door to the door removal position, which is approximately 5 degrees. (refer to the Fig.2)

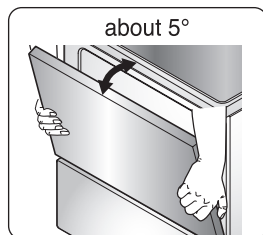

<Fig.2>

#### Step. 5

Lift door up and out until the hinge arm is clear of the slot.

To replace the door:

#### Step. 1

Firmly grasp both sides of the door at the top.

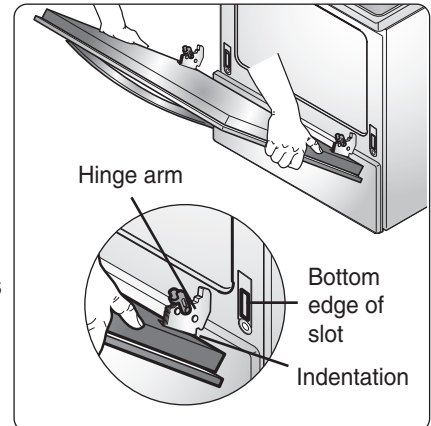

#### Step. 2

With the door at the same angle as the removal position, seat the indentation of the hinge arm into the bottom edge of the hinge slot. The notch in the hinge arm must be fully seated into the bottom of the slot.

#### Step. 3

Fully open the door. If the door will not fully open, the indentation is not seated correctly in the bottom edge of the slot.

#### Step. 4

Push the hinge locks up against the front frame of the oven cavity to the locked position.

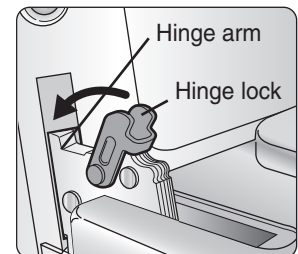

#### Step. 5

Close the oven door.

# COMPONENT ACCESS

## REMOVING A SIDE PANEL

### **⚠ WARNING**

- **DISCONNECT** power supply cord from the outlet before servicing.
- **Replace all panels and parts before operating.**
- **RECONNECT** all grounding devices.
  - Failure to do so can result in severe personal injury, death or electrical shock.

### **⚠ CAUTION**

- **Be careful when you work on the electric range handling the sheet metal part.**
  - Sharp edge may be present and you can cut yourself.

1. Turn off the electrical supply going to the range.
2. Remove the oven door from the range  
(see page 3-15)
3. Pull the range away from the wall.
4. Remove the back cover of the range  
(see page 3-2)
5. Pull the controller from the range.  
(see page 3-4)
6. Remove the cooktop (See page 3-7)
7. Remove the two screws from the left or right side panel.

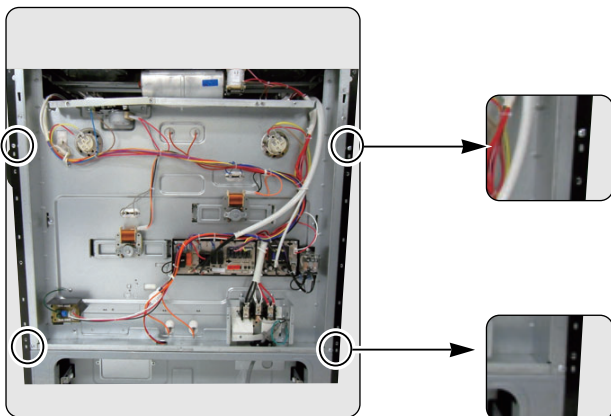

8. Pull the back of the side panel out from the range approximately 10°

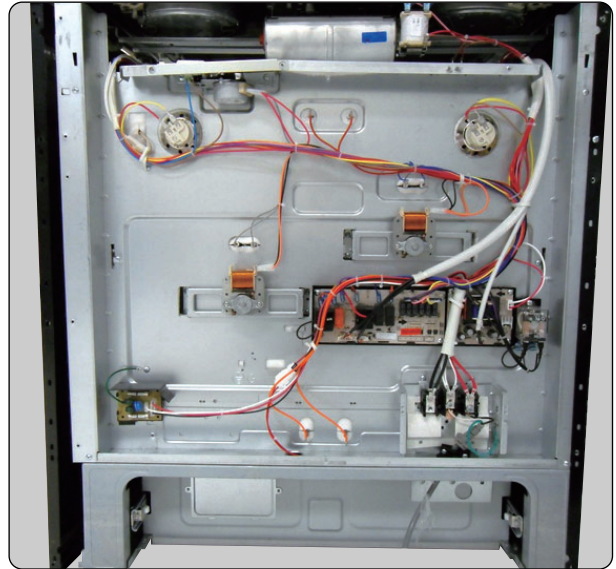

9. Push forward and remove the side panel.



# COMPONENT ACCESS

## REMOVING THE LOWER OVEN ELEMENT

### **⚠ WARNING**

- **DISCONNECT** power supply cord from the outlet before servicing.
- **Replace** all panels and parts before operating.
- **RECONNECT** all grounding devices.
  - Failure to do so can result in severe personal injury, death or electrical shock.

### **⚠ CAUTION**

- **Be careful** when you work on the electric range handling the sheet metal part.
  - Sharp edge may be present and you can cut yourself.

#### To Remove Lower oven Drawer :

### **⚠ CAUTION**

- **Turn power OFF** before removing the Lower oven Drawer :

1. Open the drawer to the fully opened position.
2. Remove the 2 screws (right and left side). (refer to below picture)

3. Locate glide lever on each side of drawer, push down on the left glide lever and pull up on the right glide lever.

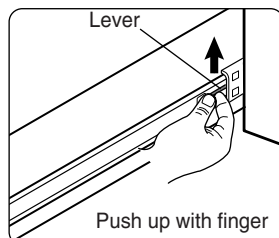
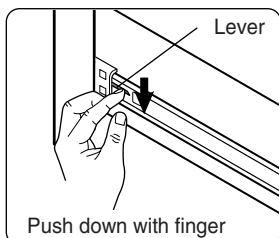
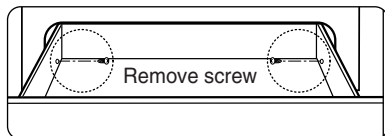

4. Pull the warming drawer away from the range.

#### To Remove Lower oven Broil Element :

1. Pull the range away from the wall.
2. Remove the 3 screws from the upper bracket and 2 screws from the rear bracket

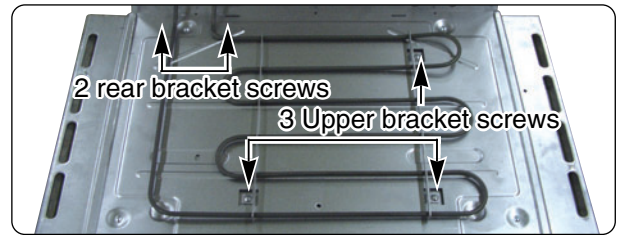

4. Remove 2 screws of the lower oven element cover and disconnect wires from the terminal.

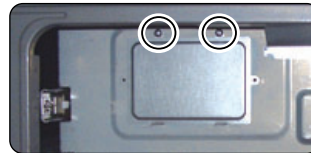

#### To Remove Lower oven Broil Element :

1. Pull the range away from the wall.
2. Remove the 5 screws from the bottom and rear bracket.

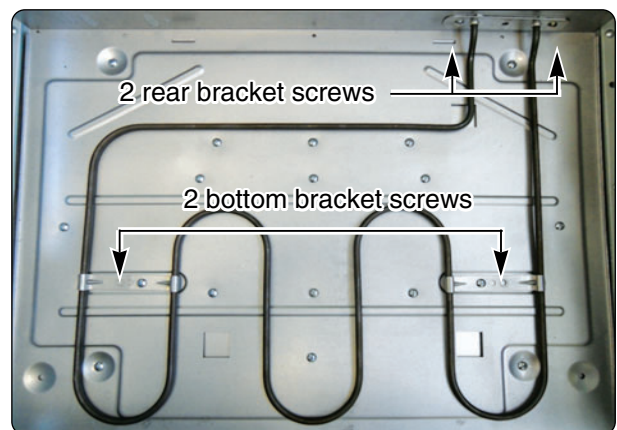

3. Remove 2 screws of the lower oven element cover and disconnect wires from the terminal.

# SAFETY

## REMOVING THE VARIABLE THERMOSTAT

### WARNING

- **DISCONNECT** power supply cord from the outlet before servicing.
- **Replace all panels and parts before operating.**
- **RECONNECT** all grounding devices.
  - Failure to do so can result in severe personal injury, death or electrical shock.

### CAUTION

- **Be careful when you work on the electric range handling the sheet metal part.**
  - Sharp edge may be present and you can cut yourself.

1. Turn off the electrical supply going to the range.
2. Pull the range away from the wall.
3. Pull the controller from the range.  
(See page 3-4)
4. Remove the variable thermostat from the controller.
5. Remove the right side panel from the range, (See page 3-17) and you can see the sensor bracket of variable thermostat.

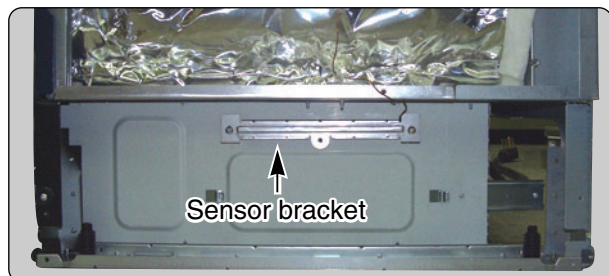

5. Remove 2 screws of the sensor bracket



6. Remove the sensor of variable thermostat from the sensor bracket.

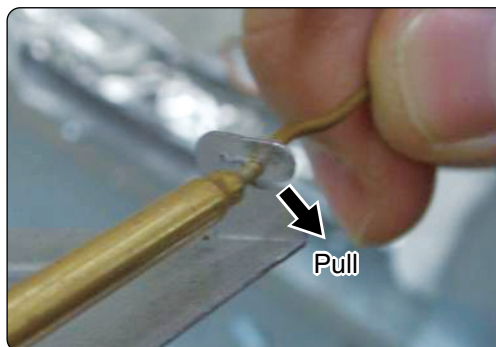

7. Disconnect all wire from variable thermostat.

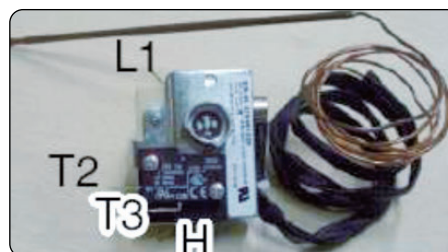

Position	Wire color
L1/H	VI
T2/T3	OR

8. After replacing the variable thermostat, finally check the electric test and wiring.

# COMPONENT ACCESS

## REMOVING THE OVEN DOOR HANDLE & GLASS

### ⚠ WARNING

- **DISCONNECT** power supply cord from the outlet before servicing.
- **Replace all panels and parts before operating.**
- **RECONNECT** all grounding devices.
  - Failure to do so can result in severe personal injury, death or electrical shock.

### ⚠ CAUTION

- **Be careful when you work on the electric range handling the sheet metal part.**
  - Sharp edge may be present and you can cut yourself.

5. Lift the liner assembly off the front glass and set it aside.
6. **To remove the door handle & trim** (for stainless model)
  - a) Remove the 4 door handle screws and lift the door handle off door trim and slide up the door handle.

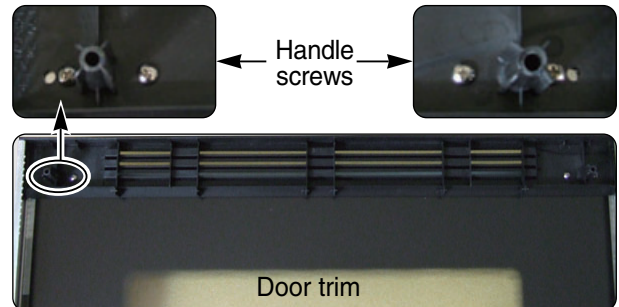

1. Remove the oven door from the range (see page 3-16 for the procedure).
2. Place the oven door on a padded work surface with the front glass facing down.
3. Remove the 4 top door screws.



4. Remove the three bottom screws from the door liner.

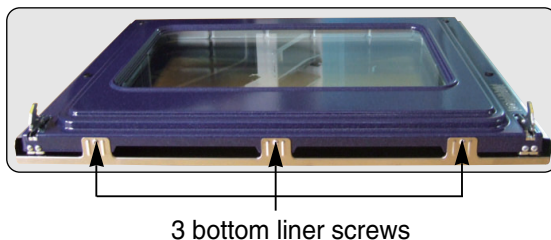

# COMPONENT ACCESS

## 7. To remove a hinge hanger assembly:

- Remove the 2 top liner screws  
(See step 3 on page 3-14)
- Place the door liner assembly on a padded work surface with the hinge hangers over the edge.
- Remove the two bottom screws.
- Lift the hinge hanger out of the door liner slot.

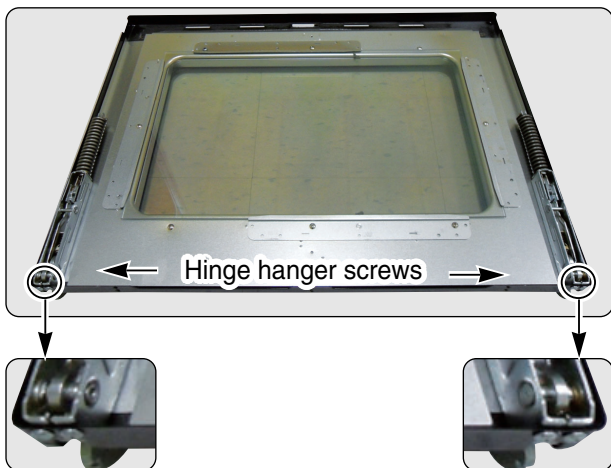

- Lift the inner oven door glass and bracket assembly out of the door liner.

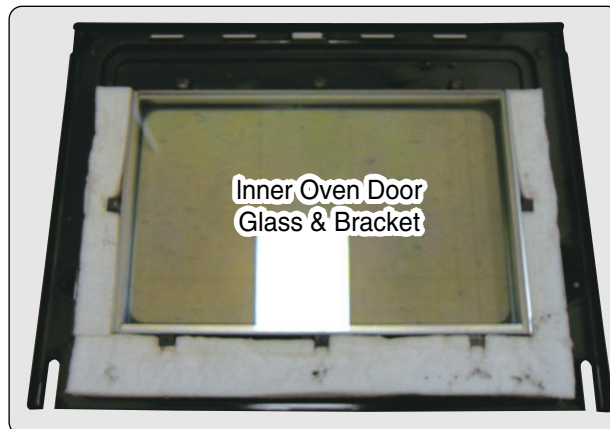

**REASSEMBLY NOTE:** When you reinstall the insulation around the oven door glass, make sure that the insulation is not visible in the glass after the door is reassembled.

## 8. To remove the oven door glass assembly:

- Remove both hinge hangers (see step 7).
- Remove the 6 screws from the outer glass brackets.
- Lift the outer glass and bracket out of the door liner.

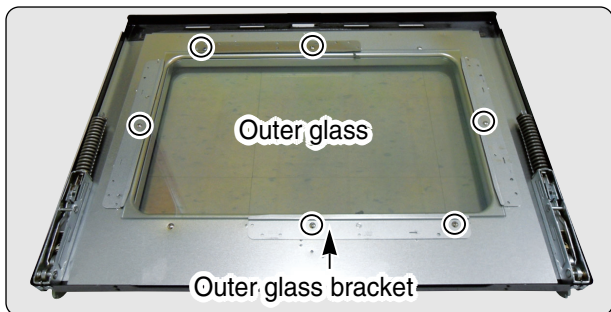

- Remove the 2 screws from the insulation cover
- Lift the insulation cover out of the door liner.

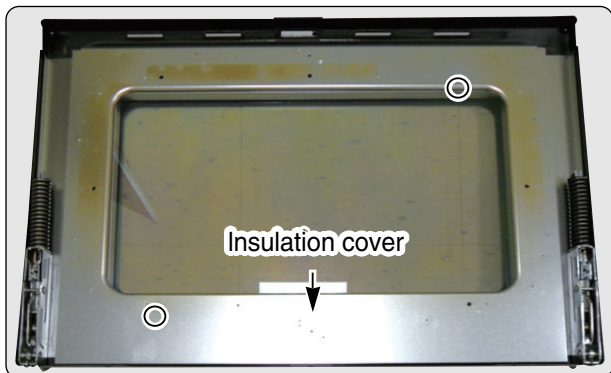



# COMPONENT ACCESS

## REMOVING THE OVEN DOOR GASKET

### **⚠ WARNING**

- **DISCONNECT** power supply cord from the outlet before servicing.
- **Replace all panels and parts before operating.**
- **RECONNECT** all grounding devices.
  - Failure to do so can result in severe personal injury, death or electrical shock.

### **⚠ CAUTION**

- **Be careful when you work on the electric range handling the sheet metal part.**
  - Sharp edge may be present and you can cut yourself.

3. Pull the ends of the gasket out of the liner holes.

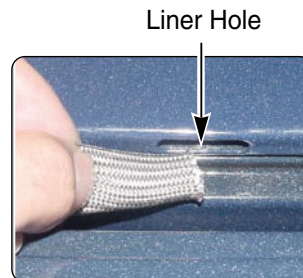

**REASSEMBLY NOTE:** When you install the new gasket, make sure that all of the clips are seated in their liner holes, and that the ends of the gasket are pushed fully into their holes. Use the pointed end of a pencil to push the gasket ends into the holes.

1. Open the oven door to its fully down position.
2. Pull the oven door gasket clips out of the liner holes until all of the clips are removed.

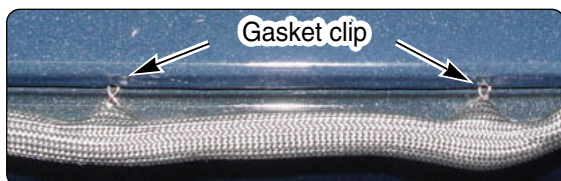
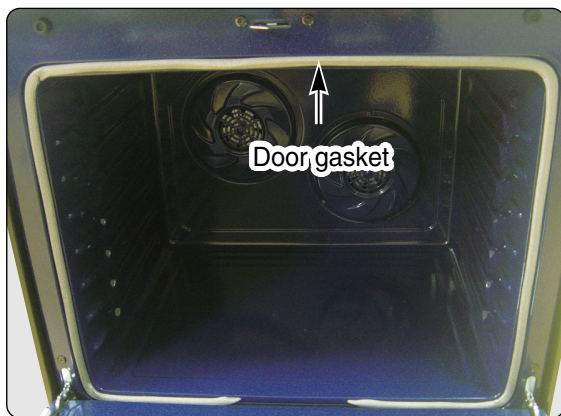

# COMPONENT TEST

Before testing any of components, perform the following checks:

**NOTE:**

1. The most common cause for control failure is corrosion on connectors.  
Therefore, disconnecting and reconnecting wires will be necessary throughout test procedures
2. ALL units in the first few days of use should be checked for mis-wiring or loose connections



1. All/tests/checks should be made with a VOM or DVM having a sensitivity of 20,000 ohms per-volt DC, or greater.
2. Check all connections before replacing components, looking for broken or loose wires, Failed terminals, or wires not pressed into connectors far enough.
3. Resistance checks must be made with power cord unplugged from outlet, and with wiring harness or connectors disconnected.



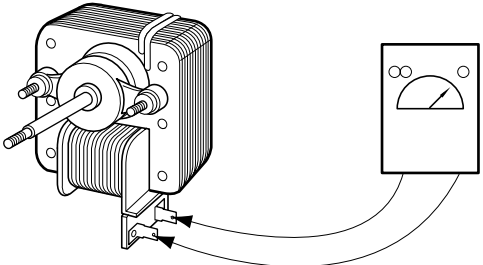

**! WARNING**

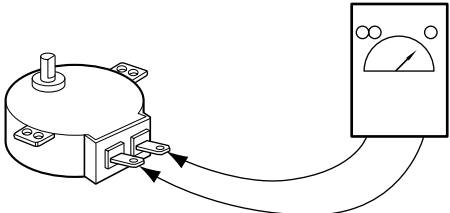
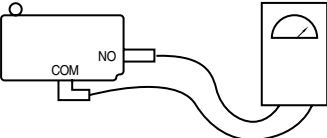
- Disconnect power supply cord from the outlet before servicing
- Replace all panels and parts before operating
- Reconnect all grounding devices after servicing
- Failure to do so can result in death or electrical shock

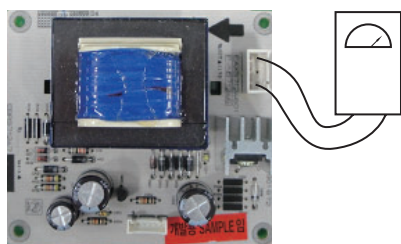
**NOTE: Below  $\Omega$  value were tested at room temperature (77F/25°C)**

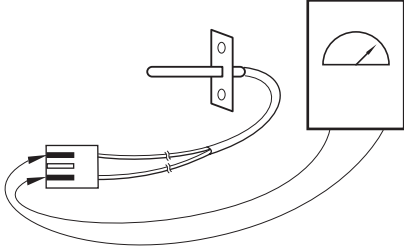
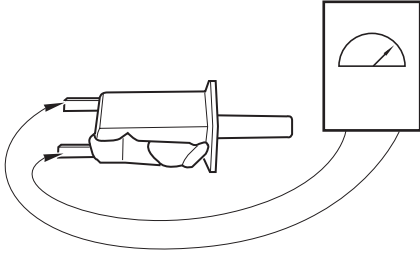
Components	Test procedures	Results
<p>Convection Motor</p>	<ol style="list-style-type: none"> <li>1. Refer to page 3-12 for the servicing procedure</li> <li>2. Measure the resistance (Multiple meter scale: R x 1)</li> </ol> 	<p>Normal: Approximately <math>33.5 \Omega \pm 10\%</math> If not replace</p> <p>Abnormal: Infinite (open) below <math>5\Omega</math> (shorted)</p>

Components	Test procedures	Results	
Door locking Motor	1. Refer to page 3-14 for the servicing procedure 2. Measure the resistance (Multiple meter scale: R x 1000)  	Normal: Approximately $2.6\text{ k}\Omega \pm 10\%$ If not replace Abnormal: Infinite(open) below $5\Omega$ (shorted)	
Micro Switch (normally open type)	1. Refer to page 3-14 for the servicing procedure 2. Measure the resistance (Multiple meter scale: R x 1000)  	Door latch open	Door latch Locked
		 Continuity	 Infinite
<b>NOTE:</b> After checking for the continuity of switch, make sure that they are connected correctly			
LVT	1. Refer to page 3-3 for the servicing procedure 2. Measure the resistance (Multiple meter scale: R x 1000)  	Normal: Approximately $27\ \Omega \pm 10\%$ If not replace	

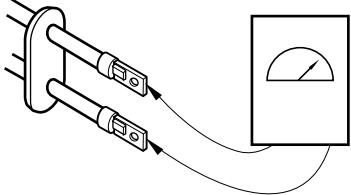
Components	Test procedures	Results	
<p>Oven Sensor</p>	<p>1. Refer to page 3-15 for the servicing procedure  2. Measure the resistance after cooling down  (Multiple meter scale: R x 1000)</p> 	<p>Normal: Approximately  1.09 kΩ ± 10%  If not replace</p> <p><b>NOTE:</b> Ω Value was tested at room temperature (77F/25°C)</p>	
<p>NOTE: Oven sensor is so sensitive to temperature  Do test after cooling down sufficiently</p>			
<p>Door switch</p>	<p>1. Refer to page 3-9 for the servicing procedure  2. Measure the resistance after cooling down  (Multiple meter scale: R x 1000)</p> 	<p>Door open</p>	<p>Door closed</p>
		 Continuity	 Infinite
<p>Broil heater</p> 	<p>1. Refer to page 3-10 for the servicing procedure  2. Measure the resistance after cooling down  (Multiple meter scale : R x 1)</p> 	<p>Normal: Approximately  14 Ω ± 10%  If not replace</p> <p><b>NOTE:</b> Ω Value was tested at room temperature (77F/25°C)  Be careful the element is sensitive to temperature.</p>	

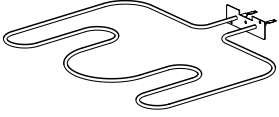
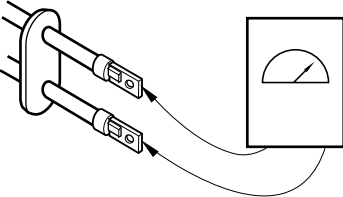
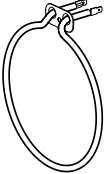
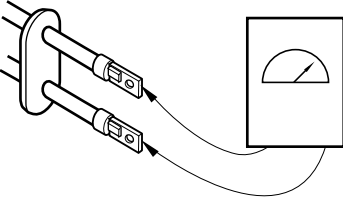
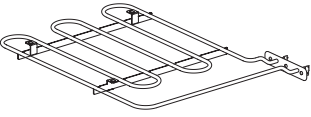
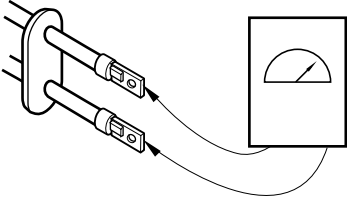
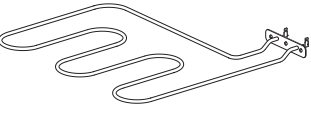
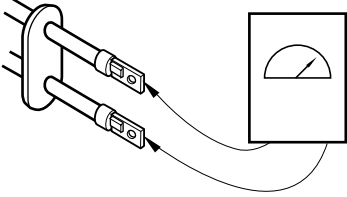

Components	Test procedures	Results
<p>Bake heater</p> 	<p>1. Refer to page 3-11 for the servicing procedure 2. Measure the resistance after cooling down (Multiple meter scale : R x 1)</p> 	<p>Normal: Approximately <math>17 \Omega \pm 10\%</math> If not replace</p> <p><b>NOTE:</b> <math>\Omega</math> Value was tested at room temperature (77F/25°C) Be careful the element is sensitive to temperature.</p>
<p>Convection heater</p> 	<p>1. Refer to page 3-12 for the servicing procedure 2. Measure the resistance after cooling down (Multiple meter scale : R x 1)</p> 	<p>Normal: Approximately <math>80 \Omega \pm 10\%</math> If not replace</p> <p><b>NOTE:</b> <math>\Omega</math> Value was tested at room temperature (77F/25°C) Be careful the element is sensitive to temperature.</p>
<p>Drawer Upper heater</p> 	<p>1. Refer to page 3-18 for the servicing procedure 2. Measure the resistance after cooling down (Multiple meter scale: R x1)</p> 	<p>Normal : Approximately <math>144\Omega \pm 10\%</math> If not replace</p> <p><b>NOTE:</b> <math>\Omega</math> Value was tested at room temperature (77F/25°C) Be careful the element is sensitive to temperature.</p>
<p>Drawer Lower heater</p> 	<p>1. Refer to page 3-18 for the servicing procedure 2. Measure the resistance after cooling down (Multiple meter scale: R x1)</p> 	<p>Normal : Approximately <math>72\Omega \pm 10\%</math> If not replace</p> <p><b>NOTE:</b> <math>\Omega</math> Value was tested at room temperature (77F/25°C) Be careful the element is sensitive to temperature.</p>

<b>Components</b>	<b>Test procedures</b>	<b>Results</b>
Oven lamp	<p>1. Measure the resistance after cooling down (Multiple meter scale: R x1)</p> 	Normal: Below 5 $\Omega$ . If not replace

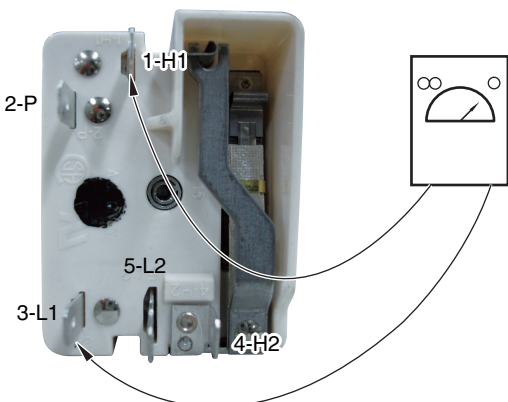
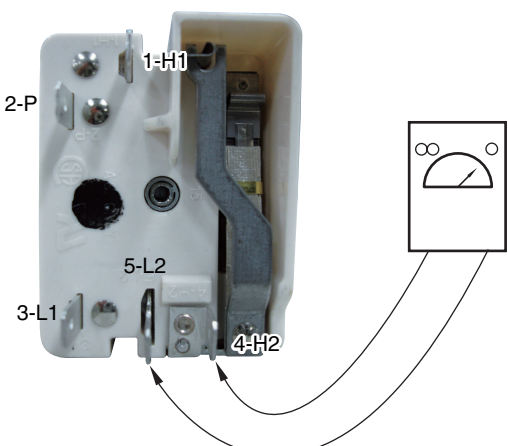
Components	Test procedures	Results																			
Infinite switch (Single units): LR switch RR switch	<ol style="list-style-type: none"> <li>1. Refer to page 3-6 for the servicing procedure.</li> <li>2. Set the Multiple meter scale to the R x 1000.</li> <li>3. Disconnect all wires from infinite switch.</li> <li>4. When turn on/turn off the knob, position measure the resistance between L1 to H1.</li> </ol>  <ol style="list-style-type: none"> <li>5. When turn on/turn off the knob, position measure the resistance between L2 to H2.</li> </ol> 																				
	<table border="1"> <thead> <tr> <th data-bbox="467 1640 495 1683"></th> <th data-bbox="495 1640 654 1683">Infinite Switch</th> <th data-bbox="654 1640 834 1683">Knob Position</th> <th colspan="2" data-bbox="834 1640 1273 1683">Results</th> </tr> </thead> <tbody> <tr> <td data-bbox="467 1683 495 1757" rowspan="2">Single type</td> <td data-bbox="495 1683 654 1757" rowspan="2">LR</td> <td data-bbox="654 1683 834 1757" rowspan="2">Off</td> <td data-bbox="834 1683 987 1715">L1 - H1</td> <td data-bbox="987 1683 1273 1715">Infinite(open circuit)</td> </tr> <tr> <td data-bbox="834 1715 987 1757">L2 - H2</td> <td data-bbox="987 1715 1273 1757">Infinite(open circuit)</td> </tr> <tr> <td data-bbox="467 1757 495 1832" rowspan="2">Single type</td> <td data-bbox="495 1757 654 1832" rowspan="2">RR</td> <td data-bbox="654 1757 834 1832" rowspan="2">On</td> <td data-bbox="834 1757 987 1789">L1 - H1</td> <td data-bbox="987 1757 1273 1789">Continuity(short circuit)</td> </tr> <tr> <td data-bbox="834 1789 987 1832">L2 - H2</td> <td data-bbox="987 1789 1273 1832">Continuity(short circuit)</td> </tr> </tbody> </table>		Infinite Switch	Knob Position	Results		Single type	LR	Off	L1 - H1	Infinite(open circuit)	L2 - H2	Infinite(open circuit)	Single type	RR	On	L1 - H1	Continuity(short circuit)	L2 - H2	Continuity(short circuit)	
	Infinite Switch	Knob Position	Results																		
Single type	LR	Off	L1 - H1	Infinite(open circuit)																	
			L2 - H2	Infinite(open circuit)																	
Single type	RR	On	L1 - H1	Continuity(short circuit)																	
			L2 - H2	Continuity(short circuit)																	

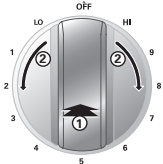
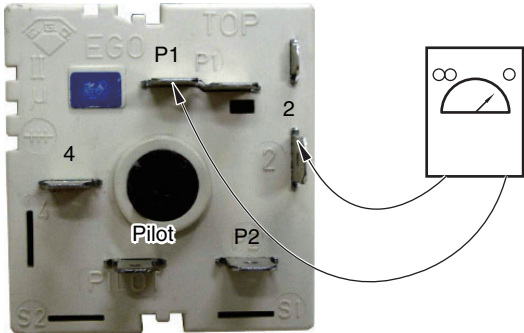
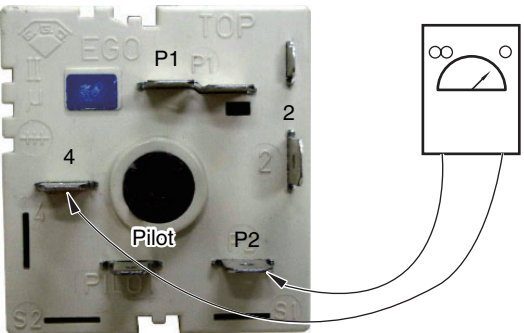
Components	Test procedures	Results																							
<p>Infinite switch (Single units): CR Switch</p> 	<ol style="list-style-type: none"> <li>1. Refer to page 3-6 for the servicing procedure.</li> <li>2. Set the Multiple meter scale to the R x 1000.</li> <li>3. Disconnect all wires from infinite switch.</li> <li>4. When turn on/turn off the knob, position measure the resistance between P1 to 2.</li> </ol>  <ol style="list-style-type: none"> <li>5. When turn on/turn off the knob, position measure the resistance between P2 to 4</li> </ol> 																								
	<table border="1"> <thead> <tr> <th data-bbox="347 1651 493 1683"></th> <th data-bbox="493 1651 651 1683">Infinite Switch</th> <th data-bbox="651 1651 833 1683">Knob Position</th> <th colspan="2" data-bbox="833 1651 1271 1683">Results</th> </tr> </thead> <tbody> <tr> <td data-bbox="347 1683 493 1757" rowspan="2">Single type</td> <td data-bbox="493 1683 651 1757" rowspan="2">CR</td> <td data-bbox="651 1683 833 1725">Off</td> <td data-bbox="833 1683 992 1715">P1 -2</td> <td data-bbox="992 1683 1271 1715">Infinite(open circuit)</td> </tr> <tr> <td data-bbox="651 1725 833 1757"></td> <td data-bbox="833 1725 992 1757">P2 -4</td> <td data-bbox="992 1725 1271 1757">Infinite(open circuit)</td> </tr> <tr> <td data-bbox="347 1757 493 1825"></td> <td data-bbox="493 1757 651 1825"></td> <td data-bbox="651 1757 833 1800">On</td> <td data-bbox="833 1757 992 1789">P1 -2</td> <td data-bbox="992 1757 1271 1789">Continuity(short circuit)</td> </tr> <tr> <td data-bbox="347 1800 493 1825"></td> <td data-bbox="493 1800 651 1825"></td> <td data-bbox="651 1800 833 1825"></td> <td data-bbox="833 1800 992 1825">P2 - 4</td> <td data-bbox="992 1800 1271 1825">Continuity(short circuit)</td> </tr> </tbody> </table>		Infinite Switch	Knob Position	Results		Single type	CR	Off	P1 -2	Infinite(open circuit)		P2 -4	Infinite(open circuit)			On	P1 -2	Continuity(short circuit)				P2 - 4	Continuity(short circuit)	
	Infinite Switch	Knob Position	Results																						
Single type	CR	Off	P1 -2	Infinite(open circuit)																					
			P2 -4	Infinite(open circuit)																					
		On	P1 -2	Continuity(short circuit)																					
			P2 - 4	Continuity(short circuit)																					

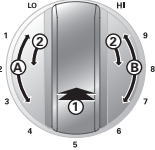
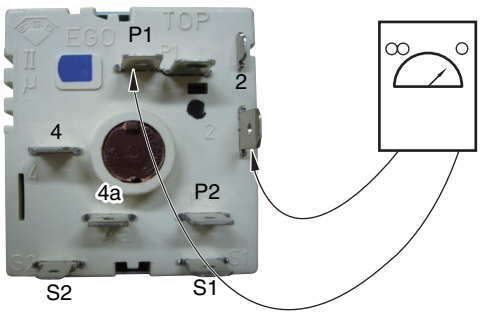
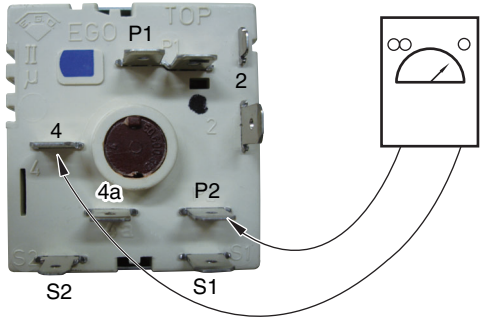
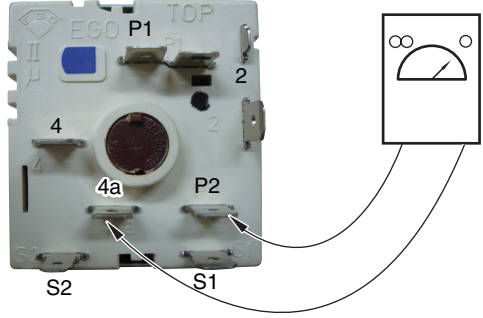

Components	Test procedures	Results
<p>Infinite switch (Double units): LF switch</p> 	<ol style="list-style-type: none"> <li>1. Refer to page 3-6 for the servicing procedure.</li> <li>2. Set the Multiple meter scale to the R x 1000.</li> <li>3. Disconnect all wires from infinite switch.</li> <li>4. Push in and turn left knob to check the single type.</li> <li>5. When turn on/turn off the knob, position measure the resistance between P1 to 2.</li> </ol>  <ol style="list-style-type: none"> <li>6. When turn on/turn off the knob, position measure the resistance between P2 to 4 and P2 to 4a.</li> </ol>  	

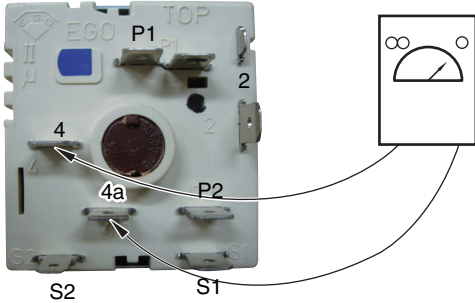
Components	Test procedures	Results
Infinite switch (Double units): LF switch	<p>7. When turn on/turn off the knob, position measure the resistance between 4 to 4a.</p>  <p>8. After check the single type, check the dual type at the same procedure.</p>	

	Infinite Switch	Knob Position	Results	
Dual type (single)	LF	Off	P1 - 2	Infinite(open circuit)
			P2 - 4	Infinite(open circuit)
			P2 - 4a	Infinite(open circuit)
			4 - 4a	Infinite(open circuit)
		On	P1 - 2	Continuity(short circuit)
			P2 - 4	Continuity(short circuit)
			P2 - 4a	Infinite(open circuit)
			4 - 4a	Infinite(open circuit)
Dual type (dual)	LF	Off	P1 - 2	Infinite(open circuit)
			P2 - 4	Infinite(open circuit)
			P2 - 4a	Infinite(open circuit)
			4 - 4a	Infinite(open circuit)
		On	P1 - 2	Continuity(short circuit)
			P2 - 4	Continuity(short circuit)
			P2 - 4a	Continuity(short circuit)
			4 - 4a	Continuity(short circuit)

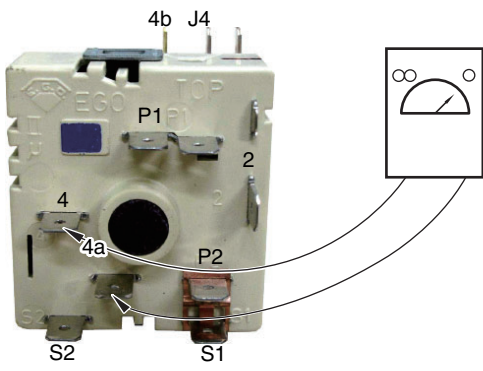
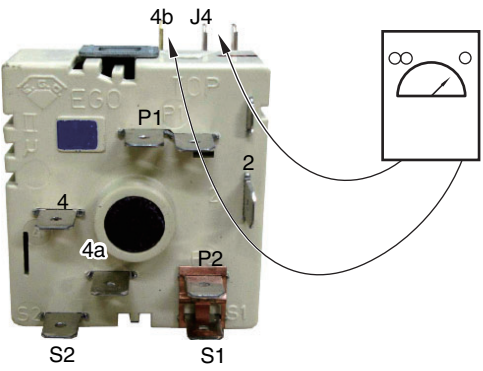

Components	Test procedures	Results																		
Infinite switch (Triple units): RF switch	<p>7. When turn on/turn off the knob, position measure the resistance between 4 to 4a.</p>  <p>8. When turn on/turn off the knob, position measure the resistance between J4 to 4b.</p>  <p>9. After check the single type, check the dual type at the same procedure.</p>																			
<table border="1"> <tr> <td></td> <td>Infinite Switch</td> <td>Knob Position</td> <td colspan="2">Results</td> </tr> <tr> <td rowspan="3">Triple type</td> <td rowspan="3">LF</td> <td>OFF</td> <td>J4-4b</td> <td>Infinite(open circuit)</td> </tr> <tr> <td>ON</td> <td>J4-4b</td> <td>Continuity(short circuit)</td> </tr> <tr> <td colspan="3">Others are same as dual circuits</td> </tr> </table>		Infinite Switch	Knob Position	Results		Triple type	LF	OFF	J4-4b	Infinite(open circuit)	ON	J4-4b	Continuity(short circuit)	Others are same as dual circuits						
	Infinite Switch	Knob Position	Results																	
Triple type	LF	OFF	J4-4b	Infinite(open circuit)																
		ON	J4-4b	Continuity(short circuit)																
		Others are same as dual circuits																		

### Components

Variable Thermostat :  
Lower oven switch

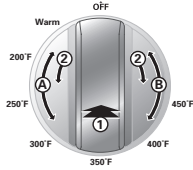

### Test procedures

1. Refer to page 3-19 for the servicing procedure.
2. Set the Multiple meter scale to the R x 1000.
3. Disconnect all wires from Variable Thermostat
4. When turn on/turn off the knob, position measure the resistance between L1 to H.

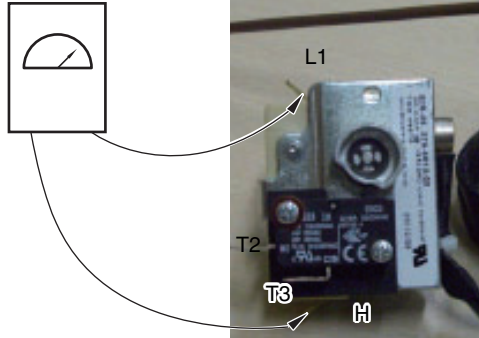

5. When turn on/turn off the knob, position measure the resistance between T2 to T3.

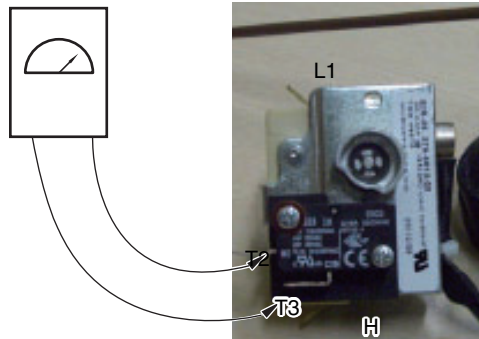

6. After check the single type, check the dual type at the same procedure.

**NOTE:**  $\Omega$  Value was tested at room temperature (75F/24°C)

Part	Knob Position	Results	
Variable Thermostat	OFF	L1-H	Infinite(open circuit)
		T2-T3	Infinite(open circuit)
	ON	L1-H	Continuity(short circuit)
		T2-T3	Continuity(short circuit)

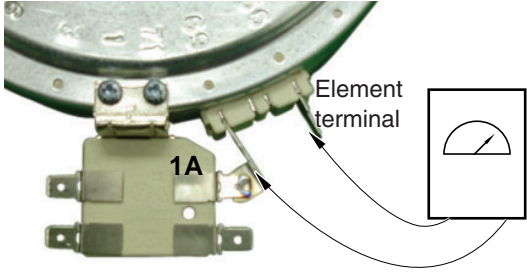
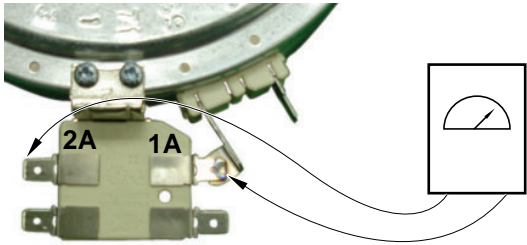
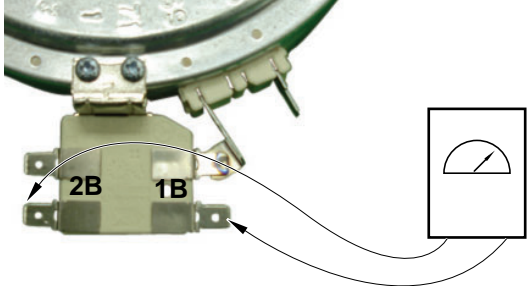

Components	Test procedures	Results
<p><b>Single surface units:</b> Left Rear (LR) and Right Rear(RR) Element</p>	<p>1. Refer to page 3-7 for the servicing procedure</p> <p>2. Set the Multiple meter scale to the R x 1</p> <p>3. Disconnect wires from cook-top elements</p> <p>4. Touch the ohmmeter test leads to the element terminal and 1A. The meter should indicate <math>46 \Omega \pm 10\%</math></p>  <p>5. Touch the ohmmeter test leads to limiter terminals 1A and 2A. The meter should indicate continuity.(0Ω)</p>  <p>6. Touch the ohmmeter test leads to limiter terminals 1B and 2B. With the temperature below 150°F, the meter should indicate an open circuit(infinite). With the temperature above 150°F, the meter should indicate continuity (0Ω).</p> 	<p>Normal: Approximately <math>46 \Omega</math>, If not replace</p> <p>Normal: continuity (below <math>0.5 \Omega</math>) If not replace</p> <p>Below 150°F → open circuit(infinite).</p> <p>Above 150°F → continuity (0 Ω)</p>

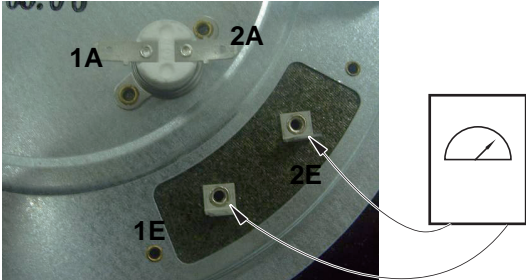
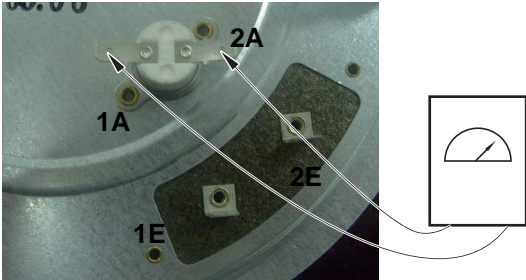
Components	Test procedures	Results
Center Rear(CR) Element : Warming Zone (Plane Heater)	<ol style="list-style-type: none"> <li>1. Refer to page 3-7 for the servicing procedure</li> <li>2. Set the Multiple meter scale to the R x 1</li> <li>3. Disconnect wires from cook-top elements</li> <li>4. Touch the ohmmeter test leads to the element terminal E1 and E2. The meter should indicate <math>570\Omega \pm 10\%</math></li> </ol>  <ol style="list-style-type: none"> <li>5. Touch the ohmmeter test leads to limiter terminals 1A and 2A With the temperature below <math>150^{\circ}\text{F}</math>, the meter should indicate an open circuit(infinite). With the temperature above <math>150^{\circ}\text{F}</math>, the meter should indicate continuity (<math>0\Omega</math>).</li> </ol> 	<p>Normal: Approximately <math>570\Omega</math>, If not replace</p> <p>Below <math>150^{\circ}\text{F}</math> → open circuit(infinite).</p> <p>Above <math>150^{\circ}\text{F}</math> → continuity (<math>0\Omega</math>)</p>

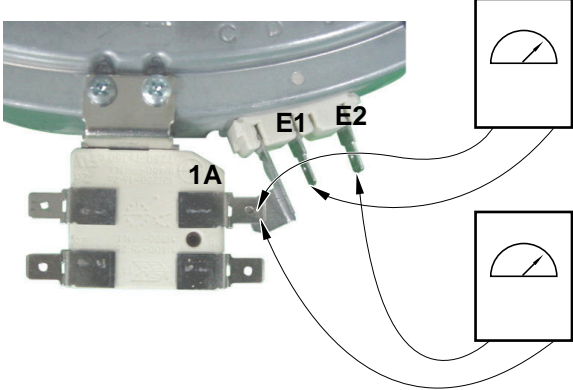
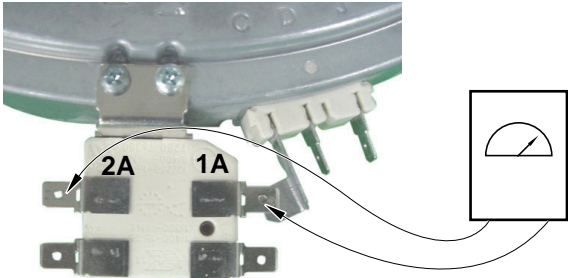
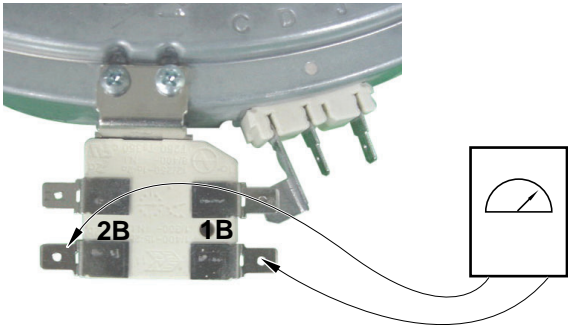
Components	Test procedures	Results
<p><b>Dual surface units:</b> Left Front(LF) Element</p>	<p>1. Refer to page 3-7 for the servicing procedure</p> <p>2. Set the Multiple meter scale to the R x1</p> <p>3. Disconnect wires from cook-top elements</p> <p>4. Touch the ohmmeter test leads to the (E1 &amp; 1A) and (E2 &amp; 1A) the meter should indicate :</p> <ul style="list-style-type: none"> <li>- (E1 &amp; 1A) → 40 Ω ± 10%</li> <li>- (E2 &amp; 1A) → 35 Ω ± 10%</li> </ul>  <p>5. Touch the ohmmeter test leads to limiter terminals 1A and 2A.the meter should indicate continuity (0 Ω)</p>  <p>6. Touch the ohmmeter test leads to limiter terminals 1B and 2B. With the temperature below 150°F, the meter should indicate an open circuit(infinite). With the temperature above 150°F, the meter should indicate continuity (0 Ω).</p> 	<p>Normal: Approximately 40 Ω</p> <p>Normal: Approximately 35 Ω</p> <p>Normal: continuity (below 0.5 Ω) If not replace</p> <p>Below 150°F → open circuit (infinite).</p> <p>Above 150°F → continuity (0 Ω)</p>

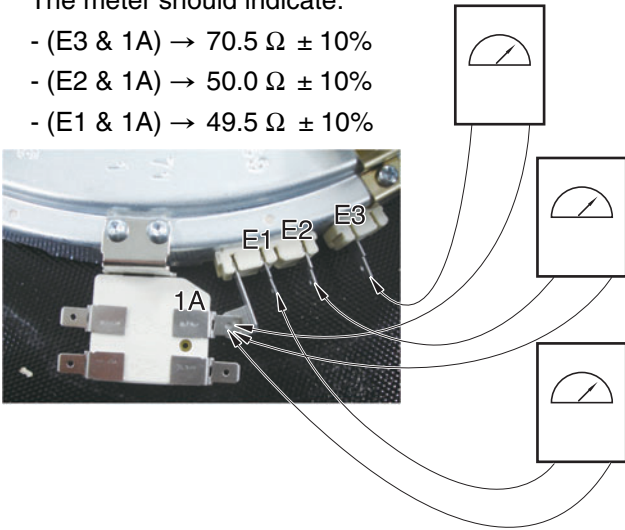
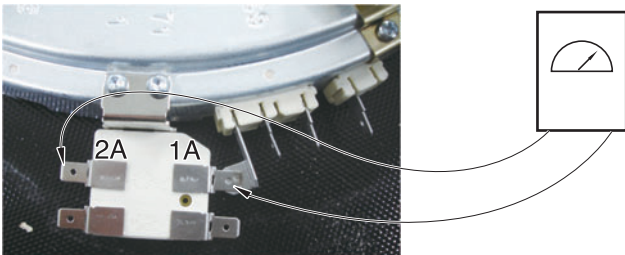
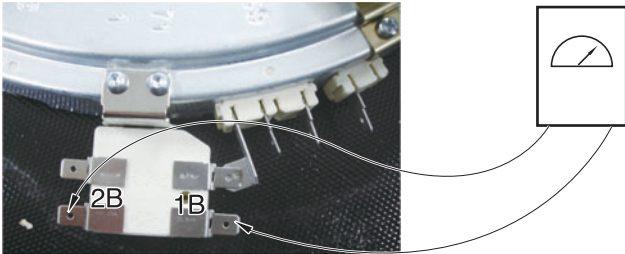
Components	Test procedures	Results
<p><b>Triple surface unit: Right Front(RF) Element</b></p>	<p>1. Refer to page 3-7 for the servicing procedure</p> <p>2. Set the Multiple meter scale to the R x 1</p> <p>3. Disconnect wires from cook-top elements</p> <p>4. Touch the ohmmeter test leads to the (E1 &amp; 1A) and (E2 &amp; 1A) and (E3 &amp; 1A) The meter should indicate.</p> <ul style="list-style-type: none"> <li>- (E3 &amp; 1A) → 70.5 Ω ± 10%</li> <li>- (E2 &amp; 1A) → 50.0 Ω ± 10%</li> <li>- (E1 &amp; 1A) → 49.5 Ω ± 10%</li> </ul>  <p>5. Touch the ohmmeter test leads to limiter terminals 1A and 2A. The meter should indicate continuity(0Ω)</p>  <p>6. Touch the ohmmeter test leads to limiter terminals 1B and 2B. With the temperature below 150 °F, the meter should indicate an open circuit(infinite). With the temperature above 150 °F, the meter should indicate continuity (0Ω).</p> 	<p>Normal: Approximately 70.5 Ω</p> <p>Normal: Approximately 50 Ω</p> <p>Normal: Approximately 49.5 Ω</p> <p>Normal: continuity (below 0.5 Ω) If not replace</p> <p>Below 150°F → open circuit(infinite).</p> <p>Above 150°F → continuity (0 Ω)</p>



# COMPOSITION OF CONTROL

**Main PCB ( P/N : EBR52349505 )**

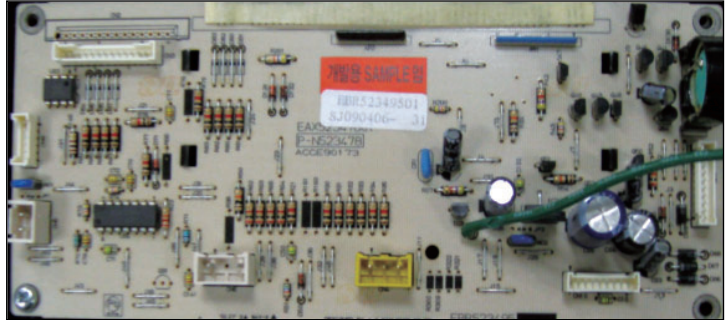

**Power PCB ( P/N : EBR57124701 )**

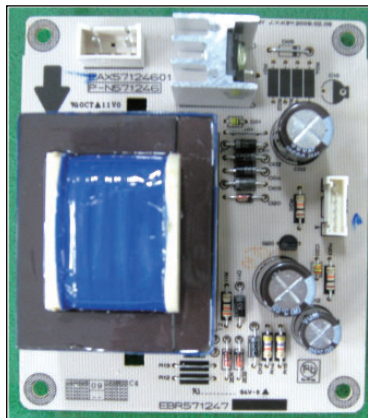

**Relay PCB ( P/N : EBR60938302 )**

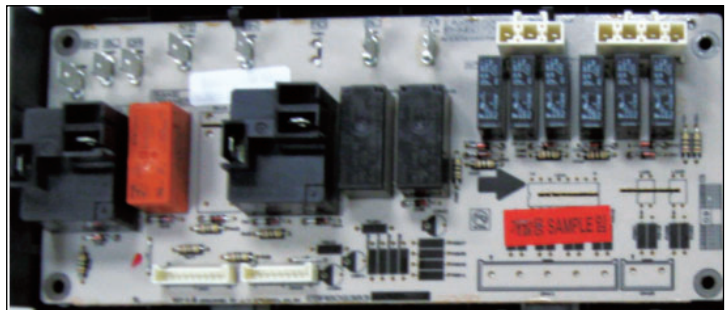

**Key PCB ( P/N : EBR60939401 )**

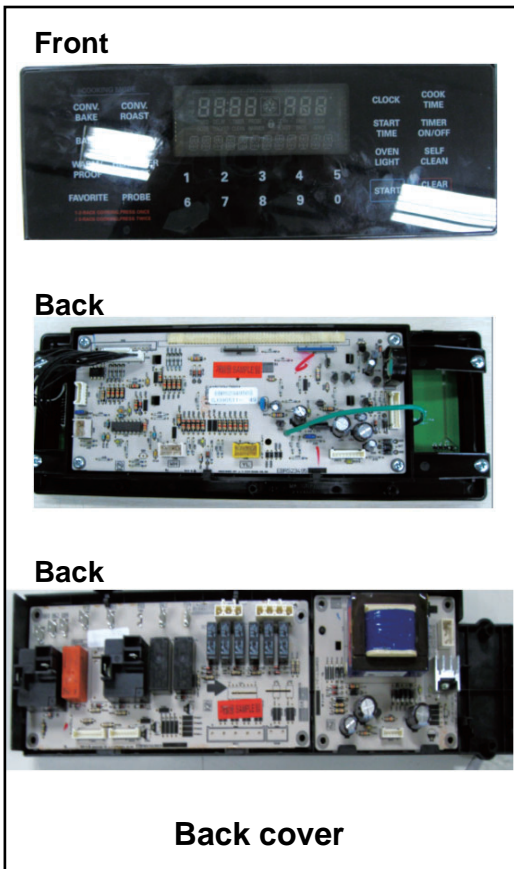
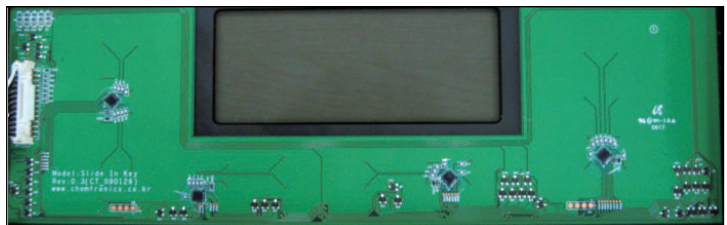

**Controller assembly**



# COMPOSITION OF CONTROL

## Main PCB

P/N : EBR52349505

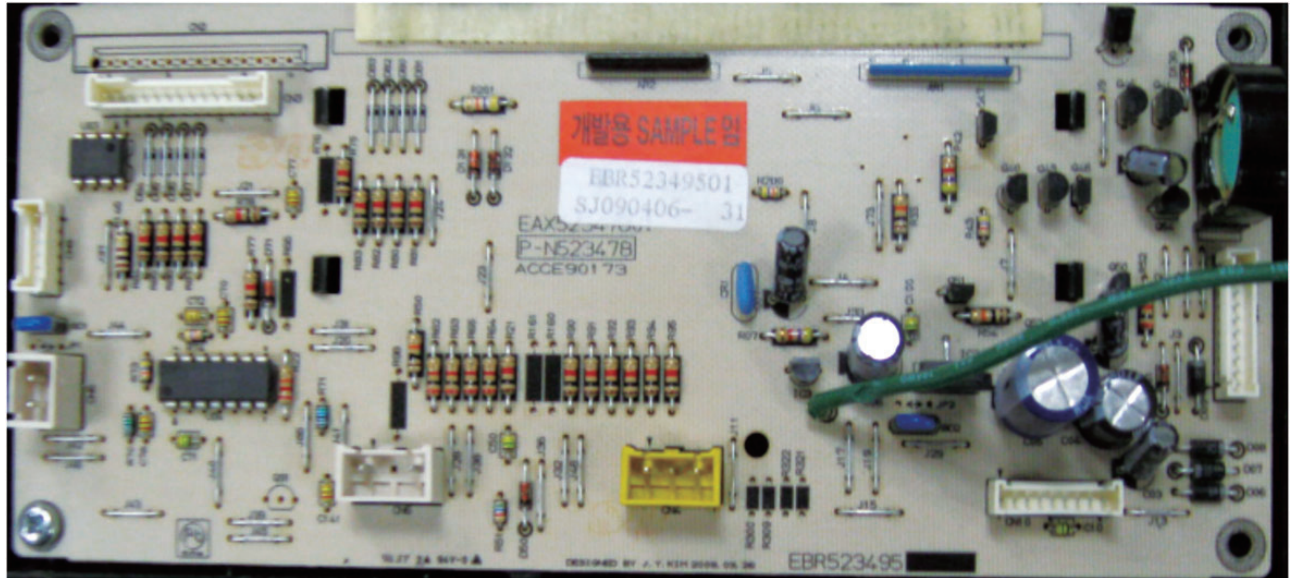

## Power PCB

P/N EBR57124701

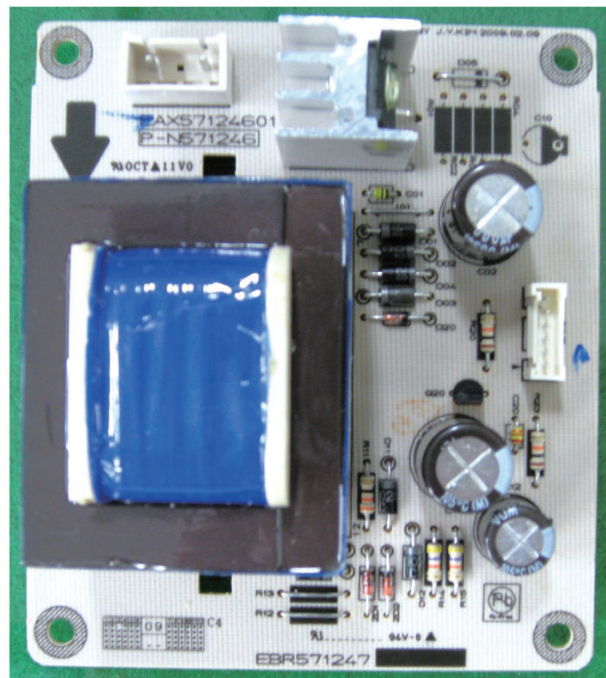

# COMPOSITION OF CONTROL

## Relay PCB

EBR60938302

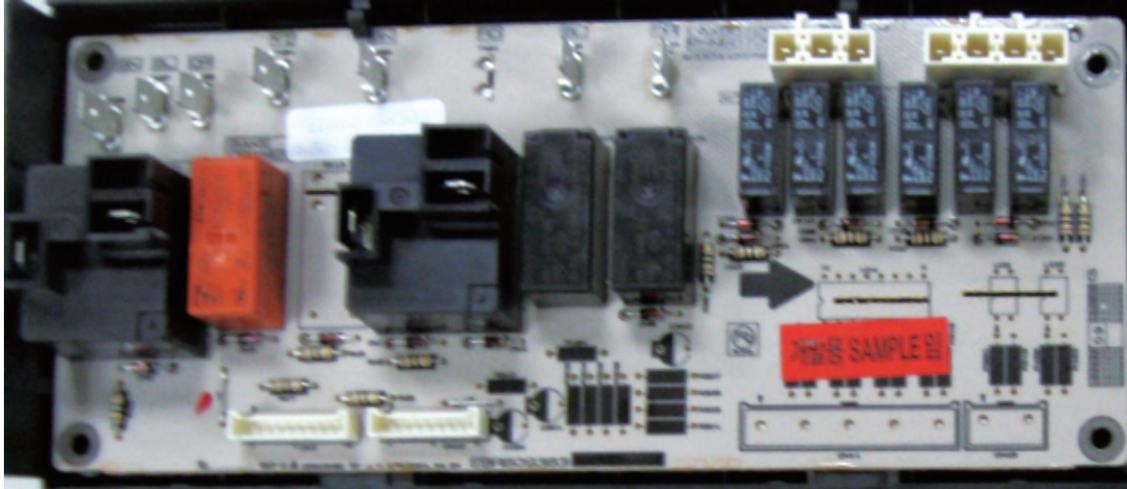

## Key PCB

P/N EBR52350001



# FAILURE MODE FLOW CHART

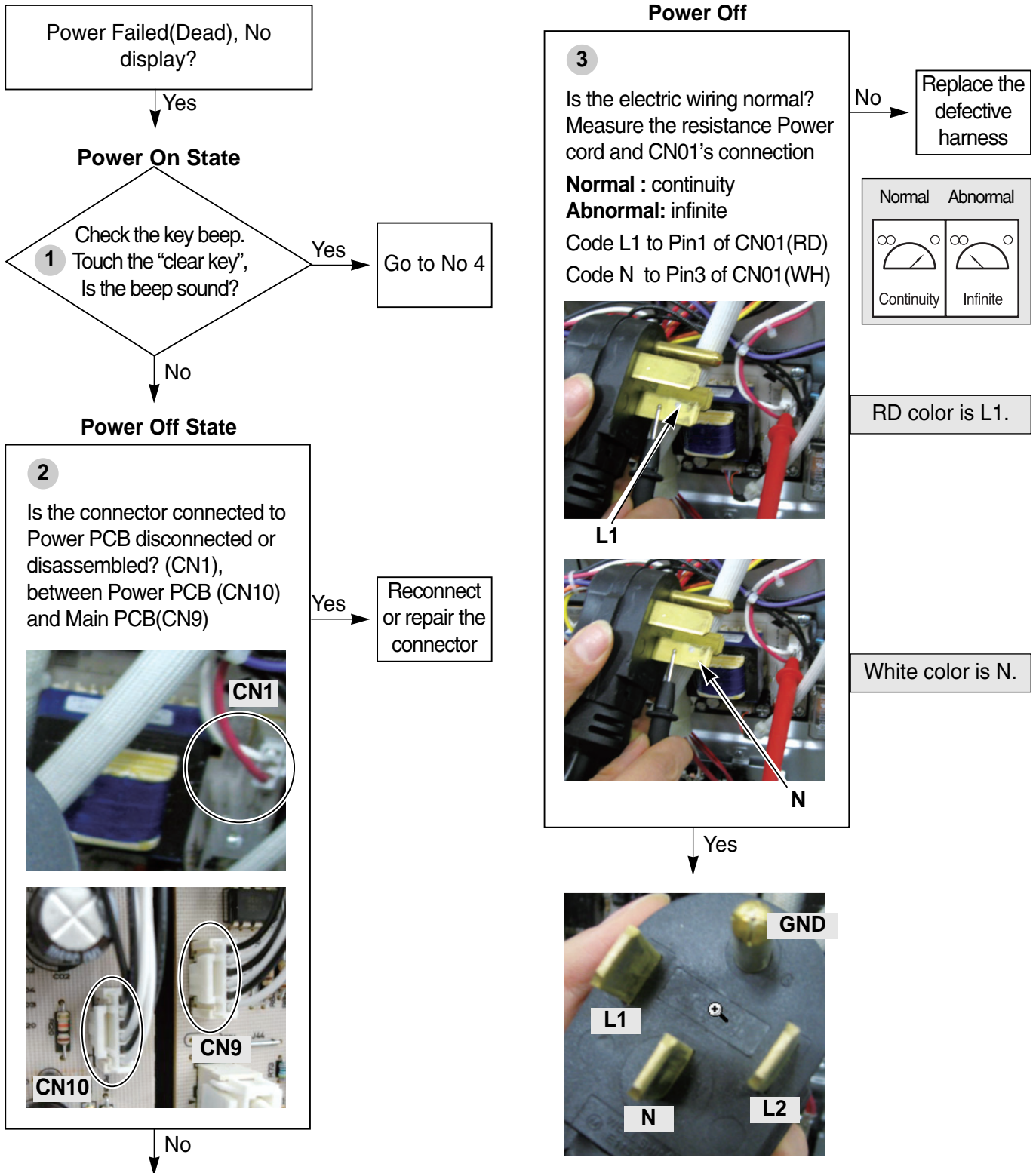



# FAILURE MODE FLOW CHART

Power Off

4

Check the voltage of Power PCB  
Is the voltage as below?

No → Replace the Power PCB

PIN No. of CN10	Voltage
PIN2 ~ PIN3(GND)	approximately approximately
PIN4 ~ PIN3(GND)	approximately -24 ~ -35[V]
PIN5 ~ PIN6	approximately AC 3.4~ 4.6 [V]

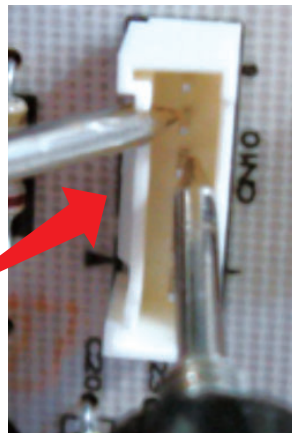
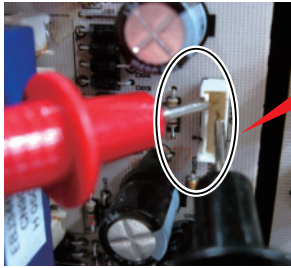

Yes

Power Off

5

Is the voltage of Main PCB's Vcc 4.5V ~ 5.5V? Check the voltage between pin2 and pin3 of IC2

No → Replace the Main PCB

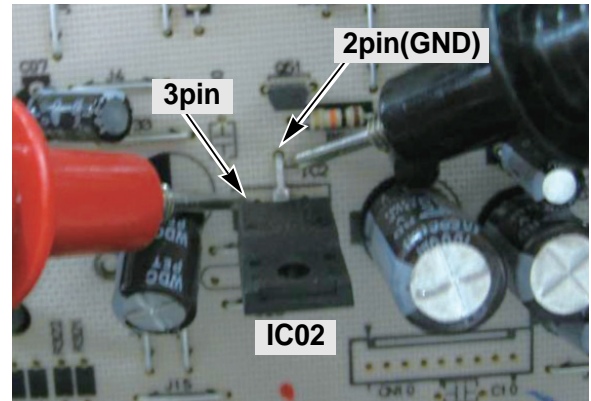

6

Check the voltage of Main PCB Is the voltage as below?

No → Replace the harness (CN9 to CN10)

PIN No. of CN9	Voltage
PIN4 ~ PIN5(GND)	approximately -24 ~ -35[V]
PIN5 ~ PIN6	approximately AC 3.4~ 4.6 [V]

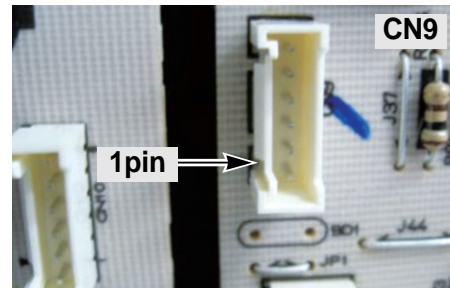

Yes

Replace the Main PCB

# FAILURE MODE FLOW CHART

Symptom	Check Point
1. No heating 2. F11	1. Check Electric Wiring 2. Check Heater's Resistance. 3. Check the Sensor.

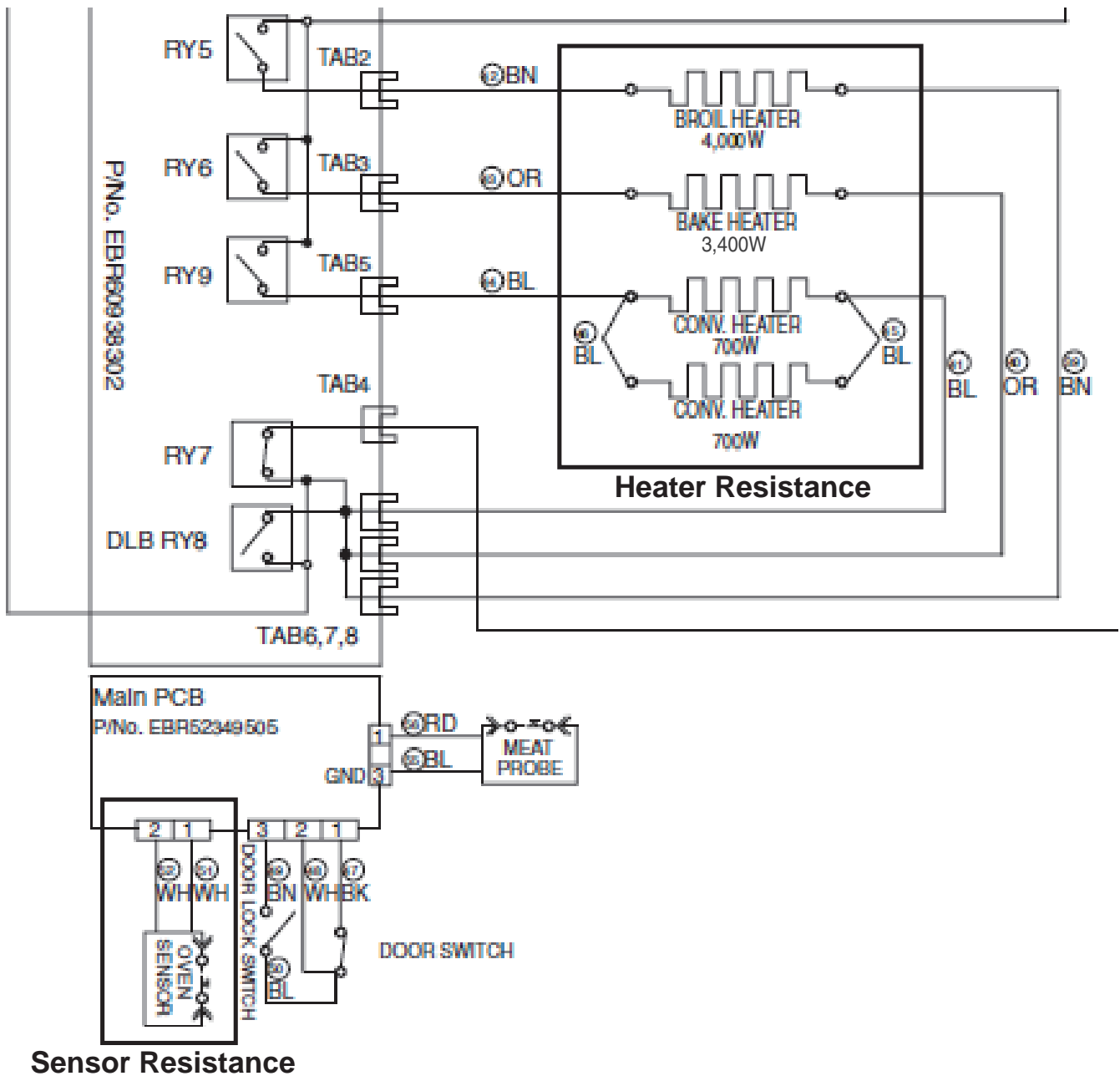



# FAILURE MODE FLOW CHART

Oven does not heat, F-11

Yes

**Power Off**

**1**

Is the disconnect or loose connector?  
 1. Between Main PCB and Relay PCB (CN7,CN10)  
 2. Electric wiring of relay PCB  
 All taps.  
 3. Electric wiring of electric element

No

Reconnect or repair the connector

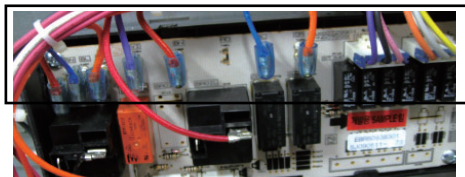
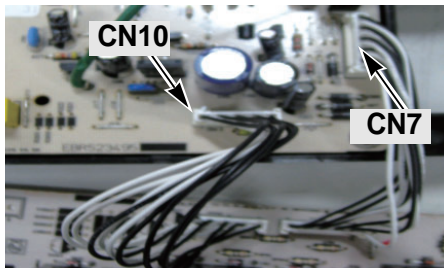

All taps.

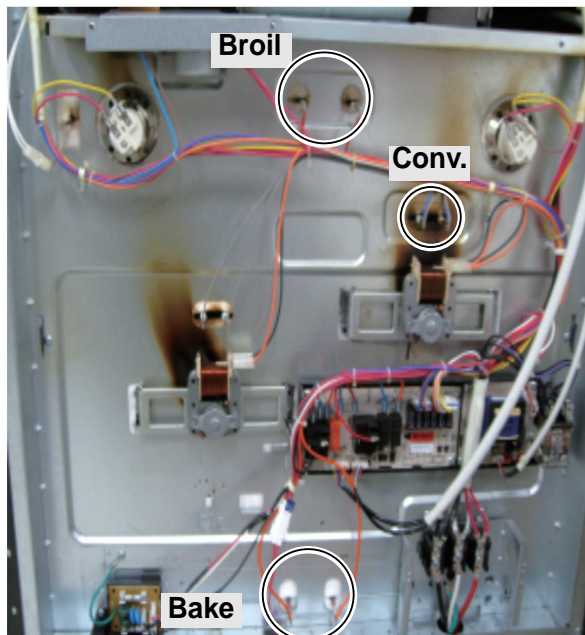

Broil

Conv.

Bake

No

**Power Off**

**2**

Is the heater normal?

No

Replace the Failed heater

Measure the resistance of each heater.  
 (The resistance is shown below)

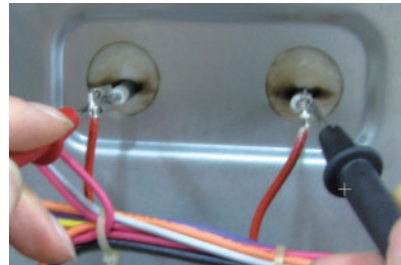

Broil.

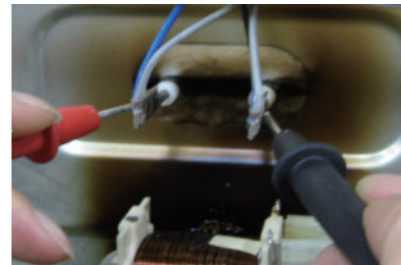

Bake

Range Of the resistance

Heater	Resistance[Ω] Approximately
Broil	13.0
Bake	17.0
Convection	80

yes

# FAILURE MODE FLOW CHART

3

## Range Of the resistance

Heater	Resistance[Ω] Approximately
Broil	13.0
Bake	17.0
Convection	80

Yes

## Power On

4

Is the value of thermistor normal?

Check: using the test mode

Yes

Go to No 6

To enter the test mode, follow these steps:

1. press the "CLEAR" key
2. press the "BAKE", "BROIL" key at the same time



3. press the "BAKE", "BROIL" key at the same time again.

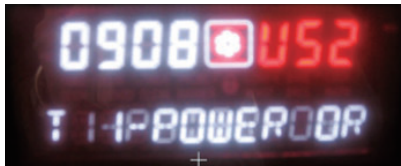

4. press the NUM "3" key

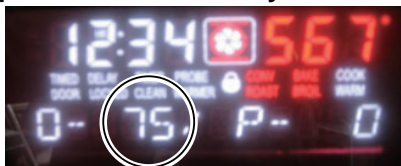

**Normal** : the sensor value is from 70\_ to 90° F at 25° C.

No

## Power Off

5

Is the resistance of thermistor normal?

No

Replace the failed thermistor

Check:

Pins 1 and 2 of CN5 wiring in main PCB  
**Normal**- approximately 1.09\_ at 25\_

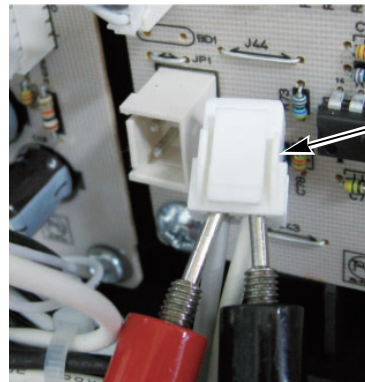

CN5

No

6

Replace the Relay PCB  
(EBR60938302)

If it doesn't work even though changing the Relay PCB, you should replace the Main PCB.(EBR52349505)

# FAILURE MODE FLOW CHART

Symptom	Check Point
1. Door Lock System Failure 2. F-10	1. Check Electric Wiring 2. Check Motor's Resistance. 3. Check the Relay PCB (Lock Motor Relay)

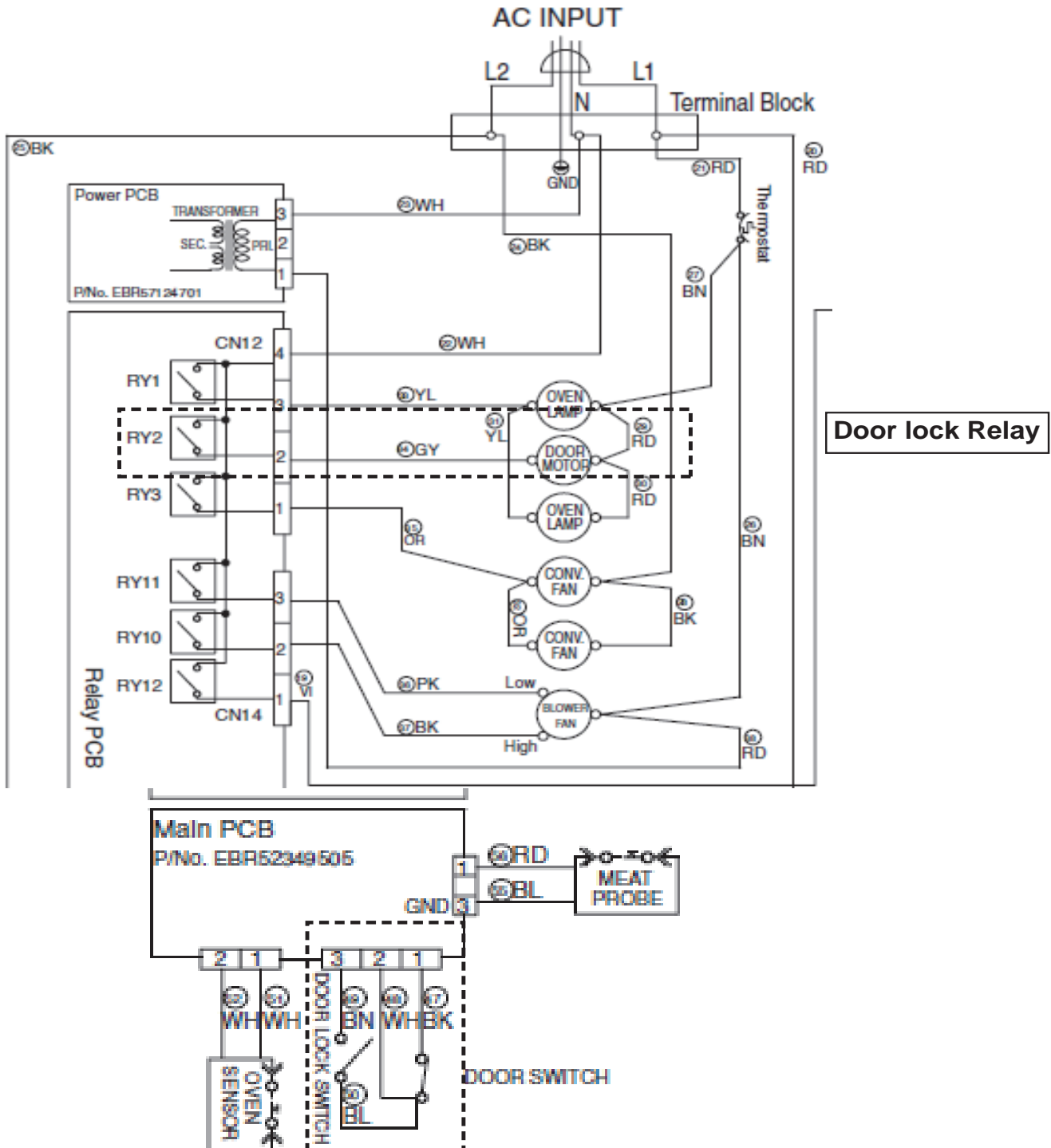

# FAILURE MODE FLOW CHART

Door Lock System Failure, F-10?

Yes

**Note :**

Just after self-clean start, the door lock motor starts to rotate. During that time if the door lock switch does not operate properly after rotating twice, then supervising circuit detects a Door Lock failure and the F-10 error code appears.

**Power Off**

**1**

Is the disconnect or loose connector?

Yes

Reconnect or repair the connector

1. Between Main PCB and Relay PCB (CN7, CN10)
2. Electric wiring of relay PCB (CN12)
3. Electric wiring of Locking Motor and Micro Switch
4. Electric wiring of CN4 of Main PCB

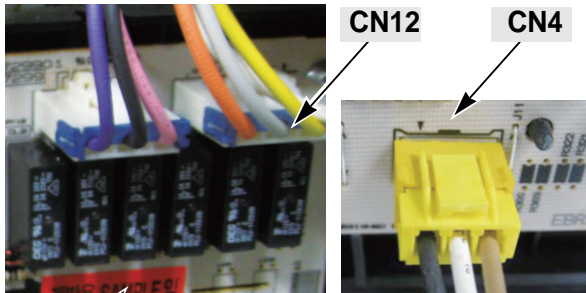

CN7

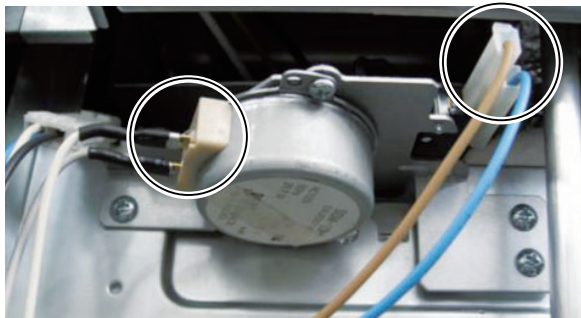

Yes

**Power Off**

**2**

Is the door lock switch (micro switch) normal?

Yes

Replace the micro switch

measure the resistance of door lock switch → normally open type

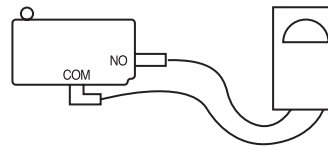
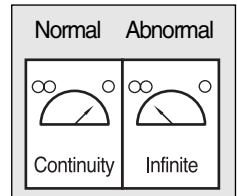

Yes

**Power Off**

**3**

Is the resistance of the locking motor normal ?

No

Replace the locking motor

measure the resistance of locking motor

Normal : approximately 2.6kΩ  
Abnormal : infinite or below 5 Ω



Yes

Replace the Relay PCB (EBR52349701)

# FAILURE MODE FLOW CHART

Symptom	Check Point
1. Sensing Fail 2. F-1 3. F-2	1. Check the Electric Wiring 2. Check the Test Mode 3. Check the Sensor's Resistance

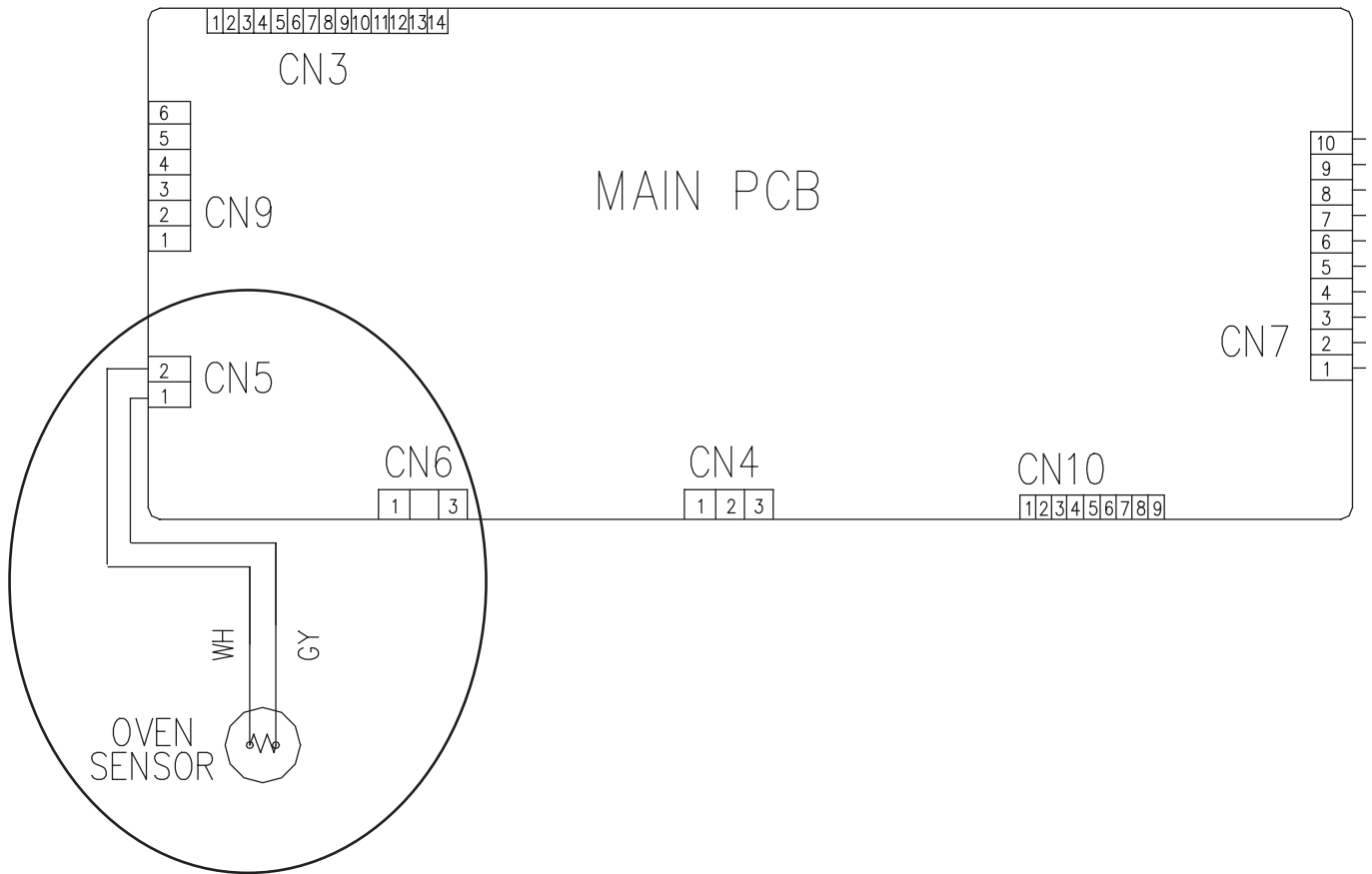



# FAILURE MODE FLOW CHART

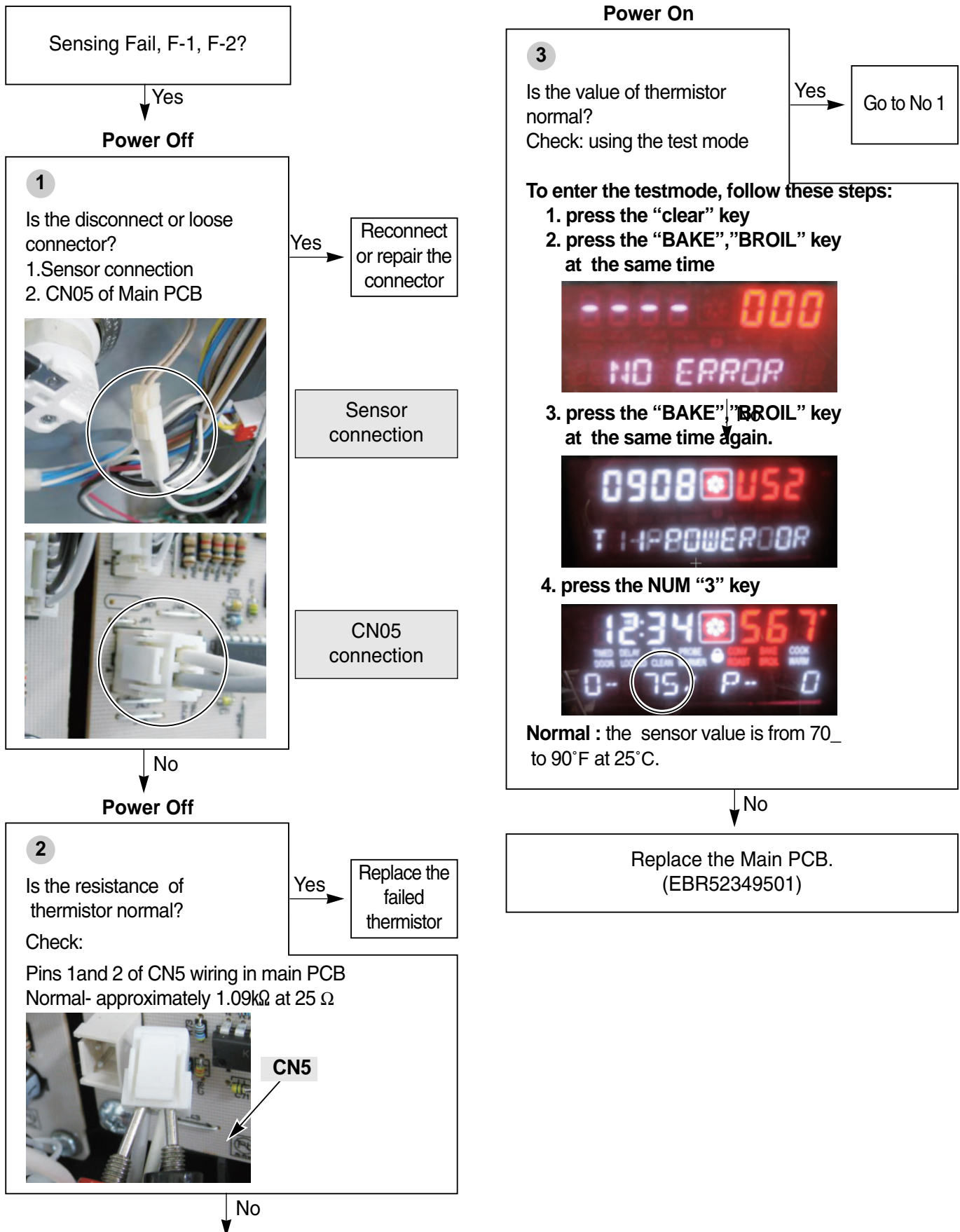

# FAILURE MODE FLOW CHART

Symptom	Check Point
1. Oven hot 2. F-6	1. Check the Resistance of the Relay.

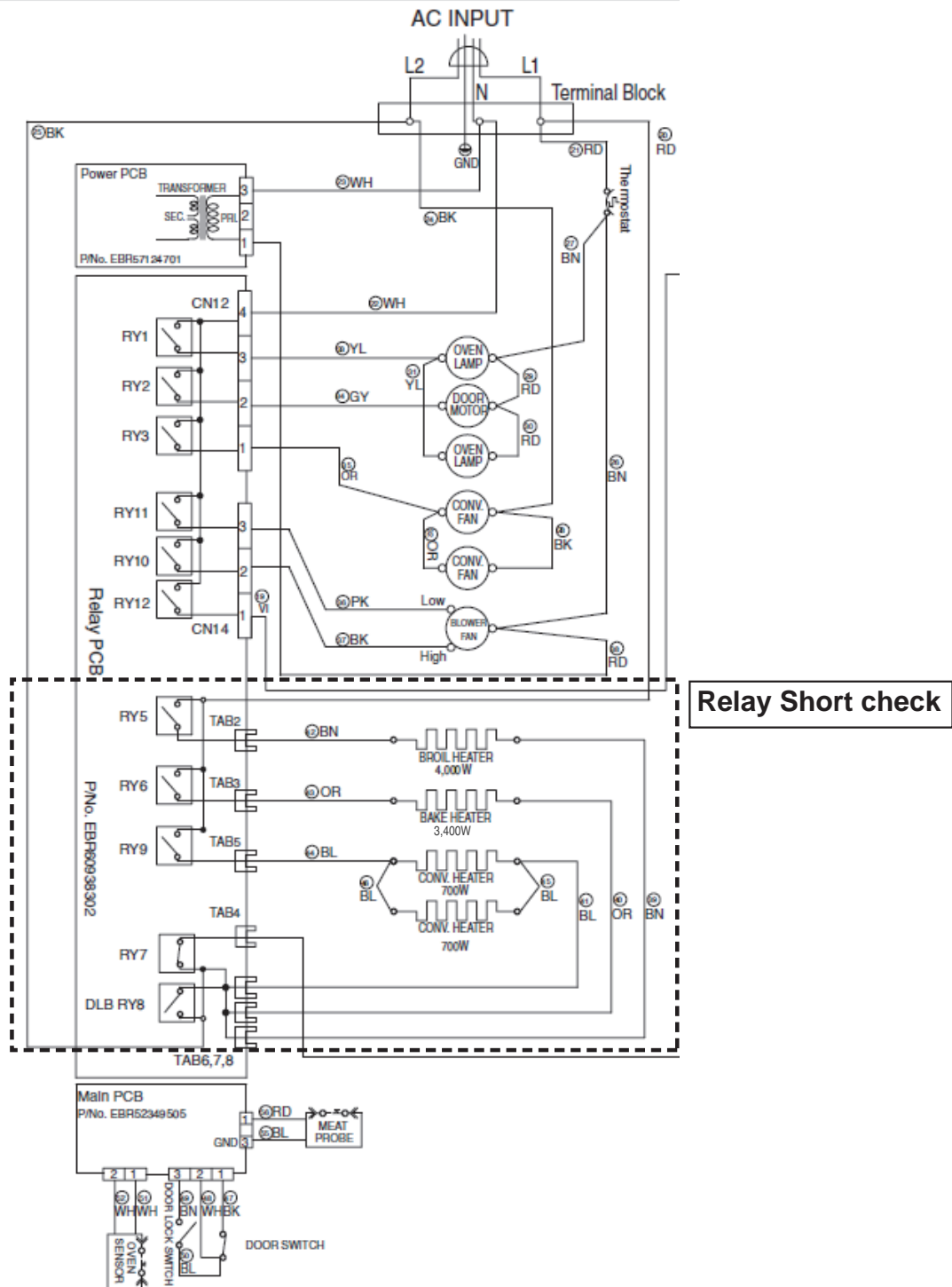

# FAILURE MODE FLOW CHART

Oven too hot, F-6, F-16?

Yes

**Power Off**

**1**

Is the resistance of thermistor normal?

No

Replace the failed thermistor

Check:

Pins 1 and 2 of CN5 wiring in main PCB  
Normal- approximately 1.09kΩ at 25 Ω

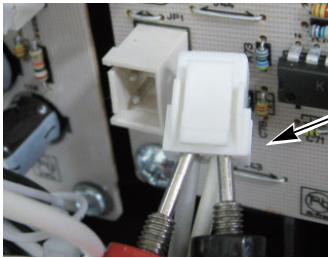

CN5

Yes

**Power Off**

**2**

Is the Heater relay normal?

No

Replace the failed thermistor

Measure the resistance of heater relay and L.

**Normal** : infinite

**Abnormal** : continuity

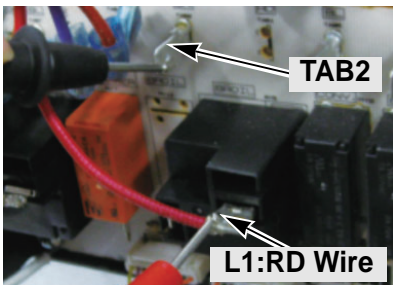

TAB2

L1:RD Wire

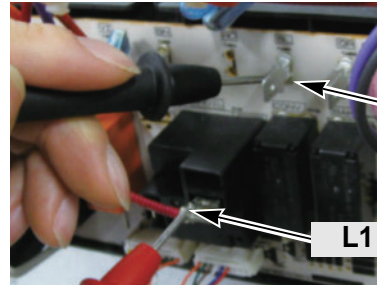

TAB5

L1

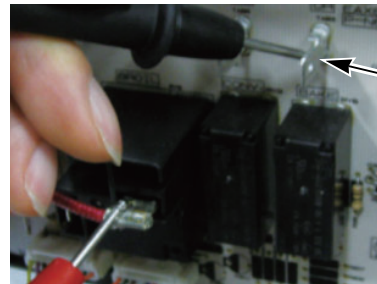

TAB3

Yes

**Power Off**

**3**

Is the DLB relay normal?  
Measure the resistance

Yes

Replace the relay PCB  
(EBR60938302)

**Normal** : infinite  
**Abnormal** : continuity

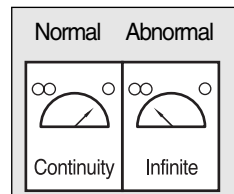
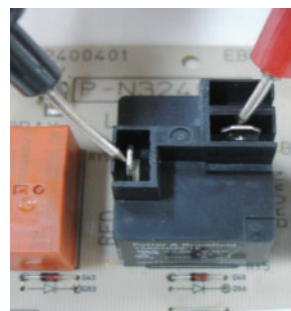

Yes

# FAILURE MODE FLOW CHART

## Power On

4

Is the value of thermistor normal?  
Check: using the test mode

No

Replace  
the Main PCB  
(EBR52349505)

To enter the testmode, follow these steps:

1. press the "clear" key
2. press the "BAKE", "BROIL" key at the same time



3. press the "BAKE", "BROIL" key at the same time again.

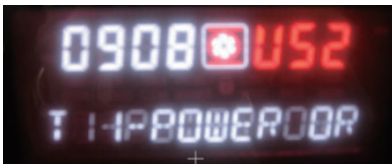

4. press the NUM "3" key



**Normal** : the sensor value is from 70°F to 90°F at 25°C.

# FAILURE MODE FLOW CHART

Symptom	Check Point
1. Keypad Failure 2. F-3 Error	1. Check the Door Locking System. 2. Check the Electric Wiring.

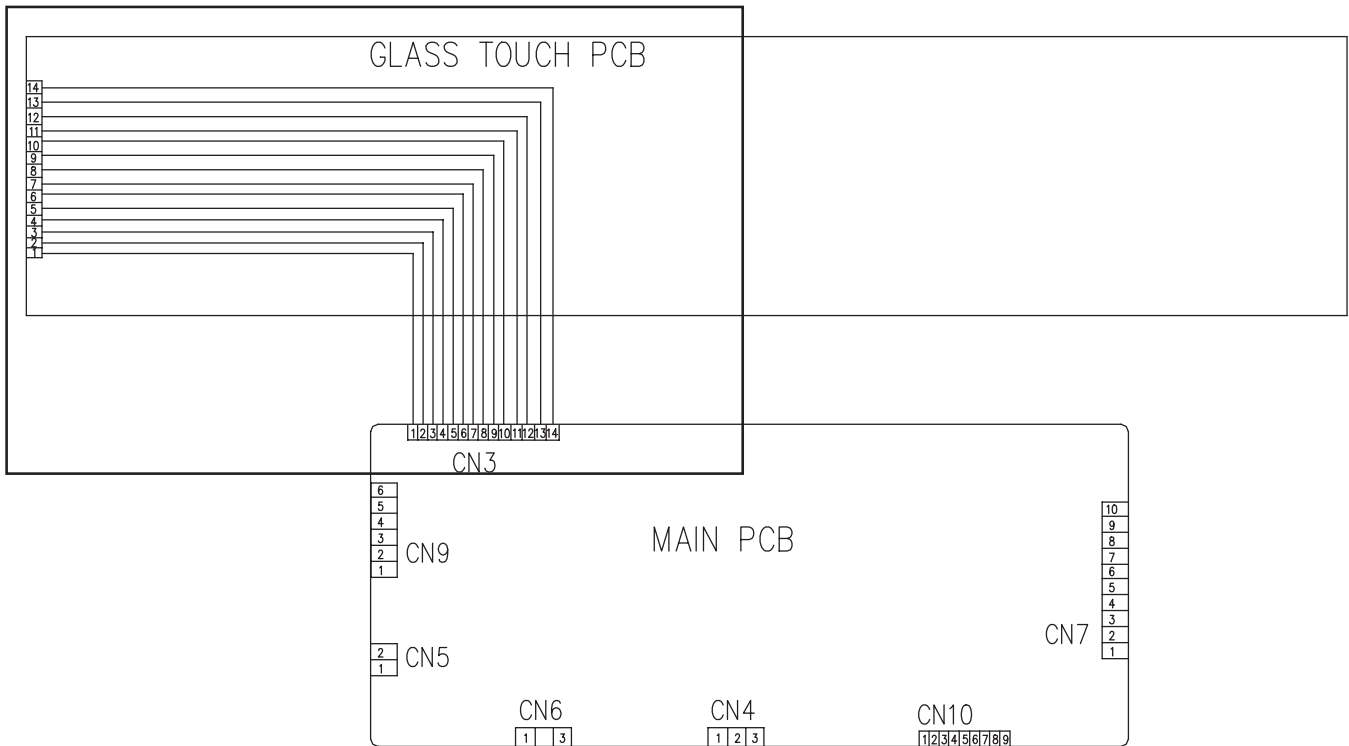



# FAILURE MODE FLOW CHART

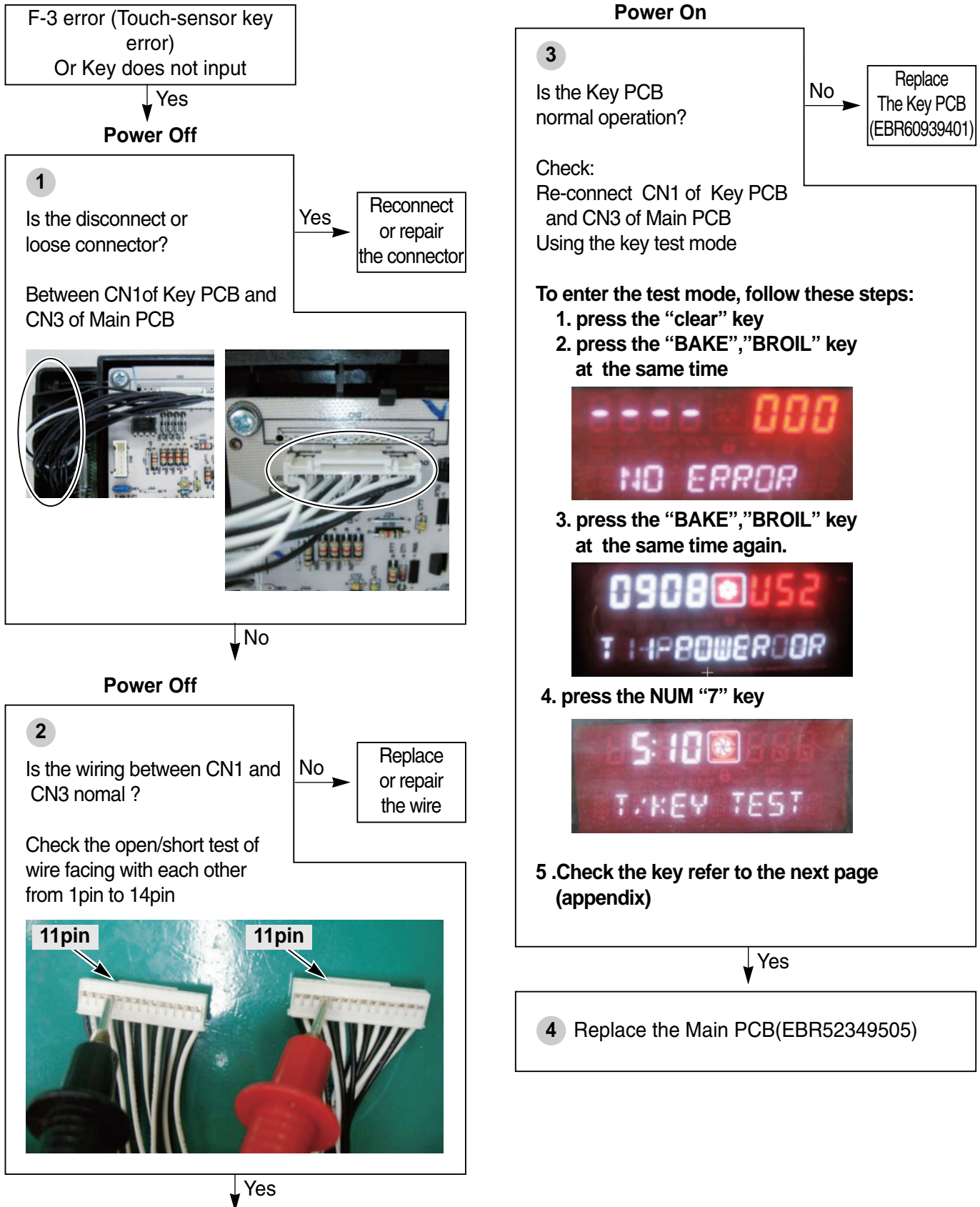

# APPENDIX

## Key operation Test

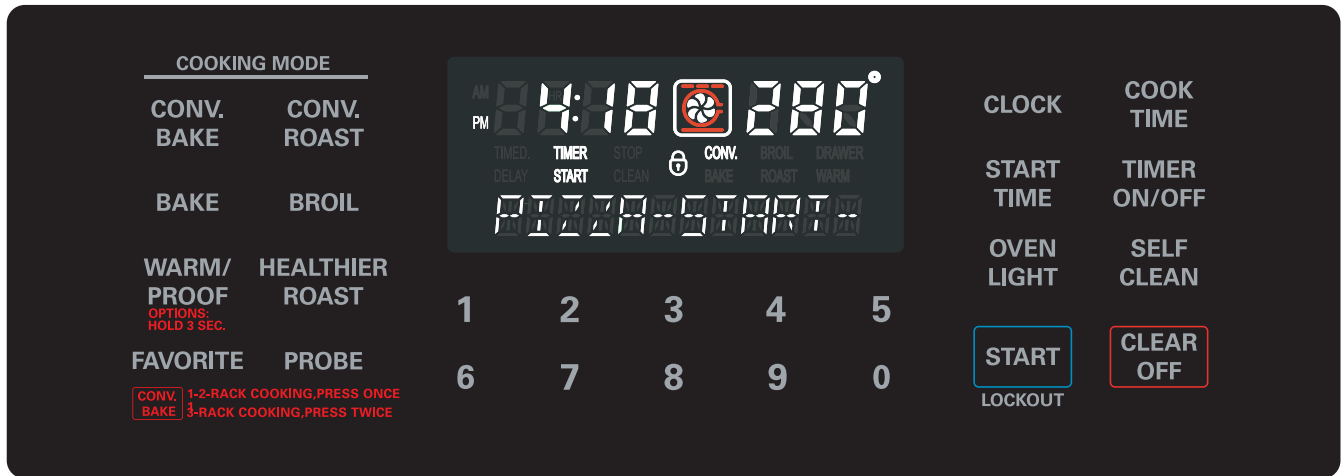

### ※ How to check Key operation

1. Keys should be accessed according to priority and check the buzzer operation when key is accessed
2. If change the key access order, the buzzer make another beep
3. The buzzer has no operation when key accessed, , it would be defected.

### ※ How to stop - Key Test mode

- Press 1st \_ 2nd \_... \_28th\_26th (CLEAR)
- Press 'CLEAR'

# TROUBLE SHOOTING

## BEFORE CALLING FOR SERVICE

Before you call for service, review this list. It may save you time and expense. The list includes common occurrences that are not the result of defective workmanship or materials in this appliance.

Problem	Possible Causes / Solutions						
Range is not level.	<ul style="list-style-type: none"> <li>• Poor installation. Place oven rack in center of oven. Place a level on the oven rack. Adjust leveling legs at base of range until the oven rack is level.</li> <li>• Be sure floor is level and strong and stable enough to adequately support range.</li> <li>• If floor is sagging or sloping, contact a carpenter to correct the situation.</li> <li>• Kitchen cabinet alignment may make range appear unlevel. Be sure cabinets are square and have sufficient room for range clearance.</li> </ul>						
Cannot move appliance easily. Appliance must be accessible for service.	<ul style="list-style-type: none"> <li>• Cabinets not square or are built in too tightly. Contact builder or installer to make appliance accessible.</li> <li>• Carpet interferes with range. Provide sufficient space so range can be lifted over carpet.</li> </ul>						
Oven control beeps and displays any F code error.	<ul style="list-style-type: none"> <li>• Electronic control has detected a fault condition. Touch <b>CLEAR/OFF</b> to clear the display and stop beeping. Reprogram oven. If fault recurs, record fault number. Touch <b>CLEAR/OFF</b> and contact a Service agent.</li> </ul> <table border="1" data-bbox="1032 917 1430 1019"> <thead> <tr> <th data-bbox="1032 917 1133 944">CODE</th> <th data-bbox="1133 917 1430 944">CAUSE</th> </tr> </thead> <tbody> <tr> <td data-bbox="1032 944 1133 981">F-3</td> <td data-bbox="1133 944 1430 981">Shorted keypad</td> </tr> <tr> <td data-bbox="1032 981 1133 1019">F-11</td> <td data-bbox="1133 981 1430 1019">No heating</td> </tr> </tbody> </table>	CODE	CAUSE	F-3	Shorted keypad	F-11	No heating
CODE	CAUSE						
F-3	Shorted keypad						
F-11	No heating						
Surface units will not maintain a rolling boil or cooking is not fast enough	<ul style="list-style-type: none"> <li>• Improper cookware being used.               <ul style="list-style-type: none"> <li>- Use pans which are flat and match the diameter of the surface unit selected.</li> </ul> </li> <li>• In some areas, the power (voltage) may be low.               <ul style="list-style-type: none"> <li>- Cover pan with a lid until desired heat is obtained.</li> </ul> </li> </ul>						
Surface units do not work properly	<ul style="list-style-type: none"> <li>• A fuse in your home may be blown or the circuit breaker tripped.               <ul style="list-style-type: none"> <li>- Replace the fuse or reset the circuit breaker.</li> </ul> </li> <li>• Cooktop controls improperly set.               <ul style="list-style-type: none"> <li>- Check to see the correct control is set for the surface unit you are using.</li> </ul> </li> </ul>						
Surface unit stops glowing when changed to a lower setting	<ul style="list-style-type: none"> <li>• This is normal. The unit is still on and hot.</li> </ul>						
Areas of discoloration on the cooktop	<ul style="list-style-type: none"> <li>• Food spillovers not cleaned before next use.               <ul style="list-style-type: none"> <li>- See <b>Cleaning the Glass/Ceramic Cooktop</b> section in the <b>User's Guide</b>.</li> </ul> </li> <li>• Hot surface on a model with a light-colored cooktop.               <ul style="list-style-type: none"> <li>- This is normal. The surface may appear discolored when it is hot. This is temporary and will disappear as the glass cools.</li> </ul> </li> </ul>						
Frequent cycling on and off of surface units	<ul style="list-style-type: none"> <li>• This is normal.               <ul style="list-style-type: none"> <li>- The element will cycle on and off to maintain the heat setting.</li> </ul> </li> </ul>						

# TROUBLE SHOOTING

Problem	Possible Causes / Solutions
<b>Oven will not work</b>	<ul style="list-style-type: none"> <li>• Plug on range is not completely inserted in the electrical outlet.               <ul style="list-style-type: none"> <li>- Make sure electrical plug is plugged into a live, properly grounded outlet.</li> </ul> </li> <li>• A fuse in your home may be blown or the circuit breaker tripped.               <ul style="list-style-type: none"> <li>- Replace the fuse or reset the circuit breaker.</li> </ul> </li> <li>• Oven controls improperly set.               <ul style="list-style-type: none"> <li>- See the Using your range section.</li> </ul> </li> <li>• Oven too hot.               <ul style="list-style-type: none"> <li>- Allow the oven to cool to below locking temperature.</li> </ul> </li> </ul>
<b>Appliance does not operate.</b>	<ul style="list-style-type: none"> <li>• Make sure cord is plugged correctly into outlet. Check circuit breakers.</li> <li>• Service wiring is not complete. Contact your appliance Servicer for assistance.</li> <li>• Power outage. Check house lights to be sure. Call your local electric company for service.</li> </ul>
<b>Oven control displays PF message.</b>	<ul style="list-style-type: none"> <li>• The PF message will appear whenever there has been a power interruption to the appliance. To clear the PF message touch CLEAR/OFF control pad and be sure to reset the clock with the correct time of day.</li> </ul>
<b>Oven light does not work.</b>	<ul style="list-style-type: none"> <li>• Replace or tighten bulb. See <b>Care &amp; Cleaning</b> section in the User's Guide</li> </ul>
<b>Oven smokes excessively during broiling.</b>	<ul style="list-style-type: none"> <li>• Control not set properly. Follow instructions under Setting Oven Controls.</li> <li>• Meat too close to the element. Reposition the rack to provide proper clearance between the meat and the element. Preheat broil element for searing.</li> <li>• Meat not properly prepared. Remove excess fat from meat. Cut remaining fatty edges to prevent curling.</li> <li>• Insert on broiler pan wrong side up and grease not draining. Always place grid on the broiler pan with ribs up and slots down to allow grease to drip into pan.</li> <li>• Grease has built up on oven surfaces. Regular cleaning is necessary when broiling frequently. Old grease or food spatters cause excessive smoking.</li> </ul>
<b>Food does not bake or roast properly</b>	<ul style="list-style-type: none"> <li>• Oven controls improperly set.               <ul style="list-style-type: none"> <li>- See the <b>OPERATING INSTRUCTIONS</b> section in the User's Guide.</li> </ul> </li> <li>• Rack position is incorrect or the rack is not level.               <ul style="list-style-type: none"> <li>- See the <b>OPERATING INSTRUCTIONS</b> section in the User's Guide.</li> </ul> </li> <li>• Incorrect cookware or cookware of improper size being used.               <ul style="list-style-type: none"> <li>- See the <b>OPERATING INSTRUCTIONS</b> section in the User's Guide.</li> </ul> </li> <li>• Oven sensor needs to be adjusted.               <ul style="list-style-type: none"> <li>- See the thermostat adjustment in the special function section.</li> </ul> </li> </ul>
<b>Food does not broil properly</b>	<ul style="list-style-type: none"> <li>• Oven controls improperly set.               <ul style="list-style-type: none"> <li>- Make sure you touch the <b>BROIL</b> pad.</li> </ul> </li> <li>• Improper rack position being used.               <ul style="list-style-type: none"> <li>- See the <b>Broiling Guide</b>, page 27 in the User's Guide..</li> </ul> </li> <li>• Cookware not suited for broiling.               <ul style="list-style-type: none"> <li>- Use the broiling pan and grid that came with your range.</li> </ul> </li> </ul>

# TROUBLE SHOOTING

Problem	Possible Causes / Solutions
<b>Food does not broil properly</b>	<ul style="list-style-type: none"> <li>• Aluminum foil used on the the broiling pan and grid has not been fitted properly and slit as recommended.                             <ul style="list-style-type: none"> <li>- See the Broil section in the User's Guide.</li> </ul> </li> <li>• In some areas the power voltage may be low.                             <ul style="list-style-type: none"> <li>- Preheat the broil element for 5-7 minutes</li> <li>- See the <b>Broiling Guide</b>, page 27 in the User's Guide.</li> </ul> </li> </ul>
<b>Oven temperature too hot or too cold</b>	<ul style="list-style-type: none"> <li>• Oven Sensor needs to be adjusted.                             <ul style="list-style-type: none"> <li>- See thermostat adjustment in the special function section.</li> </ul> </li> </ul>
<b>Scratches or abrasions on cooktop surface</b>	<ul style="list-style-type: none"> <li>• Coarse particles such as salt or sand between cooktop and utensils can cause scratches. Be sure cooktop surface and bottoms of utensils are clean before usage. Small scratches do not affect cooking and will become less visible with time.</li> <li>• Cleaning materials not recommended for ceramic-glass cooktop have been used. See <b>Cleaning the Glass/Ceramic Cooktop</b> in the MAINTENANCE section, page 42-43 in the User's Guide.</li> <li>• Cookware with rough bottom has been used. Use smooth, flat-bottomed cookware.</li> </ul>
<b>Metal marks</b>	<ul style="list-style-type: none"> <li>• Scraping of metal utensils on cooktop surface. Do not slide metal utensils on cooktop surface. Use a ceramic-glass cooktop cleaning creme to remove the marks. See <b>Cleaning the Glass/Ceramic Cooktop</b> in the MAINTENANCE section, page 42-43 in the User's Guide.</li> </ul>
<b>Brown streaks or specks</b>	<ul style="list-style-type: none"> <li>• Boilovers are cooked onto surface. Use the blade scraper to remove soil. See <b>Cleaning the Glass/Ceramic Cooktop</b> in the MAINTENANC section, page 42-43 in the User's Guide.</li> </ul>
<b>Areas of discoloration with metallic sheen</b>	<ul style="list-style-type: none"> <li>• Mineral deposits from water and food. Remove using a ceramic-glass cooktop cleaning creme. Use cookware with clean, dry bottoms.</li> </ul>
<b>Oven will not self clean</b>	<ul style="list-style-type: none"> <li>• The oven temperature is too high to set a self clean operation.                             <ul style="list-style-type: none"> <li>- Allow the range to cool and reset the controls.</li> </ul> </li> <li>• Oven controls improperly set.                             <ul style="list-style-type: none"> <li>- See the self clean section, page38-40 in the User's Guide.</li> </ul> </li> <li>• A self clean cycle cannot be started if the oven lockout feature is active.</li> </ul>
<b>“Crackling” or “popping” sound</b>	<ul style="list-style-type: none"> <li>• This is the sound of the metal heating and cooling during both the cooking and Self Clean functions.                             <ul style="list-style-type: none"> <li>- This is normal.</li> </ul> </li> </ul>
<b>Fan noise</b>	<ul style="list-style-type: none"> <li>• A convection fan may automatically turn on and off.                             <ul style="list-style-type: none"> <li>- This is normal.</li> </ul> </li> </ul>
<b>Oven racks are difficult to slide</b>	<ul style="list-style-type: none"> <li>• Apply a small amount of vegetable oil to a paper towel and wipe the edges of the ovenracks with the paper towel.</li> </ul>
<b>Convection Fan stops</b>	<ul style="list-style-type: none"> <li>• Convection fan stops during a convection bake cycle.                             <ul style="list-style-type: none"> <li>- This is normal and is done to allow for more even heating during the cycle. This is not a failure of the range and should be considered normal operation.</li> </ul> </li> </ul>



# SCHEMATIC DIAGRAM

## ⚠ WARNING

POWER MUST BE DISCONNECTED BEFORE SERVICING THE APPLIANCE. FAILURE TO DO SO CAN RESULT IN DEATH OR ELECTRICAL SHOCK.

## NOTE:

Schematic diagram shows oven door opened and unlocked. All elements are set to "OFF".

## ※ RADIANT COOK-TOP

Wattage	Ω
RR: 1200W	approx. 48Ω
LR: 1200W	approx. 48Ω
LF: 3000W	approx. 19Ω
- 1400W(inner)	approx. 41Ω
- 1600W(outer)	approx. 36Ω
RF: 3000W	approx. 19Ω
- 1100W(inner)	approx. 52Ω
- 1100W(middle)	approx. 52Ω
- 800W(outer)	approx. 72Ω
CR: 100W	approx. 570Ω

## WIRE COLORS

SYMBOL	COLOR
BK	BLACK
RD	RED
WH	WHITE
BN	BROWN
PK	PINK
YL	YELLOW
BL	BLUE
GY	GRAY
GN	GREEN
OR	ORANGE
VI	VIOLET

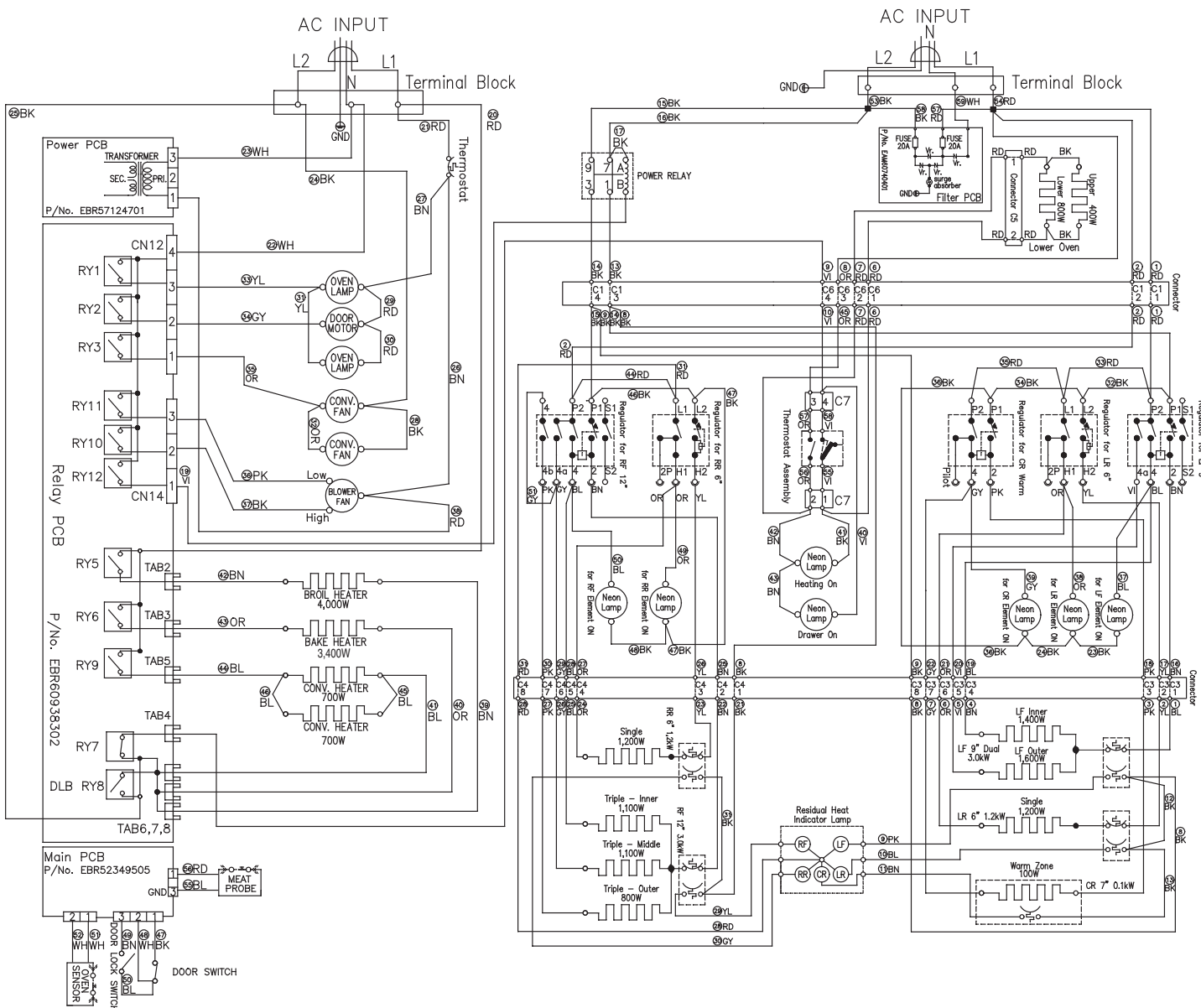

# STRIP CIRCUITS

Complete the following steps before checking electric oven circuit :

1. Check the line voltage, household fuse or circuit breaker.
2. Check for loose wiring or mis-wiring within electric range.

**NOTE:** The following individual circuits are for use in diagnosis, and are shown in the ON position.

**For Model: LSE3092ST**

**CONV. BAKE / CONV. ROAST**

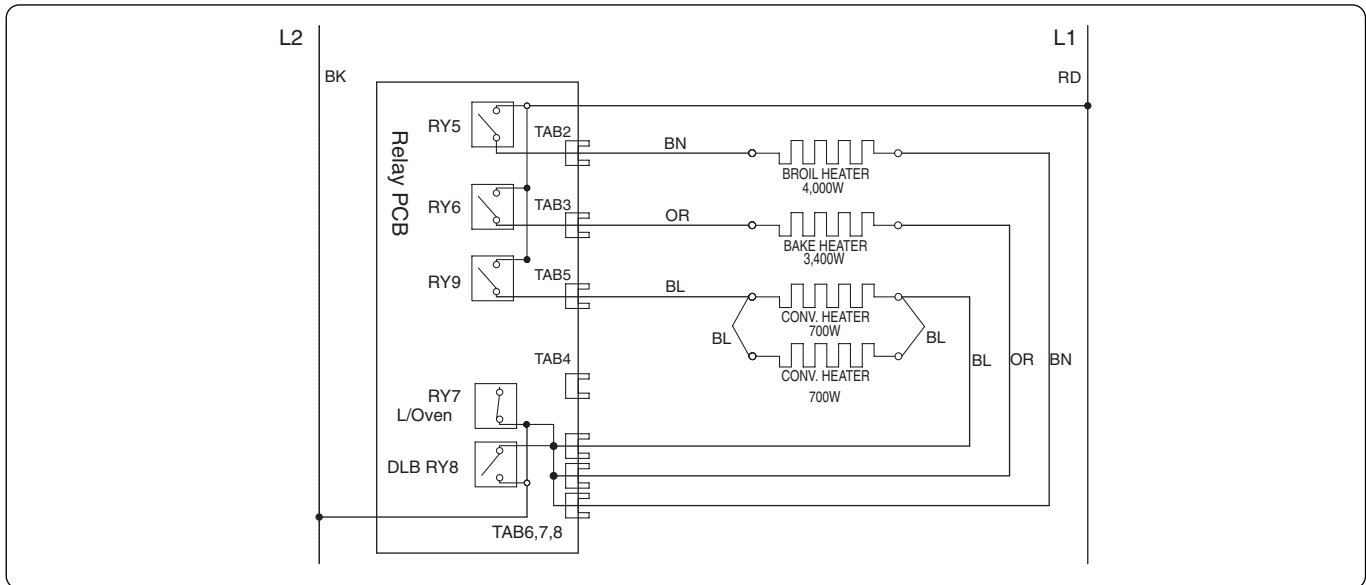

## SELF CLEANING

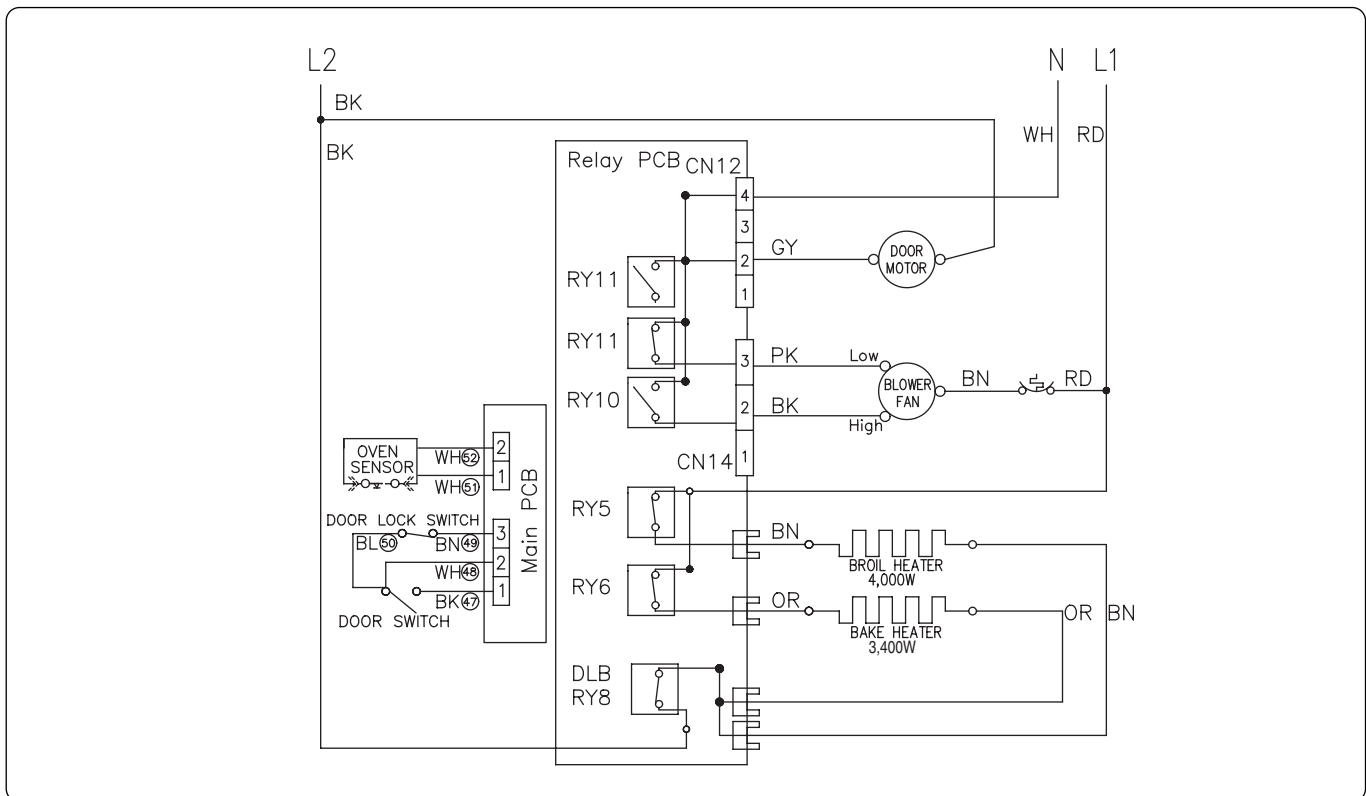

# For Model: LSE3092ST

## OVEN LIGHT

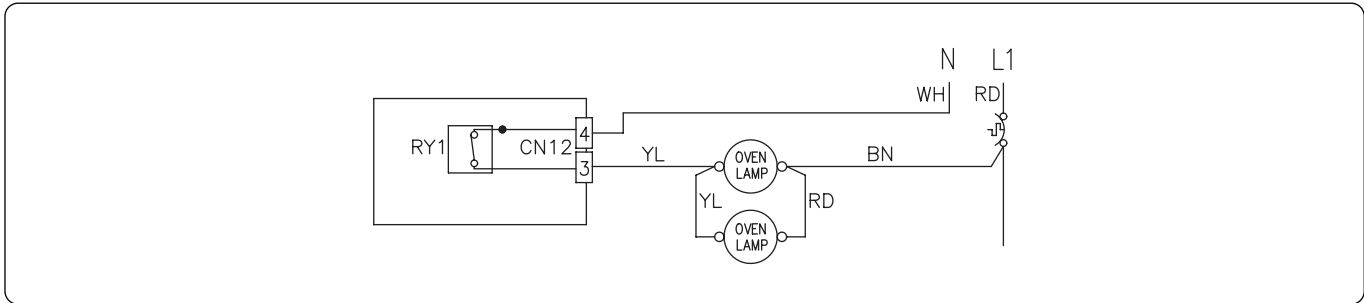

## LOWER OVEN DRAWER

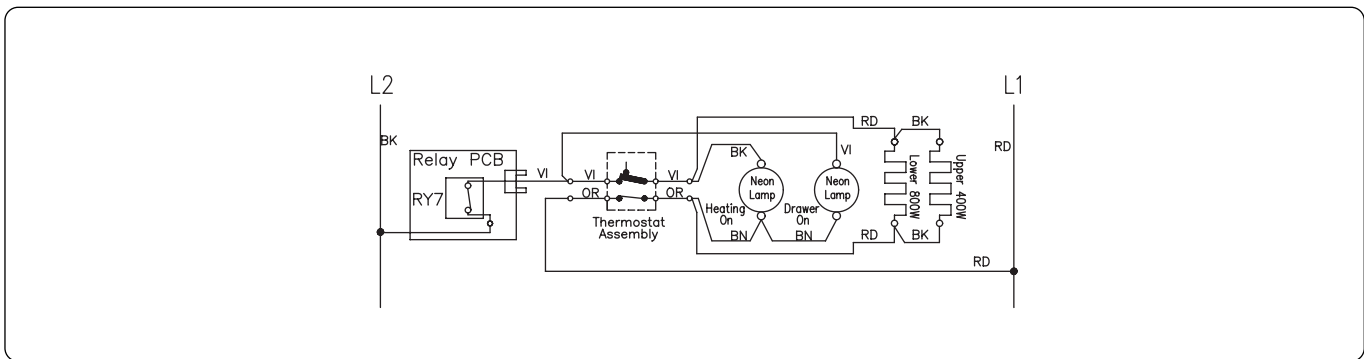

## CR (Warming Zone)

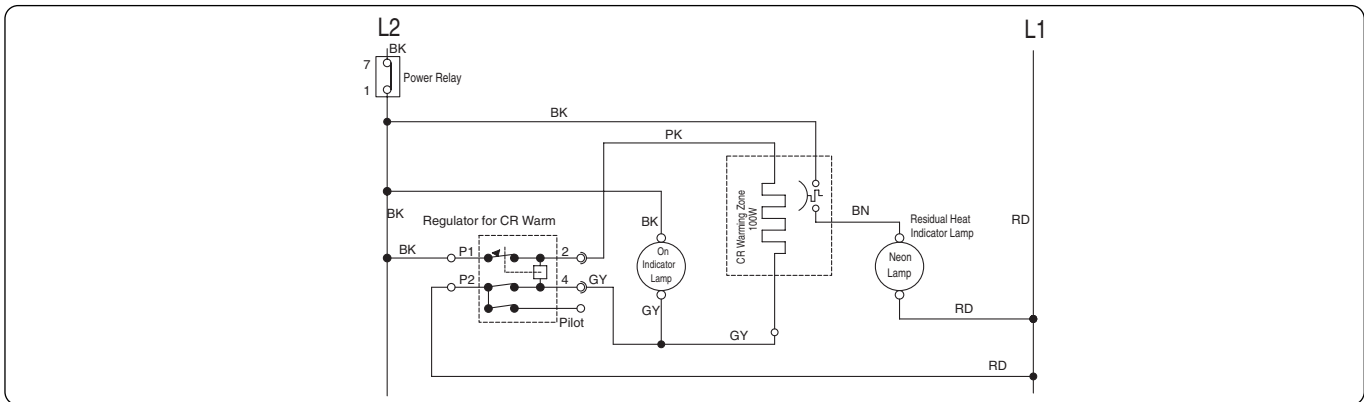

## RR Cook-top Element

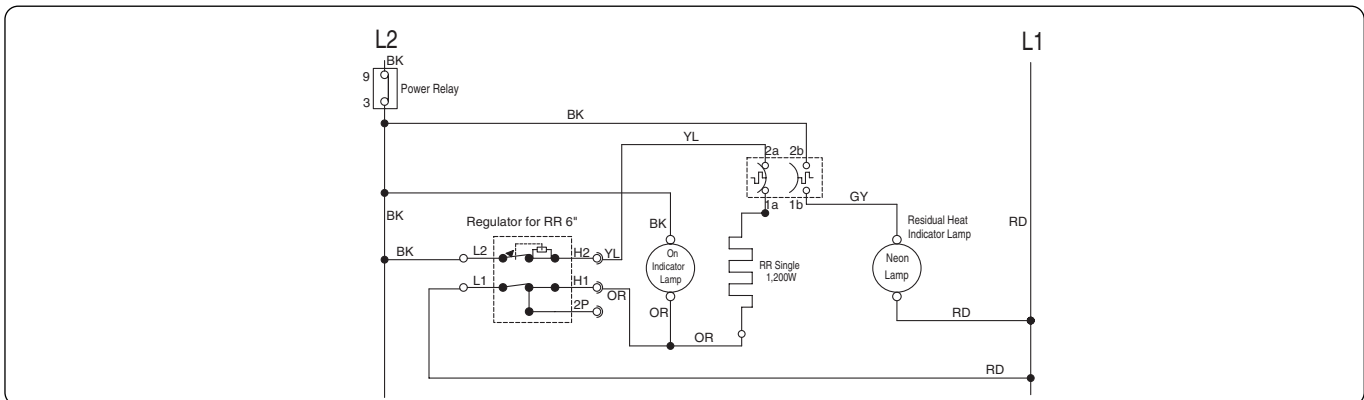

# For Model: LSE3092ST

## LR Cook-top Element

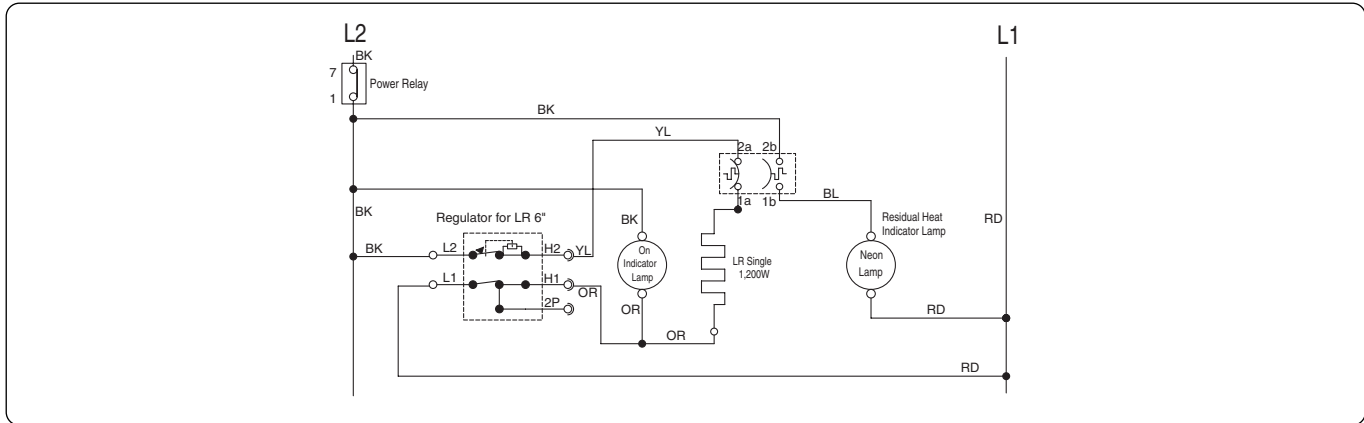

## LF Cook-top Element

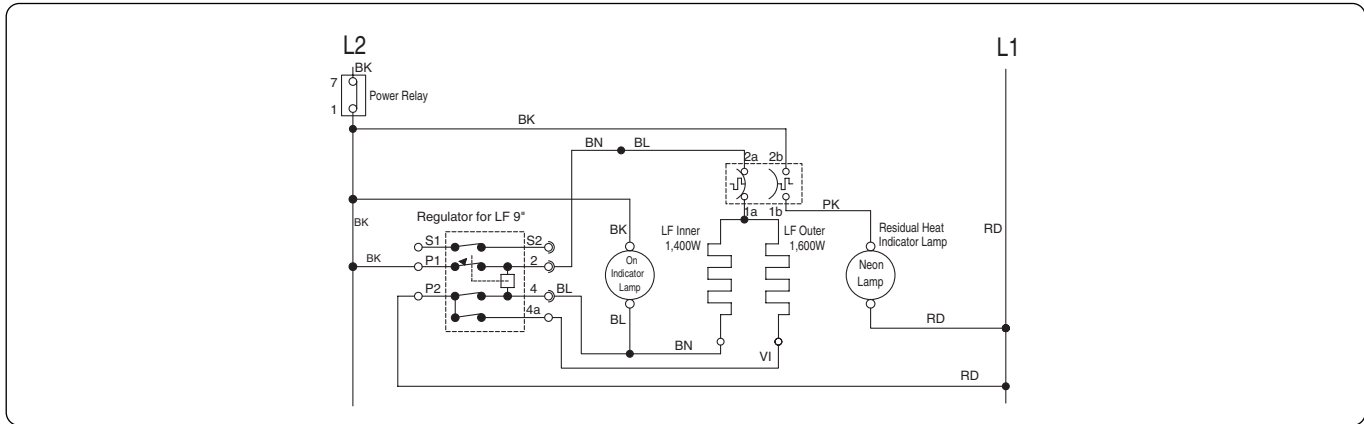

## RF Cook-top Element

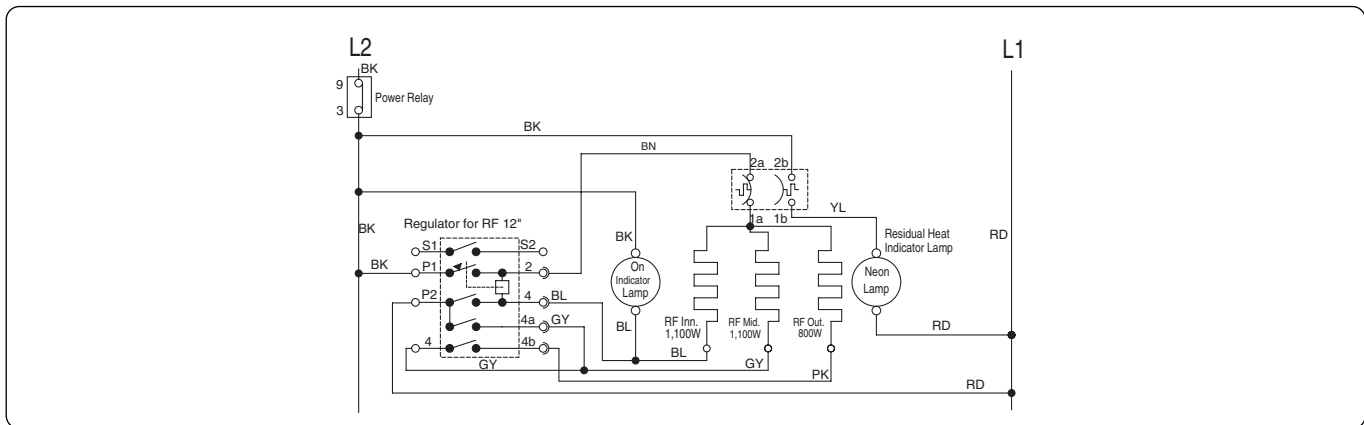

# EXPLODED VIEW

## INTRODUCTION

MODEL: LSE3092ST

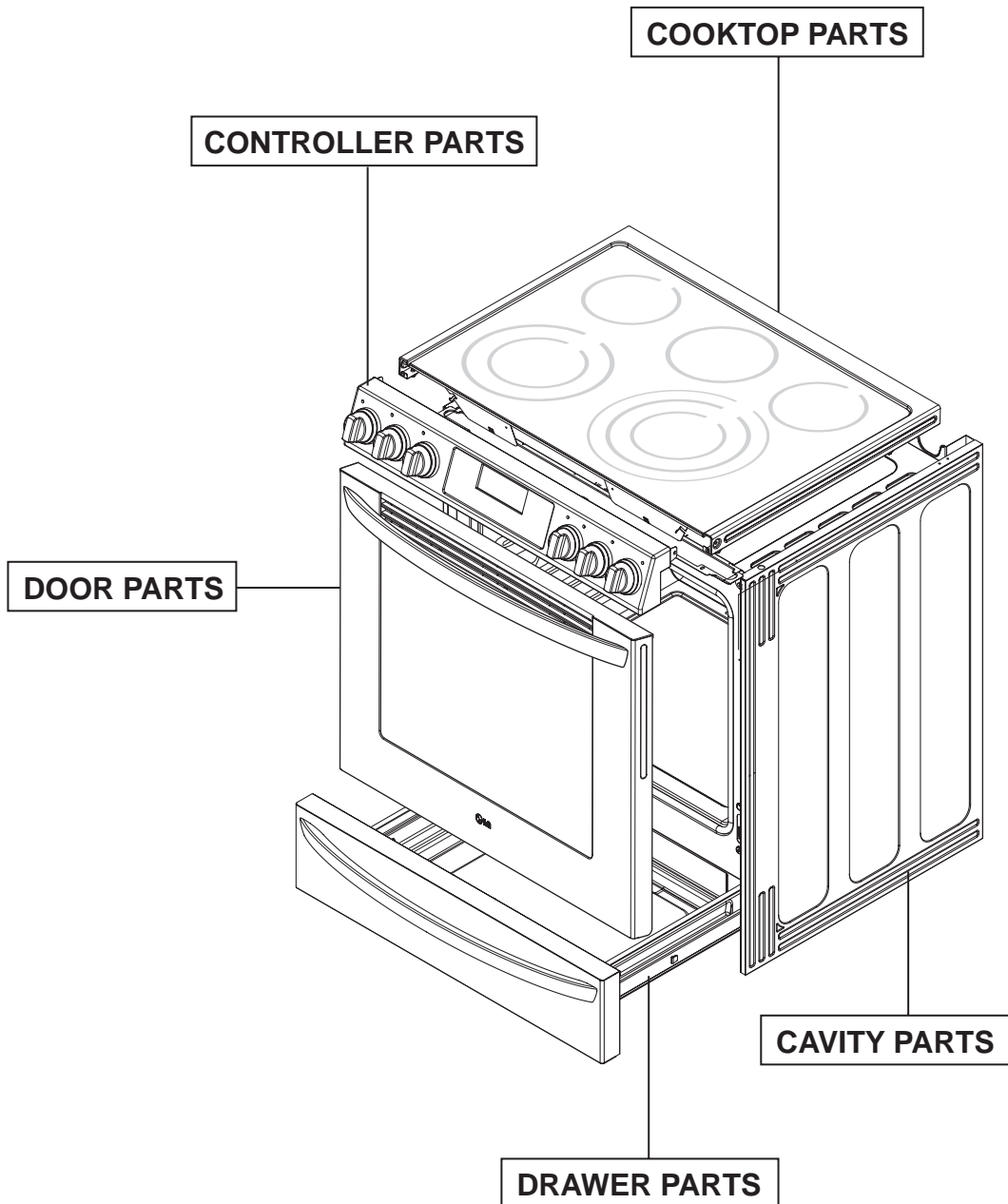







# COOKTOP PARTS

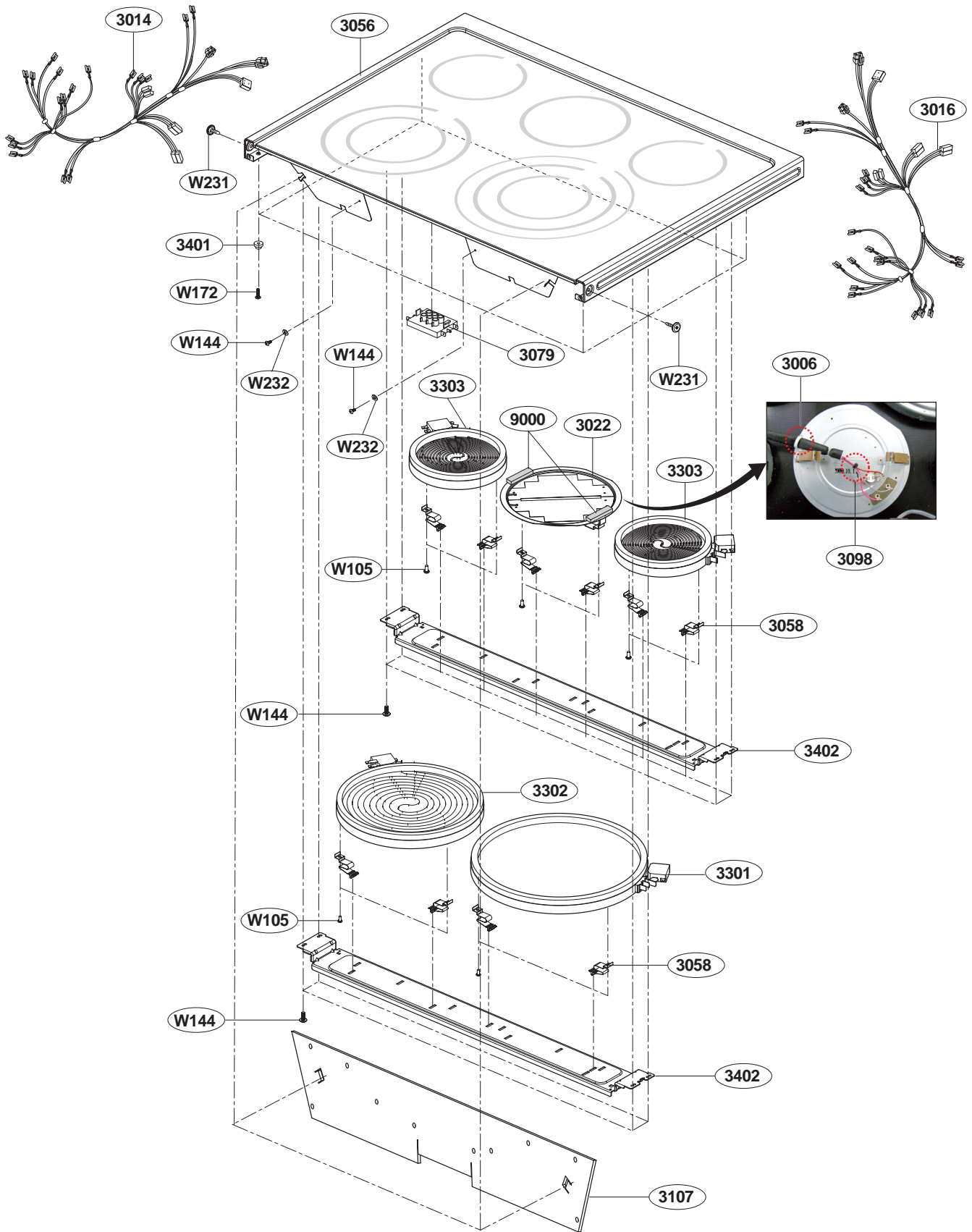

# DRAWER PARTS

