

This Owner's Manual is provided and hosted by [Appliance Factory Parts](#).

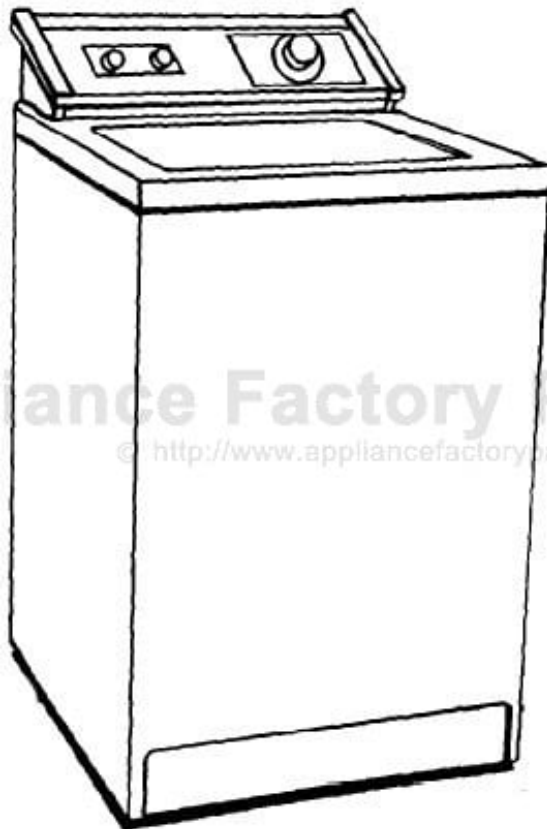

WHIRLPOOL IL45000 Owner's Manual

[Shop genuine replacement parts for WHIRLPOOL
IL45000](#)



[Find Your WHIRLPOOL Washer Parts - Select From 4132 Models](#)

----- Manual continues below -----

Installation

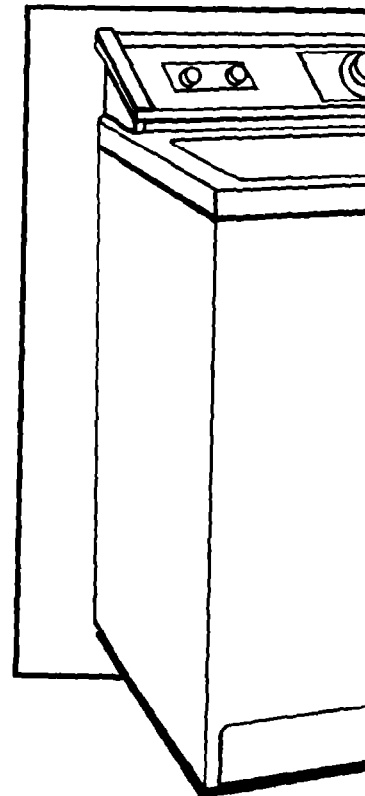

IMPORTANT
Read and save
these instructions

IMPORTANT:

Installer: Leave Installation Instructions with the homeowner.

Homeowner: Keep Installation Instructions for future reference.

Save Installation Instructions for electrical inspector's use.

Before you start...

Check location where washer will be installed. Proper installation is your responsibility. Make sure you have everything necessary for correct installation.

Grounded electrical outlet is required. See Electrical requirements.

Standpipe drain system: needs 5 cm (2") minimum diameter standpipe with minimum carry-away capacity of 65 liters (14 Imperial gallons) per minute. Top of standpipe must be at least 87 cm (34") high and no higher than 183 cm (72") from bottom of washer. **Do not tape hose into standpipe or close the standpipe completely. An air path is required to prevent siphoning.**

Floor drain system: Requires a siphon break, Part No. 285320, available from authorized distributors.

Untape and open washer lid. Remove all material from washer.

Hot and be within of the wa pressure

Laundry a 75 liter laundry least 87 higher th bottom o

If a lo a drain and h 2854- autho additi muse (Part

Water (140°F)



Do Not store below 32°F remain in w See Use & "Winterizing Failure to fo in product

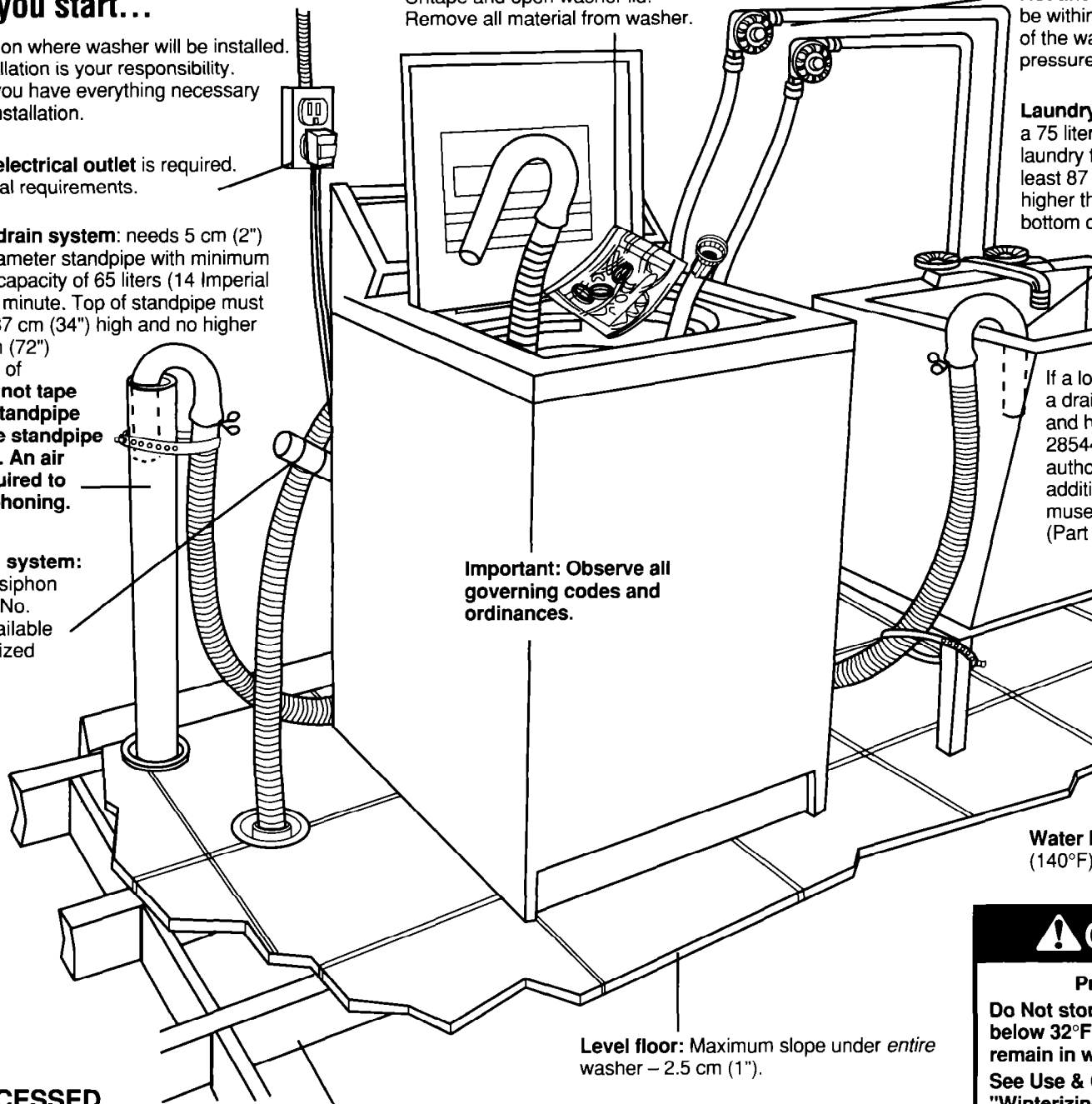

Important: Observe all governing codes and ordinances.

Level floor: Maximum slope under *entire* washer – 2.5 cm (1").

Support: Floor must be sturdy enough to support washer weight of 143 kilograms (315 lb).

SEE RECESSED AREA INSTRUCTIONS ON PANEL A.

Tools needed for installation:



Electrical requirements

120-volt, 60-Hz, AC-only, 15 or 20 ampere fused electrical supply is required. (Time-delay fuse or circuit breaker is recommended.) It is recommended that a separate circuit serving only this appliance be provided.

Grounding method

⚠ WARNING
Electrical Shock Hazard
 • Electrical ground is required on

Recommended grounding

For your personal must be grounded equipped with a p having a 3-prong g minimize possible cord must be plug 3-prong grounding grounded in acco appropriate Cana and local codes ar mating wall recept is the obligation of a properly ground receptacle install

Now start...
With washer in laundry area.

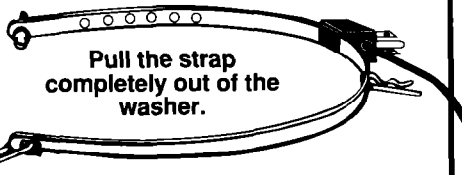
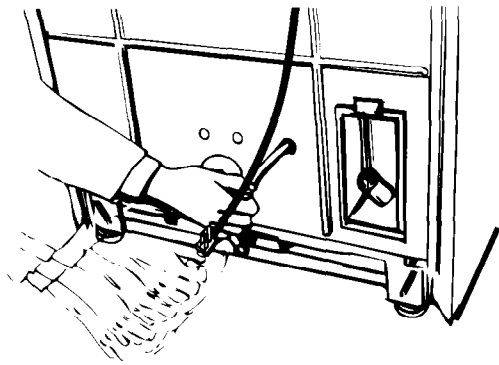

Pull the strap completely out of the washer.

1. Read, then remove label that covers yellow shipping strap and power supply cord. Pull to completely remove the shipping strap with 2 cotterpins from the inside of the washer. The power cord is attached to the shipping strap.

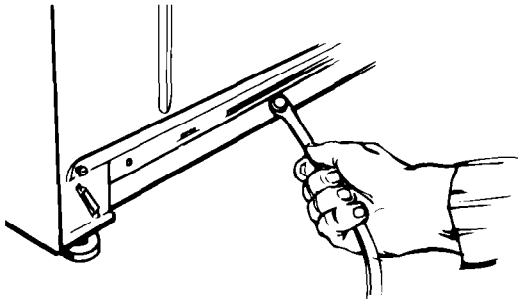

Pull firmly to remove the other end of the shipping strap from the back of the washer. The shipping strap plug must be completely removed from the washer for the self-leveling legs to be released.

Save the shipping strap for use in Step 16.

Use new hoses and washers that came with your washer.

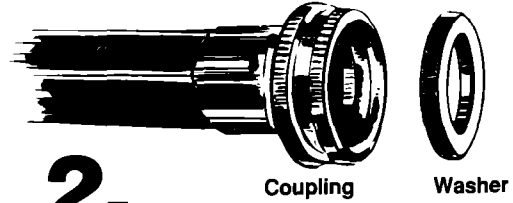

2.

Insert a flat washer into **each** end of the inlet hoses. Check that washers are firmly seated in couplings.

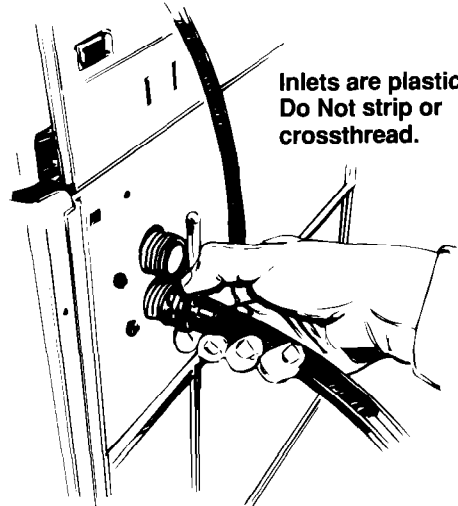

Inlets are plastic. Do Not strip or crossthread.

3.

Attach hose to bottom inlet valve opening first; then attach second hose to top inlet. Tighten couplings by hand. Then use pliers to make an additional two-thirds turn.

IMPORT
FOLLOW
INSTALL

0-0.64
(0-1/4)

4.

1. We
- tap
- LUI
2. Squ
- ope
- the
3. Wh
- dra
- dra
- ribb
4. Wh
- 0.6
- clar
- of t
- enc

Literature rack not supplied with all models.

Numbers correspond to steps.

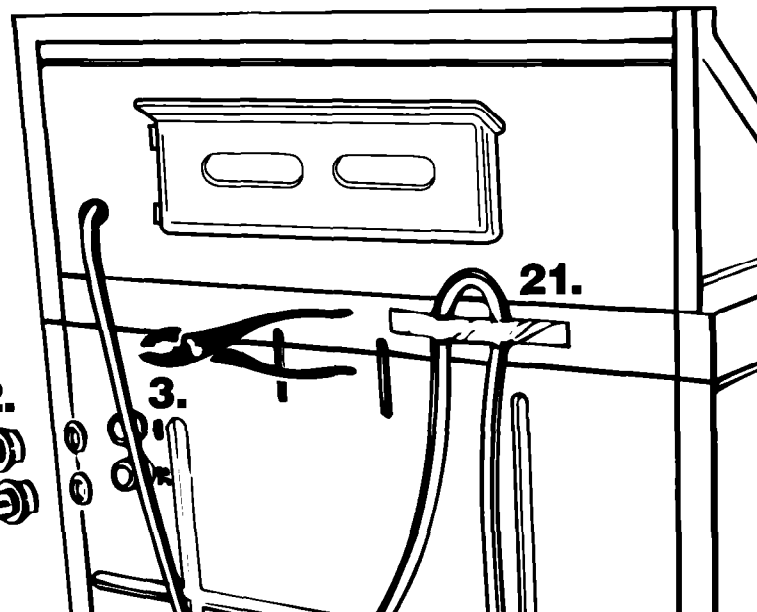
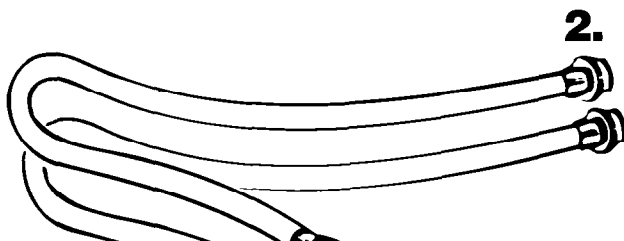

5. Open clamp and slide over "hook" end of drain hose to secure the rigid and corrugated sections together.

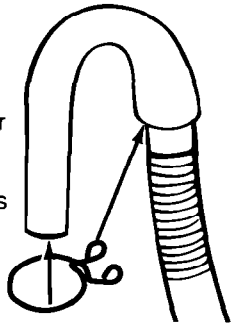

! CAUTION

Floor Damage
Slide washer onto cardboard or hardboard before moving across floor.
Failure to do so may cause damage to floor covering.

6. Move washer close to final position. Put "hook" end of drain hose into laundry tub or standpipe. Check for proper length of drain hose.

DO NOT FORCE EXCESS LENGTH OF DRAIN HOSE DOWN THE STANDPIPE. THIS COULD CAUSE SIPHONING.



7. Before attaching water inlet hose, run water through both faucets into a bucket. This will get rid of particles in the water lines that might clog hoses. Mark which is the hot water faucet.

8. Attach bottom hose (inlet marked "H") to hot water faucet. Attach top hose (inlet marked "C") to cold water faucet. Tighten couplings to faucets by hand, then use pliers to make final two-thirds turn.

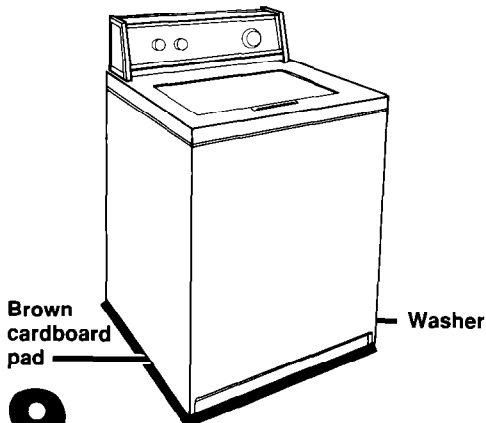

9. Read before removing brown cardboard pad (not supplied with all models).

- Tilt washer back on rear feet.
- Pull brown cardboard pad down and

12.

Insert legs into correct holes at each front corner of washer until nuts touch washer. Do not tighten nuts until Step 15.

13.

Tilt washer backward and remove wood block. Gently lower washer to floor.

Move washer to its final location.

Remove cardboard or hardboard from under washer.

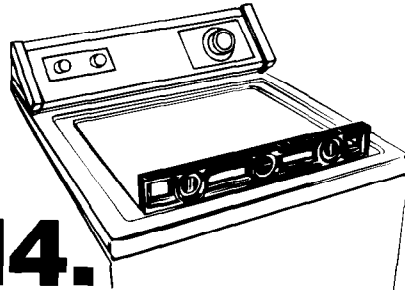

14.

Tilt washer forward, raising back legs 2.5 cm (1") off of floor to adjust rear self-leveling legs. Gently lower washer to floor. Check levelness at the washer front and from front to back on each side, using a carpenter's level.

15.

If washer is not level, adjust the front legs up or down. Make final check with level.

When washer is level, use wrench to turn nuts on front legs up tightly against washer base. If nuts are not tight against washer base, the washer may vibrate.

! CAUTION

Property Damage
Secure the drain hose to the tub or standpipe with the shipping strap removed from the back of the washer.
Failure to properly secure drain hose could result in water damage.

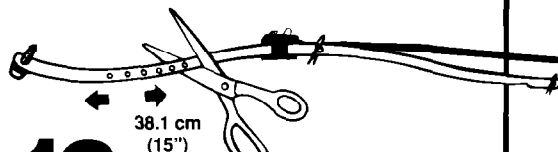

D
If drain hose is not in correct place, it must be secured to the "hook" end of the tub or standpipe.

If a longer drain hose (Part No. 2) is used, an extension kit (Part No. 2) is available from the retailer. If drain hose is not used, an extension kit (Part No. 2) is available from the retailer.

Note: If washer is not level, the washer will vibrate. Repeat the leveling process carefully to avoid damaging floor covering.

17.

CHECK ELECTRICAL CONNECTIONS. BE SURE YOU FOLLOW THE ELECTRICAL RECOMMENDATIONS IN THE USER MANUAL.

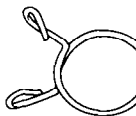

18.

Check that all connections are correct. See parts list for details. If a part is missing, go back to the retailer where the washer was purchased.

19.

Turn on water supply. Tighten coupling nuts. Do not overtighten. Not overtighten.

20.

Check that you have the shipping plug in the correct place. The shipping plug was removed from the back of the washer.

Recessed area instructions.

This washer may be installed in a recessed area or closet.

The installation spacing is the minimum allowable. Additional spacing should be considered for ease of installation and servicing.

If closet door is installed, the minimum air openings in top and bottom are required. Louvered doors with air openings in top and bottom are acceptable.

Companion appliance spacing should be considered.

If you need assistance...

Call your dealer or local authorized service company. When you call, you will need the model number and serial number. Both numbers can be found on the serial/rating plate located under the washer lid and on the top of the washer.

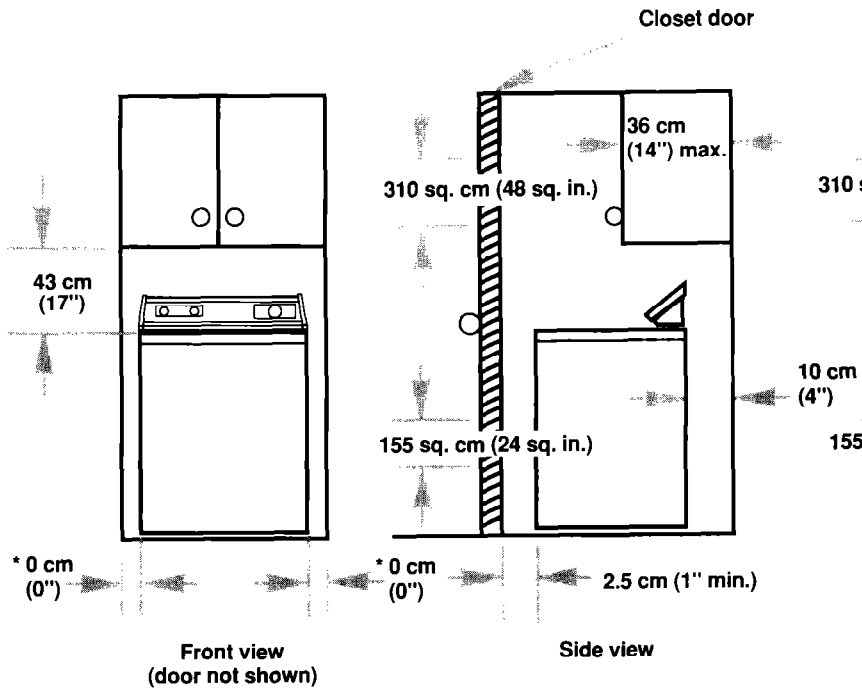

* Additional clearances for wall, door and floor moldings may be required.

Minimum installation spacing

PANEL A