

This Owner's Manual is provided and hosted by [Appliance Factory Parts](#).

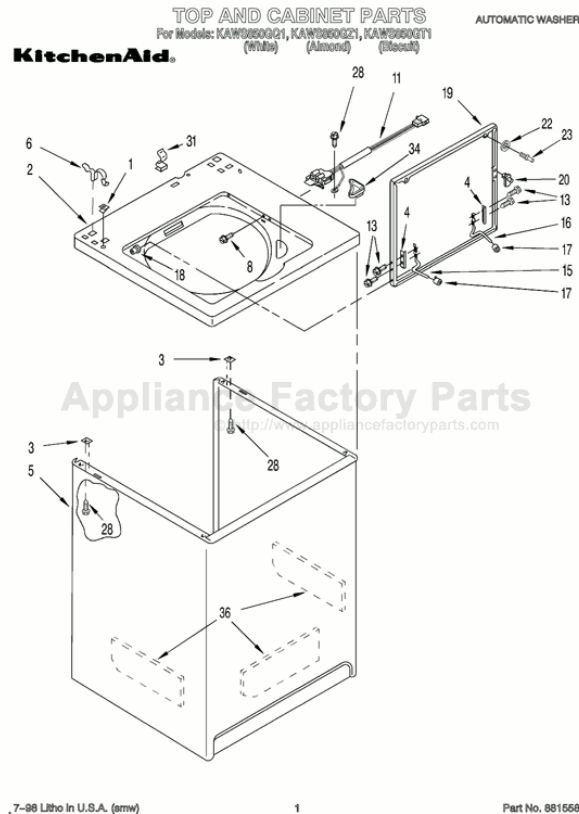

# WHIRLPOOL KAWS850GT1 Owner's Manual

[Shop genuine replacement parts for WHIRLPOOL  
KAWS850GT1](#)



[Find Your WHIRLPOOL Washer Parts - Select From 4132 Models](#)

----- Manual continues below -----

**KitchenAid®**

---

# AUTOMATIC WASHER

## Use & Care Guide

For questions about features, operation/performance, parts, accessories or service, call: **1-800-422-1230**  
In Canada, call for assistance **1-800-461-5681**, for installation and service, call: **1-800-807-6777**  
or visit our website at [www.kitchenaid.com](http://www.kitchenaid.com) or [www.kitchenaid.com/canada](http://www.kitchenaid.com/canada)

---

Table of Contents.....2

---



Models KAWS700G, KAWS750G, KAWS800G, KAWS850G  
3950451C

---

# TABLE OF CONTENTS

<b>WASHER SAFETY</b> .....	<b>3</b>
<b>PARTS AND FEATURES</b> .....	<b>4</b>
<b>USING YOUR WASHER</b> .....	<b>5</b>
Understanding Washer Cycles .....	5
Loading.....	5
Normal Washer Sounds .....	5
Starting Your Washer .....	6
Selecting a Cycle and Time .....	7
SENSORSURE™ Temperature Control .....	9
Rinse and Spin .....	9
Drain and Spin.....	9
Self-Cleaning Lint Filter.....	9
<b>CARING FOR YOUR WASHER</b> .....	<b>10</b>
Cleaning Your Washer .....	10
Water Inlet Hoses.....	10
Vacation, Storage, and Moving Care.....	10
<b>TROUBLESHOOTING</b> .....	<b>11</b>
<b>ASSISTANCE OR SERVICE</b> .....	<b>14</b>
In the U.S.A. ....	14
In Canada .....	14
<b>WARRANTY</b> .....	<b>15</b>

# WASHER SAFETY

## Your safety and the safety of others are very important.

We have provided many important safety messages in this manual and on your appliance. Always read and obey all safety messages.



This is the safety alert symbol.

This symbol alerts you to potential hazards that can kill or hurt you and others.

All safety messages will follow the safety alert symbol and either the word "DANGER" or "WARNING." These words mean:

**! DANGER**

**You can be killed or seriously injured if you don't immediately follow instructions.**

**! WARNING**

**You can be killed or seriously injured if you don't follow instructions.**

All safety messages will tell you what the potential hazard is, tell you how to reduce the chance of injury, and tell you what can happen if the instructions are not followed.

## IMPORTANT SAFETY INSTRUCTIONS

**WARNING:** To reduce the risk of fire, electric shock, or injury to persons when using the washer, follow basic precautions, including the following:

- Read all instructions before using the washer.
- Do not wash articles that have been previously cleaned in, washed in, soaked in, or spotted with gasoline, dry-cleaning solvents, other flammable, or explosive substances as they give off vapors that could ignite or explode.
- Do not add gasoline, dry-cleaning solvents, or other flammable, or explosive substances to the wash water. These substances give off vapors that could ignite or explode.
- Under certain conditions, hydrogen gas may be produced in a hot water system that has not been used for 2 weeks or more. HYDROGEN GAS IS EXPLOSIVE. If the hot water system has not been used for such a period, before using the washing machine, turn on all hot water faucets and let the water flow from each for several minutes. This will release any accumulated hydrogen gas. As the gas is flammable, do not smoke or use an open flame during this time.
- Do not allow children to play on or in the washer. Close supervision of children is necessary when the washer is used near children.
- Before the washer is removed from service or discarded, remove the lid.
- Do not reach into the washer if the tub or agitator is moving.
- Do not install or store the washer where it will be exposed to the weather.
- Do not tamper with controls.
- Do not repair or replace any part of the washer or attempt any servicing unless specifically recommended in this Use and Care Guide or in published user-repair instructions that you understand and have the skills to carry out.
- See Installation Instructions for grounding requirements.

**SAVE THESE INSTRUCTIONS**

# PARTS AND FEATURES

This manual covers several different models. The washer you have purchased may have some or all of the parts and features listed below.

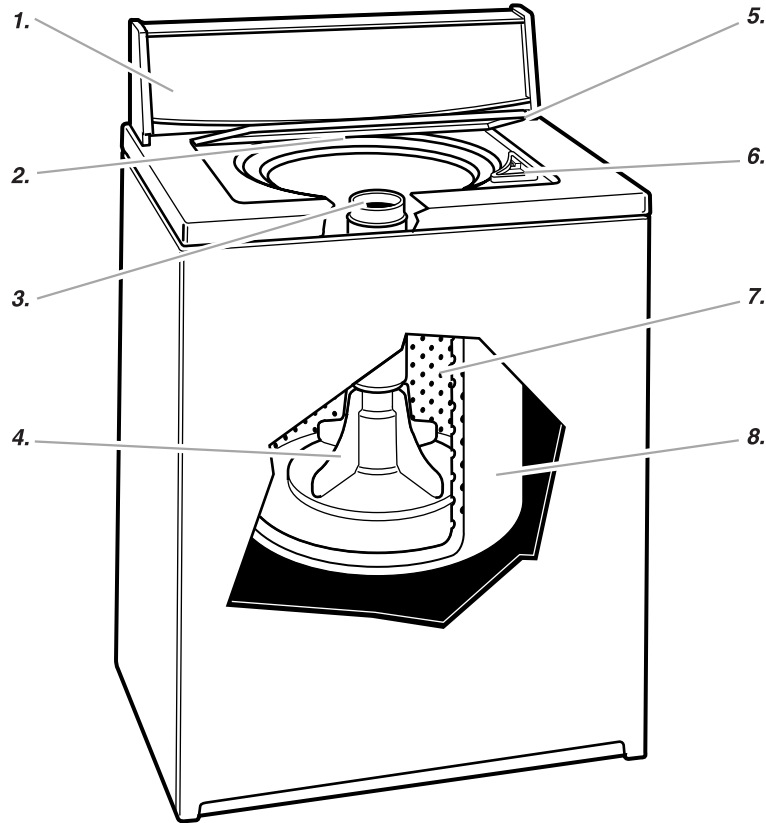

- 1. Control panel
- 2. Model and serial number label
- 3. Liquid fabric softener dispenser
- 4. SURE CARE® agitator
- 5. Lid
- 6. Liquid chlorine bleach dispenser

- 7. Basket
- 8. Tub
- 9. Self-cleaning lint filter
- 10. White porcelain basket

**Other feature your washer may have**  
SENSORSURE™ temperature control

## Control panel

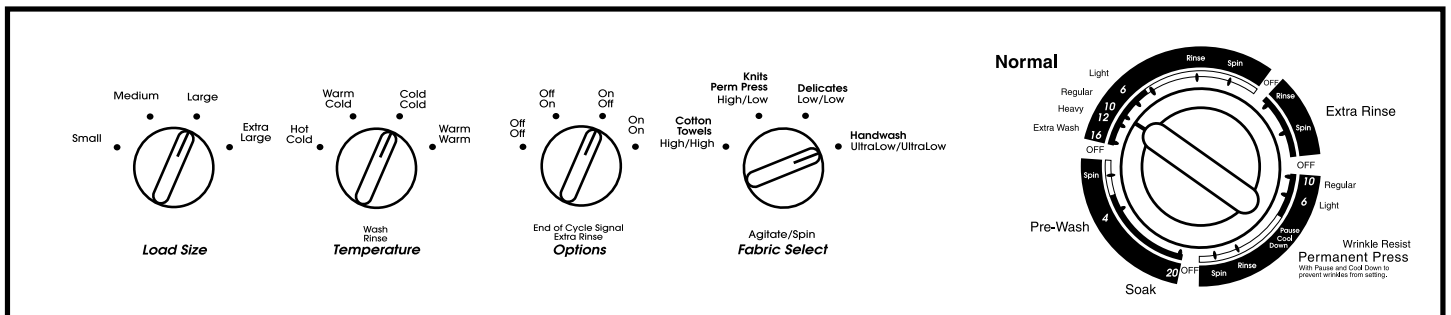

# USING YOUR WASHER

## Understanding Washer Cycles





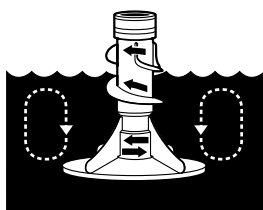





When the Cycle Control knob is set to a number and pulled out, the washer fills (to the selected load size) before agitation and timing start. The washer begins agitating immediately after filling; agitation occurs with the washer lid up or down.

During agitation, the agitator creates a continuous rollover action that provides a thorough cleaning of the wash load.



After agitation starts, the Cycle Control knob turns clockwise until it points to an OFF area and the cycle ends.

**NOTE:** The washer pauses briefly throughout each cycle. These pauses are normal for washer operation.

WASH	RINSE
 1. Fill	 1. Fill
 2. Wash selected time	 2. Rinse
 3. Drain No agitation	 3. Drain No agitation
 4. Spin	 4. Spin-Spray rinse
	 5. Spin
† The Permanent Press cycle partially drains, fills, agitates briefly, and drains.	 6. Off

## Loading

### Loading suggestions

For these suggested full-sized loads, set the LOAD SIZE selector to the highest load size setting.

### SUPER CAPACITY PLUS WASHERS

#### Heavy Work Clothes

3 pair pants	1 coverall
3 shirts	1 overall
4 pair jeans	

#### Delicates

3 camisoles	2 bras
1 quilted robe	2 nighties
4 slips	1 baby's dress
4 panties	

#### Towels

10 bath towels	14 wash cloths
10 hand towels	1 bath mat

#### Mixed Load

3 double sheets	2 shirts
4 pillowcases	2 blouses
8 T-shirts	8 handkerchiefs
6 pair shorts	

## Normal Washer Sounds

Your new washer may make sounds your old one didn't. Because the sounds might be unfamiliar, you may be concerned about them. These sounds are normal.

### During washing

When you select a small load size setting, your washer has a lower water level. This can cause a clicking sound from the upper part of the agitator.

### During drain

If water is drained quickly from your washer (depending on your installation), you may hear air being pulled through the pump during the end of draining.

### After drain and before spin

When the cycle changes from draining to spinning, you may hear gears engaging.

# Starting Your Washer

## ⚠ WARNING



### Fire Hazard

Never place items in the washer that are dampened with gasoline or other flammable fluids.

No washer can completely remove oil.

Do not dry anything that has ever had any type of oil on it (including cooking oils).

Doing so can result in death, explosion, or fire.

## ⚠ WARNING



### Electrical Shock Hazard

Plug into a grounded 3 prong outlet.

Do not remove ground prong.

Do not use an adapter.

Do not use an extension cord.

Failure to follow these instructions can result in death, fire, or electrical shock.

1. Measure detergent and pour it into the washer. If desired, add powdered or liquid color safe bleach. Add extra detergent for the Extra Wash cycle.



Drop a sorted load of clothes loosely into your washer.

- Load evenly to maintain washer balance. Mix large and small items.
- Items should move easily through the wash water. Overloading can cause poor cleaning.

- To reduce wrinkling of permanent press clothes and some synthetic knits, use a large load size to provide more space (see step 5).

2. (OPTIONAL STEP) Pour measured **liquid chlorine bleach** into the liquid chlorine bleach dispenser. Bleach will be diluted automatically during the wash part of the cycle.

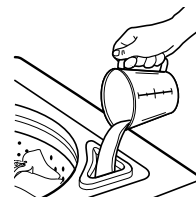

- Never use more than 1 cup (250 mL) for a full load. Use less with a smaller load size.
- Follow the manufacturer's directions for safe use.
- To avoid spilling, use a cup with a pouring spout. Do not let bleach splash, drip, or run down into the washer basket.
- Use only liquid chlorine bleach in this dispenser.

3. (OPTIONAL STEP) Pour measured **liquid fabric softener** into the liquid fabric softener dispenser. Softener is added automatically during the rinse portion of the cycle.

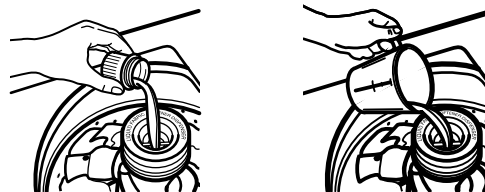

Dilute liquid fabric softener by filling the dispenser with warm water until liquid reaches the crossbar in the opening.

- Do not spill or drip any fabric softener on the clothes.
- Use only liquid fabric softener in this dispenser.

4. Close the washer lid.
5. Turn the **LOAD SIZE** selector to the correct setting for your wash load and the type of fabric being washed.
  - Choose a load size that allows the load to move freely for best fabric care. See "Loading."
  - To change the load size selection after the washer has started filling, turn the selector to the desired setting. On models with a Reset option, first move the selector to RESET, then to the new load size.
6. Turn the **TEMPERATURE** selector to the correct setting for the type of fabric and soils being washed. Use the warmest water safe for fabric. Follow garment label instructions.

Water Temp	Use For
<b>Hot</b> 111°F (44°C) or above	Whites and pastels Heavy and greasy soils
<b>Warm</b> 90°-110°F (32°-43°C)	Bright colors Moderate to light soils
<b>Cold</b> 70°-90°F (21°-32°C)	Colors that bleed or fade Light soils

**NOTE:** In wash water temperatures colder than 70°F (21°C), detergents do not dissolve well. Soils can be difficult to remove. Some fabrics can retain wear wrinkles and have increased pilling (the formation of small lint-like balls on the surface of garments).

- Some models have an electronic sensor control that maintains a uniform water temperature. See "SENSORSURE™ Temperature Control."
- 7. (OPTIONAL STEP) Some models have an EXTRA RINSE selector. For an additional rinse and spin at the end of the Normal wash cycle, set the selector to On.
- 8. (OPTIONAL STEP) Some models have an OPTIONS selector. This allows you to select an End of Cycle Signal at the end of any cycle and/or add an Extra Rinse to your Normal wash cycle only.
  - The End of Cycle Signal is helpful when you are washing items that should be removed from the washer as soon as the cycle ends.
  - An Extra Rinse removes additional detergent residue from heavily soiled or special care items.

#### Using the OPTIONS selector

- Set the selector at On/On for an End of Cycle Signal and an Extra Rinse.
  - Set the selector at On/Off for an End of Cycle Signal only.
  - Set the selector at Off/On for an Extra Rinse only.
  - Set the selector at Off/Off if you do not desire an End of Cycle Signal or an Extra Rinse.
9. Push in the Cycle Control knob and turn it clockwise to the wash cycle you want. Reduce wash time when using a small load size setting. See "Selecting a Cycle and Time."

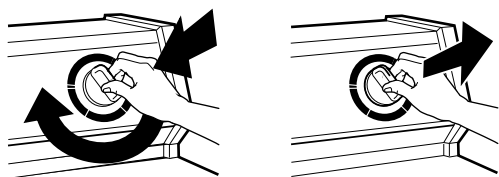

Pull out the Cycle Control knob to start the washer.

To stop or start your washer

- To **stop** the washer at any time, push in the Cycle Control knob.
- To **restart** the washer, close the lid (if open) and pull out the Cycle Control knob.

## Selecting a Cycle and Time

This section describes the available wash cycles and will help you make the best cycle selections for your wash loads. Each cycle is designed for different types of fabric and soil levels.

- The washer pauses briefly throughout each cycle. These pauses are normal. Refer to "Normal Washer Sounds" to learn more about the sounds you may hear during a wash cycle.
- Refer to "Understanding Washer Cycles" to learn what happens during a wash cycle.

**NOTE:** This manual covers several different models. The Cycle Control knob for each model is shown below. Once you find your model number, use the cycle descriptions for that particular washer.

### Model KAWS700G

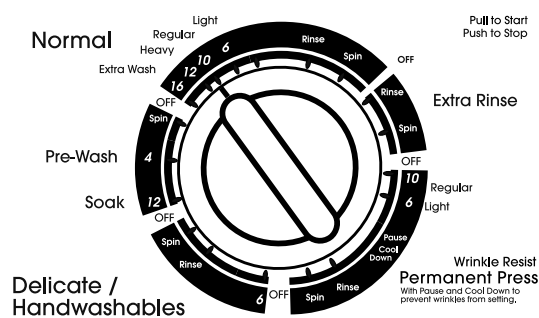

Cycle control knob

#### Normal cycle

The Normal cycle features extended agitation time for cleaning cottons and linens, and longer spin times to shorten drying time. Select 6, 10, or 12 minutes of wash time, depending on whether your load is lightly, moderately or heavily soiled.

**Extra Wash** - Select the 16-minute Extra Wash feature to wash heavily soiled loads that need maximum soil removal. Use two times the amount of recommended detergent for this cycle.

#### Wrinkle Resist/Permanent Press cycle

The Wrinkle Resist/Permanent Press cycle starts with high agitation and then steps to low for cleaning permanent press blends and synthetic fabrics. To maximize water removal but minimize wrinkling, this cycle features a cool-down rinse and a final spin that steps through extra low, low and high spin. Select 6 or 10 minutes of wash time for lightly to moderately soiled loads.

## Delicate cycle

The 6-minute Delicate cycle can be used to gently clean delicate items and washable knits. This cycle offers low agitation and spin speeds.

### To use this cycle

1. Turn the Cycle Control knob to Delicate/Handwashables.
2. Set the HANDWASH selector to Off.

## Handwashables cycle

The 6-minute Handwashables cycle features brief periods of low speed agitation and soak time. Low spin speed reduces wrinkling. Use this cycle for cleaning lightly soiled hand washables.

### To use this cycle

1. Turn the Cycle Control knob to Delicate/Handwashables.
2. Set the HANDWASH selector to On.

## Soak cycle

The Soak cycle features brief periods of agitation and soak time to help remove heavy soils and stains that need pre-treatment.

- Use warm water when soaking laundry. Hot water can set some stains.
- Use the amount of detergent or presoak additive recommended by the manufacturer.
- The Soak cycle automatically advances into the Pre-Wash cycle.

## Pre-Wash cycle

The Pre-Wash cycle features 4 minutes of agitation to help remove heavy soils and stains that need pre-treatment. When the Pre-Wash period ends, add detergent and start a new wash cycle.

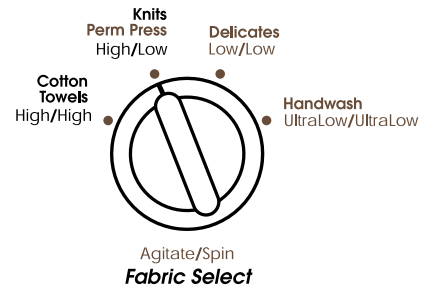

## Normal cycle

The Normal cycle is used with the Fabric Select option to provide the best wash and spin action for a given load. Select 6, 10 or 12 minutes of wash time depending on whether your load is lightly, moderately or heavily soiled.

**Extra Wash** – Select the 16-minute Extra Wash feature to wash heavily soiled loads that need maximum soil removal. Use two times the amount of recommended detergent for this cycle.

## Wrinkle Resist/Permanent Press cycle

The Wrinkle Resist/Permanent Press cycle is used with the Fabric Select option to provide the best wash and spin action for a given load. The Wrinkle Resist/Permanent Press cycle features a pause and cool down rinse to reduce wrinkling. Use 6 or 10 minutes of wash time for lightly to moderately soiled loads.

## Soak cycle

The Soak cycle features brief periods of agitation and soak time to help remove heavy soils and stains that need pretreatment.

- Use warm water when soaking laundry. Hot water can set stains.
- Use the amount of detergent or presoak additive recommended by the manufacturer.
- The Soak cycle automatically advances into the Pre-Wash cycle.

## Pre-Wash cycle

The Pre-Wash cycle features 4 minutes of agitation to help remove heavy soils and stains that need pre-treatment. When the Pre-Wash period ends, add detergent and start a new wash cycle.

## Additional Fabric Select options available on the KAWS850G model

### Sweaters option

Use this option to gently clean non-wool sweaters.

### To use this option

1. Turn the FABRIC SELECT option to Sweaters.
2. Set the TEMPERATURE selector to the SENSORSURE™ Cold/Cold setting.
3. Set the Cycle Control knob to a 6-minute Normal wash cycle.

## Models KAWS750G, KAWS800G, KAWS850G

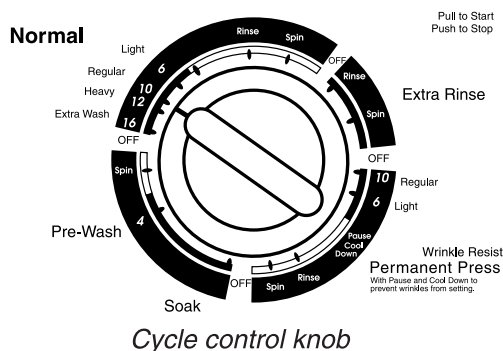

## Handwash/Wool option

Use this option to gently clean washable wool garments (refer to your garment's care label).

### To use this option

1. Turn the FABRIC SELECT option to Handwash/Wool.
2. Set the TEMPERATURE selector to the SENSORSURE™ Cold/Cold setting.
3. Set the Cycle Control knob to a 6-minute Normal wash cycle.

---

## SENSORSURE™ Temperature Control

SENSORSURE temperature control electronically senses and maintains a uniform water temperature by regulating incoming hot and cold water.

SENSORSURE keeps warm and cold water temperatures within recommended ranges for best detergent performance and fabric care.

- Cold wash is regulated at approximately 75°F (24°C).
- Warm wash is regulated at approximately 100°F (38°C).

### To select SENSORSURE

Turn the TEMPERATURE selector to a SENSORSURE setting.

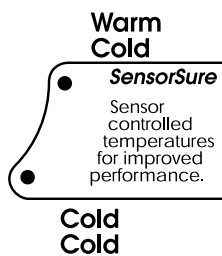

---

## Rinse and Spin

When using extra detergent for heavily soiled clothes, or washing special-care items, you may find an extra rinse and spin is needed.

1. Push in the Cycle Control knob and turn it clockwise to any of the Rinse settings.
2. Pull out the Cycle Control knob. The washer fills to the selected load size, agitates, drains, and spins.

**NOTE:** An EXTRA RINSE option is available (on some models). See "Starting Your Washer."

---

## Drain and Spin

A drain and spin may help shorten drying times for some heavy fabrics or special-care items by removing excess water.

1. Push in the Cycle Control knob and turn it clockwise to any of the Spin settings.
2. Pull out the Cycle Control knob. The washer drains, then spins.

---

## Self-Cleaning Lint Filter

Your washer has a self-cleaning lint filter at the bottom of the basket. Wash and rinse water flow over the filter during agitation, separating the lint from the water. The lint spins out of the system during the spin part of the cycle.

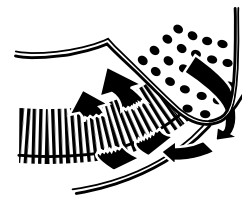

If your washer drains into a tub, remove any lint collected in the tub or strainer.

---

# CARING FOR YOUR WASHER

---

## Cleaning Your Washer

### Cleaning the exterior

Use a soft, damp cloth or sponge to wipe up any spills such as detergent or bleach. Occasionally wipe the outside of your washer to keep it looking new.

### Cleaning the interior

Clean your washer interior by mixing 1 cup (250 mL) of chlorine bleach and 2 cups (500 mL) of detergent. Pour this into your washer and run it through a complete cycle using hot water. Repeat this process if necessary.

**NOTE:** Remove any hard water deposits using only cleaners labeled as washer safe.

### Cleaning the liquid fabric softener dispenser

Flush dispenser periodically with warm water, as shown. Remove the dispenser by grasping the top of the dispenser with both hands and squeezing and pushing upwards with thumbs. Clean the dispenser by rinsing it under a water faucet. Replace it after cleaning.

**NOTE:** Do not wash clothes with this dispenser removed. Do not add detergent or bleach to this dispenser; it is for liquid fabric softener use only.

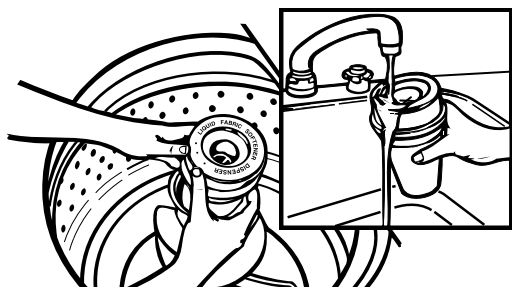

---

## Water Inlet Hoses

Replace inlet hoses after five years of use to reduce the risk of hose failure. Periodically inspect and replace inlet hoses if bulges, kinks, cuts, wear or leaks are found.

When replacing your inlet hoses, mark the date of replacement on the label with a permanent marker.

---

## Vacation, Storage, and Moving Care

Install and store your washer where it will not freeze. Because some water may stay in the hoses, freezing can damage your washer. If storing or moving your washer during freezing weather, winterize it.

### Non-use or vacation care

Operate your washer only when you are at home. If you will be on vacation or not using your washer for an extended period of time, you should:

- Unplug washer or disconnect power.
- Turn off the water supply to the washer. This helps avoid accidental flooding (due to a water pressure surge) while you are away.

### To winterize washer

1. Shut off both water faucets.
2. Disconnect and drain water inlet hoses.
3. Put 1 quart (1 L) of R.V.-type antifreeze in the basket.
4. Run washer on a drain and spin setting (see "Drain and spin") for about 30 seconds to mix the antifreeze and water.
5. Unplug washer or disconnect power.

### To use washer again

1. Flush water pipes and hoses.
2. Reconnect water inlet hoses.
3. Turn on both water faucets.
4. Plug in washer or reconnect power.
5. Run the washer through a complete cycle with 1 cup (250 mL) of detergent to clean out antifreeze.

---

# TROUBLE-SHOOTING

**First try the solutions suggested here and possibly avoid the cost of a service call...**

---

## Washer won't fill, rinse or agitate

---

- **Check the following:**
  - Is the power cord plugged in?
  - Is the indicator on the Cycle Control knob properly lined up with a cycle? Turn the Cycle Control knob to the right slightly and **pull to start**.
  - Are the water inlet valve screens clogged?
  - Are both the hot and cold water faucets turned on?
  - Is the water inlet hose kinked?
- **Does the water level seem too low, or the washer appears to not fill completely?**

The top of the agitator is much higher than the highest water level. This creates a perception that the washer is not filling completely. This is normal.

---

## Washer stops

---

- **Check the following:**
  - Is the power cord plugged in?
  - Is the indicator on the Cycle Control knob properly lined up with a cycle? Turn the Cycle Control knob to the right slightly and **pull to start**.
  - Are the water inlet valve screens clogged?
  - Are both the hot and cold water faucets turned on?
  - Is the water inlet hose kinked?
- **Is there power at the plug?**

Check your electrical source or call an electrician.
- **Has a fuse blown or is the circuit breaker open?**

If problem continues, call an electrician.
- **Are you using an extension cord?**

Do not use an extension cord.
- **Is the washer in a normal pause in the Permanent Press (or Hand Washables) cycle?**

The washer pauses for about 2 minutes in the Permanent Press cycle. Allow the cycle to continue.

The Hand Washables cycle (on some models) features periods of agitation and soak.
- **Is the washer overloaded?**

Wash smaller loads.

---

## Washer won't drain or spin

---

- **Is the drain hose clogged, or the end of the drain hose more than 72 inches (183 cm) above the floor?**

See the Installation Instructions for proper installation of drain hose.
- **Is the lid open?**

The lid must be closed during operation.
- **Is there excessive sudsing?**

Always measure detergent. Follow manufacturer's directions. If you have very soft water, you might need to use less detergent.
- **Is your voltage low?**

Check your electrical source or call an electrician. Do not use an extension cord.

---

## Washer continues to fill or drain, or the cycle seems stuck

---

- **Is the top of drain hose lower than the water level in washer?**

The top of the hose must be higher than the water level in the washer for proper operation. See the Installation Instructions.
- **Does the drain hose fit too tightly in the standpipe, or is it taped to the standpipe?**

The drain hose should be loose yet fit securely. Do not seal the drain hose with tape. The hose needs an air gap. See the Installation Instructions.

---

## Washer makes noise

---

- **Is the load balanced and the washer level?**

The wash load should be balanced and not overloaded.

The washer must be level. The front feet should be properly installed and the nuts tightened. Reset the rear leveling legs (if needed). See the Installation Instructions.
- **Did you completely remove the yellow shipping strap with cotter pins?**

See the Installation Instructions.
- **Are the gears engaging after the drain and before spin, or is the upper part of agitator clicking during wash?**

These are normal washer noises.

---

## Washer leaks

---

- **Check the following:**  
Are the fill hoses tight? Are the fill hose washers properly seated? Is the drain hose clamp properly installed? See the Installation Instructions.
- **Is the sink or drain clogged?**  
Sink and standpipe must be able to handle 17 gallons (64 L) of water per minute.
- **Is water deflecting off the tub ring or the load?**  
Center the tub before starting the washer.  
  
The wash load should be balanced and not overloaded. The fill or spray rinses can deflect off the load.  
  
The washer must be level. The front feet should be properly installed and the nuts tightened. Reset the rear leveling legs (if needed). See the Installation Instructions.
- **Check household plumbing for leaks.**

---

## Washer basket is crooked

---

- **Was the washer basket pulled forward during loading?**  
The wash load should be balanced and not overloaded. Push the basket to the center before starting wash.
- **Is the load balanced and the washer level?**  
The wash load should be balanced and not overloaded.  
  
The washer must be level. The front feet should be properly installed and the nuts tightened. Reset the rear leveling legs (if needed). See the Installation Instructions.
- **The washer basket moves while washing.**  
This is normal.

---

## Agitator operation

---

- **The top of the agitator is loose, or moves in only one direction.**  
This is normal.

---

## Dispensers clogged or bleach leaking

---

- **Did you follow the manufacturer's directions when adding detergent and fabric softener to the dispensers?**  
Measure detergent and fabric softener. Carefully pour into the dispensers. Wipe up all spills.  
  
Dilute fabric softener in the fabric softener dispenser.
- **Did you put powdered or color-safe bleach in the liquid chlorine bleach dispenser?**  
Add powdered or liquid color-safe bleach directly to the basket. Do not use the chlorine bleach dispenser for color-safe bleach.

---

## Load too wet

---

- **Did you use the right cycle for the load being washed?**  
Select a cycle with a higher spin speed (if available).
- **Did you use a cold rinse?**  
Cold rinses leave loads wetter than warm rinses. This is normal.

---

## Residue or lint on load

---

- **Did you sort properly?**  
Sort lint givers (towels, chenille) from lint takers (corduroy, synthetics). Also sort by color.
- **Did you overload the washer?**  
The wash load must be balanced and not overloaded. Lint can be trapped in the load if overloaded. Wash smaller loads.
- **Check the following:**  
Was paper or tissue left in the pockets?  
  
Did you use enough detergent? Follow manufacturer's directions. Use enough detergent to hold the lint in the water.  
  
Is your water colder than 70°F (21°C)? Wash water colder than 70°F (21°C) may not completely dissolve the detergent.

---

## Stains on load

---

- **Did you follow the manufacturer's directions when adding detergent and fabric softener?**  
Measure detergent and fabric softener. Use enough detergent to remove soil and hold it in suspension.  
  
Dilute fabric softener and add to the rinse portion of a cycle only. Do not drip fabric softener on clothes.
- **Is there above average iron (rust) in water?**  
You may need to install an iron filter.
- **Did you properly sort the load?**  
Sort dark clothes from whites and lights.
- **Did you unload the washer promptly?**  
To avoid dye transfer, unload the washer as soon as it stops.

---

## Load is wrinkled

---

- **Did you unload the washer promptly?**  
Unload the washer as soon as it stops.
- **Did you use the right cycle for the load being washed?**  
Use the Permanent Press cycle or another cycle with low spin speeds (if available) to reduce wrinkling.
- **Did you overload the washer?**  
The wash load must be balanced and not overloaded. Loads should move freely during washing.
- **Was the wash water warm enough to relax wrinkles, or are you using warm rinses?**  
If safe for the load, use warm or hot wash water. Use cold rinse water.
- **Are the hot and cold water hoses reversed?**  
Check to be sure the hot and cold water hoses are connected to the right faucets. See the Installation Instructions.

---

## Load is tangled or twisted

---

- **Did you overload the washer?**  
The wash load must be balanced and not overloaded. Loads should move freely during washing.
- **Did you wrap items around the agitator?**  
Drop items loosely into the washer. Do not wrap items around the agitator.

---

## Gray whites, dingy colors

---

- **Did you properly sort the load?**  
Dye transfer can occur when mixing whites and colors in a load. Sort dark clothes from whites and lights.
- **Was the wash temperature too low?**  
Use hot or warm washes if safe for the load. Hot water should be at least 111°F (44°C) to clean heavy or greasy soils.
- **Did you use enough detergent, or do you have hard water?**  
Use more detergent for washing heavy soils in cold or hard water.
- **Are the hot and cold water hoses reversed?**  
Check to be sure the hot and cold water hoses are connected to the right faucets. See the Installation Instructions.

---

## Garment damage

---

- **Check the following:**  
Were sharp items removed from pockets before washing? Empty pockets, zip zippers, snap or hook fasteners before washing.  
  
Were strings and sashes tied to prevent tangling?  
  
Were items damaged before washing? Mend rips and broken threads in seams before washing.
- **Did you overload the washer?**  
The wash load must be balanced and not overloaded. Loads should move freely during washing.
- **Did you properly add chlorine bleach?**  
Do not pour chlorine bleach directly on load. Wipe up bleach spills. Undiluted bleach will damage fabrics.
- **Did you follow the manufacturer's care label instructions?**

---

# ASSISTANCE OR SERVICE

Before calling for assistance or service, please check "Troubleshooting." It may save you the cost of a service call. If you still need help, follow the instructions below.

When calling, please know the purchase date and the complete model and serial number of your appliance. This information will help us to better respond to your request.

## If you need replacement parts

If you need to order replacement parts, we recommend that you only use factory specified parts. These parts will fit right and work right, because they are made with the same precision used to build every new KITCHENAID® appliance. To locate factory specified replacement parts in your area, call our Consumer Assistance Center telephone number or your nearest designated service center.

---

## In the U.S.A.

Call the KitchenAid Consumer Assistance Center toll free: **1-800-422-1230**.

### Our consultants provide assistance with:

- Features and specifications on our full line of appliances.
- Installation information.
- Use and maintenance procedures.
- Accessory and repair parts sales.
- Specialized customer assistance (Spanish speaking, hearing impaired, limited vision, etc.).
- Referrals to local dealers, repair parts distributors, and service companies. KitchenAid designated service technicians are trained to fulfill the product warranty and provide after-warranty service, anywhere in the United States.

To locate the KitchenAid designated service company in your area, you can also look in your telephone directory Yellow Pages.

### For further assistance

If you need further assistance, you can write to KitchenAid with any questions or concerns at:

KitchenAid Brand Home Appliances  
Consumer Assistance Center  
c/o Correspondence Dept.  
2000 North M-63  
Benton Harbor, MI 49022-2692

Please include a daytime phone number in your correspondence.

---

## In Canada

Call the KitchenAid Canada Consumer Assistance Center toll free: **1-800-461-5681** 8:30 a.m. - 6:00 p.m. (EST)

### Our consultants provide assistance with:

- Features and specifications on our full line of appliances.
- Referrals to local dealers.

### For service in Canada

Call **1-800-807-6777**. KitchenAid designated service technicians are trained to fulfill the product warranty and provide after-warranty service, anywhere in Canada.

### For further assistance

If you need further assistance, you can write to KitchenAid Canada with any questions or concerns at:

Consumer Relations Center  
KitchenAid Canada  
1901 Minnesota Court  
Mississauga, Ontario L5N 3A7

Please include a daytime phone number in your correspondence.

---

# KITCHENAID® WASHER WARRANTY

---

## TWO-YEAR FULL WARRANTY

For two years from the date of purchase, when this washer is operated and maintained according to instructions attached to or furnished with the product, KITCHENAID will pay for replacement parts and repair labor to correct defects in materials or workmanship. Service must be provided by a KITCHENAID designated service company.

---

## THIRD THROUGH FIFTH YEAR LIMITED WARRANTY

For the third through fifth year from the date of purchase, when this washer is operated and maintained according to instructions attached to or furnished with the product, KITCHENAID will pay for replacement parts for the motor and center post assembly bearings if defective in materials or workmanship.

---

## THIRD THROUGH TENTH YEAR LIMITED WARRANTY

For the third through tenth year from the date of purchase, when this washer is operated and maintained according to instructions attached to or furnished with the product, KITCHENAID will pay for replacement parts for the following components if defective in materials or workmanship: the top/lid and cabinet assembly due to rust; any part of the gearcase assembly; the outer tub should it crack, or fail to contain water.

---

## LIFETIME LIMITED WARRANTY

For the lifetime of the washer, when this washer is operated and maintained according to instructions attached to or furnished with the product, KITCHENAID will pay for replacement parts for the white porcelain basket should it chip or rust due to defects in materials or workmanship.

---

### KitchenAid will not pay for:

1. Service calls to correct the installation of your washer, to instruct you how to use your washer, or to replace house fuses or correct house wiring or plumbing.
  2. Repairs when your washer is used in other than normal, single-family household use.
  3. Damage resulting from accident, alteration, misuse, abuse, fire, flood, acts of God, improper installation, or installation not in accordance with local electrical and plumbing codes.
  4. Any labor costs during the limited warranties.
  5. Replacement parts or repair labor costs for units operated outside the United States and Canada.
  6. Pickup and delivery. This product is designed to be repaired in the home.
  7. Repairs to parts or systems resulting from unauthorized modifications made to the appliance.
  8. In Canada, travel or transportation expenses for customers who reside in remote areas.
- 

### KITCHENAID AND KITCHENAID CANADA DO NOT ASSUME ANY RESPONSIBILITY FOR INCIDENTAL OR CONSEQUENTIAL DAMAGES.

Some states and provinces do not allow the exclusion or limitation of incidental or consequential damages, so this exclusion or limitation may not apply to you. This warranty gives you specific legal rights and you may also have other rights which vary from state to state or province to province.

Outside the 50 United States and Canada, this warranty does not apply. Contact your local KITCHENAID dealer to determine if another warranty applies.

If you need service, first see "Troubleshooting." Additional help can be found by checking "Assistance or Service," or by calling our Consumer Assistance Center at **1-800-422-1230**, from anywhere in the U.S.A. or write: KitchenAid Brand Home Appliances, Consumer Assistance Center, c/o Correspondence Dept., 2000 North M-63, Benton Harbor, MI 49022-2692. In Canada, call KitchenAid Canada at **1-800-807-6777**. 11/99

---

Keep this book and your sales slip together for future reference. You must provide proof of purchase or installation date for in-warranty service.

Write down the following information about your washer to better help you obtain assistance or service if you ever need it. You will need to know your complete model number and serial number. You can find this information on the model and serial number label/plate, located on your appliance as shown in "Parts and Features."

Dealer name \_\_\_\_\_

Address \_\_\_\_\_

Phone number \_\_\_\_\_

Model number \_\_\_\_\_

Serial number \_\_\_\_\_

Purchase date \_\_\_\_\_