

This Owner's Manual is provided and hosted by [Appliance Factory Parts](#).



Lynx L36PSR-1-2010 Owner's Manual

[Shop genuine replacement parts for Lynx
L36PSR-1-2010](#)



[Find Your Lynx Grill Parts - Select From 362 Models](#)

----- Manual continues below -----

SPECIFICATIONS

The guides, measurements and dimensions detailed below are designed to assist you with planning your outdoor kitchen. Please note: because of continuing product innovation, specifications are subject to change without notice.

Important: Please reference the Care & Use / Installation Manual for details on gas plumbing requirements, electrical specifications and the proper installation of your Lynx outdoor kitchen equipment. This manual can be downloaded from the Lynx website at www.lynxgrills.com



TRASH CENTER AND TOWEL DISPENSER

Trash Center Model No. L18TC

Cutout width and height indicated above; depth 13"

Trash Chute Model No. L18TS

Cutout width and depth indicated above; height 4"

Towel Dispenser Model No. L16TWL

Cutout width and height indicated above; depth 7¹/₂"

OUTDOOR REFRIGERATOR

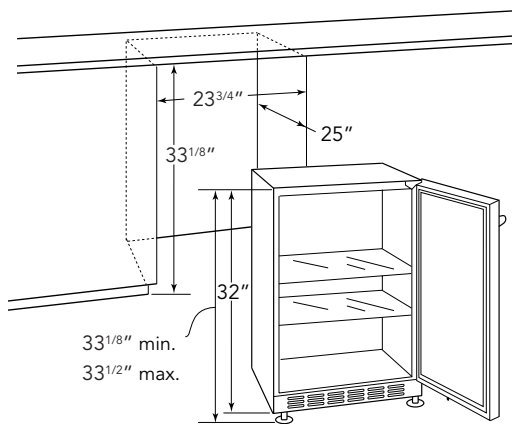

ICE MACHINE

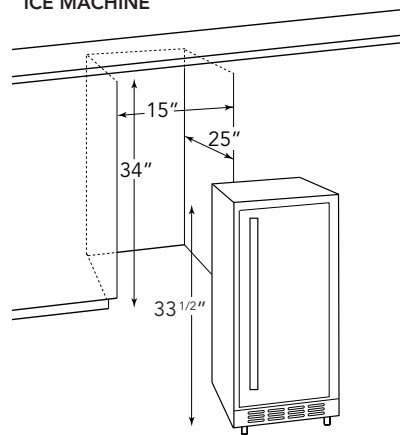

CLEARANCE

4" Minimum

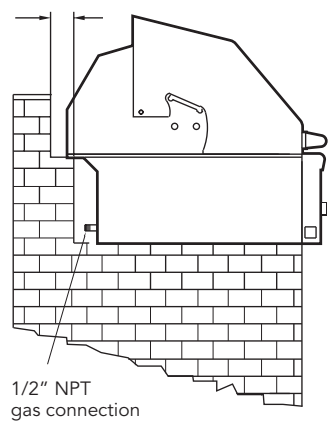

SPECIFICATIONS

PROFESSIONAL GRILLS

Model	A	B	C	D	E	F	G	H
L27	-	26	22	-	-	-	-	-
L30	-	29	24 ^{1/2}	-	-	-	-	-
L36	-	35	22	-	-	-	-	-
L42	-	41	24 ^{1/2}	-	-	-	-	-
L54	-	53	24 ^{1/2}	-	-	-	-	-

COMPLEMENTARY PRODUCTS

Model	A	B	C	D	E	F	G	H
ACCESS DOORS								
LDR21-1	-	-	-	19 ^{1/4}	-	-	-	-
LDR27-1	-	-	-	25 ^{1/4}	-	-	-	-
LDR30-1	-	-	-	28 ^{1/4}	-	-	-	-
LDR36-2	-	-	-	34 ^{1/4}	-	-	-	-
LDR42-1	-	-	-	40 ^{1/4}	-	-	-	-

SIDE BURNERS

LSB1	12 ^{1/8}	-	24 ^{1/2}	-	-	-	-	-
LSB2	12 ^{1/8}	-	24 ^{1/2}	-	-	-	-	-
LSB2PC	24 ^{1/4}	-	24 ^{1/2}	-	-	-	-	-
LPSGE	12 ^{1/8}	-	24 ^{1/2}	-	-	-	-	-
LPB	19	-	22	-	-	-	-	-

UTILITY DRAWERS

LUDE	-	-	24	-	12 ^{1/8}	19 ^{1/4}	-	-
LUDXL	-	-	24 ^{1/4}	-	17 ^{1/4}	18 ^{9/16}	-	-

WARMING DRAWERS

L30WD	-	-	20 ^{1/2}	-	-	-	28 ^{1/2}	10
L42CC	-	-	24 ^{1/2}	-	-	-	40 ^{1/4}	19 ^{3/8}

COCKTAIL PRO

CS30	-	-	22 ^{3/4}	-	-	-	-	-
------	---	---	-------------------	---	---	---	---	---

WITH INSULATED JACKET INSTALLED

Model	A	B	C	D	E	F
LJ27	33	5	24 ^{1/2}	4 ^{1/2}	3	11 ^{5/8}
LJ30	36	5	26 ^{1/2}	4 ^{1/2}	3	11 ^{5/8}
LJ36	42	5	24 ^{1/2}	4 ^{1/2}	3	11 ^{5/8}
LJ42	48	5	26 ^{1/2}	4 ^{1/2}	3	11 ^{5/8}
LJ54	60	5	26 ^{1/2}	4 ^{1/2}	3	11 ^{5/8}

Countertop Notch Detail

Only required if island countertop overhangs the face of the island



Note: Insulated jacket required for all grills installed into a combustable enclosure.

The best outdoor kitchen products come from:
Lynx Professional Grills,
6023 East Bandini Blvd.
Commerce, CA 90040

For more information please call,
1-888-879-2322 or visit www.lynxgrills.com

