

This Owner's Manual is provided and hosted by [Appliance Factory Parts](http://www.appliancefactoryparts.com).



# VIDALIA 983 Owner's Manual

[Shop genuine replacement parts for VIDALIA 983](#)



[Find Your VIDALIA Grill Parts - Select From 4 Models](#)

----- Manual continues below -----



# Owners Manual

Vidalia Outdoor Products  
308 Miracle Lane, Vidalia GA  
[www.vidaliagrill.com](http://www.vidaliagrill.com)

# TABLE OF CONTENTS

Thank You...	...2
Introducing the New Standard for Grilling	3
Vidalia Grill Island Insert.....	5
Operating Instructions.....	6
Lighting Instructions .....	8
Cooking Directions .....	10
Cleaning Your Grill.....	13
Directions for Indirect Cooking.....	14
Recipes .....	15

**Thank YOU** for your purchase of a Vidalia Grill. Your grill is designed for a lifetime of use. Great care and testing went into the design and development of this grill and we want you to be totally satisfied with your purchase. Most components of the grill are made from aluminum which conducts heat very evenly and very fast. You will find that even on the indirect side, your Vidalia Grill will cook everything evenly without hot or cold spots. Most internal components that come in contact with a direct flame are made from stainless steel, including the burner, which is a high quality 304 stainless steel. The marinade and Flavor Bar pans are also made from stainless steel and the burners are stainless steel tubes. The Vidalia Grill is built to last and last and last. . . who said you can't take it with you? We didn't!

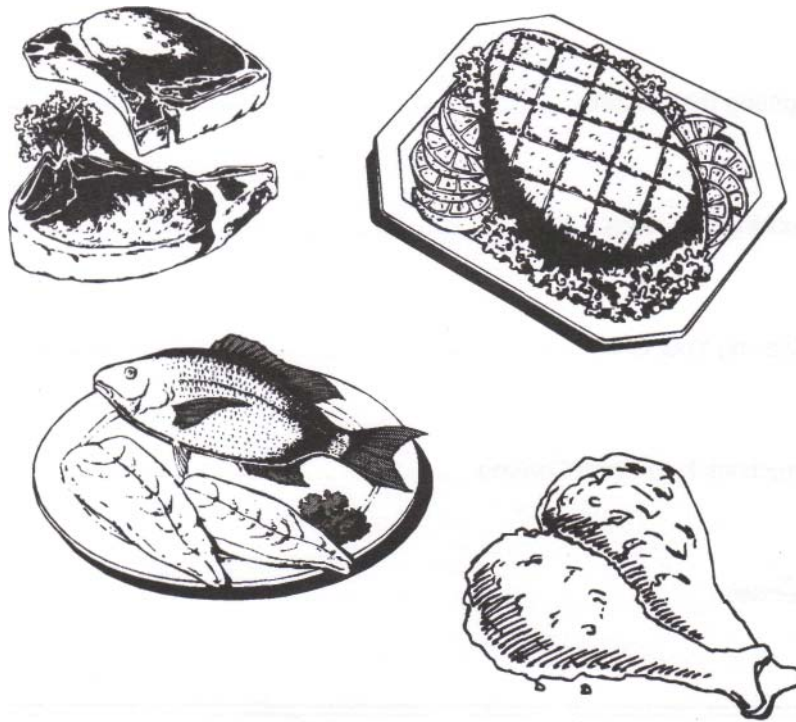

## Introducing the new standard for grilling!

The Vidalia Grill offers many features not found on traditional outdoor grills. Because of its unique reversible twin pan design and dual direct and indirect cooking surfaces, The Vidalia Grill can grill and sear to perfection and can also roast, smoke, steam, bake, boil and even fry without the addition of expensive accessories.

The Vidalia Grill cooks with the convenience of bottled or natural gas with flavor enhancements from wood or charcoal if desired. The amount of added flavor can be regulated by using more or less wood, charcoal or pellets. Simply add the wood chips or charcoal to the Flavor Bars in the left stainless steel pan that is positioned directly over the burner. Ashes from the wood or charcoal will accumulate in a stainless steel tray at the base of the grill's burner. The steel tray slides out after cooking for easy cleaning.

The right side of the grill from the center is used for indirect cooking. Since your food is never exposed to a direct flame on this side of the grill, there is never a worry about flare up. This also eliminates the need to constantly turn your food to prevent burning. Larger meats such as whole chickens, turkeys and hams can be easily and thoroughly cooked without using a rotisserie. The drippings from the food are retained in a stainless marinade pan which becomes hot when the grill is at operating temperatures. The drippings falling into the pan's heated water return flavor to the food as the water evaporates and also provides moisture to the heated air inside the grill so that food remains moist and juicy even if it is overcooked. By adding liquid seasonings to the water under the food, The Vidalia Grill can baste and marinate the food as it cooks. Apple cider vinegar, lemon juice, pineapple juice, liquid smoke or Worcestershire sauce work really well for adding extra flavor to your food.

Ready to do more? By simply lifting out the left side stainless steel Flavor Bar pan and sliding the stainless steel marinade pan from the right side of the grill to the left side, which is directly over the burner, you have converted your grill into a steamer. Now you can steam your favorite foods such as oysters, shrimp, lobster, sausage and even vegetables. You can even place food in the boiling water to boil and steam at the same time. Imagine boiling shrimp and steaming lobster at the same time! Instead of water, a small amount of cooking oil can be added to the stainless steel pan allowing you to stir-fry foods or prepare scrambled eggs and pancakes. The stainless steel pan lifts right out for quick, easy clean up.

Because of its rust free stainless steel and aluminum construction, water and years of outdoor use are not a problem. That's why we offer the following warranty:

- 99-Year rust-through warranty on grill body.
- Pro-rated burner warranty for 10 years.
- 20-Year warranty on grates & pans
- 2-Year warranty on: knobs, igniter, wheels & casters, regulator, gas hose, and manifold.

*(Warranty is for parts only and does not include shipping cost.)*

The Vidalia Grill is available in four sizes (models 440, 628, 983 and 1396). Each grill's model number relates to its square inch cooking surface.

For Additional Information Please Contact:



308 Miracle Lane • P.O. Box 1912 Vidalia, GA  
30475

**(912) 538-7570**

Toll Free: (800) 453-1668

Fax: (800) 359-3681

[www.vidaliagrill.com](http://www.vidaliagrill.com)

E-mail: [vidaliagrills@bellsouth.net](mailto:vidaliagrills@bellsouth.net)

## Vidalia Grill Island Insert

Your Vidalia Grill Island Insert comes with two (2) air boxes and a trim Kit. The actual dimensions and specifications for each model (440, 628, 983, 1396) is available on our website ([www.vidaliagrill.com](http://www.vidaliagrill.com)) under the product page for each model.

The Vidalia Grill takes air in on the right side and exhaust on the left (see inside cover of this manual for diagram of airflow). To accomplish air flow requirements for an insert, air boxes have been provided that are interchangeable.

A trim kit is also provided that creates a clean, finished look where the counter top of the island and the grill head meet.

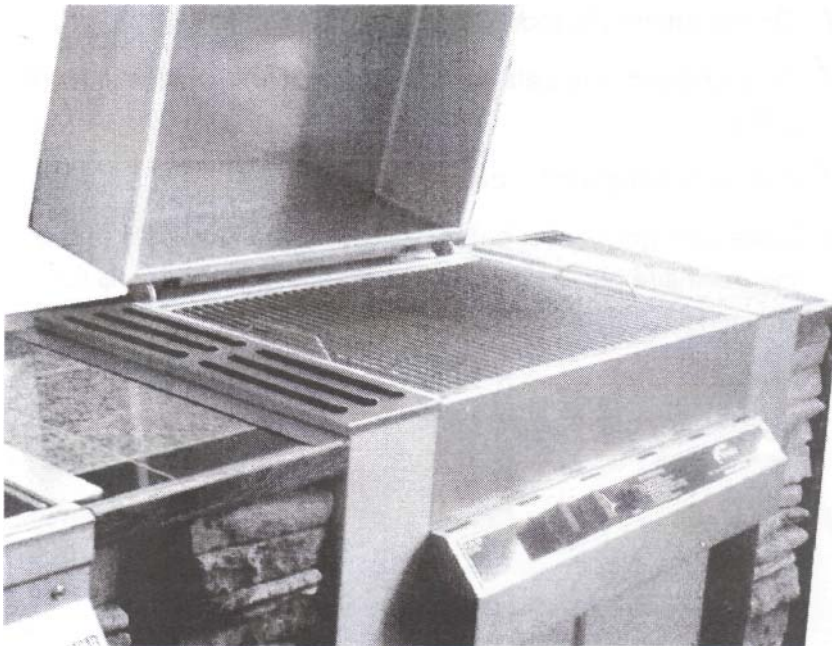

**PLEASE READ INSTRUCTIONS CAREFULLY BEFORE  
OPERATING YOUR GRILL!**

## OPERATING INSTRUCTIONS

- Open lid before attempting to light. (Lid should remain open until burner is lit).
- Follow instructions on the grill's instruction panel very carefully.
- Make sure that the marinade pan contains at least 1/2 inch of water before lighting the grill. Check frequently while cooking. Do not allow all water to evaporate while cooking. Add water carefully from the top as needed and always maintain at least 1/4 inch of water or liquid.
- Do not touch any metal parts of the grill while hot. V Do not attempt to move a hot grill.
- Keep children and pets away from a hot grill to avoid severe burns.
- Grills are designed for outdoor use only.
- Make sure grill is cool before removing the flavor bar pan or the marinade pan for cleaning or changing the positions for steaming.
- V Always use barbeque mitts or hot pads to protect hands while adding or removing food from a hot grill or adding water to the water pan.
- If there is any part of your grill or instructions that you do not understand, please call us before attempting to light. (800) 453-1668 • Monday - Friday 9:00 a.m. - 5:00 pm.

Please refer to model number when calling.

**BEFORE USING YOUR NEW GRILL FOR THE  
FIRST TIME**

Before using your new grill for the first time, it is necessary to "season" it. Remove the cooking grate(s) and the water pan from the right side of the grill and wash them in mild soap and water. Replace water pan and grate(s) and add water, approximately 1/2 inch deep, to the water pan. Light all the burners, close the lid and operate the grill for 20 minutes or so on high heat or until grill reaches 500°.. Turn off the grill and allow the grill to completely cool with lid closed. Be sure to check all the gas fittings and connections each time you use a gas-fired grill to be sure there are no leaks and make sure hoses are not touching bottom of grill. See *Example A*.

**IMPORTANT!**

**DO NOT ALLOW THE REGULATOR HOSE TO COME  
IN CONTACT WITH THE BOTTOM OF THE GRILL.**

INCORRECT

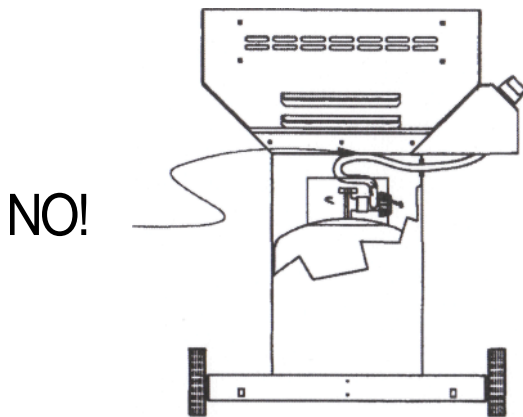

CORRECT

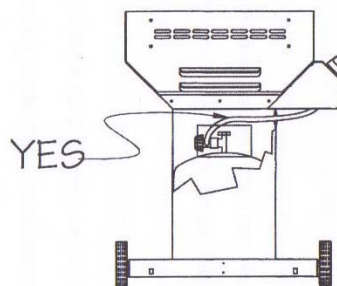

**CAUTION:** Check all hoses and connections before lighting grill for the first time.

## **LIGHTING INSTRUCTIONS**

1. Open lid.
2. Add water to the stainless steel Water Pan on the right side of the grill. Water should be at least 1/2 inch deep and should be checked frequently during the cooking process. Do not allow all of the water to evaporate before adding more. Always add water carefully by pouring it slowly from top of the grill through the grate. Do not attempt to lift the grate on a hot grill.
3. Connect gas bottle at the back of the grill. Make sure the connection on the gas bottle is facing the rear of the grill. Connect the gas bottle to the grill by turning the connector on the grill clockwise until tightened. **Make sure the gas line is not touching the bottom of the grill, (see Example A)**
4. Turn on gas at tank by turning the valve counterclockwise.
5. For Model 440 & 628, turn burners 1 & 2 on high to ignite (See Example B). For Model 983 & 1396, turn burners 2 & 3 on high to ignite (See Example C).
6. Wait 5 seconds then press and hold the igniter button until the grill lights but not for more than 10 seconds. You should hear a clicking sound when the ignitor is pressed. If you do not hear a clicking sound when the igniter button is pressed, you may need to replace the battery in the back of the igniter.
7. If ignition does not take place after 10 seconds, turn burner(s) to OFF position, wait 5 minutes with lid open, then repeat procedure beginning with number 4 above.

## **MANUAL LIGHTING PROCEDURE**

1. Do not use Manual Lighting Procedure on a hot grill.
2. Open lid.
3. Look under burner control panel and locate the 1 inch hole in the bottom of the grill cooking chamber on the left side of the front burner controls. (See example B for Model 440 & 628 or C for Model 983 & 1396).
4. Turn burners 1 & 2 on high on Model 440 & 628. Turn burners 2 & 3 on high on Model 983 & 1396.
5. IMMEDIATELY light long match and insert the tip of match into the round hole of the cooking chamber. Always use a long kitchen or preferably fireplace match. Do not attempt to manually light burner with a short paper match.
6. If the burner does not light in two or three seconds, remove match and turn burner off. DO NOT ATTEMPT TO RELIGHT!!! Please call us toll free (800) 453-1668 for assistance or further instructions.

# MODEL 628 - EXAMPLE B

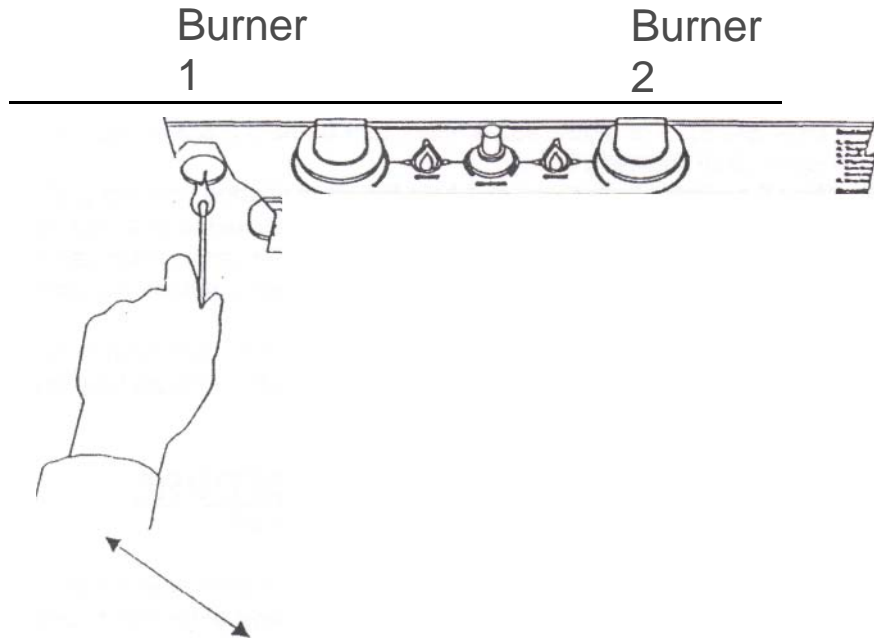

# MODEL 983 - EXAMPLE C

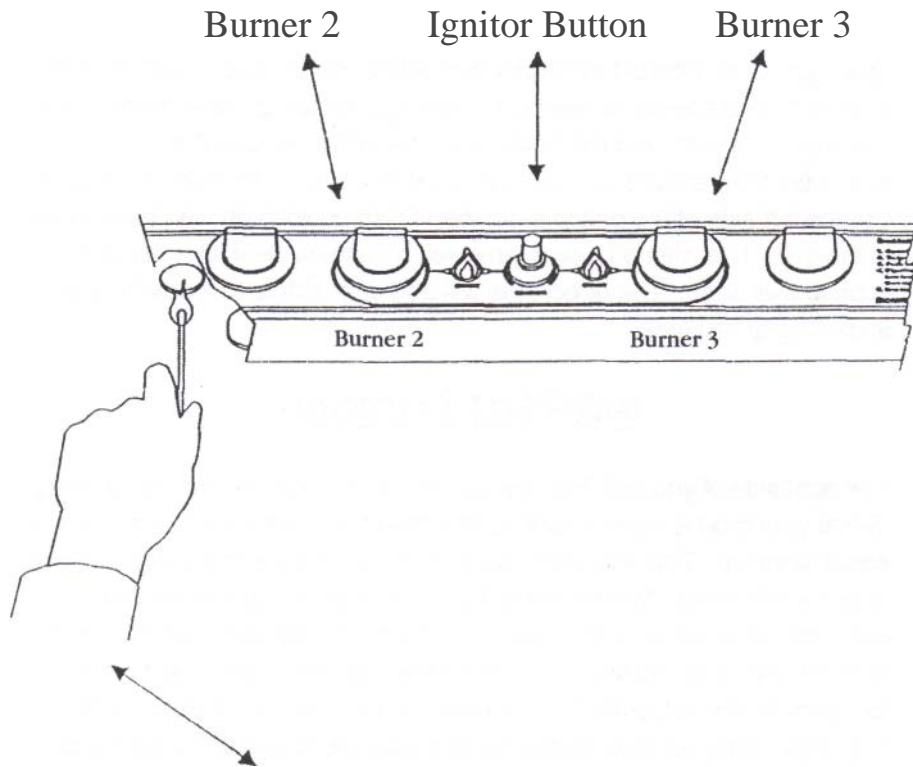

## **DIRECT COOKING**

The left side of The Vidalia Grill, from the center, is designed for grilling and searing over direct heat. On this side, the grill will have one front and one rear burner controls on Model 440 & 628 and will have four burner controls on Models 983 & 1396. These can be set at the same setting (low-high) or at different settings which allow you to have a section of this area for high temperature searing and another section for lower temperature cooking. This gives you the ability to sear at a high temperature, then cook at a lower temperature to retain more natural juices. You may choose to use the left side of the grill to sear, then finish cooking on the indirect side of the grill. This method works very well on a thick steak that you wish to cook to well done. The direct side will add sear marks to foods for that appealing grilled look.

## **INDIRECT COOKING**

The right side of you grill, from the center, is designed for indirect cooking. Since your food is never exposed to a direct flame there is never a worry about flame up. This also eliminates the need to constantly turn your food to prevent burning. Most foods will only need to be turned one time for complete browning on both sides. On the indirect side your food is browning from the top. The indirect side can be used for any foods that have a tendency to dry out when cooked, such as fish, pork or chicken. The drippings from your food on the indirect side are retained in a stainless steel pan which becomes very hot when the grill is at operating temperatures. The drippings falling into the pan's heated water add flavor and return moisture to the food as it evaporates and also provides moisture to the heated air inside the grill so that your food remains moist and juicy, even if it is overcooked. Other liquids can be added to the water pan which has a basting or marinating effect on your food as it cooks. Apple cider vinegar works well for pork or chicken, while Worcestershire sauce creates an excellent flavor on beef. It is important to note that the indirect side of the grill maintains excellent browning capabilities. Do not allow all the water to evaporate. Always maintain at least 1/4 inch of water or liquid when cooking, Adding it carefully from the top.

## SMOKING

Soak a few of your favorite wood chips in water for at least two hours, or preferably overnight. A small handful will be more than adequate since most of the smoke flavor is obtained in the first 30 minutes of cooking. You will only be using one (1) burner for smoking in order to maintain a temperature of 210 to 250 degrees. Fill water pan with at least 1/2 inch of water. Place the wood chips on top of the Flavor Bar over the burner you intend to use, usually the front. Light the front burner and turn on the lowest setting. Leave other burner(s) off. Place food on the right side of the grill away from direct flame. Close lid and maintain desired cooking temperature. For smoking a turkey, we recommend cooking at 250 degrees for the first hour then increase to 375 degrees until done. Wood pellets work very well for smoking and are available in many flavors. They are available at most stores that sell charcoal. Just follow the easy instructions on the package.

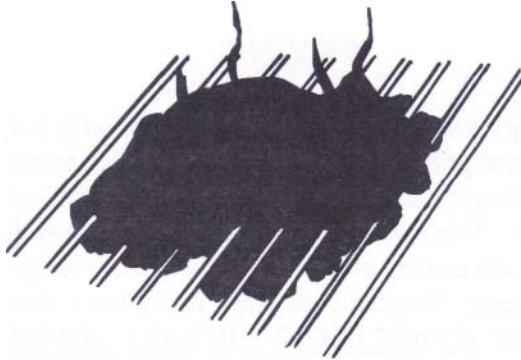

## CHARCOAL COOKING

**If you want to cook with charcoal the following directions must be followed in order not to damage your Vidalia Grill. When cooking with charcoal you will be using a combination of charcoal and gas (charcoal for flavor and gas to maintain a constant temperature 400°.)** One to two handfuls spread evenly across the top of the flavor bars on the direct side, is all that is needed to provide charcoal flavor. **Using more than the recommended amount can damage you grill because of excess heat.**

**DO NOT LET THE TEMPERATURE GUAGE ON THE HOOD EXCEED 600°.**

## **STEAMING**

Converting your grill into a steamer can be accomplished in only a matter of seconds. On a **cold grill**, remove the Flavor Bar Tray from the left side of the grill. Now simply move the marinade pan from the right side of the grill to the left side. This places the water tray directly over the burner. Add water (approximately 1-1/2 to 2 inches deep) and you're steaming your favorite seafood or vegetables. Foods such as hot dogs or shrimp can also be cooked directly in the boiling water.

- Check water frequently and add as needed to maintain a minimum of 1 inch deep.
- When grill is producing steam always raise the lid very slowly to check on food!!!!
- **Open lid approximately two inches and allow some steam to escape for a few seconds before completely opening the lid.**
- **Wear elbow length barbeque mitts when operating the grill.**

## **FRYING**

Converting your grill into a Fryer can be accomplished in only a matter of seconds. On a **cold grill**, remove the Flavor Bar Tray from the left side of the grill. Now simply move the marinade pan from the right side of the grill to the left side. This places the water tray directly over the burner, but instead of water, use a small amount of cooking oil. Your grill is now a stainless steel griddle. You can cook eggs, pancakes or even stir fry your favorite vegetables! **DO NOT CLOSE THE GRILL LID WHEN FRYING.**

## **DEEP FRY PAN - Optional**

To convert your grill for deep-frying, on a cold grill, remove the flavor bar tray from the left side of the grill. Now insert your optional deep fry pan on the left side of the grill. Add the necessary amount of cooking oil to your pan depending on what you are cooking. **Be careful not to over fill, oil can splash and create a fire hazard.** **IMPORTANT: DO NOT CLOSE LID WHEN USING DEEP FRY PAN. NEVER TRY TO REMOVE THE DEEP FRY PAN WHEN HOT. ALLOW TO COOL COMPLETELY BEFORE REMOVING.**

## CLEANING YOUR GRILL

***Because the cooking chamber is aluminum, do not use stainless steel or any other abrasive cleaner.***

Allow the grill to completely cool down after cooking. A special grate scraper was supplied with your grill. Use this to remove any food buildup on the cooking grate. Next remove the grate from your grill. Lift out the right side water pan and pour out the contents which will be mostly liquid. Wash with warm soapy water and rinse. Next, wash the grate and rinse in the same manner. A soapy steel wool pad can be used for any hard to clean spots (grates and marinade pan). Cleaning can be done outside with a garden hose if desired. Dawn dishwashing liquid works very well for this purpose. After washing, rinse with a garden hose and dry the grill with a soft cloth or towel. After drying, spray a generous coat of WD-40 on the exterior of the grill and wipe with a soft cloth leaving a good film on the grill's exterior surface. As a general rule it will not be necessary to clean the exterior of the grill frequently. It is always best to spray a light coat of WD-40 on the grill's outside surface after each use to clean and protect it. We do not recommend covering your grill. Water that might get trapped under a grill cover can stain your grill's finish. If you choose to cover your grill, make sure grill has completely cooled down and is completely dry as well. Make sure the grill cover is dry. Never place a wet cover on your grill. Always apply a generous coat of WD-40 before covering your grill to prevent staining. Staining is not covered under warranty.



## **DIRECTIONS FOR INDIRECT COOKING**

1. Add water, at least 1/4 inch deep, to the water pan on the right side of your Vidalia Grill.
2. Add one to two cups of your favorite marinade. We have found that apple cider vinegar works well with most meats.
3. Preheat grill to 400 degrees. (Note: burners do not have to be set on same setting for even indirect cooking. If one burner is on low setting and the other on a higher setting it will not effect the indirect cooking process.) The most important thing to remember is to maintain correct cooking temperature. When in doubt, start at a lower temperature. You can always increase temperature in the last few minutes of cooking to achieve the desired browning results. As a general rule, 400 degrees is the best setting. Foods such as whole chickens, ribs, pork tenderloins, turkeys and hams should be turned one time to achieve proper browning on both sides. Remember on the right side of the grill (indirect), you are cooking and browning mostly from the top down. A fish filet, such as salmon, can be easily cooked without turning. Place the filet on the right side of the grill with the skin side down. Cook until done.

You are now ready to cook pork ribs, pork tenderloins, whole chickens, whole turkeys, chicken halves, boston butts or fish. Always use a meat thermometer to insure that pork and chicken are thoroughly cooked for health and safety reasons. Season your food with your favorite seasonings before cooking.

*Welcome to  
the world of  
Vidalia Grilling!*



## **"Recipes for Indirect Cooking"**

Here are a few of our favorites. For additional recipes visit our website: [www.vidaliagrill.com](http://www.vidaliagrill.com)

### **PORK RIBS**



- Add approximately 1/4 inch of water to the marinade pan on the right side of the grill (indirect side).
- Add 1 cup apple cider vinegar (optional) to the water pan.
- Select quality baby-back ribs (Smithfield is a good brand)
- Season with Instant Vidalia Seasoning Salt (medium-heavy) and black pepper (medium)
- Brown both sides for 25-30 minutes each, on the indirect side. Start browning with bone side of rib facing up.
- After browning both sides wrap in heavy-duty foil. For best results, wrap in two layers of aluminum foil, being careful not to tear the foil.
- Place wrapped ribs back on grill (indirect) and cook for 1 hour.

Total cooking time is 2 hours at 400°.

### **PORK TENDERLOINS**

- Add approximately 1/4 inch of water to the marinade pan on the right side of the grill (indirect side). Add 1 cup apple cider vinegar (optional) to the water pan.
- Quality pork tenderloin (Smithfield is a good brand) not a whole loin.
- Season with Instant Vidalia Seasoning Salt (medium-heavy) and black pepper (medium)
- Cook both sides for 25 minutes each on the indirect side.

- After 50 minutes cut tenderloin in half at its thickest part. If you do not see blood, it is done. You will see juices but they should not be bloody. If you see bloody juices, cook for another 5-10 minutes and re-cut.
- Total cooking time 50 minutes to 1 hour at 400°.

## WHOLE TURKEY



Add approximately 1/4 inch of water to the marinade pan on the right side of the grill (indirect side). Add 1 cup apple cider vinegar (optional) to the water pan.

Quality whole chicken, 4 to 4.5 lbs.

Season with Instant Vidalia Seasoning Salt (medium-heavy) and black pepper (medium).

Cooking on the indirect side, with back of chicken facing up, cook both sides for 30 minutes each. After 1 hour, turn chicken to even browning and cook for another 30 minutes. After 1 1/2 hours leg bone should easily turn and pull out. Total cooking time 1 1/2 hours at 400°.

## BONELESS, SKINLESS CHICKEN BREAST (BSCB)

- 4 Add approximately 1/4 inch of water to the marinade pan on the right side of the grill (indirect side). Add 1 cup apple cider vinegar (optional) to the water pan.
  - + Quality BSCB.
  - Season with Instant Vidalia Seasoning Salt (medium-heavy) and black pepper (medium).
  - Cook on indirect for approximately 10 minutes on each side, depending on the thickness of the breast. After 20 minutes, cut breast. If it looks raw, cook for another 5 minutes and re-cut.
- Total cooking time approximately 20 minutes at 400°.

## WHOLE TURKEY

- 4 Add approximately 1/4 inch of water to the marinade pan on the right side of the grill (indirect side). Add 1 cup apple cider vinegar (optional) to the water pan.
- 4 Quality whole turkey, 14 to 15 lbs.
- 4 Season with Instant Vidalia Seasoning Salt (medium-heavy) and black pepper (medium).
- 4 Cook on indirect side with back of turkey facing up. Cook both sides for 1 hour each. After 2 hours, use meat thermometer to check for doneness. Temperature should read 170 degrees. Turn turkey to even browning and continue to cook until 170 degrees is achieved.



Total cooking time 2 to 2 1/2 hours at 400°-425°.

## VIDALIA ONION CHEESE BURGER

- Add approximately 1/4 inch of water to the marinade pan on the right side of the grill (indirect side). Add 1 cup apple cider vinegar (optional) to the water pan.
- 1/2 pound of ground chuck
- 1/2 each green, red and yellow bell peppers
- 2 Vidalia Onions (if available) or two large yellow sweet onions

Peel Onions. Core out onions in a cone shape. Using steak knife, begin coring the onion from the top. Core should be 2-3 inches wide across the top of the onion. **DO NOT CUT CORE THROUGH BOTTOM OF ONION.** Place cored onion on sheet of aluminum foil. Dice up 1 onion core and bell peppers. Mix diced onions and peppers with ground chuck. Season meat with Vidalia Seasoning Salt (medium-heavy) and black pepper (medium). Pack 1/4 lb. of ground chuck in onion core. Using finger push a hole in center of meat.

Fill hole with Worcestershire sauce. Wrap onion in aluminum foil (should look like Hershey Kiss)

Cook indirect for 45 minutes to 1 hour at 400°-425°.

Onion will become spongy when done. When done, punch holes in bottom of foil to allow juice to pour into grill pan. Carefully open top of foil and sprinkle shredded cheese on top of onion and reseal.

After 1 minute, remove onion from grill. Carefully remove hot foil and place onion onto a serving plate. You may cut onion into quarters or leave whole.

## **WHOLE PORK LOIN CHOPS**

- 4 Add approximately 1/4 inch of water to the marinade pan on the right side of the grill (indirect side). Add 1 cup apple cider vinegar (optional) to the water pan.
- 4 Quality whole pork loin (Smithfield is a good brand)
- 4 Cut loin into 1 to 2 inch chops
- 4 Season with Vidalia Seasoning Salt (medium) and black pepper (medium)
- 4 Cook both sides for 10-12 minutes each on the indirect side. Depending on thickness of chops, they should be done in 20-25 minutes.

Total cooking time is 20-25 minutes at 400°-425°.

## **BOSTON BUTT**

- 4 Add approximately 1/4 inch of water to the marinade pan on the right side of the grill (indirect side). Add 1 cup apple cider vinegar (optional) to the water pan.
- Quality Boston Butt
- 4 Season with Instant Vidalia Seasoning Salt (medium/heavy) and black pepper (medium/heavy)
- Brown both sides for 30-35 minutes each on the indirect side at 450°.
- 4 After browning both sides, double wrap the Boston Butt with aluminum foil, making sure it is sealed properly to lock in the juices.

- 4 Continue cooking for 3-1/2 hours at 400°. Remove meat from grill and allow meat to cool before handling.

## SHRIMP KABOKS

It should be noted that any fish filets can be cooked following this recipe. Depending on the thickness of the filet and how done you want it, will determine the length of time to cook.

- 4 Add approximately 1/4 inch of water to the marinade pan on the right side of the grill (indirect side). Add 1 cup apple cider vinegar (optional) to the water pan.

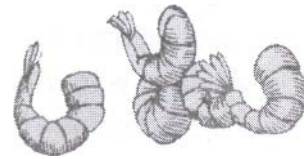

- Quality shrimp 30-40 count
- Bacon
- Teriyaki/honey marinade
- Wrap shrimp in bacon

Skewer pineapple, the bacon wrapped shrimp. Repeat until skewer is full. Cook on indirect side at 400°. When bacon starts to brown, baste skewer with Teriyaki/honey marinade and turn skewers over. Normally bacon with start browning in 10-15 minutes. Baste other side once bacon starts to brown.

Cooking time: 20-30 minutes.

## SALMON FILETS

- Add approximately 1/4 inch of water to the marinade pan on the right side of the grill (indirect side).
- Add 1 cup apple cider vinegar (optional) to the water pan.
- Quality salmon with the skin on.
- Season with Instant Vidalia Seasoning Salt (light-medium), Lawry's Garlic Seasoning (heavy), and black pepper (light-medium).

Cook on indirect side with skin side down at 400°.

Cooking time 15-20 minutes, depending on the thickness of the filet. If you like it well done but still tender and moist, cook for a total of 30 minutes.