

This Owner's Manual is provided and hosted by [Appliance Factory Parts](#).



Grand Hall FREEDOM 435 Owner's Manual

[Shop genuine replacement parts for Grand Hall
FREEDOM 435](#)



[Find Your Grand Hall Grill Parts - Select From 203 Models](#)

----- Manual continues below -----

Freedom Corner Module

1 P A R T S D I A G R A M / L I S T **1**

This diagram is provided to assist you identify parts if replacement is necessary.

Contact the place of purchase or manufacture to enquire about parts, availability and/or service.

Items included in the specification may differ from parts list, depending on region or specific dealer specification.

<i>Ref</i>	<i>Description</i>	<i>Part #</i>	<i>Qty</i>
1	Table	P0015103MA	1
2	Top Panel	P02902021A	1
3	Front Panel	P03304046C	1
	Hardware Pack	P06003103A	1

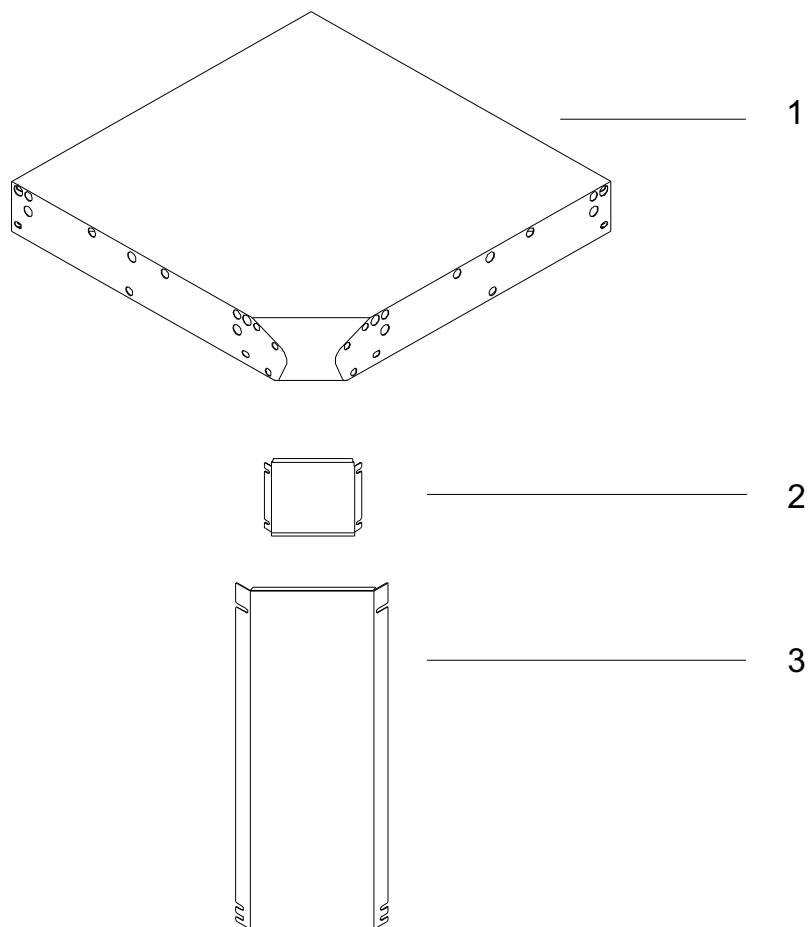

Note: • Corner module may be attached to right or left hand sides of the barbecue.
 • Attaching to sink module shown for example. Any of the Freedom modules may be attached as shown.

- ① **Attach Front Panel**
 Loosen screw 8 pcs.
 Attach front panel and tighten screws

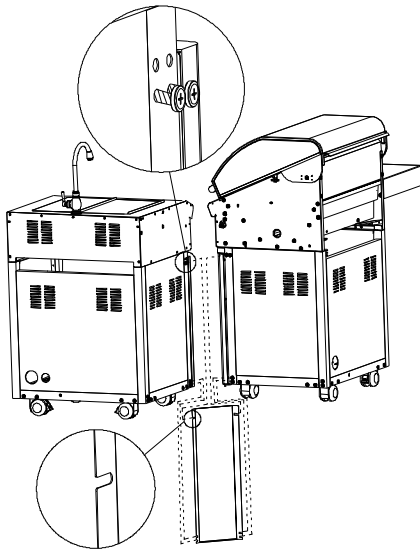

- ② **Attach Top Panel**
 Loosen screw 4 pcs.
 Attach top panel and tighten screws

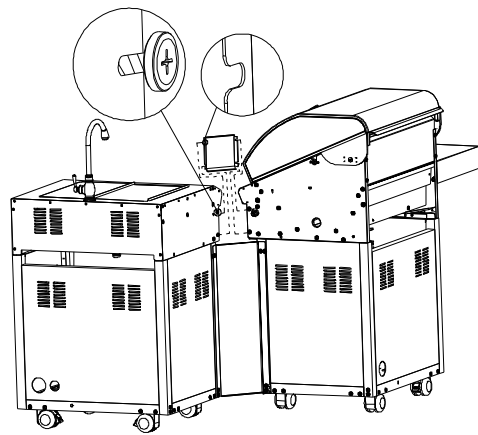

- ③ **Attach Table**

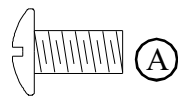
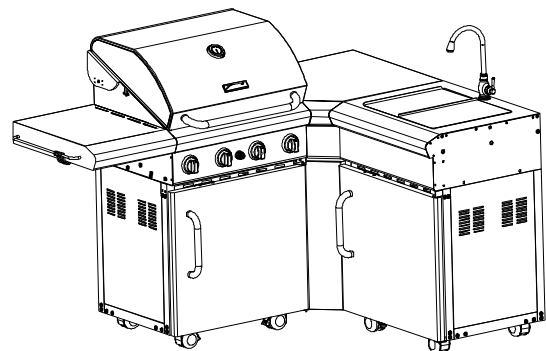
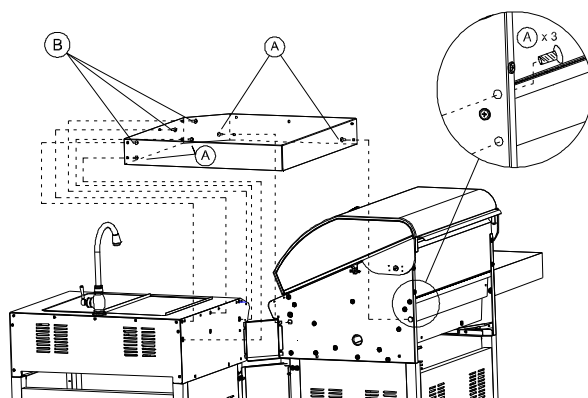

Phillips Head Screw 1/4"x3/4"
 Qty: 7

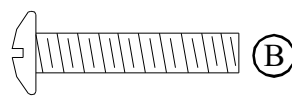

Phillips Head Screw 3/16"x1-1/4"
 Qty: 3