

This Owner's Manual is provided and hosted by [Appliance Factory Parts](#).



LG LWP-270S Owner's Manual

[Shop genuine replacement parts for LG LWP-270S](#)



[Find Your LG Washer Parts - Select From 393 Models](#)

----- Manual continues below -----



SERVICE MANUAL

PEDESTAL

For washer, dryer, and combo
LG 27"

CAUTION : READ THIS MANUAL CAREFULLY TO DIAGNOSE
CORRECTLY BEFORE SERVICING THE UNIT.

MODEL : WDP1*/WDP2*/WDP3*

1

INSTALLATION

! WARNING

Excessive Weight Hazard

Two or more people may be needed to install and move the appliance and pedestal assembly. Do not allow children to play on the drawer. Do not step on the handle.

WASHER / COMBO INSTALLATION

- 1 Remove pedestal, installation hardware, and instructions from the shipping carton.
- 2 Position the washer/combo on top of the pedestal.
NOTE : Because of the weight of the washer/combo, two or more people may be needed.

NOTE : If the washer or combo was previously installed, unplug it, disconnect the inlet hose (s) from the faucet (s), disconnect the drain hose, and drain all hoses.

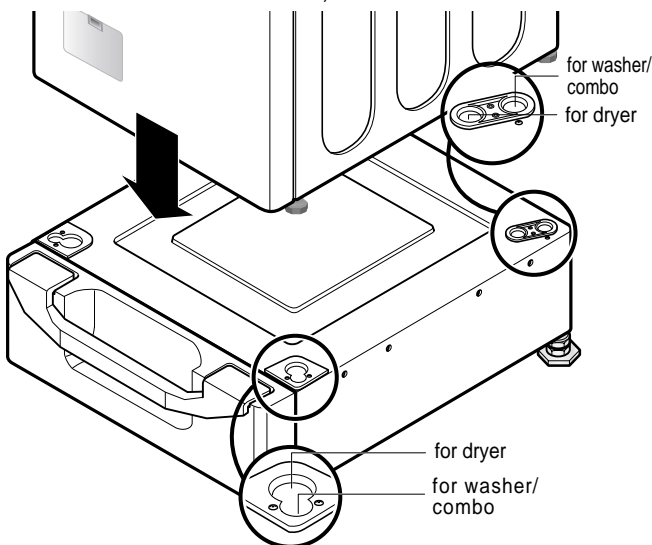

- 3 Remove the paper from the bracket.

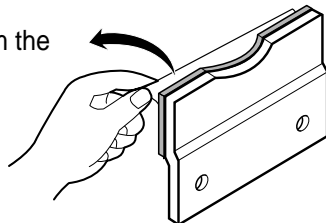

- 4 Attach the double-faced tape of the bracket to the washer/combo as shown so the bent parts of the brackets align with the edge and can be attached to the pedestal with screws.

NOTE : Attach the lower side first.

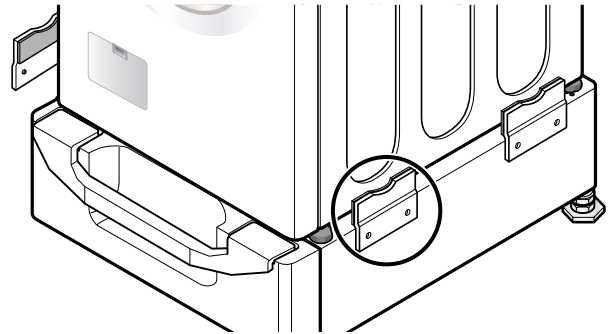

- 5 Be sure to press the adhesive parts of the brackets firmly to the appliance.

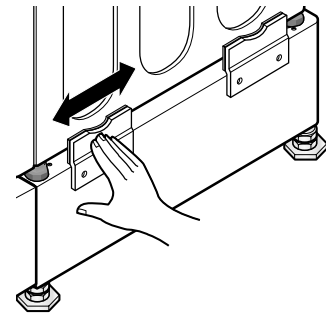

- 6 Install the eight (8) screws (supplied) to attach the brackets to the pedestal.

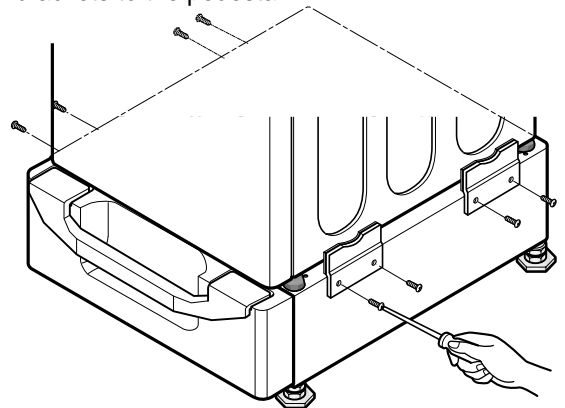

- 7 Move the washer/combo to the desired place.
NOTE : The appliance and pedestal assembly must be placed on a solid and level floor for proper operation. Adjust the legs of the appliance and pedestal by turning with a wrench. Then, adjust the lock nut toward the pedestal while holding the pedestal leg using a wrench.

1

INSTALLATION

! WARNING

Level both appliance and pedestal after the installation or service.

Make sure that all feet are stable and resting on the floor/pedestal.

When pushing down the edges of the appliance top plate diagonally, it should not move at all.

(Check all directions.)

After installation/servicing, operate the appliance to ensure it functions correctly.

DRYER INSTALLATION

1 Remove pedestal, installation hardware, and instructions from the shipping carton.

2 Position dryer on top of the pedestal.
NOTE : Because of the weight of the dryer, two or more people may be needed.

NOTE : If dryer was previously installed, uninstall it as follows:

- 1) Unplug power supply cord.
- 2) Turn off the gas supply (Gas dryer).
- 3) Pull the dryer away from the wall enough to loosen the vent clamp. Loosen the clamp and carefully remove the exhaust vent from the dryer exhaust outlet.

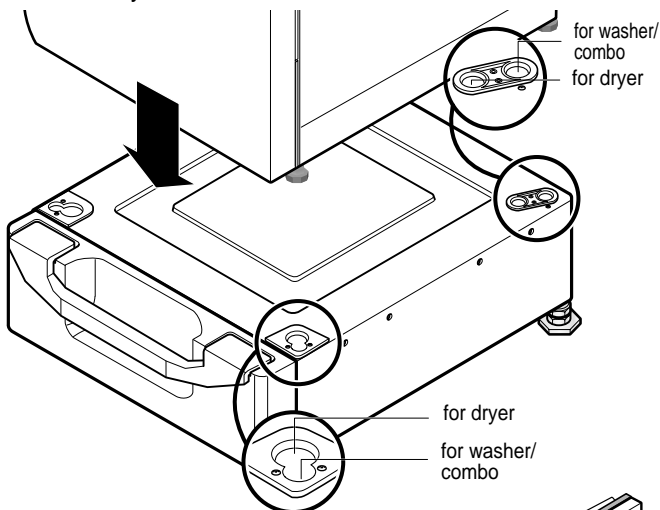

3 Remove the paper from the bracket.

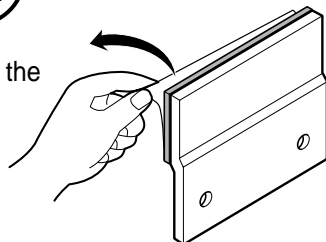

4 Attach the double-faced tape of the bracket to the dryer as shown so the bent parts of the brackets align with the edge and can be attached to the pedestal with screws.

NOTE : Attach the lower side first.

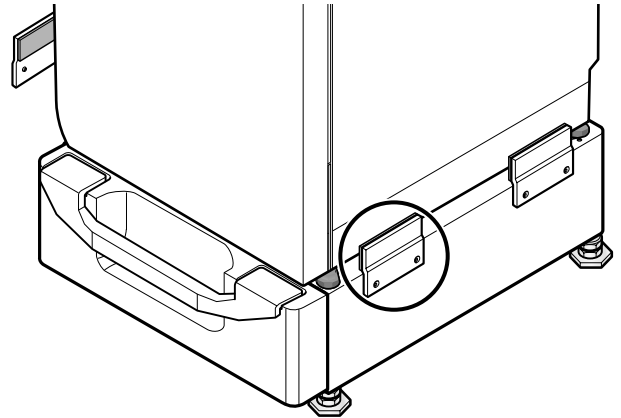

5 Be sure to press the adhesive parts of the brackets firmly to the appliance.

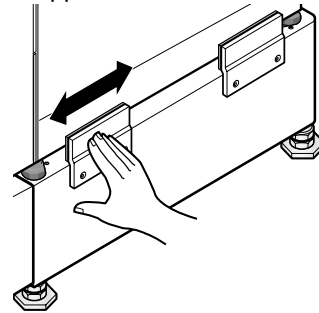

6 Install the eight (8) screws (supplied) to attach the brackets to the pedestal.

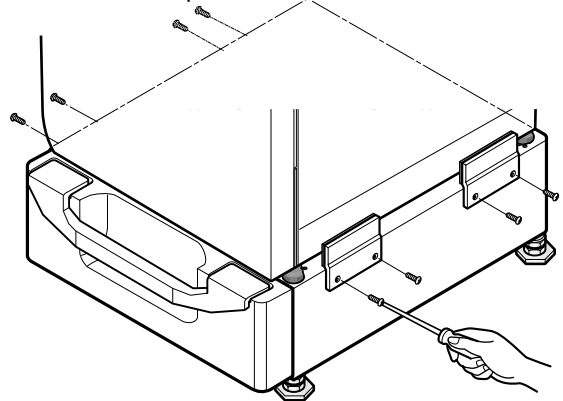

7 Move the dryer to the desired place.

NOTE : The appliance and pedestal assembly must be placed on a solid and level floor for proper operation. Adjust the legs of the appliance and pedestal by turning with a wrench. Then, adjust the lock nut toward the pedestal while holding the pedestal leg using a wrench.

2

DISASSEMBLY INSTRUCTIONS

- 1** Protect the floor with a large piece of cardboard. Lay the appliance on the cardboard. Be sure the cardboard is under the entire lower back of the appliance.

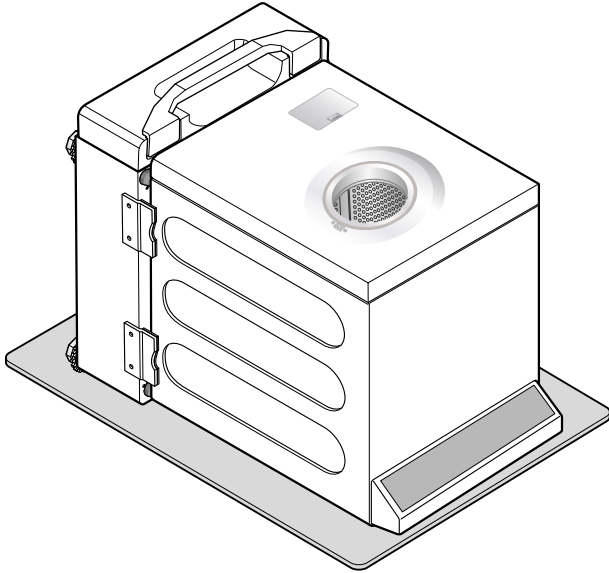

- 2** Open the drawer, and then remove the four (4) screws (two on each side) on both side of drawer.

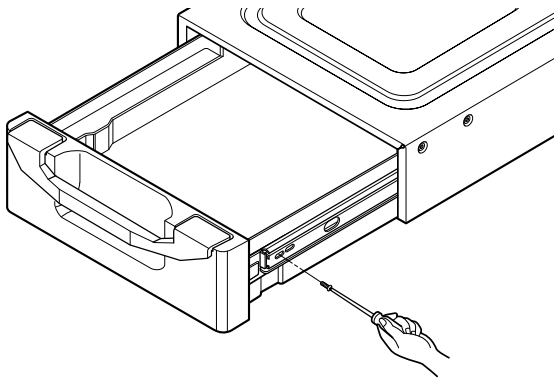

- 3** Pull up the drawer to disassemble.

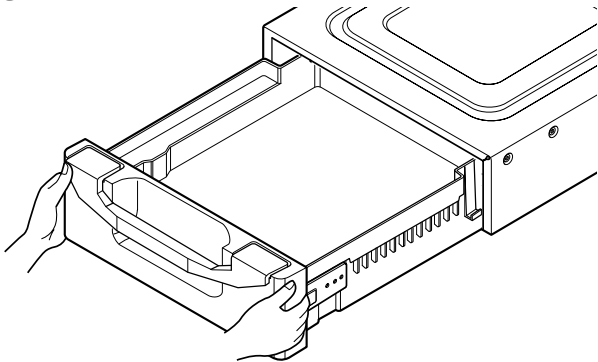

- 4** Remove three (3) screws on the drawer.

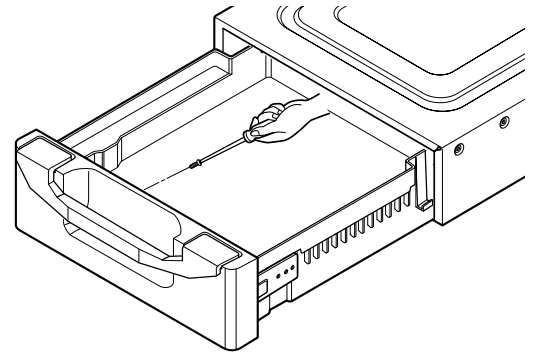

- 5** Remove two (2) screws on the either side of the drawer.

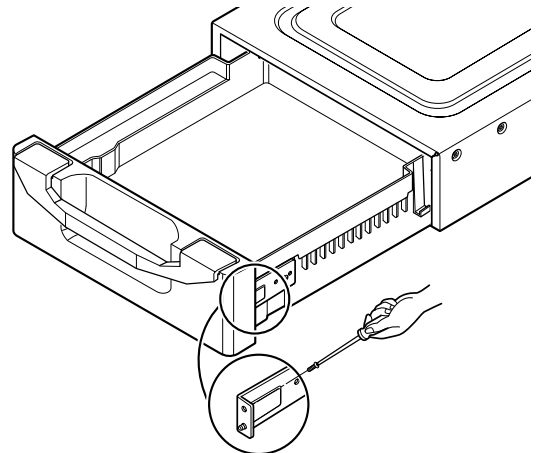

- 6** Remove six (6) screws on the front cover assembly.

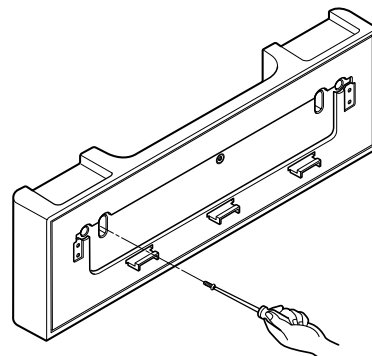

2

DISASSEMBLY INSTRUCTIONS

7 Loosen the leg using the wrench.(supplied)

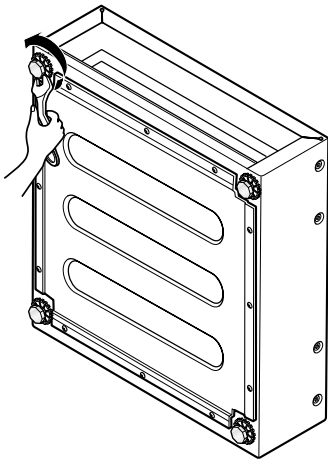

9 Remove four (4) screws (two on each side) on both side of slide.

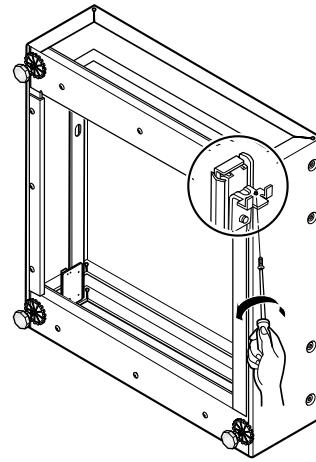

8 Remove twelve (12) screws on the bottom of the pedestal.

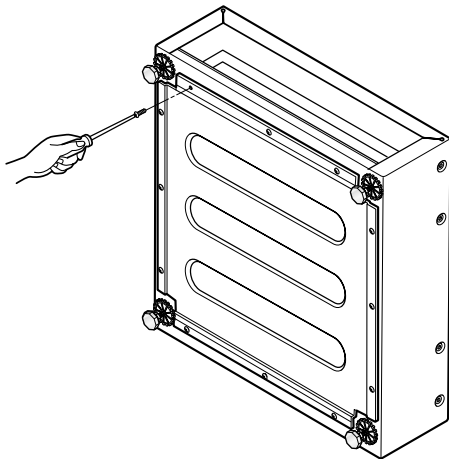

3

EXPLODED VIEW

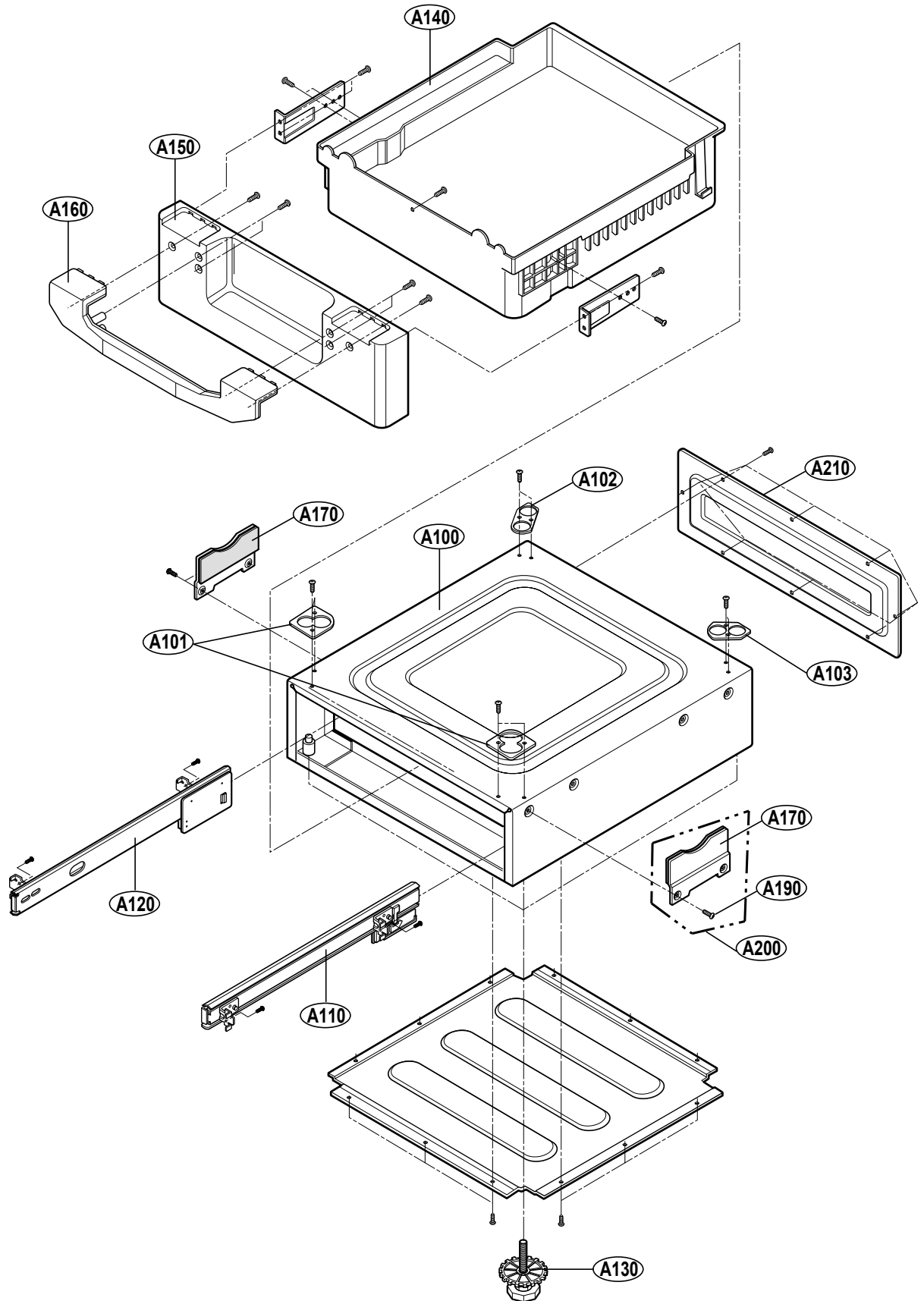



APR. 2003 PRINTED IN KOREA

P/NO:3828ER3018F