



<http://www.lgservice.com>

# LG PACKAGED TERMINAL AIR CONDITIONER/HEAT PUMP **OWNER'S MANUAL**

LG

ENGLISH

ESPAÑOL

FRANÇAIS

Please read the operating instructions and safety precautions carefully and thoroughly before installing and operating your air conditioner.

#### IMPORTANT

Please read through this manual. It contains valuable information about your air conditioner. This manual may help save time and money by explaining proper air conditioner maintenance and preventing improper use.

# TABLE OF CONTENTS

Safety Precautions .....	3
Before Operation .....	7
Introduction .....	8
Electrical Safety .....	9
Installation .....	11
Control Locations.....	13
Maintenance and Service .....	21



## FOR YOUR RECORDS

Write the model and serial numbers here:

**Model #** \_\_\_\_\_

**Serial #** \_\_\_\_\_

You can find them on a label on the side of each unit.

**Dealer's Name** \_\_\_\_\_

**Date Purchased** \_\_\_\_\_

■ Staple your receipt to this page in the event you need it to prove date of purchase or for warranty issues.



## READ THIS MANUAL

Inside you will find many helpful hints on how to use and maintain your air conditioner properly. Just a little preventive care on your part can save you a great deal of time and money over the life of your air conditioner. You'll find many answers to common problems in the chart of troubleshooting tips. If you review our chart of **Troubleshooting Tips** first, you may not need to call for service at all.



## PRECAUTION

- Contact an authorized service technician for repair or maintenance of this unit.
- Contact the installer for installation of this unit.
- The air conditioner is not intended for use by young children or invalids without supervision.
- Young children should be supervised to ensure that they do not play with the air conditioner.
- When the power cord is to be replaced, replacement work shall be performed by authorized personnel only using only genuine replacement parts.
- Installation work must be performed in accordance with the National Electric Code by qualified and authorized personnel only.



# Safety Precautions



To prevent injury to the user or other people and property damage, the following instructions must be followed.

■ Incorrect operation due to ignoring instruction will cause harm or damage. The seriousness is classified by the following indications.

**⚠ WARNING** This symbol indicates the possibility of death or serious injury.

**⚠ CAUTION** This symbol indicates the possibility of injury or damage to properties only.

■ Meanings of symbols used in this manual are as shown below.

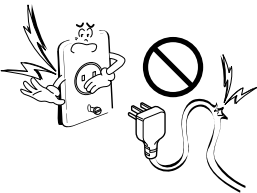
	<b>Don't do this!</b>
	<b>Be sure to follow the instruction.</b>

## ⚠ WARNING

### ■ Installation

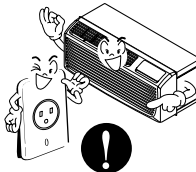
**Don't use a power cord, a plug, or a loose socket which is damaged.**

- It may cause a fire or electrical shock.



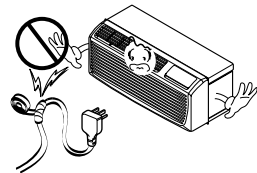
**Always plug into a grounded outlet.**

- It may cause a fire or electrical shock.



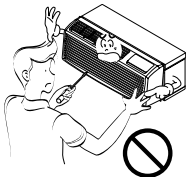
**Do not modify or extend the power cord length.**

- It will cause electric shock or fire due to heat generation.



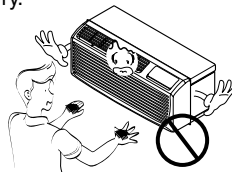
**Do not disassemble or modify products.**

- It may cause failure and electric shock.



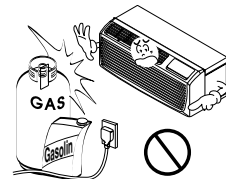
**Be caution when unpacking and installing.**

- Sharp edges may cause injury.



**Do not use the power cord near flammable gas or combustibles such as gasoline, benzene, thinner, etc.**

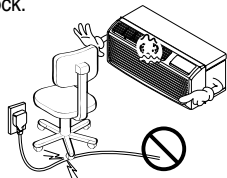
- It may cause explosion or fire.



## ■ Operation

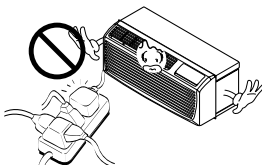
**Do not place objects on the power cord. Protect the cord from being pinched or damaged.**

- There is danger of fire or electric shock.



**Use a dedicated circuit for this appliance.**

- An overloaded circuit is a fire hazard.



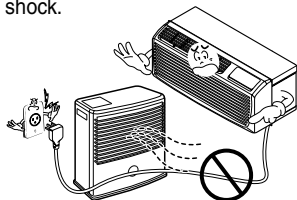
**Take the power plug out if necessary, holding the end of the plug and do not touch it with wet hands.**

- It may cause a fire or electrical shock.



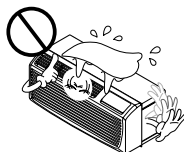
**Do not place the power cord near a heater.**

- It may cause fire and electric shock.



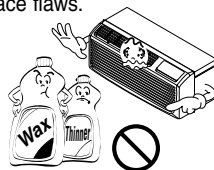
**Do not allow water to run into electric parts.**

- It will cause failure of machine or electric shock.



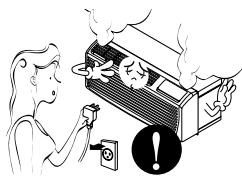
**Use a soft cloth to clean. Do not use wax, thinner, or a strong detergent.**

- The appearance of the air conditioner may deteriorate, change color, or develop surface flaws.



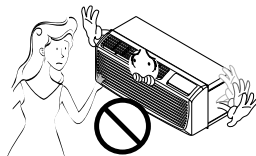
**Unplug the unit if strange sounds, odors, or smoke come from it.**

- It could represent a fire hazard.



**Do not open the suction inlet grill of the product during operation.**

- Otherwise, it may electrical shock and failure.

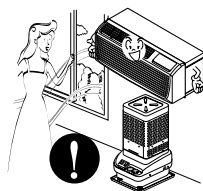


**If water enters the product, turn off the power switch of the main body of appliance. Contact service center after taking the power plug out from the socket.**



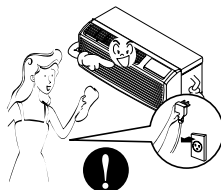
**Ventilate the room well when using this appliance together with a stove, etc.**

- Oxygen depletion could occur.



**Turn off the power and breaker when cleaning the unit.**

- Moving parts could cause injury.



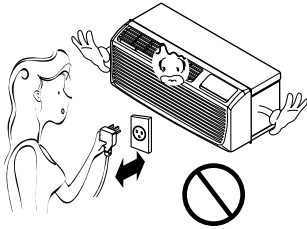
**Turn off the main power switch when not using it for a long time.**

- Prevent accidental startup and the possibility of injury.



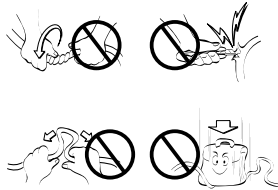
**Do not operate or stop the unit by inserting or pulling out the power plug.**

- It will cause electric shock or fire due to heat generation.



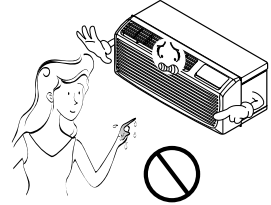
**Do not damage or use an unspecified power cord.**

- It will cause electric shock or fire.



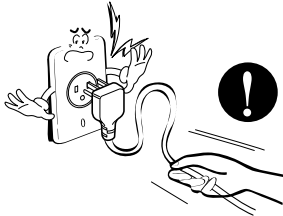
**Do not operate with wet hands or in damp environment.**

- It will cause electric shock.



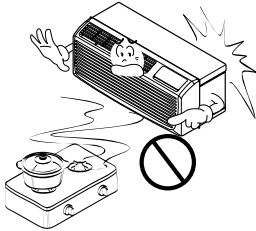
**Hold the plug by the end when taking it out.**

- It may cause electric shock and damage.



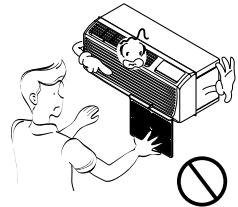
**When gas leaks, open the window for ventilation before operating the unit.**

- Otherwise, it may cause an explosion and a fire.



**Never touch the metal parts of the unit when removing the filter.**

- They are sharp and may cause injury.

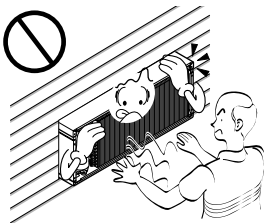


**CAUTION**

## Installation

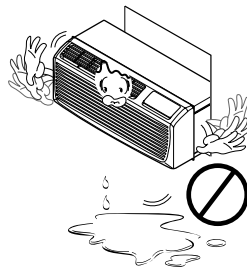
**Install the product so that the noise or exhaust from the outdoor unit may not cause any damage to the neighbors.**

- Be considerate of your neighbor.



**Be sure the product is level front-to-back and side-to-side when installing.**

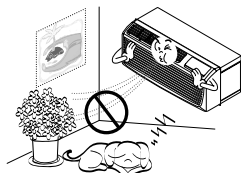
- It may cause vibration or water leakage.



## ■ Operation

**Do not put a pet or house plant where it will be exposed to direct air flow.**

- It is not good to sit in the draft.



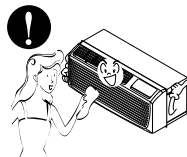
**Do not block the inlet or outlet of air flow.**

- It may cause product failure.



**Use a soft cloth to clean. Do not use wax, thinner, or a strong detergent.**

- The appearance of the air conditioner may deteriorate, change color, or develop surface flaws.



**Do not step on the indoor/outdoor unit and do not put anything on it.**

- It may cause an injury through dropping of the unit or falling down.



**Always insert the filter securely. Clean it every two weeks.**

- Operation without filters will cause failure.



**Do not drink water drained from the air conditioner.**

- It contains every contaminant condensed from the air and could cause health issues.



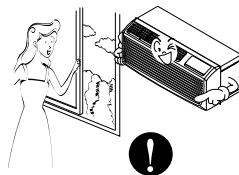
**Be cautious not to touch the sharp edges when installing.**

- A severe cut or other injury could result.



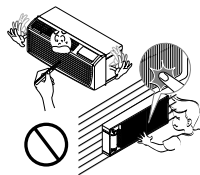
**Avoid excessive cooling and perform ventilation sometimes.**

- Use the ventilation function to circulate air without cooling or heating



**Do not insert hands or other objects through the air inlet or outlet during operation.**

- Electrical and moving parts could cause shock or injury.



**If the liquid from the batteries gets onto your skin or clothes, wash it well with clean water. Do not use the remote if the batteries have leaked.**

- The chemicals in batteries could cause burns or other health hazards.



**If you eat the liquid from the batteries, brush your teeth and see doctor. Do not use the remote if the batteries have leaked.**

- The chemicals in batteries could cause burns or other health hazards.



# Before Operation

## Preparing for Operation

1. Contact an installation specialist for installation.  
This is NOT a do-it-yourself project.
2. Plug in the power plug properly.
3. Use a dedicated circuit.
4. Do not use an extension cord. Consult a professional installer or electrician.
5. Do not start/stop operation by plugging/unplugging the power cord.
6. If the cord/plug is damaged, replace it with only an authorized replacement part.

## Usage

1. Being exposed to direct airflow for an extended period of time could be hazardous to your health. Do not expose occupants, pets, or plants to direct airflow for extended periods of time. In other words, don't sit in the draft.
2. Due to the possibility of oxygen deficiency, ventilate the room when used together with stoves or other heating devices.
3. Do not use this air conditioner for non-specified special purposes (e.g. preserving precision devices, food, pets, plants, and art objects). Such usage could damage the items.

## Cleaning and Maintenance

1. Do not touch the metal parts of the unit when removing the filter. Injuries can occur when handling sharp metal edges.
2. Do not use water to clean inside the air conditioner. Exposure to water can destroy the insulation, leading to possible electric shock.
3. When cleaning the unit, first make sure that the power and breaker are turned off. The fan rotates at a very high speed during operation. There is a possibility of injury if the unit's power is accidentally triggered on while cleaning inner parts of the unit.

## Service

For repair and maintenance, contact your authorized service dealer.

# Introduction

## Symbols Used in this Manual



This symbol alerts you to the risk of electric shock.



This symbol alerts you to hazards that could cause harm to the air conditioner.

### **NOTICE**

This symbol indicates special notes.

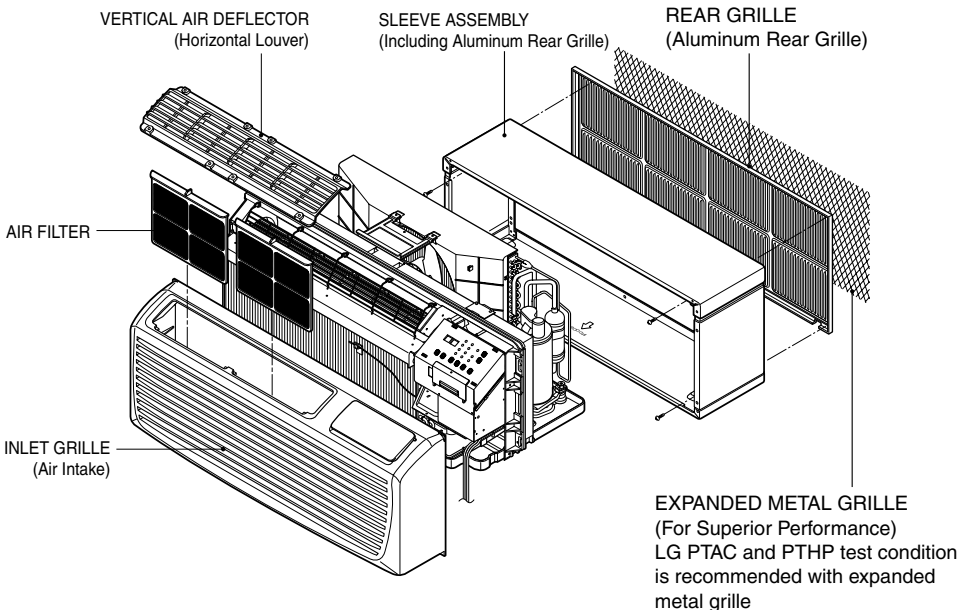
## Features

### **⚠ WARNING**

This appliance should be installed in accordance with the National Electric Code. Expanded Metal Grille Should be applied for better performance in PTAC and PTHP Units. For Installation purpose and better appearance Aluminium or Architectural grille can be applied in PTAC and PTHP Units.

### THE SLEEVE AND THE REAR GRILLE

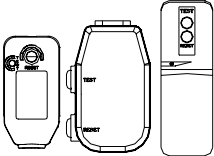
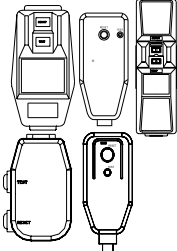
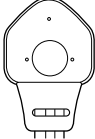
(Available as an option)










# Electrical Safety

## Electrical Data

115V~	230V~	265V~	
			Power cord may include a current interrupter device. A test and reset button is provided on the plug case. The device should be tested on a periodic basis by first pressing the TEST button and then the RESET button. If the TEST button does not trip or if the RESET button will not stay engaged, discontinue use of the air conditioner and contact a qualified service technician.

### NOTICE

The shape may be different according to its model.

Use Wall Receptacle	Power Supply
 Standard 208/230V, 3-wire grounding receptacle rated 15A	Use 15 AMP. time delay fuse or 15 AMP. Circuit breaker.
 Standard 208/230V, 3-wire grounding receptacle rated 20A	Use 20 AMP. time delay fuse or 20 AMP. Circuit breaker. (2500W Heater 15AMP. Circuit Breaker)
 Standard 208/230V, 3-wire grounding receptacle rated 30A	Use 30 AMP. time delay fuse or 30 AMP. Circuit breaker.
 Standard 265V grounding receptacle rated 20A	Use 20 AMP. time delay fuse or 20 AMP. Circuit breaker.
 Standard 265V grounding receptacle rated 30A	Use 30 AMP. time delay fuse or 30 AMP. Circuit breaker.

### NOTICE

DO NOT USE AN EXTENSION CORD on 230, 208, and 208/230, 265 Volt units.

All wiring should be made in accordance with local electrical codes and regulations.

Aluminum house wiring may pose special problems. Consult a qualified electrician.

### ⚠ WARNING

**Never push the test button during operation. Otherwise this plug can damaged.**

This device contains chemicals, including lead, known to the State of California to cause cancer, birth defects, or other reproductive harm.

Wash hands after handling.

Do not remove, modify, or immerse this plug. If this device trips, the cause should be corrected before further use.

### ⚠ CAUTION

The conductors inside this cord are surrounded by shields, which monitor leakage current.

These shields are not grounded.

Periodically examine the cord for any damage. Do not use this product in the event the shields become exposed.

Avoid shock hazard! This unit cannot be serviced. Opening the tamper-resistant, sealed portion of the unit voids all warranties and performance claims. This unit is not intended to be an ON/OFF switch.

## Electrical Safety

### **IMPORTANT (PLEASE READ CAREFULLY)**

#### **FOR THE USER'S PERSONAL SAFETY, THIS APPLIANCE MUST BE PROPERLY GROUNDED**

The power cord of this appliance is equipped with a three-prong (grounding) plug. Use this with a standard three-slot (grounding) wall power outlet to minimize the hazard of electric shock. The customer should have the wall receptacle and circuit checked by a qualified electrician to make sure the receptacle is properly grounded.

#### **DO NOT CUT OR REMOVE THE THIRD (GROUND) PRONG FROM THE POWER PLUG.**

#### **A. SITUATIONS WHEN THE APPLIANCE WILL BE DISCONNECTED OCCASIONALLY**

Because of potential safety hazards, we strongly discourage the use of an adapter plug. However, if you wish to use an adapter, a TEMPORARY CONNECTION may be made. Use UL-listed adapter, available from most local hardware stores.

The large slot in the adapter must be aligned with the large slot in the receptacle to assure a proper polarity connection.

### **⚠ CAUTION**

Attaching the adapter ground terminal to the wall receptacle cover screw does not ground the appliance unless the cover screw is metal, and not insulated, and the wall receptacle is grounded through the house wiring. The customer should have the circuit checked by a qualified electrician to make sure the receptacle is properly grounded.

Disconnect the power cord from the adapter, using one hand on each. Otherwise, the adapter ground terminal might break. DO NOT USE the appliance with a broken adapter plug.

#### **B. SITUATIONS WHEN THE APPLIANCE WILL BE DISCONNECTED OFTEN**

Do not use an adapter plug in these situations. Unplugging the power cord frequently can lead to an eventual breakage of the ground terminal. The wall power outlet should be replaced by a three-slot (grounding) outlet instead.

#### **USE OF EXTENSION CORDS**

Because of potential safety hazards, we strongly discourage the use of an extension cord. However, if you wish to use an extension cord, use a CSA certified/UL-listed 3-wire (grounding) extension cord.

# Installation

## How to Install the Unit

### ⚠ CAUTION

- There are sharp edges that can cause serious cuts.
- If the unit is to be installed close to the seaside, it needs additional treatment on the heat exchanger.
- When lifting the air conditioner, it is **HEAVY**.  
Use 2 people to lift.

**For existing sleeve,** you should measure the wall sleeve dimensions.

You can install the new air conditioner according to these installation instructions to achieve the best performance. All wall sleeves used to mount the new air conditioner must be in good structural condition and have the rear grille that securely attaches to the sleeve or the flange of the sleeve to secure the new air conditioner.

- To avoid vibration and noise, make sure the unit is installed securely and firmly.

When installing the sleeve, make certain there is nothing within 20" of the back that would interfere with heat radiation and exhaust air flow.

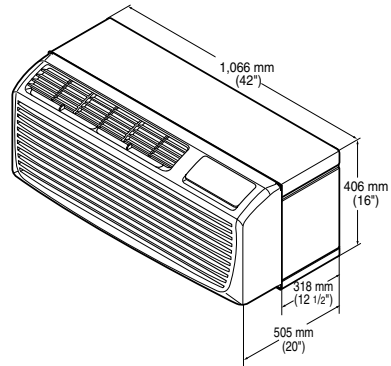
### ⚠ CAUTION

- Before installation, Check the insulation on the inner side of the sleeve. If there is no insulation, place the insulation.
- Check the bottom corner's joint gap of the sleeve, If there is, fill the gap with putty.

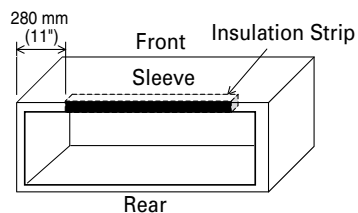
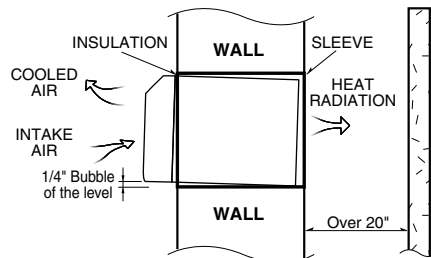
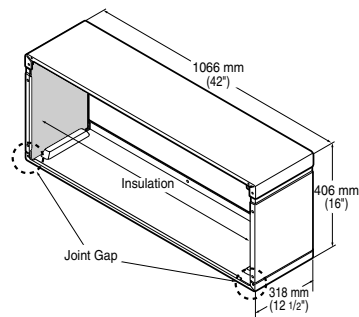
**NOTICE** To maintain the best performance of the LG PTAC, an insulation strip must be attached. The insulation strip is provided with the box. Refer to the diagram below.

- 1) Take out the insulation strip from the upper packing.
- 2) Attach the insulation strip onto the rear upper side of the wall sleeve.
- 3) If anyone would like to improve unit energy efficiency, it is recommended the change of outside grille for an unit protection and an addition of a plastic rear grille. (This is optional.)

### Dimension of air conditioner

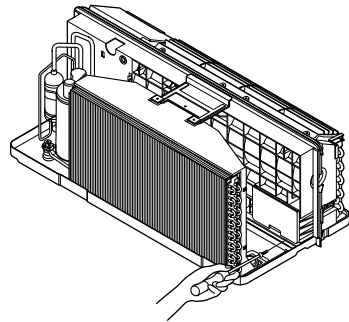


### Dimension of sleeve assembly (optional)

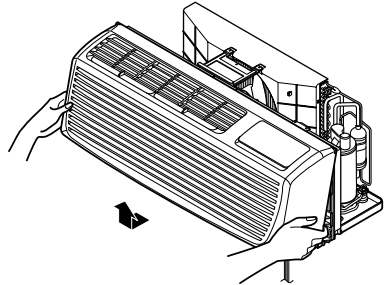


**• UNIT INSTALLATION**

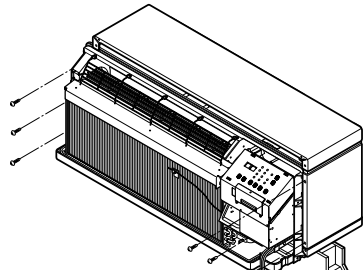
1. Remove the shipping screw from the ventilation door.



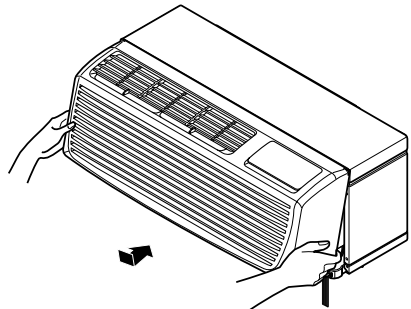
2. Remove the front grille by pulling it out at the bottom to release it, then lift it up along the unit top front.



3. Slide the unit into the wall sleeve and secure with 6 screws through the unit flange holes.

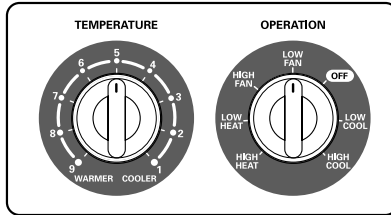


4. Reinstall the front grille by hooking the top over the unit top, then pushing it in at the bottom.



# Control Locations

## Manual Controls



### TEMPERATURE CONTROL

Set the Thermostat control to the desired temperature mark 5 (the mid-point is a good starting position). If the room temperature is not satisfactory after a reasonable time, adjust the control to a cooler or warmer setting, as appropriate.

### OPERATION MODE SELECTOR

OFF	Turns air conditioner off.
LOW FAN	Low speed fan operation without cooling.
HIGH FAN	High speed fan operation without cooling.
LOW COOL	Cooling with the low speed fan operation.
HIGH COOL	Cooling with the high speed fan operation.
LOW HEAT	Heating with the low speed fan operation.
HIGH HEAT	Heating with the high speed fan operation.

### • VENTILATION

The ventilation lever is located to the lower left side of the unit.

The ventilation lever must be in the CLOSE position in order to maintain the best cooling conditions.

When fresh air is necessary in the room, set the ventilation lever to the OPEN position.

The damper is opened and outdoor air is drawn into the room.

This will reduce the cooling or heating efficiency.

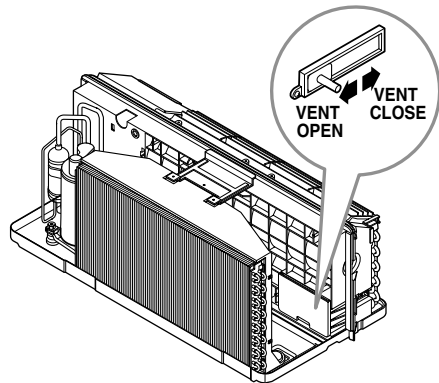
### ▲ CAUTION

When the air conditioner has been running and is turned off or set to the fan position, wait at least 3 minutes before resetting to the cooling operation.

**Note:** A slight heat odor may come from the unit when first switching to HEAT after the cooling season is over.

This odor, caused by fine dust particles on the heater, will disappear quickly.

This is harmless.

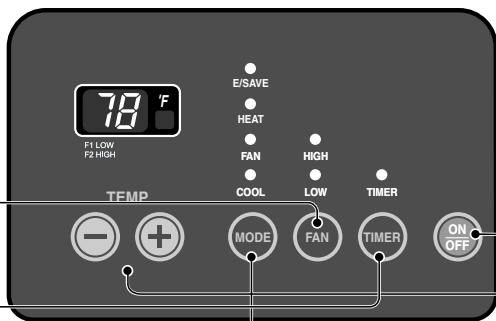


# Electronic Controls

The controls will look like one of the following.

## FAN SPEED

- Every time you push this button, it cycles through the settings as follows: {High(F2) → Low(F1) → High(F2) → Low(F1)}



## POWER

- To turn the air conditioner ON, push this button. To turn the air conditioner OFF, push the button again.
- This button takes priority over any other button.

## MODE

- Push this button to cycle through the modes from COOL → FAN → HEAT → COOL.
- COOL
  - Fan runs continually for normal cooling operation.
- ENERGY SAVER
  - The fan stops when the compressor stops cooling. Approximately every 3 minutes the fan will turn on and the unit will check the room air temperature to determine if cooling is needed.
- FAN
  - Fan operation without heating or cooling.
- HEAT
  - Fan runs continually for normal heating operation.

## TEMPERATURE SETTING

- Use this button to automatically control the temperature of the room. The temperature can be set within a range of 54° F(12°C) to 86° F(30°C) by increments of 2° F(1°C).
- The setting appears in the display.

## TIMER

- SHUT-OFF TIME
  - You will usually use shut-off time while you sleep.
  - If unit is running, use Timer to set number of hours until shut-off.
  - For your sleeping comfort, once Time is set, the Temperature setting will raise 2° F(1°C) after 30 minutes, and once again after another 30 minutes.
  - Push Timer to cycle through the settings from 1 Hour → 2 Hours → ... → 12 Hours maximum.

## Self-Diagnosis

### FUNCTION:

If the unit has a malfunction, a green OPERATION LED located on the Display PCB used by the unit to indicate the errors.

### USE:

If the customer has to register a complaint to the service center, he can be very clear about registering the complaint that what is happening & by referring the user's manual the customer can clearly define the problem.

So that the engineer should go fully prepared with the prescribed tools to be used regarding that problem. It also keeps the customer aware about the unit.

Here are some of the problems defined below for which the LED indicates by flashing number of times the error has been recorded against it.

The errors are the mentioned which is as follows:

#### • Electrical Controls

<b>ON</b>	Normal
<b>OFF</b>	No power / failed board
<b>Fault Codes</b>	
CH 01	Indoor Air Thermistor Error
CH 02	Indoor Coil Thermistor Error
CH 03	Outdoor Air Thermistor Error (PTHP Only)
CH 04	Outdoor Coil Thermistor Error (PTHP Only)
CH 05	Mode Error
CH 06	Set point Error
CH 07	Bad Thermistor Wiring
CH 09	Pressure Switch Error

#### • Manual Controls

<b>ON</b>	Normal
<b>OFF</b>	No power / failed board
<b>Fault Codes</b>	
1	Indoor Air Thermistor Error
2	Indoor Coil Thermistor Error
3	Outdoor Air Thermistor Error (PTHP Only)
4	Outdoor Coil Thermistor Error (PTHP Only)
5	Mode Error
6	Set point Error
7	Bad Thermistor Wiring
LED Flash Rate	0.25 sec On per flash, 0.25 sec OFF between flashes, 2.00 sec OFF between codes.

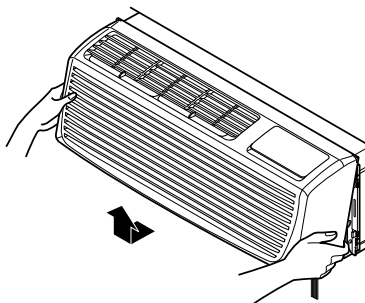
## Additional Controls

### • REMOVING THE FRONT GRILLE

Additional controls are available after removing the front grille and option cover of control box.

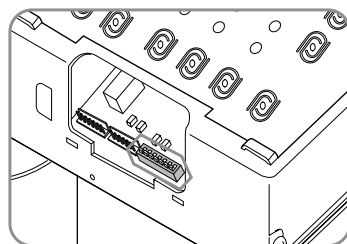
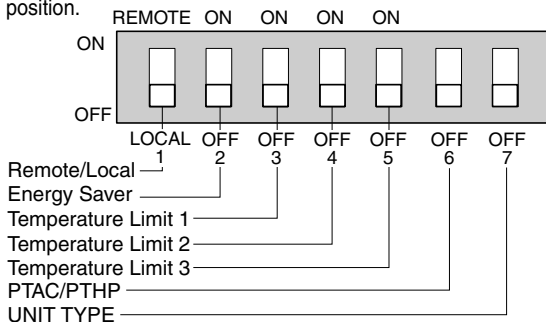
To remove the front grille, pull out the bottom of front grille and then lift up.

To replace the front grille, place the tabs over the top of the unit and push the bottom of front grille until the clips snap into place.



### • ADDITIONAL CONTROLS

The additional controls are located behind the option cover of control box. The standard settings will be in the OFF position. The authorized servicer has to check switches and ensure the switches are in the desired position.



### • TEMPERATURE LIMITING

Temperature Limiting can save money by limiting the lowest temperature for cooling and the highest temperature for heating. The temperature limiting is controlled by switches #3 - #5.

This temperature limiting is not available with the Remote Wall Thermostat.

#3	#4	#5	Cooling Operation		Heating Operation	
Temperature Limit 1	Temperature Limit 2	Temperature Limit 3	Lowest Temp.	Highest Temp.	Lowest Temp.	Highest Temp.
OFF	OFF	OFF	54° F (12.2° C)	86° F (30.0° C)	54° F (12.2° C)	86° F (30.0° C)
ON	OFF	OFF	56° F (13.3° C)	86° F (30.0° C)	54° F (12.2° C)	84° F (28.9° C)
OFF	ON	OFF	58° F (14.4° C)	86° F (30.0° C)	54° F (12.2° C)	82° F (27.8° C)
ON	ON	OFF	60° F (15.5° C)	86° F (30.0° C)	54° F (12.2° C)	80° F (26.7° C)
OFF	OFF	ON	62° F (16.6° C)	86° F (30.0° C)	54° F (12.2° C)	78° F (25.5° C)
ON	OFF	ON	64° F (17.7° C)	86° F (30.0° C)	54° F (12.2° C)	76° F (24.4° C)
OFF	ON	ON	66° F (18.9° C)	86° F (30.0° C)	54° F (12.2° C)	74° F (23.3° C)
ON	ON	ON	68° F (20.0° C)	86° F (30.0° C)	54° F (12.2° C)	72° F (22.2° C)

#6	#7	Unit Type
OFF	OFF	Cooling+Electric Heater+Heat Pump
OFF	ON	Cooling+Electric Heater
ON	OFF	Heat Pump Only
ON	ON	Cooling Only

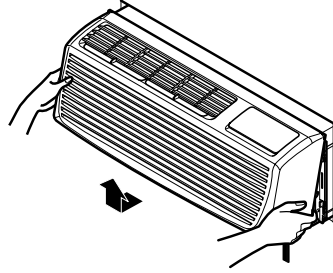


## • REMOVING THE FRONT GRILLE

Additional controls are available after removing the front grille and option cover of control box.

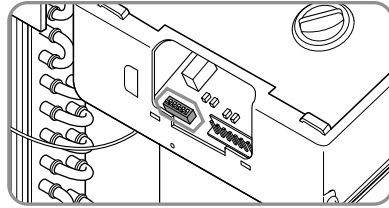
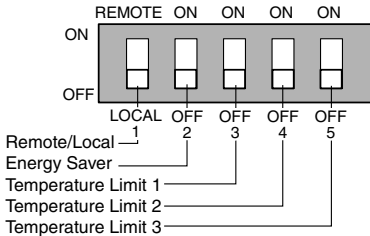
To remove the front grille, pull out the bottom of front grille and then lift up.

To replace the front grille, place the tabs over the top of the unit and push the bottom of front grille until the clips snap into place.



## • ADDITIONAL CONTROLS

The additional controls are located behind the option cover of control box. The standard settings will be in the OFF position. The authorized service man has to check switches and ensure the switches are in the desired position.



## • TEMPERATURE LIMITING

Temperature Limiting can save money by limiting the lowest temperature for cooling and the highest temperature for heating. The temperature limiting is controlled by dip switch #3 - #5.

This temperature limiting is not available with the Remote Wall Thermostat.

#3	#4	#5	Cooling Operation		Heating Operation	
Temperature Limit #1	Temperature Limit #2	Temperature Limit #3	Lowest Temp.	Highest Temp.	Lowest Temp.	Highest Temp.
OFF	OFF	OFF	54°F (12.2°C)	86°F (30.0°C)	54°F (12.2°C)	86°F (30.0°C)
ON	OFF	OFF	56°F (13.3°C)	86°F (30.0°C)	54°F (12.2°C)	84°F (28.9°C)
OFF	ON	OFF	58°F (14.4°C)	86°F (30.0°C)	54°F (12.2°C)	82°F (27.8°C)
ON	ON	OFF	60°F (15.5°C)	86°F (30.0°C)	54°F (12.2°C)	80°F (26.7°C)
OFF	OFF	ON	62°F (16.6°C)	86°F (30.0°C)	54°F (12.2°C)	78°F (25.5°C)
ON	OFF	ON	64°F (17.7°C)	86°F (30.0°C)	54°F (12.2°C)	76°F (24.4°C)
OFF	ON	ON	66°F (18.9°C)	86°F (30.0°C)	54°F (12.2°C)	74°F (23.3°C)
ON	ON	ON	68°F (20.0°C)	86°F (30.0°C)	54°F (12.2°C)	72°F (22.2°C)

**• REMOTE/LOCAL CONTROL**

When remote/local switch #1 is on, it allow the unit to operate by the Remote Wall Thermostat. The unit control by knobs are not available.

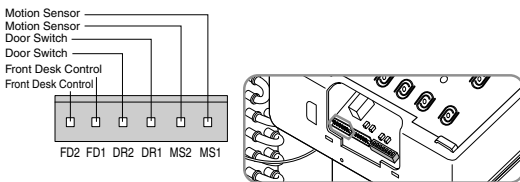
**• ENERGY SAVER**

The energy saver switch #2 is on. This switch is set at cycle fan to provide continuous fan operation in cool or heat modes. When the switch is off the continuous fan allows continuous circulation of room air and make the more balanced temperature of the room. When the switch is on, the fan is on or off with the compressor or with the heater.

**• FRONT DESK CONTROL**

When the pair wire is connected to the connector FD2 and FD1, the unit can be turned ON or OFF with a switch located at the Front Desk Control panel. When the front desk switch is ON, the fan operates according to the setting without working compressor and heater. When the front desk switch is OFF, the unit can operate according to the setting of controls.

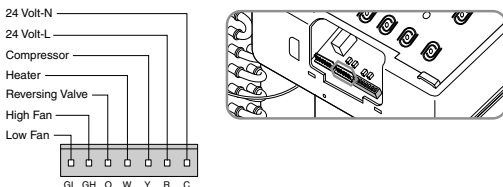
Wire # AWG	Maximum Length
#22	600 ft (180 m)
#20	900 ft (270 m)
#18	1500 ft (450 m)
#16	2000 ft (610 m)



(Molex Housing Spec 396-06V)

**• REMOTE WALL THERMOSTAT**

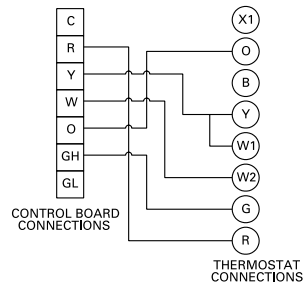
When the wires are connected, the unit will be controlled by a remote wall thermostat. The thermostat connections supply the 24 Volt AC. When you install the digital/electronic thermostat, you must set it to 24 Volt AC. See the installation Instruction in this manual for the Remote Wall Thermostat.



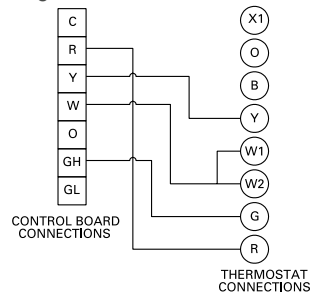
(Molex Housing Spec 396-07V)

**Note:** The following figures show wiring schematics for heat pump and straight cool units with electric heat, respectively.

**Wiring Schematic for Remote Heat Pump**



**Wiring Schematic for Straight Cool Unit.**



## • REMOTE/LOCAL CONTROL

When remote/local switch #1 is on, it allow the unit to operate by the control of Remote Wall Thermostat. The unit control by knobs are not available.

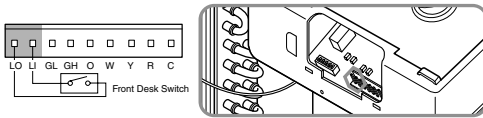
## • ENERGY SAVER

The energy saver switch #2 is on. This switch is set at continuous fan to provide continuous fan operation in cool or heat modes. When the switch is off the continuous fan allows continuous circulation of room air and make the more balanced temperature of the room. When the switch is on the fan is on or off with the compressor or with the heater.

## • FRONT DESK CONTROL

When the pair wire is connected to the connector LO and LI, the unit can be turned ON or OFF with a switch located at the Front Desk Control panel. When the front desk switch is ON, the fan operate according to the condition of setting without working compressor and heater. When the front desk switch is OFF, the unit can operate according to the setting of controls.

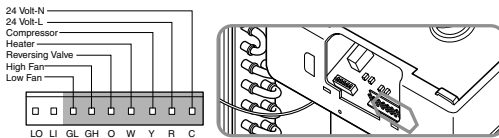
Wire # AWG	Maximum Length
#22	600ft(180m)
#20	900ft(270m)
#18	1500ft(450m)
#16	2000ft(610m)



## • REMOTE WALL THERMOSTAT

When the wires are connected, the unit will be controlled by a remote wall thermostat.

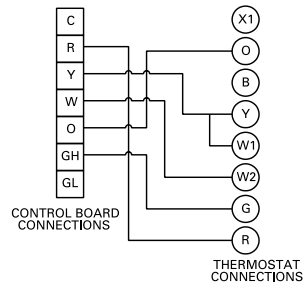
The thermostat connections supply the 24 Volt AC. When you install the digital / electronic thermostat, you must set it to the 24 Volt AC. See the installation Instruction in this manual for the Remote Wall Thermostat.



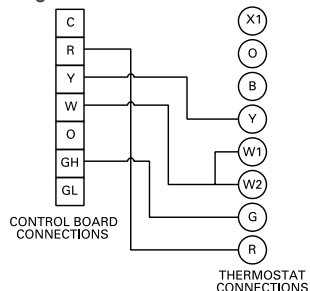
(Molex Housing Spec 396-09V)

**Note:** The following figures show wiring schematics for heat pump and straight cool units with electric heat, respectively.

### Wiring Schematic for Remote Heat Pump



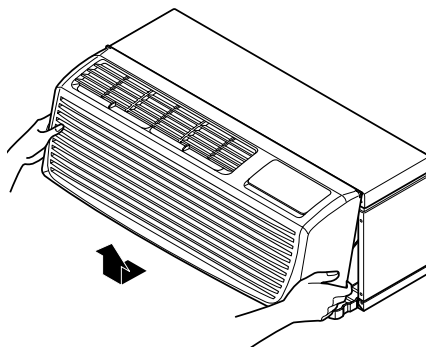
### Wiring Schematic for Straight Cool Unit.



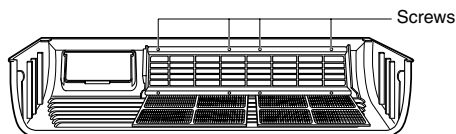
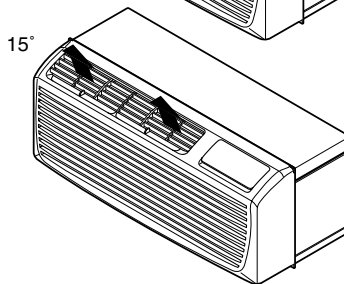
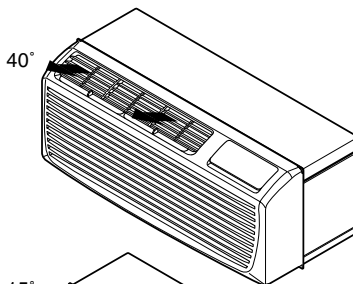
## Disassembly Instructions

- Before the following disassembly, POWER SWITCH is set to OFF and disconnected the power cord.

1. Remove the front grille.
2. To remove the front grille, pull out the bottom of the front grille and then lift up.  
Re-install the component by referring to the removal procedure.
3. To replace the front grille, place the tabs over the top of the unit and push the bottom of front grille until the clips snap into place.



- This Room Air Conditioner (PTAC) discharges air from the top of the unit through reversible, 2-position discharge grille louvers. The unit is shipped from the factory with the discharge grille louvers at an angle of 40° off vertical. In an alternate position the louvers will be at an angle of 15° off vertical.



To adjust the air direction, remove the front grille. Remove the 4 screws that fasten the discharge grille to the front grille.

Flip the discharge grille 180°, then reattach the discharge grille to the front grille with 4 screws.

# Maintenance and Service

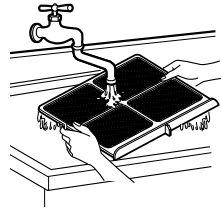
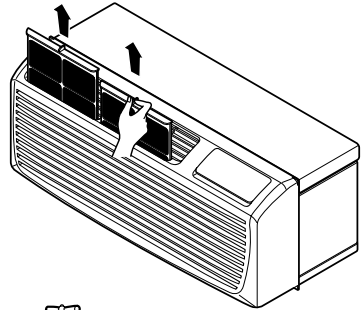
TURN THE AIR CONDITIONER OFF AND REMOVE THE PLUG FROM THE POWER OUTLET.

## Air Filter Cleaning

The air filter should be checked at least twice a month to see if cleaning is necessary. Trapped particles in the filter will build up and block the airflow. This reduces the cooling capacity and also causes an accumulation of frost on the cooling coils.

If the filter becomes torn or damaged you should replace immediately. Replacement filters are available from your salesperson, dealer, and the authorized customer service centers.

1. Remove the air filter from the front grille assembly by pulling the air filter up slightly.
2. Wash the filter using lukewarm water below 104° F(40°C).
3. Gently shake the excess water from the filter completely. Replace the filter.



## Vent Filter

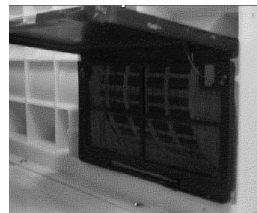
Before cleaning the vent filter, disconnect power to the unit by unplugging the power cord at the wall outlet or subbase, or disconnect power at the fuse box or circuit breaker. If unit is operated with vent door closed, the vent filter does not need to be cleaned.

1. Remove the cabinet front as described in Front Removal.
2. Remove the six screws securing the chassis to the wall sleeve with a Phillips-Head screwdriver.
3. Slide the chassis out of the wall sleeve far enough so that the vent filter is accessible as shown in Figure A.
4. Remove the vent filter by unscrewing the two screws at the top of the filter and gently pulling the filter away from the partition panel. Refer to Figure B.
5. Clean and replace the filter by reattaching the hook to the bottom of the vent door and replacing the two screws, slide the chassis back into the wall sleeve, secure it in place with six screws and reinstall the front cabinet.

Figure A – Vent (Left side of unit)

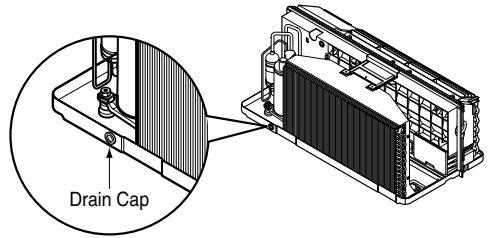


Figure B – Vent Filter Removal



## Drainage

The base pan may overflow due to high humidity. To drain the excess water, remove the drain cap from the back of the unit.



## Chassis

The chassis must be cleaned every four months or more often as the atmospheric conditions require. Use water and detergent to clean the basepan, center partition and coils. The use of harsh cleaning materials may cause a deterioration of the coil fins or endplates. Do not use a high pressure cleaner as it could cause severe damage to the PTAC fins and coils. A hose is okay to use to clean the coils, but make sure to cover the control with a blanket or plastic bag to keep it dry.

Corrosion Resistant units operating in harsh atmospheric conditions must be removed from the sleeve and cleaned every 3 months in the same manner as above.

## Compressor / Fan Motor

The compressor and fan motor are hermetically sealed, permanently lubricated, and require no additional oiling.

## Cabinet Front

The cabinet front and discharge air grille can be cleaned with a mild soap or detergent. Under no circumstances should hydrocarbon based cleaners (e.g. acetone, benzene, naphtha, gasoline, etc.) be used to clean the front or air grilles.

Use care when cleaning the control area. Do not use an excessively wet cleaning cloth.

## Corrosion Resistant Models

Corrosion resistant models subjected to harsh seacoast environments must be removed from the wall sleeve and completely flushed with clean water at least four times a year. The basepan, center partition, condenser end plates, and the condenser itself should be sprayed with clean, fresh water. Leaving the unit in the sleeve and simply spraying the outdoor grille is not sufficient.

## Common Problems and Solutions

*Troubleshooting Tips save time and money!*

*Review the chart below first and you may not need to call for service.*

### Normal Operation

- You may hear a pinging noise caused by water being picked up and thrown by the slinger fan against the condenser on rainy days or when the humidity is high. This design feature helps remove moisture and improve efficiency.
- You may hear the thermostat click when the compressor cycles on and off.
- Water will collect in the base pan during high humidity or on rainy days. The water may overflow and drip from the outdoor side of the unit.
- The fan may run even when the compressor does not.

### Troubleshooting

COMPLAINT	CAUSE	REMEDY
<b>Fan motor will not run.</b>	■ No power	• Check voltage at outlet. Correct if none.
	■ Power supply cord	• Check voltage to rotary switch. If none, check power supply cord. Replace cord if circuit is open.
	■ Rotary switch	• Check switch continuity. Refer to wiring diagram for terminal identification. Replace switch if defective.
	■ Wire disconnected or connection loose	• Connect wire. Refer to wiring diagram for terminal identification. Repair or replace loose terminal.
	■ Capacitor (Discharge capacitor before testing)	• Test capacitor. Replace if not within $\pm 10\%$ of manufacturer's rating. Replace if shorted, open, or damaged.
<b>Fan motor runs intermittently.</b>	■ Will not rotate	• Fan blade hitting shroud or cross flow fan hitting scroll. Realign assembly.  • Units using slinger ring condenser fans must have $\frac{1}{4}$ to $\frac{5}{16}$ inch clearance to the base. If it is hitting the base, shim up the bottom of the fan motor with mounting screw(s).  • Check fan motor bearings; if motor shaft will not rotate, replace the motor.
	■ Revolves on overload	• Check voltage. See limits on this page. If not within limits, call an electrician.  • Test capacitor. Check bearings. Does the fan blade rotate freely? If not, replace fan motor.  • Pay attention to any change from high speed to low speed. If the speed does not change, replace the motor.

COMPLAINT	CAUSE	REMEDY
<b>Fan motor noise.</b>	■ Grommets	• Check grommets; if worn or missing, replace them.
	■ Fan	• If cracked, out of balance, or partially missing, replace it.
	■ Loose set screw	• Tighten it.
	■ Worn bearings	• If knocking sounds continue when running or loose, replace the motor. If the motor hums or noise appears to be internal while running, replace motor.
<b>Compressor will not run, but fan motor runs.</b>	■ Voltage	• Check voltage. See the voltage limits. If not within limits, call an electrician.
	■ Wiring	• Check the wire connections, if loose, repair or replace the terminal. If wires are off, refer to wiring diagram for identification, and replace. Check wire locations. If not per wiring diagram, correct.
	■ Rotary	• Check for continuity, refer to the wiring diagram for terminal identification. Replace the switch if circuit is open.
	■ Thermostat	• Check the position of knob. If not at the coldest setting, advance the knob to this setting and restart unit. Check continuity of the thermostat. Replace thermostat if circuit is open.
	■ Capacitor (Discharge capacitor before servicing)	• Check the capacitor. Replace if not within $\pm 10\%$ of manufacturer's rating. Replace if shorted, open, or damaged.
	■ Compressor	• Check the compressor for open circuit or ground. If open or grounded, replace the compressor.
	■ Overload	• Check the compressor overload, if externally mounted. Replace if open. (If the compressor temperature is high, remove the overload, cool it, and retest.)
■ Pressure Switch	• Check continuity of the pressure switch. Replace the pressure switch if circuit is open.	



COMPLAINT	CAUSE	REMEDY
<b>Compressor cycles on overload.</b>	■ Voltage	• Check the voltage. See the limits on the preceding page. If not within limits, call an electrician.
	■ Overload	• Check overload, if externally mounted. Replace if open. (If the compressor temperature is high, remove the overload, cool, and retest.)
	■ Fan motor	• If not running, determine the cause. Replace if required.
	■ Condenser air flow restriction	• Remove the cabinet. inspect the interior surface of the condenser; if restricted, clean carefully with a vacuum cleaner (do not damage fins) or brush. Clean the interior base before reassembling.
	■ Condenser fins (damaged)	• If condenser fins are closed over a large area on the coil surface, head pressures will increase, causing the compressor to cycle. Straighten the fins or replace the coil.
	■ Capacitor	• Test capacitor.
	■ Wiring	• Check the terminals. If loose, repair or replace.
	■ Refrigerating system	• Check the system for a restriction.
<b>Insufficient cooling or heating.</b>	■ Air filter	• If restricted, clean or replace.
	■ Exhaust damper door	• Close if open.
	■ Unit undersized	• Determine if the unit is properly sized for the area to be cooled.
<b>Excessive noise.</b>	■ Cross flow fan	• Check the set screw or clamp. If loose or missing, correct. If the blower or fan is hitting air guide, rearrange the air handling parts.
	■ Copper tubing	• Carefully rearrange tubing not to contact, compressor, shroud, and barrier.

## ROOM AIR CONDITIONER VOLTAGE LIMITS

NAME PLATE RATING	MINIMUM	MAXIMUM
208/230 V	187 V	253 V
265 V	239 V	292 V

## **GARANTIE LIMITÉE**

Si le produit présente un défaut de matériaux ou de fabrication dans des conditions d'utilisation normales pendant la période de garantie indiquée ci-dessous, laquelle période de garantie est en vigueur à partir de la date d'achat d'origine, LG Electronics réparera ou remplacera, à sa discrétion, le produit sans frais.

La garantie est valide seulement pour l'acheteur d'origine du produit, pendant la période de garantie, tant et aussi longtemps que cela soit au Canada.

### **Période de garantie du climatiseur LG**

<b><u>Composant</u></b>	<b><u>Pièces</u></b>	<b><u>Main-d'oeuvre</u></b>
Toutes les pièces	5 ans	1 ans (service à domicile)
Compresseur	5 ans	5 ans (service à domicile)

Aucune autre garantie n'est applicable à ce produit. LA DURÉE DE TOUTE GARANTIE IMPLICITE, INCLUANT LA GARANTIE IMPLICITE DE COMMERCIALISATION, EST LIMITÉE À LA DURÉE DE LA GARANTIE EXPRESSE INDIQUÉE CI-APRÈS. LG ELECTRONICS NE PEUT ÊTRE TENUE RESPONSABLE POUR LA PERTE D'UTILISATION DE CE PRODUIT, INCONVÉNIENT, PERTE OU TOUT AUTRE DOMMAGE, DIRECT OU INDIRECTS, SURVENANT À LA SUITE DE L'UTILISATION OU DE L'INHABILITÉ À UTILISER LE PRODUIT OU POUR TOUT BRIS DE GARANTIE IMPLICITE OU EXPRESSE, INCLUANT LA GARANTIE IMPLICITE DE COMMERCIALISATION OU À DES FINS PARTICULIÈRES, APPLICABLES À CE PRODUIT.

Certaines provinces ou territoires ne permettent pas l'exclusion ou la limitation de dommages indirects ou accessoires de limitation sur la durée d'une garantie implicite, par conséquent, ces limitations peuvent ne pas s'appliquer.

Cette garantie vous (l'acheteur d'origine) donne des droits spécifiques légaux et vous pouvez en avoir d'autres qui varient d'une province ou territoire à un autre.

### **LA GARANTIE SUSMENTIONNÉE NE S'APPLIQUE PAS :**

1. Au déplacement de service à domicile pour livrer ou cueillir, installer, instruire ou remplacer un fusible ou rebrancher le câblage résidentiel ou la plomberie ou corriger une réparation non autorisée.
2. Aux dommages au produit causés par accident, vermine, incendie, inondation ou actes de Dieu.
3. Aux réparations lorsque le produit LG est utilisé à des fins autres que normales, utilisation résidentielle unifamiliale ou contraire aux instructions données dans le guide du propriétaire du produit.
4. Aux dommages résultant d'accident, modification, mauvaise utilisation, abus ou installation ou entretien inadéquat.
5. Aux produits modifiés ou dont le numéro de série a été enlevé.

Si le produit est installé à l'extérieur de la zone de service normale, tous frais de déplacement nécessaire pour la réparation du produit, ou le remplacement d'une pièce défectueuse seront imputés au propriétaire.

### **INFORMATION D'AIDE À LA CLIENTÈLE :**

**Pour obtenir une garantie :** Conserver la facture comme preuve de la date d'achat.  
Une copie de la facture doit être présentée lorsqu'un service sous garantie est fourni.  
Cette garantie n'est pas valide si le numéro de série apposé en usine a été modifié ou enlevé du produit.

**Pour obtenir de l'aide sur le  
ou pour le service à la clientèle :** Téléphoner au 1-888-LG-CANADA (542-2623)  
Presser l'option du menu approprié, et avoir les numéros de modèle et de série et votre code postal sous la main.

**Pour obtenir le centre de  
service autorisé le plus près :** Aller au site web : [www.LG.ca](http://www.LG.ca) (option service) ou téléphoner au 1-888-LG-CANADA (542-2623)  
Presser l'option du menu approprié, et avoir les numéros de modèle et de série et votre code postal sous la main.

**LG ELECTRONICS, INC.**  
**LG Packaged Terminal Air Conditioner Limited Warranty - USA**

Should your LG Packaged Terminal Air Conditioner prove to be defective in materials or workmanship under normal use during the warranty period listed below, LG Electronics will replace the defective part(s). Replacement part(s) will meet intended fit and function of the original part(s). Replacement parts are warranted for the unexpired portion of the original warranty period. This warranty is good only to the original purchaser of the product and effective only when used in the United States.

**WARRANTY PERIOD:**

For The Period Of:	LGE Will Replace:
<b>One Year</b> From the date of the original purchase	<b>Any part of LGE Packaged Terminal</b> which fails due to a defect in materials or workmanship. During this <b>full one-year warranty</b> , LGE will also provide, <b>free of charge</b> , all labor and on-site service to replace the defective part.
<b>Five Years</b> From the date of the original purchase	<b>Any part of the sealed refrigerating system</b> (the compressor, condenser, evaporator and all connecting tubing) which fails due to a defect in materials or workmanship. During this <b>full five-year sealed refrigerating system warranty</b> , LGE will also provide, free of charge, all labor and on-site service to replace the defective part.
<b>Five Years</b> From the date of the original purchase	For the <b>second through the fifth year</b> from the date of original purchase, LGE will replace <b>certain parts</b> that fail due to a defect in materials or workmanship. Parts covered are fan motors, switches, thermostats, heater, heater protectors, compressor overload, solenoids, circuit boards, auxiliary controls, thermistors, frost controls, ICR pump, capacitors, varistors and indoor blower bearing. During this <b>limited four-year parts warranty</b> , you will be responsible for any labor or on-site service costs.

**No other warranty is applicable to this product. THIS WARRANTY IS IN LIEU OF ANY OTHER WARRANTY, EXPRESS OR IMPLIED, INCLUDING WITHOUT LIMITATION, ANY WARRANTY OF MERCHANTABILITY OR FITNESS FOR A PARTICULAR PURPOSE. TO THE EXTENT ANY IMPLIED WARRANTY IS REQUIRED BY LAW, IT IS LIMITED IN DURATION TO THE EXPRESS WARRANTY PERIOD ABOVE. NEITHER THE MANUFACTURER NOR ITS U.S. DISTRIBUTOR SHALL BE LIABLE FOR ANY INCIDENTAL, CONSEQUENTIAL, INDIRECT, SPECIAL, OR PUNITIVE DAMAGES OF ANY NATURE, INCLUDING WITHOUT LIMITATION, LOST REVENUES OR PROFITS, OR ANY OTHER DAMAGE WHETHER BASED IN CONTRACT, TORT, OR OTHERWISE. Some states and/or territories do not allow the exclusion or limitation of incidental or consequential damages or limitations on how long an implied warranty lasts, so the above exclusion or limitation may not apply to you. This warranty gives you, the original purchaser, specific legal rights and you may also have other rights that vary from state to state or territory to territory.**

**THIS LIMITED WARRANTY DOES NOT APPLY TO:**

1. Service trips to your home for delivery or pickup, install, instruct or replace house fuses, or connect house wiring or plumbing, or correction of unauthorized repairs.
2. Failure of product to perform during power failures and interruptions or inadequate electrical service.
3. Damage caused by transportation or handling.
4. Damage to the product caused by accident, vermin, lightning, winds, fire, floods, or acts of God.
5. Damages caused by leaky or broken water pipes, frozen water pipes, restricted drain lines, or inadequate or interrupted water supply.
6. Damages cause by inadequate supply of air.
7. Damages resulting from running the product in a corrosive atmosphere.
8. Damage resulting from accident, misuse, abuse, or improper installation, repair, or maintenance. Improper repair includes use of parts not approved or specified by LG.
9. Normal maintenance as described in the installation instructions and use and care manual, such as replacing filters, cleaning of coils, etc.
10. Use of accessories or components that are not compatible with this product.
11. Products with altered or removed serial numbers.
12. Changes in the appearance of the product that do not affect product performance.
13. Increases in utility costs and additional utility expenses.

**The cost of repair or replacement under these excluded circumstances shall be borne by the consumer.**