

This Owner's Manual is provided and hosted by [Appliance Factory Parts](#).



# MIDEA MWF1-25CR Owner's Manual

[Shop genuine replacement parts for MIDEA  
MWF1-25CR](#)



[Find Your MIDEA Air Conditioner Parts - Select From 1120 Models](#)

----- Manual continues below -----

# PORTABLE AIR CONDITIONER

## INSTRUCTION MANUAL

Read Rules for Safe Operation and Instructions Carefully.

## Table Of Contents

	Page
Electrical and Unit Specifications .....	3
Energy-Saving Tips .....	4
Window Installation .....	4
Operating Instructions .....	5
Care and Maintenance .....	19

### NAMES OF PARTS

**Model: MPA-08CR, MPA-08ER**

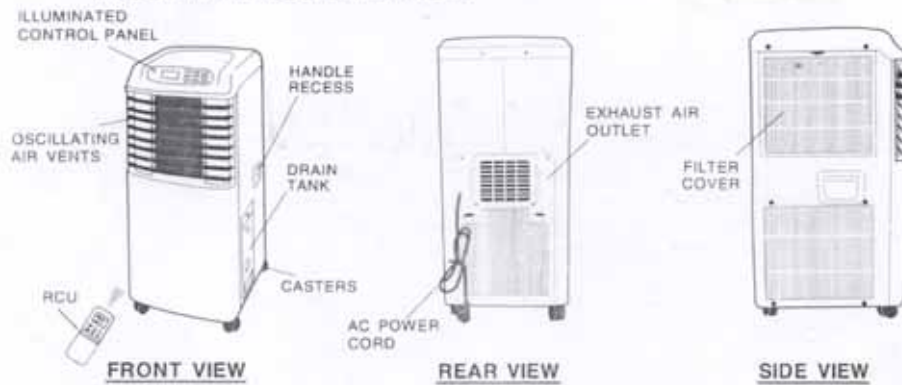

**A Style**

**B Style**

**C Style**

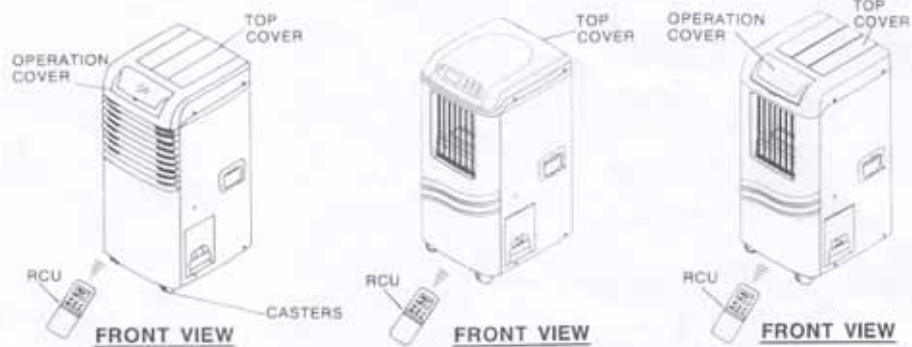

**Note:** The Rear View and Side view as well as the performance of above models are same as that of Model MPA-08CR and MPA-08ER.



**CAUTION**



Do not leave this unit unattended in a space where people or animals who cannot react to a failed unit are located. A failed unit can cause extreme overheating or death in such an enclosed, unattended space.

## Electrical Specifications

1. All wiring must comply with local and national electrical codes and be installed by a qualified electrician. If you have any questions regarding the following instructions, contact a qualified electrician.
2. Check available power supply and resolve any wiring problems BEFORE installation and operation of this unit.
3. This unit draws 7.4 amps (nameplate rated) under **Cooling mode** and 12.0 amps (nameplate rated) under **Heating Mode** and may be used in any properly wired, general purpose 15 amp household grounded receptacle.
4. For your safety and protection, this unit is grounded through the power cord plug when plugged into a matching wall outlet. If you are not sure whether the wall outlets in your home are properly grounded, please consult a qualified electrician. **DO NOT USE PLUG ADAPTERS OR EXTENSION CORDS.**
5. The manufacturer's nameplate is located on the rear panel of the unit and contains electrical and other technical data specific to this unit.

6. To avoid the possibility of personal injury, always disconnect the power supply to the unit, before installing and/or servicing.

<b>Table 1</b>	
<b>Suggested Individual Branch Circuit</b>	
Nameplate Amps 7.4 to 12.0	AWG Wire Size* 14
AWG-American Wire Gage *Based on copper wire at 60°C temperature rating.	

<b>Table 2</b>	
<b>Receptacle and Fuse Types</b>	
Rated Volts	125
Amps	15
Wall Outlet	
Fuse Size	
Time Delay Fuse (or circuit breaker)	Plug Type

<b>Unit Specifications:</b>	Cooling Only Models	Heating/Cooling Models
Cooling Capacity	7200 Btu/h	7500 Btu/h
Heating Capacity	Not Applicable	1500W/1000W
Dehumidifying Capacity	52 Pints (24.6L/24Hrs)	52 Pints (24.6L/24Hrs)
Noise Level	Less than 54 dB(A)	Less than 54 dB(A)
Power Source	115V / 60Hz	115V / 60Hz
Refrigerant	R22	R22
Water Tank Capacity	5.5L(11.6Pints)	5.5L(11.6Pints)
Unit Weight	38kg(83.7 lb.)	38kg(83.7 lb.)
Unit Dimensions(inches)W×D×H	15 <sup>1</sup> / <sub>4</sub> "×18"×32 <sup>5</sup> / <sub>8</sub> "	15 <sup>1</sup> / <sub>4</sub> "×18"×32 <sup>5</sup> / <sub>8</sub> "
Unit Dimensions(cm)W×D×H	38.7×45.6×82.9	38.7×45.6×82.9
Fan speeds	3	3
Control Panel(Illuminated)	Soft Touch Controls	Soft Touch Controls
Time of Day Clock	Yes	Yes
Auto - Timer	Yes	Yes
<b>Power Consumption:</b>		
Cooling	851Watts(7.4 Amps)	851Watts(7.4 Amps)
Heating	Not Applicable	1500Watts(High) 12.0 Amps 1000Watts(Low)10.4 Amps
Dehumidifying	850W (7.4 Amps)	850W (7.4 Amps)
Fan	90W(0.8Amps)	90W(0.8Amps)

NOTE: Specifications are subject to change without notice, for further improvements.

## Energy-Saving Tips

This appliance is designed to be highly efficient in energy savings. Follow these recommendations for greater efficiency.

- 1) Select a thermostat setting that suits your comfort needs and leave at that chosen setting.
- 2) The air filter is very efficient in removing airborne particles. Keep the air filter clean at all times.
- 3) Use drapes, curtains or shades to keep direct sunlight from penetrating and heating room, but do not allow drapes or curtains to obstruct the air flow around the unit.

- 4) Start your air conditioner before the outdoor air becomes hot and uncomfortable. This avoids an initial period of discomfort while the unit is cooling off the room. Use of the automatic start/stop programmable **TIMER** feature can be a major asset in this regard if utilized to the fullest extent.
- 5) When outdoor temperatures are cool enough, turn the air conditioner off and use the **FAN MODE** on **HIGH, MED** or **LOW**. This circulates indoor air, providing some cooling comfort and utilizes less electricity.

## Window Installation



### Electric Shock Hazard

To avoid the possibility of personal injury, disconnect power to the unit before installing or servicing.



### CAUTION



To avoid installation/operation difficulties, read these instructions thoroughly.

The exhaust/window kit must be installed at all times when the unit is operating under the **AIR CONDITIONING** mode.

There should be at least 11.8"(30 cm) clearance between the unit and any other other objects or building structure. The unit should be installed on a level surface. The window kit does not have to be installed during operation of the remaining three modes. (Heating/Dehumidifying/Fan).

### Installation Accessories Fig.1

Description	Quantity
<b>Flexible exhaust hose with adapters</b> .....	3/set
stretches from 19 <sup>1</sup> / <sub>2</sub> " (50cm) up to 78 <sup>3</sup> / <sub>4</sub> " (200cm)	
<b>Window exhaust adapter</b> (flat mouth).....	1Pc
<b>Adjustable window/patio door slider kit</b> .....	2/set
from 26 <sup>5</sup> / <sub>8</sub> " (67.5cm) up to 48 <sup>3</sup> / <sub>8</sub> "(203cm)	
<b>Drain hose connector</b> .....	1 Pc
continuous drain option (hose not included)	
<b>SPECIAL NOTE:</b> Exterior drain hose extension (direct drain) is not included with this unit and can be purchased through any local Hardware Store.	

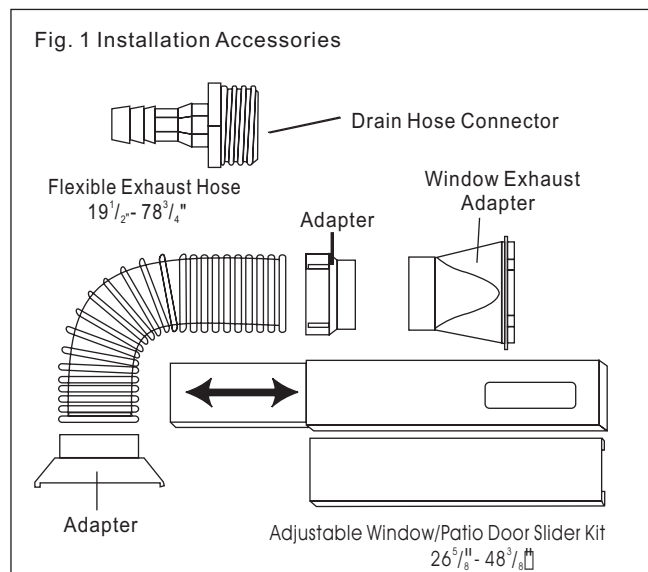

## Window Kit Installation

Your window kit has been designed to fit most standard "vertical" and "horizontal" window applications. However, **it may be necessary for you to improvise/modify some aspects of the installation procedures for certain types of windows.** Please refer to Fig. 2 & Fig. 2a for minimum and maximum window openings.

## Water Tank Safety Feature

This unit is equipped with a fail-safe switch mechanism which prevents the unit from condensing water in the event the water tank is accidentally displaced, and/or **FULL** with water. If this situation occurs, the unit will signal **8 BEEPS** and the **WATER FULL** indicator light will flash red continuously until the water tank is correctly positioned and/or emptied.

**NOTE: The fan motor will continue to operate under this condition. This is normal, but no cooling or dehumidifying will occur until the tank is emptied and/or correctly installed (It may take several minutes before the compressor resumes normal operation).**

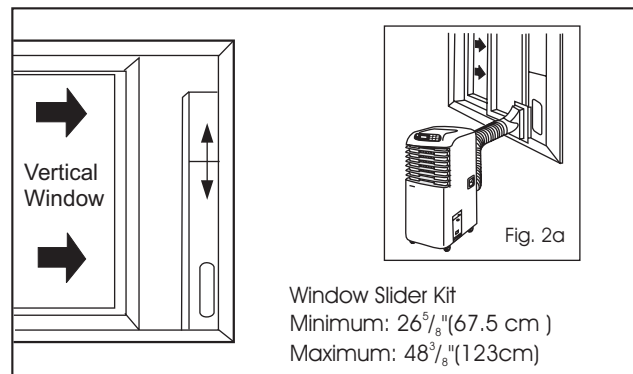
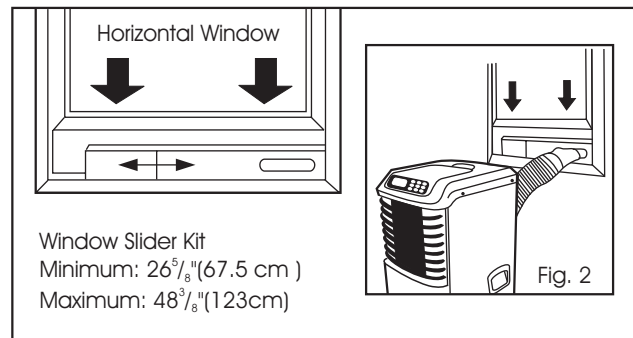

## Window Installation

### Before Starting This Unit

- 1) Select a suitable location, making sure you have easy access to an electrical outlet.
- 2) Install the **Flexible Exhaust Hose** and the **Adjustable Window Slider Kit** as depicted in Fig. 3 & Fig. 3a.

**NOTE: Step 2 is required only while using the AIR CONDITIONER MODE**

- 3) Plug the unit into a 115V/60Hz grounded electrical outlet.

**DO NOT USE AN EXTENSION CORD.**

- 4) Make sure the **Water Tank** is correctly positioned inside the cabinet otherwise the unit will not operate. Fig 4.
- 5) To turn the unit on, press the **I/O** key (On/ Off Switch).

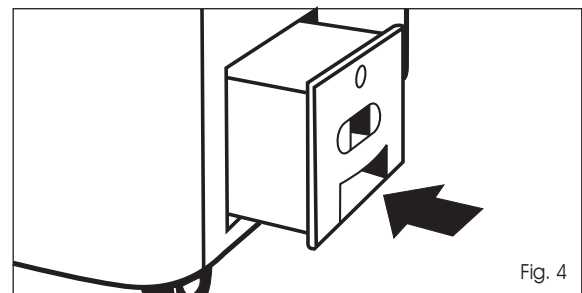
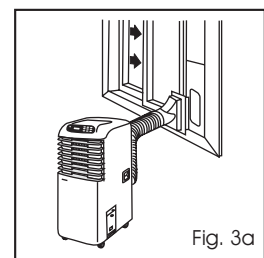
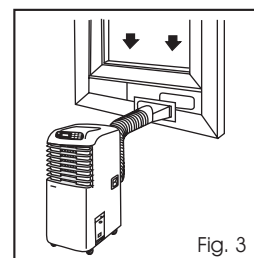

**Key Pad Functions Fig.5**

**I/O:** Power On/Off.

**MODE:** Selects the appropriate operating mode.

**Cool-Heat-Dry (Dehumidifier)-Fan.**

**Note:**"Heat Mode" is for Heating/Cooling Model only .

**MODE Indicator Lights:** Illuminates under the different mode settings Fig.6;

**COOL Mode:** Green Light

**HEAT Mode:** Red light

**DRY(Dehumidifier)Mode:** Green Light

**FAN Mode:** No indicator light

**Green Light :** Remains on while compressor is operating. Green light turns off when desired temperature is achieved. **Applicable to both**

**Air Conditioner and Dehumidifier.**

**Red Light:** Remains on while heater is operating. Red light turns off when desired temperature is achieved.

**Water Full Indicator Light:** Flashes red when the water level of the water tank exceeds the maximum set level or if the water tank is not correctly positioned in the cabinet. Fig.7.

**FAN:** Selects High-Medium-Low fan speeds

**Fan Options:**

Cooling (3 speeds) **High-Medium-LOW.**

Heating (2 speeds) **High-Low.**

Dry-Dehumidifying (1 speed) **Medium.**

Fan (3 speeds) **High-Medium-Low.**

△ : Used to adjust (forward ) Time of Day Clock settings (1min, increments).

Used to adjust (forward) Temperature settings (1°C increments).

Used to adjust (forward) Auto-Timer of settings (10 min. increments)

▽ : Used to adjust (backward ) Time of Day Clock settings (1min, increments).

Used to adjust (backward) Temperature settings (1°C increments).

Used to adjust (backward) Auto-Timer of settings (10 min. increments)

**SWING:** Allows the vertical louver grills to oscillate back and forth automatically(70° Swing).

**CLOCK:** Allows you to initiate and/or change the **TIME OF DAY** setting.

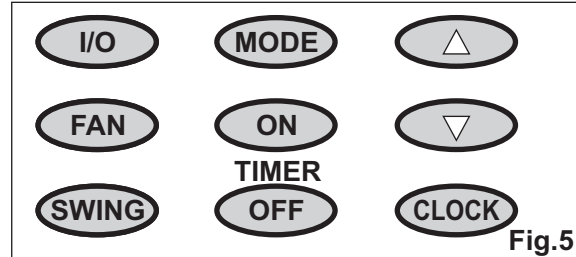

**Fig.5**

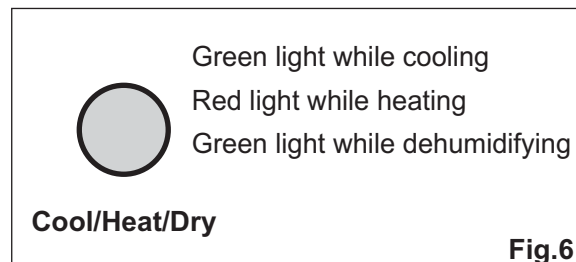

**Fig.6**

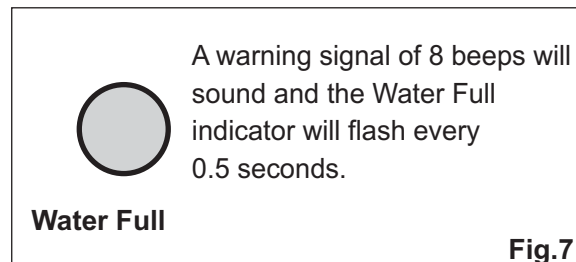

**Fig.7**

Temperature Conversion Chart	
°C	10 11 12 13 14 15 16 17 18 19 20 21
°F	50 52 54 55 57 59 61 63 64 66 68 70
°C	22 23 24 25 26 27 28 29 30 31 32 33
°F	72 73 75 77 79 81 82 84 86 88 90 91

**TIMER ON:** Used to initiate the AUTO ON start time program, in conjunction with the △ & ▽ key pads

**TIMER OFF:** Used to initiate the **AUTO OFF** stop time program, in conjunction with the △ & ▽ key pads.

### Setting TIME OF DAY (Clock) Instructions:

1) Push and hold the **CLOCK** key pad for three(3) seconds. The clock display will flash indicating "12.00" for approximately 10 seconds.

Fig.8.

2) Push either the  $\Delta$  or  $\nabla$  key pad, to enter the correct time of day. Each depression of the key pad will increase or decrease the time of day setting (1 minute increments). Fig. 9.

3) When the correct time of day has been established in the display window, push the **CLOCK** key pad again to activate the **TIME OF DAY** clock setting. The "colons" between the **TIME OF DAY** will start to flash indicating the clock is operational.

**Important Note:** Any interruption to the electrical power supply will automatically cancel the **TIME OF DAY** clock program. In the event this should happen, you will be required to re-set the clock program.

### Air Conditioner Operating Instructions

1) Install the **Flexible Exhaust Hose** Fig.10 and the **Adjustable Window/Patio Door Slider Kit** as depicted in Fig.2,2a & 2b (pg.5)

2) Press the I/O (on/off) key pad to switch on the unit.

3) Press the **MODE** key until the word **COOL** is displayed in the **LCD (Liquid Crystal Display)** window. Fig.12. Each depression of the **MODE** key will advance to a different mode setting (**Cool-Heat-Dry-Fan**).

**Note:** Heat is for Heating/Cooling Model only.

4) Press the appropriate  $\Delta$  or  $\nabla$  key to select a suitable temperature setting. The temperature selected will be indicated in the **LCD (Liquid Crystal Display)** window.

Temperature settings are adjustable between 17°C(63°F)to 30°C(86°F). Fig.13.

The green indicator light will come on indicating the air-conditioning mode is operational (there may be a slight delay of 10-30 seconds before the cycle begins, this is normal).

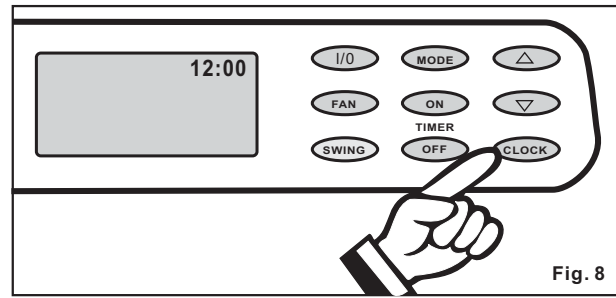

Fig. 8

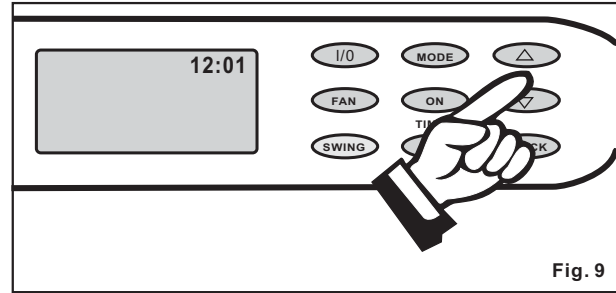

Fig. 9

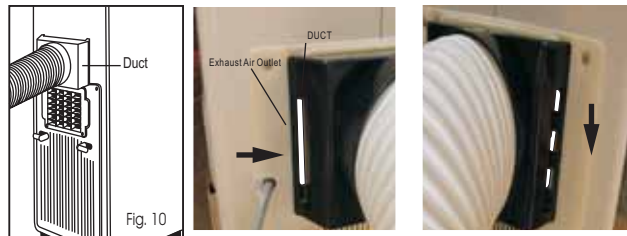

Fig. 10

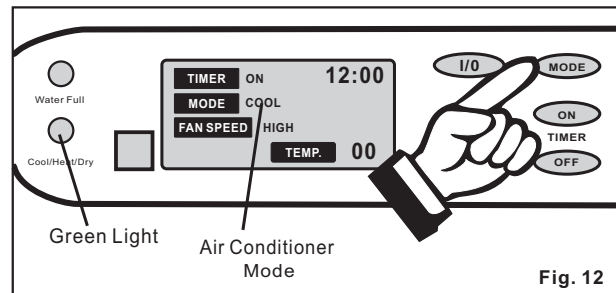

Fig. 12

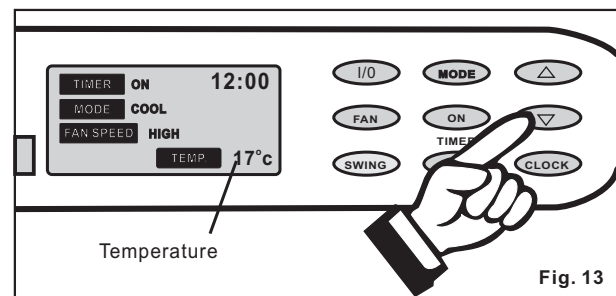

Fig. 13

## Air Conditioner Operating Instructions (cont'd)

- 5) Press the **FAN** key to select the desired fan speed setting (**High-Med-Low**). See Fig.14. Your selection will be displayed in the **LCD** window (each depression of the fan key will advance to a different setting).
- 6) Press the **SWING** key to activate the automatic air swing (oscillating )feature (the "air swing" symbol will appear in the **LCD** window ). Fig. 15. To deactivate the air swing feature, press the **SWING** key again.
- 7) Condensed water will be accumulated in the water tank. When the tank is full, the unit will sound a signal (**8 beeps**) and the **Water Full** indicator light start flashing. At this time the air conditioning process will immediately stop However , the fan motor will continue to operate (this is normal ). Carefully remove the water tank from the cabinet and dispose of the water . Replace the water tank back to it's original position (in cabinet) and the air conditioning process will automatically resume. It may take 3-5 minutes for the compressor to re-start . This is normal.
- 8) To adjust "air flow" direction , (up / down only ) adjust any one of the **Horizontal Louver Blades (excluding the top or bottom louver)** and the remaining louvers will automatically adjust to the set position (**excluding the top and/or bottom louvers**). Fig.16.

Cooling stops automatically when the set temperature is achieved. Cooling resumes when the room temperature rises above the set temperature level. The temperature has no effect on the fan operation. Therefore, the fan will operate continuously (after the compressor has cycled off) to maintain optimal temperature control.

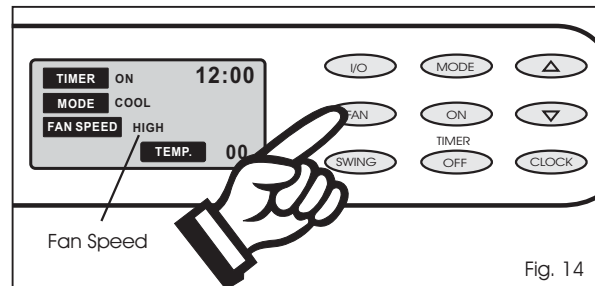

Fig. 14

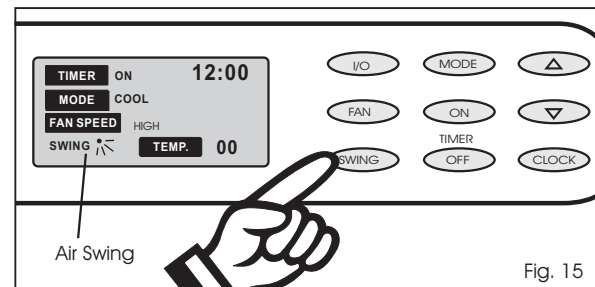

Fig. 15

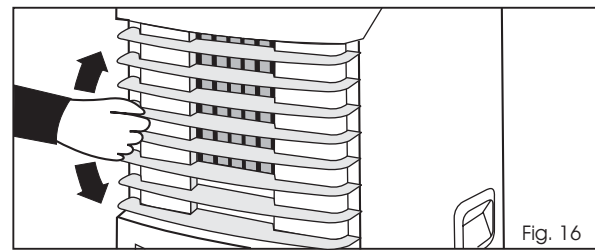

Fig. 16



### CAUTION



During air conditioning and dehumidifying modes, if the compressor cycle is interrupted (unplugged, power failure, etc.) And reinstated immediately thereafter.(within 3-5 minutes.) A "compressor protection circuit" is automatically self-affected. The mode indicator light will flash "green" for approximately 10 seconds, confirming the protection circuit is activated. The compressor cannot operate during a "compressor protecton" condition.(this is normal)It may take 3-5 minutes before the "protection circuit" self-deactivates.

**DO NOT ATTEMPT TO START THE UNIT (COMPRESSOR) DURING THIS PERIOD.**



### ATTENTION



Removal and/or partial displacement of the water tank will cause the compressor to stop operating (this is a safety feature). This condition will cause the unit to "beep 8"times"and the "water full"light will flash (**red**)continuously until corrected. **The compressor cannot operate during a flashing "red" light condition.** Check the following;

1. Is the water tank full?  
Empty and re-install water tank.
2. Has the water tank been accidentally displaced?  
Re-Position water tank.

The "red" light will stop flashing automatically When the water tank has been emptied and/or correctly re-positioned.

## DRY (Dehumidifier ) Operating Instructions

- 1) Press the **I/O** ( on/off) key pad to switch on the unit.
- 2) Press the **MODE** key until the word **DRY** (Dehumidifying) is displayed in the **LCD** display window. Fig.17. Each depression of the **MODE** key will advance to a different mode setting (**Cool - Heat - Dry - Fan**)
- 3) Press the appropriate  $\triangle$  or  $\nabla$  key to set a dehumidifying temperature between 10°C(50°F) to 30°C(86°F). Fig. 18. The **green** indicator light will come on indicating the dehumidifying mode is operational (there may be a slight delay of 10-30 seconds before the cycle begins, this is normal).

**IMPORTANT:** The temperature selected should always be set a few degrees lower than the room ambient temperature ,to ensure normal dehumidifying operation. However, **it is not recommended to operate your Dehumidifier, below temperatures of 15.5°C(60°F)**, this could result in icing-up conditions of the evaporator coils, minimizing efficiency. Under the dehumidifying mode, you cannot select a fan speed. The fan motor operates at a pre-set speed, which registers as **MED** in the **LCD** window.
- 4) Condensed water will be accumulated in the water tank. When the tank is full , the unit will sound a signal(**8 beeps**) and the **Water Full** indicator light start flashing. At this time the dehumidification process will immediately stop. However, the fan motor will continue to operate (this is normal). Carefully remove the water tank from the cabinet and dispose of the water. Replace the water tank back to it's original position (in cabinet) and the Dehumidifying process will automatically resume. It may take 3-5 minutes for the compressor to re-start. This is normal.
- 5) This unit also has provisions for a continuous "drain" option (for basement applications having a floor drain). The required drain hose extension is not included with this unit. It can be purchased through any local Hardware Store. Drain Hose Specifications: Standard garden hose.

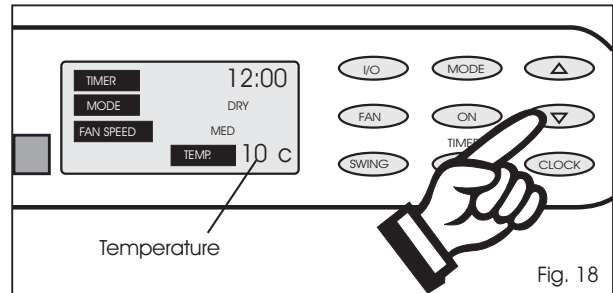
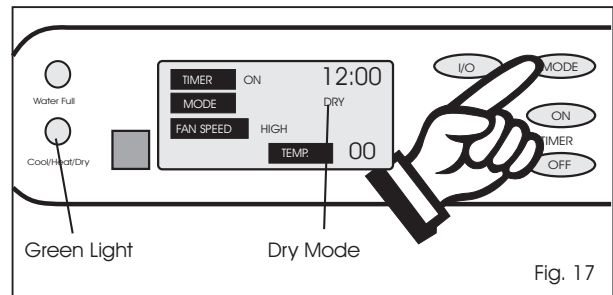

**DRY( Dehumidifier) Operating Instructions (cont'd)**

6) To connect the continuous drain option. Remove the water tank from the cabinet. Inside the cabinet (water tank area) you will find a section of hose hanging beside the water tank, which is **plugged/capped** at the end. Remove the **plug** from the end of the hose and install the **drain hose connector** (included with this unit) into the end of this hose section. Route the end of the hose (with drain connection) into the water tank, then through the hole provided in the face of the water tank. Attach a section of **Garden Hose** (to suit your continuous drain option requirements) to the drain hose connector. Place the open end of the hose directly over the drain area in your basement floor. Fig. 19.

**IMPORTANT:** Please make sure the drain hose section routed through water tank does not interfere with the correct positioning of the water tank inside the cabinet, or the **fail-safe switch mechanism** will be activated, not allowing the unit to operate.

7) You must remember to **reverse** the continuous drain option procedure **re-cap/plug** the **internal drain hose** and/or leave **the internal drain hose** (unplugged) inside the water tank, when re-locating your unit to a location(room) where continuous draining is not possible. **Failure to comply with these procedures will result in flooding.**

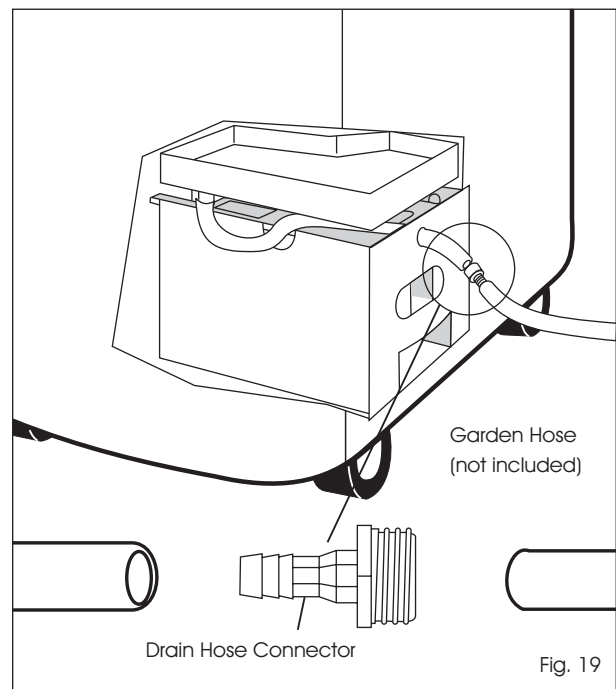

**CAUTION**

During air conditioning and dehumidifying modes, if the compressor cycle is interrupted (unplugged, power failure, etc.) And reinstated immediately thereafter, (within 3-5 minutes.) A "compressor protection circuit" is automatically self-affected. The mode indicator light will flash "green" for approximately 10 seconds, confirming the protection circuit is activated. The compressor cannot operate during a "compressor protecton" condition. (this is normal) It may take 3-5 minutes before the "protection circuit" self-deactivates.

**DO NOT ATTEMPT TO START THE UNIT (COMPRESSOR) DURING THIS PERIOD.**

**ATTENTION**

Removal and/or partial displacement of the water tank will cause the compressor to stop operating (this is a safety feature). This condition will cause the unit to "beep 8"times" and the "water full" light will flash (**red**) continuously until corrected. **The compressor cannot operate during a flashing "red" light condition.** Check the following;

1. Is the water tank full?  
Empty and re-install water tank.
2. Has the water tank been accidentally displaced?  
Re-Position water tank.

The "red" light will stop flashing automatically When the water tank has been emptied and/or correctly re-positioned.

## Heater Operating Instructions(For Heating/Cooling Models Only)

1) Press the **MODE** key until the word Heat is displayed in the **LCD** window. Fig.20. Each depression of the **MODE** key will advance to a different mode setting (**Cool-Heat-Dry Fan**). The red indicator light will come on indicating the "Heating "mode is operational (there may be a slight delay of 5-10 seconds before the cycle begins, this is normal).

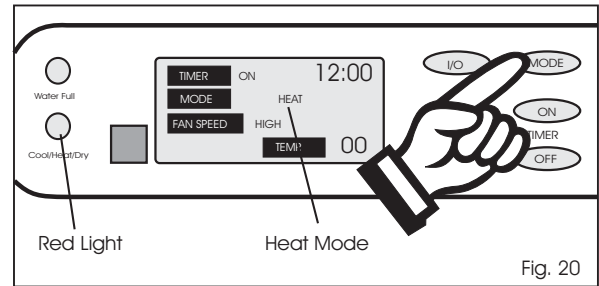

2) Press the appropriate  $\triangle$  or  $\nabla$  key to select a suitable temperature between 17°C (63°F) to 30°C (86°F). Fig.21.

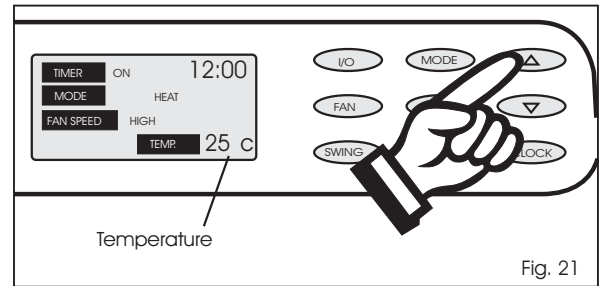

3) Press the **FAN** key to select the desired fan speed setting (**High-Low**). Your selection will be displayed in the **LCD** window. Each depression of the fan key will alternate between the different fan speed settings. Fig.22.

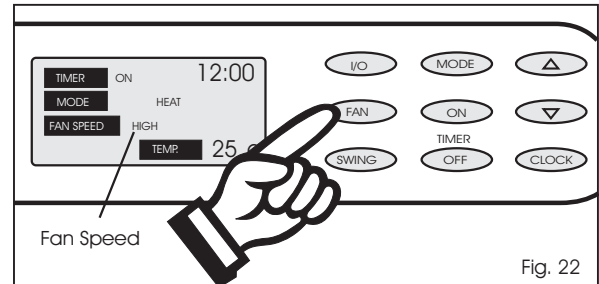

4) Press the **SWING** key to activate the automatic air swing (oscillating) feature, (the "air swing" symbol will appear in the **LCD** window). Fig.23. To deactivate the air swing feature, press the **SWING** key again.

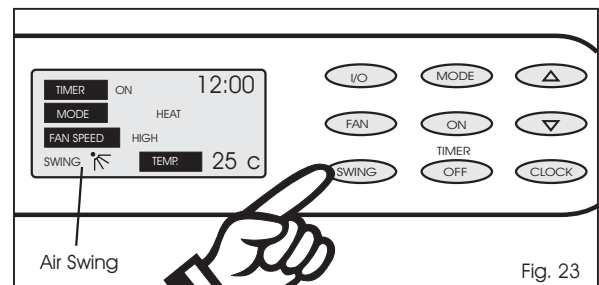

5) To adjust "air flow" direction, (up / down only ) adjust any one of the **Horizontal Louver Blades (excluding the top or bottom louver)** and the remaining louvers will automatically adjust to the same position. Fig.24.

Heating stops automatically when the room temperature reaches the desired setting .The "red" indicator mode light will close. Heating will resume when the room temperature falls below the established temperature setting.

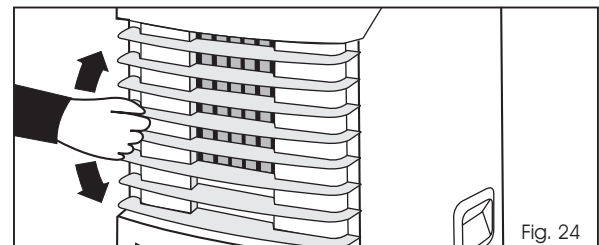

## Fan Operating Instructions

- 1) Press the **I/O** (on/off) key pad to switch on the unit.
- 2) Press the **MODE** key until the word **FAN** is displayed in the **LCD** window. Fig. 25. Each depression of the **MODE** key will advance to a different mode setting (**Cool-Heat-Dry-Fan**). No indicator mode light is visible during operation of the **FAN** mode (this is normal).
- 3) Press the **FAN** key to select the desired **FAN SPEED** setting. Fig.26. Your selection will be displayed in the **LCD** window. Each depression of the fan key will advance to a different speed (**High-Med-Low**).
- 4) Press the **SWING** key to activate the automatic air swing (oscillating) feature (the air swing symbol will appear in the **LCD** window). Fig. 27. To deactivate the swing feature, press the **SWING** key again.
- 5) To adjust "air flow" direction, (up/down only) adjust any one of the **Horizontal Louver Blades** (excluding the top and bottom louver) and the remaining louvers will automatically adjust to the same position. Fig.28.

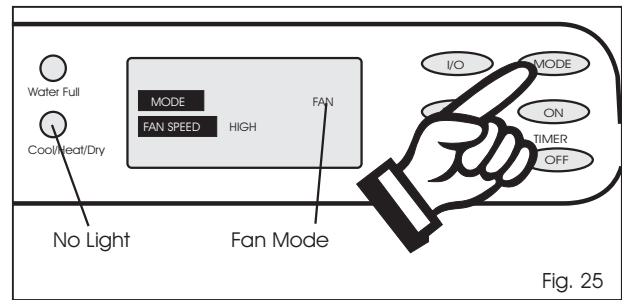

Fig. 25

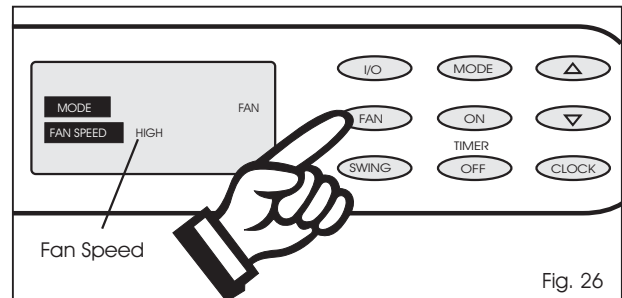

Fig. 26

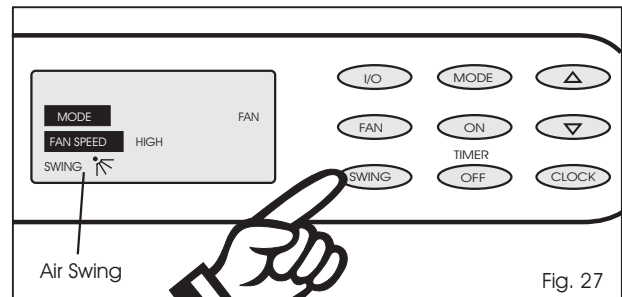

Fig. 27

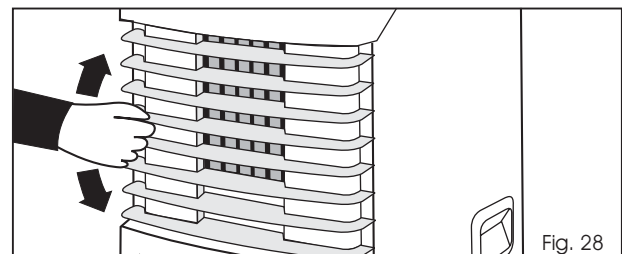
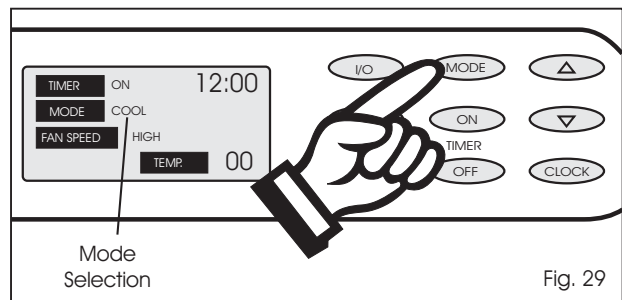

Fig. 28

### Auto-Timer Instructions

**NOTE:** The **TIME OF DAY CLOCK** must be set before the **AUTO-TIMER** feature will operate. The **AUTO-TIMER** feature offers a unique selection of multiple choice, fully automatic on/off(start/stop) programs between 0-23 hrs, 50 min. Under any one mode of your Portable 4 Season Home Comfort unit. The programs are as follows:

- a) **Auto-off:** Pre-select a time that will turn off the unit (automatically) at a specified time (between 0-23 hrs, 50 min.). This function must be performed daily, (if required) as the program is automatically canceled/erased upon completion.
- b) **Auto-On:** Pre-select a time that will turn on the unit (automatically) at a specified time (between 0-23 hrs, 50 min.). This function must be performed daily, (if required) as the program is automatically canceled/erased upon completion.
- c) **Auto-On & Auto-off:** Pre-select a time that will turn on and turn off the unit (automatically) at specified times (between 0-23 hrs, 50 min.). This program contains built-in memory. Unlike programs a)and b) above. This program automatically stores into memory the selected times and will repeat daily,(same specified times) until the program is overridden and/or canceled. Any interruption to the electrical power supply of the unit automatically cancels/erases all auto timed programs. In the event this should happen, you will be required to re-set your program.



### Setting the AUTO-ON TIMER

Before setting the **AUTO-ON** timer, the **TIME OF DAY CLOCK** must be set/operational. You must also select the appropriate **MODE** and settings(**FAN SPEED**,**TEMP**,**SWING** etc.) You will require under the **AUTO TIMED** program.

- 1) Turn the unit"on"(I/O switch).
- 2) Select the appropriate **MODE** under which you want the unit to operate (**Cool-Heat-Dry-Fan**). Fig.29.
- 3) Select the appropriate **FAN SPEED** setting, under which you want the unit to operate.(**High, Med,Low**) (**excluding Dehumidifying, as this mode has"1" fan speed setting only** ).Fig.30.
- 4) If you desire **oscillation**(auto-swing) push the **SWING** key pad (the " air swing" symbol will be displayed in the display window).Fig.31.

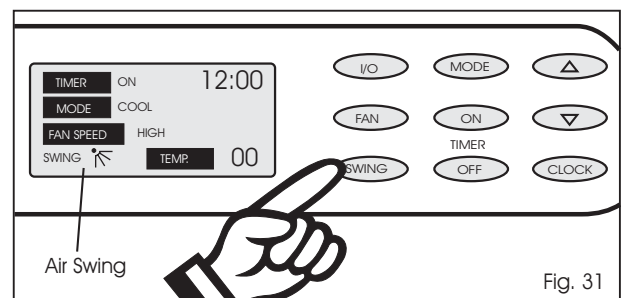
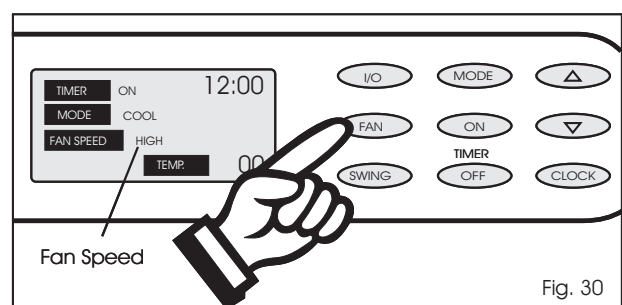

### Setting the AUTO-ON TIMER(cont'd)

5) All of the settings are now registered. **TURN THE UNIT"OFF" USING THE I/O SWITCH.**

6) To set the **AUTO-ON** timer, the unit must be turned to the **"off"** position (non-operational).

7) Press the **TIMER-ON** key pad to initiate the **AUTO-ON** time sequence. Fig. 32. The display window will indicate **TIMER-ON** and the word **ON** will flash for 5 seconds. Press the  $\Delta$  or  $\nabla$  key to select the desired **AUTO-ON** start time. Fig.32a.

$\Delta$  Key pad will decrease the **AUTO-TIMED** Setting in 10 minute increments.

$\nabla$  Keypad will increase the **AUTO-TIMED** Setting in 10 minute increments.

When the desired time is established,(the time will flash in the display window) press the **CLOCK** key pad to register the **AUTO TIMER-ON** program. The word **ON** will stop flashing and remain "on" (**TIMER ON**)indicating the program is set. The time of day clock setting will immediately revert back in the display window.

**IMPORTANT: The desired AUTO-ON time must be registered within a 5 second period (after pressing the TIMER-ON key pad) otherwise the selected time will not register and the system will automatically revert back to the regular "time of day" clock setting. If this occurs, you must repeat step 7 again.**

The unit will start automatically when the specified **AUTO-ON** time is achieved on the time of day clock (the **"TIMER ON"** prompt will disappear from the display window). To cancel or override the **AUTO-TIMED** program,simply turn on the unit before the **AUTO-ON** time is scheduled to operate (the **"TIMER ON"**prompt will disappear from the display window) You can varify the **AUTO-ON** time selection anytime (prior to the program starting )by pressing the **TIMER-ON** key pad. The time you selected will appear(flash)temporarily(replacing the time of day) for approximately 5 seconds.

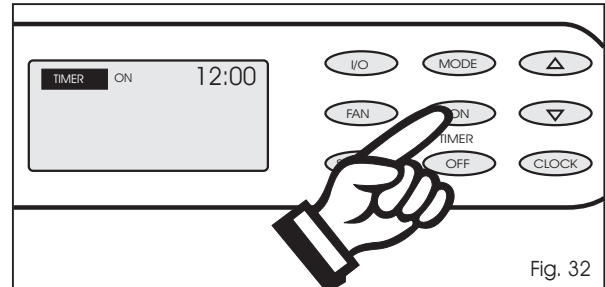

Fig. 32

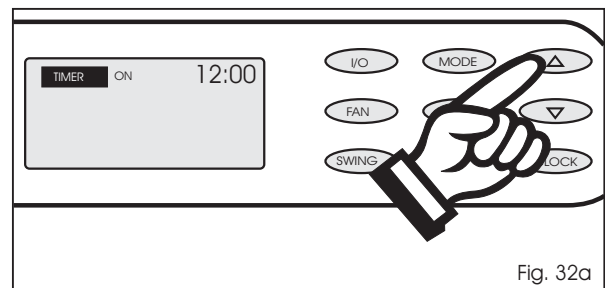

Fig. 32a

## Setting the AUTO-OFF TIMER

Before setting the AUTO-OFF timer, the time of day clock must be set/operational.

- 1) To set the **AUTO-OFF** timer, the unit must be turned on (I/O switch) and operational.
- 2) Press the **TIMER-OFF** key pad to initiate the **AUTO-OFF** time sequence. Fig. 33. The display window will indicate **TIMER-OFF** and the word **OFF** will flash for 5 seconds. Press the  $\Delta$  or  $\nabla$  key pad to select the desired **AUTO-OFF** start. Fig.33a.

$\Delta$  Key pad will decrease the **AUTO-TIMED** Setting in 10 minute increments.

$\nabla$  Keypad will increase the **AUTO-TIMED** Setting in 10 minute increments.

When the desired time is established, (the time will flash in the display window) press the **CLOCK** key pad to register the **AUTO TIMER-OFF** program. The word **OFF** will stop flashing and remain "on" (**TIMER OFF**) indicating the program is set. The time of day clock setting will immediately revert back in the display window. You can verify the AUTO-OFF time selection anytime by pressing the **TIMER-OFF** key pad. The time you selected will appear (flash) temporarily (replacing the time of day) for approximately 5 seconds.

**IMPORTANT: The desired AUTO-OFF time must be registered within a 5 second period (after pressing the TIMER-OFF key pad) otherwise the selected time will not register and the system will automatically revert back to the regular "time of day" clock setting. If this occurs, you must repeat step 2 again.**

The unit will stop automatically when the specified **AUTO-OFF** time is achieved on the time of day clock. To cancel or override the **AUTO-TIMED** program, simply turn off the unit manually, prior to the scheduled **AUTO-OFF** time.

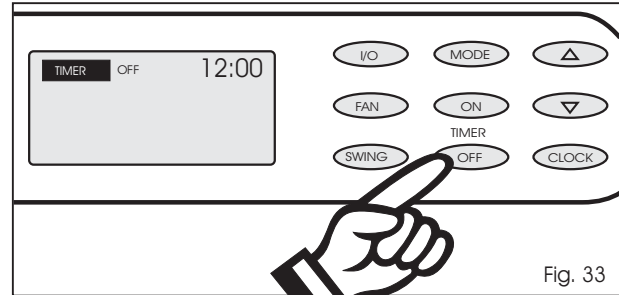

Fig. 33

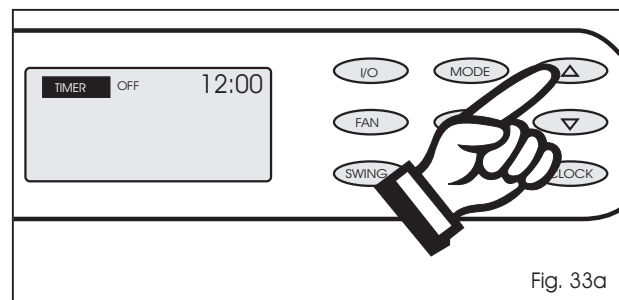

Fig. 33a

### Setting the AUTO-ON & AUTO-OFF TIMER

Before setting the **AUTO-ON & AUTO-OFF Timer**, the **time of day clock** must be set/operational. You must also select the appropriate operating **MODE**. After the appropriate settings have been made, **turn off the unit**.

1) Press the **TIMER-ON** key pad to initiate the **AUTO-ON** time sequence.(Fig.32). The display window will indicate **TIMER-ON** and the word **ON** will flash for 5 seconds. Press the  $\Delta$  or  $\nabla$  key pad to select the desired **AUTO-ON** start time.(Fig. 32a).

$\nabla$  Key pad will decrease the **AUTO-TIMED** setting in 10 minute increments.

$\Delta$  Keypad will increase the **AUTO-TIMED** setting in 10minute increments.

When the desired time is established,(the time will flash in the display window) press the **CLOCK** key pad to register the **AUTO TIMER-ON** program. The word **ON** will stop flashing and remain"on" (**TIMER ON**) indicating the program is set. The time of day clock setting will immediately revert back in the display window

**The unit must remain " OFF" while programming the AUTO-OFF program.**

2) Press the **AUTO-OFF** key pad to initiate the **AUTO-OFF** time sequence. (Fig.33). The display window will indicate **TIMER-OFF** and the word **OFF** will flash for 5 seconds. Press the  $\Delta$  or  $\nabla$ key pad to select the desired **AUTO-OFF** time.(Fig. 32a).

$\nabla$  Key pad will decrease the **AUTO-TIMED** setting in 10 minute increments.

$\Delta$  Key pad will decrease the **AUTO-TIMED** setting in 10 minute increments.

When the desired time is established,(the time will flash in the display window) press the **CLOCK** key pad to register the **AUTO TIMER-OFF** program. The word **OFF** will stop flashing and remain "on" (**TIMER OFF**) indicating the program is set. The time of day clock setting will immediately revert back in the display window.

When the **AUTO-ON & AUTO-OFF** times are set. Within the same program sequence, the display window shows **TIMER ON/OFF** identifying that both **ON** and **OFF** times are now programmed (Repeatable daily until such time the program is canceled and/or changed).

**IMPORTANT: The desired AUTO-ON & AUTO-OFF time must be registered within a 5 second period (after pressing the TIMER-ON/OFF key pads) otherwise the selected time will not register and the system will automatically revert back to the regular "time of day" clock setting**

The unit will start automatically when the specified **AUTO-ON** time is achieved on the time of day clock and will stop automatically when the specified **AUTO-OFF** time is achieved on the time of day clock. To cancel or override the **AUTO-TIMED** program, simply turn the unit on or off prior to the scheduled **AUTO-ON/OFF** time. You can verify the **AUTO-ON/OFF** time selection anytime by pressing each respective **TIMER-ON/TIMER-OFF** key pad and the selected time will temporarily appear replacing the time of day clock for approximately 5 seconds.

## **The Remote Control Unit (RCU) (For remote control units only)**

### **How to Use the Remote Control Unit**

#### **Effective Operation Range**

The RCU should be used within the effective range of 7m from the air conditioner.

#### **Holder for the RCU**

This holder is included together with the RCU.

#### **Installation of the Holder**

Before installation, ensure that the Holder is at a location from where the RCU's signal can reach the air conditioner and operate effectively.

#### **Holder/RCU Operation**

When not in use, the RCU can rest in the Holder. The Holder will help prevent your RCU from being misplaced.

#### **Precautions for Using the RCU**

- Do not operate the RCU near contains, door or obstacles which may block the RCU's transmission of signals, otherwise the air conditioner will not work as controlled.
- Keep the RCU away from water or other fluid, direct sunlight or heat.
- Avoid direct sunlight to the infra-red receiver in the air conditioner, sunlight will affect the effectiveness of the air conditioner.
- Other electrical appliances may affect the signals from the RCU. Consult your nearest distributor should you encounter any problem.

#### **Battery Installation**

Type AM4 alkaline batteries should be used for the RCU.

1. Slide out the RCU lower cover, take out old batteries and replace by new ones.
2. Press the "reset" button.
3. Before closing the battery cover, please note that the time displayed on the unit's screen is "0:00" and the colon ":" blinks.
4. When installing new batteries, you have to reset the time on the RCU.

#### **Caution**

- Do not mix old batteries with new ones or use different bands or type of batteries otherwise the RCU will not work.
- When the RCU is not in use for periods of several weeks, take out of the batteries, otherwise any leakage from the batteries will ruin the RCU.
- Life of the batteries is about six months under normal use.
- Replace the batteries when you do not hear the sound of the receiver when operating or there is no display on the LCD screen.

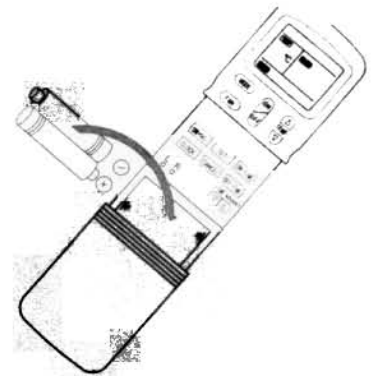
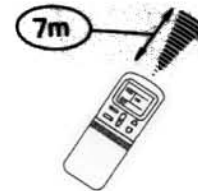

# OPERATION BUTTONS ON THE RCU

**MODE**  
When you want to choose an operation, press it once:  
auto → cooling → dehumidify  
↑ fan ← heating ←  
  
Note: Heating feature is only available in Heating/Cooling Models.

**FAN**  
Press once to choose wind speed:  
auto → low → med  
↑ high ←

**ON/OFF**  
Press once to start the air conditioner and stop it when pressing once more.

**TEMP ADJ.**  
Press once for adjusting temp.  
△ TEMP. increase  
▽ TEMP. decrease

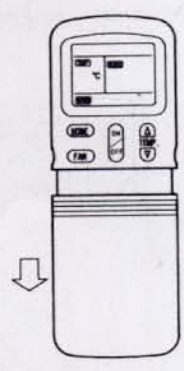
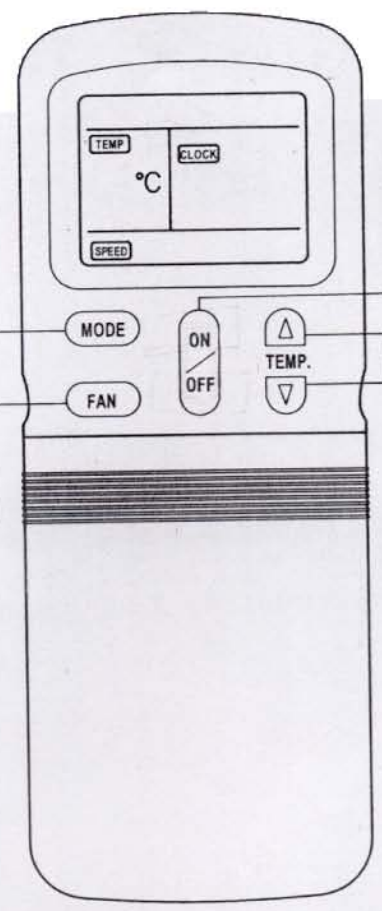

Slide out this lower

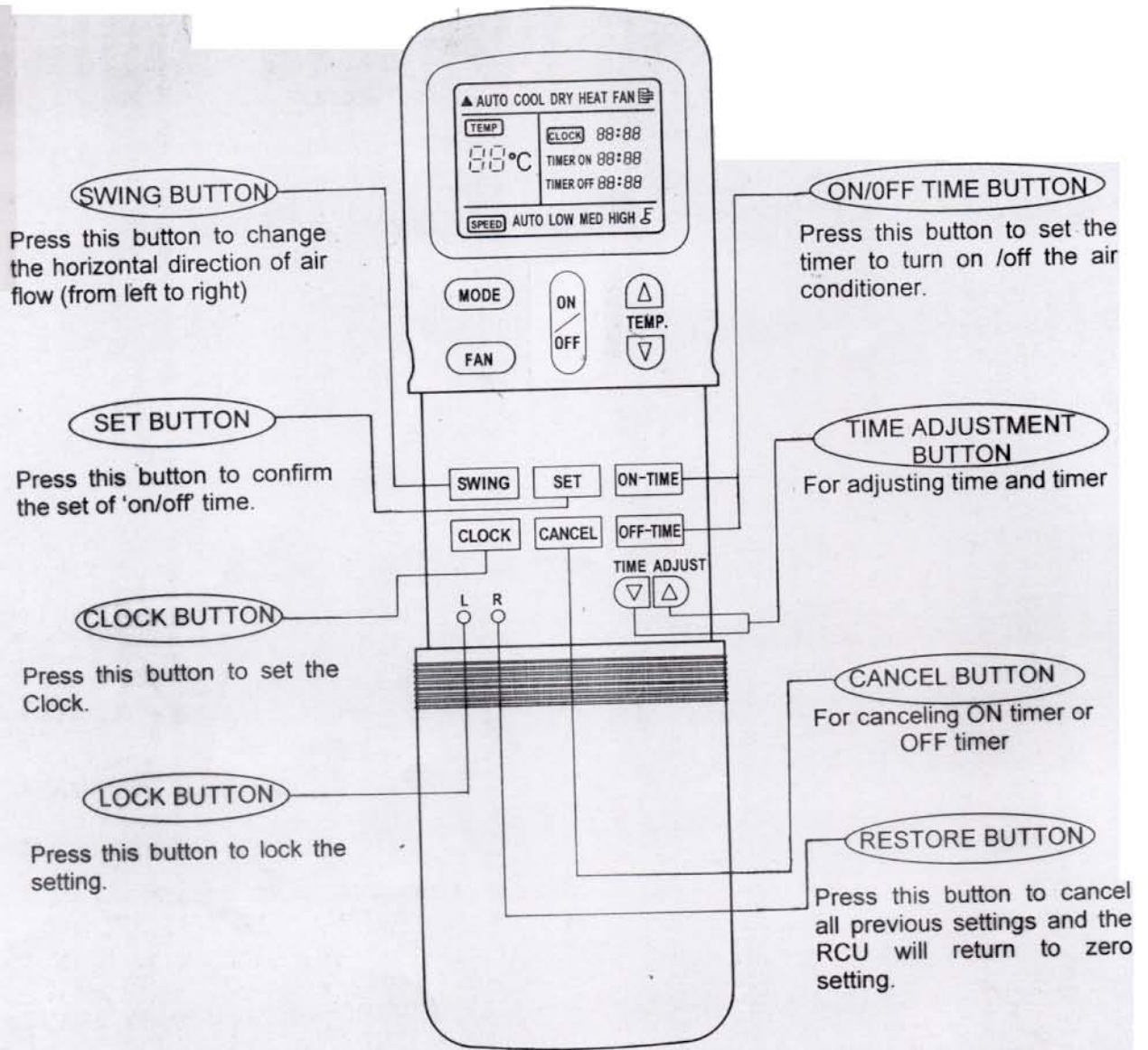

## NAMES AND FUNCTIONS FOR THE OPERATING PANEL WINDOW OF THE RCU.

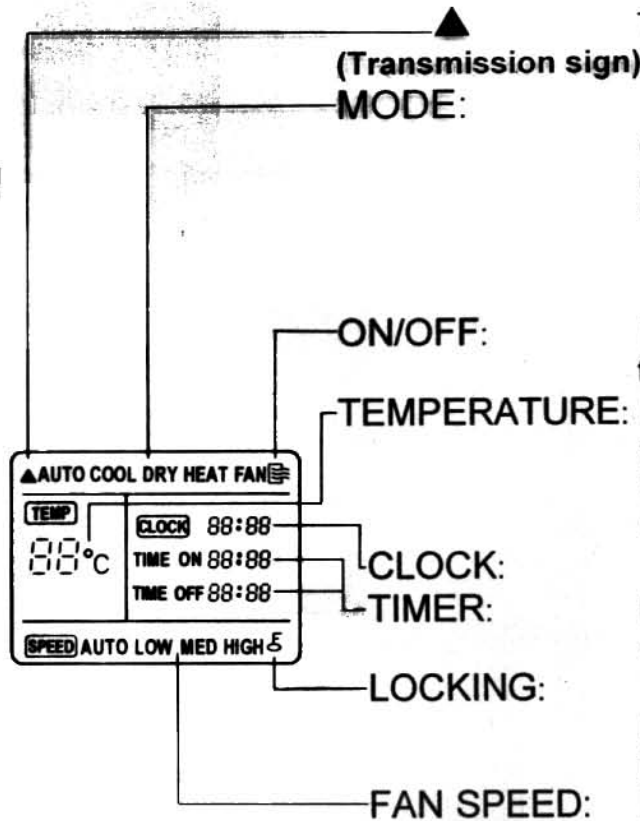

This sign flashes once when the signal from the RCU is transmitted to the air conditioner.

Press the "MODE" button to display the different operational mode. You can select different operations including "AUTO", "COOL", "DRY", "HEAT", "FAN".

Press once to switch ON or OFF. Press again to cancel display.

Press this button to display the selected temperature (the operating range is 17°C-30°C). The selected temperature will not display if operation mode is set to "FAN".

Displays (0-24 hours) of the day.

Press "ON-TIME" or "OFF-TIME" button to display display the time selected. (0-24 hours):

Press once the "LOCK" button to display the locking sign. The sign disappears when press it once more.

Press the "FAN" button to display the different fan speeds. You can select different fan speeds such as "AUTO", "LOW", "MED", "HIGH". When the operational mode is in "AUTO" or "DRY", the fan speed is set to "AUTO".

**NOTE:** All the signs appear in the operating panel window of the above figure are only for reference. During operation, only the signs for the corresponding operational mode will appear.

# OPERATING INSTRUCTION FOR THE RCU

## CLOCK SETTING

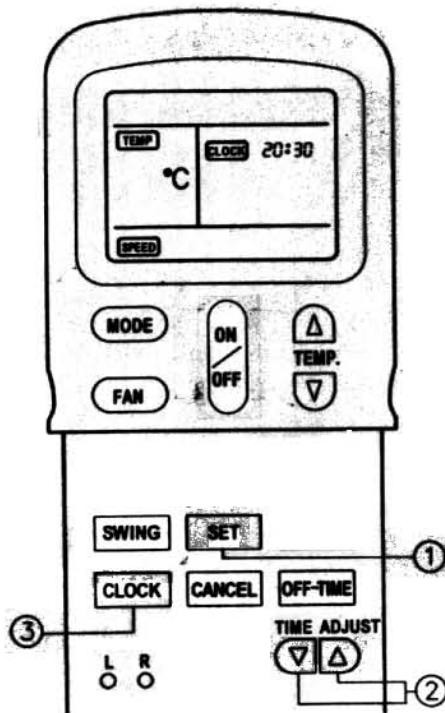

Before operation, please refer to the following step to set the time. The time should be set same as that of the main unit.

When new batteries are installed, the time displayed on the screen appears "0:00" and the colon blinks continuously.

### Timer Preset

1. Press  $\nabla$  or  $\Delta$  to adjust the time.
2. Press **SET** button to start the time and the colon stops blinking.

### Timer Reset

3. Keep pressing the **CLOCK** button for at least three seconds, the colon sign in the time displayed begins to blink.  
Repeat step 1 and 2.

**NOTE:** Accuracy of time is less than 10 seconds per day.

## AUTOMATIC OPERATION

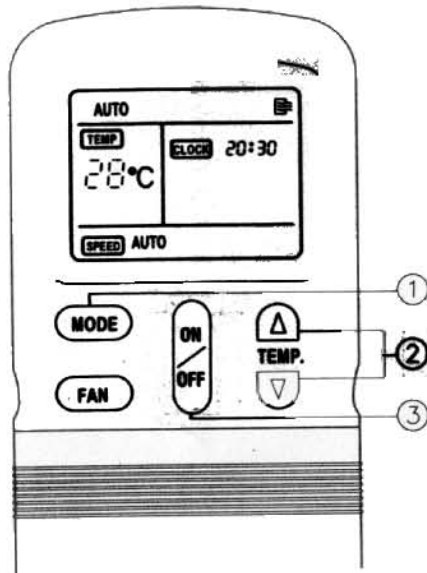



1. After installation of the air conditioner, check and make sure power is on and the Drain Tank is correctly positioned.
2. Press **MODE** button, then select "AUTO"
3. Press the **TEMP** button  $\nabla$  or  $\Delta$  to select your desired room temperature. Usually it should be set to 21°C~28°C.
4. Press **ON/OFF** button. The air conditioner start to operate automatically and the fan speed controls appears in "AUTO" mode.

Stop: Press the **ON/OFF** button once again to cancel the operations.

**NOTE:** In "AUTO" mode, the air conditioner can select automatically the operation mode including "cooling", "ventilating" or "heating (for heating/cooling models only)".

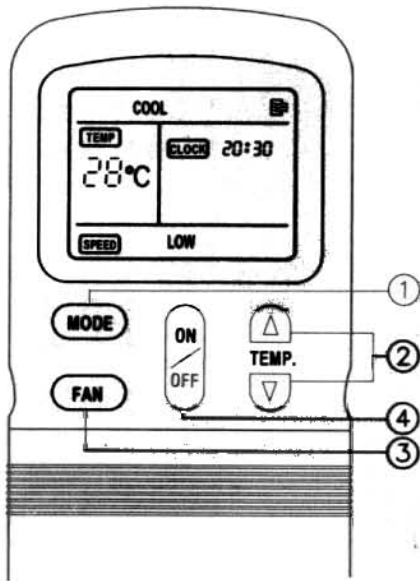
## COOLING/HEATING/FAN OPERATION





1. Check and make sure power is on and the Drain Tank is correctly positioned.
2. Press **MODE** button to select "COOL", "HEAT", "FAN" operation mode.
3. Press the **TEMP** button  or  to select your desired room temperature. Usually it should be set to 21°C or 28°C.
4. Press the **FAN** button to select your desired wind speed, including "AUTO", "LOW", "MED", "HIGH".
5. Press the **ON/OFF** button and the air conditioner operates as your select.

**Stop:** Press the **ON/OFF** button once again to cancel the operations.

**NOTE:** In "FAN" operation mode, the temperature can not be controlled, and you need not to set the room temperature.

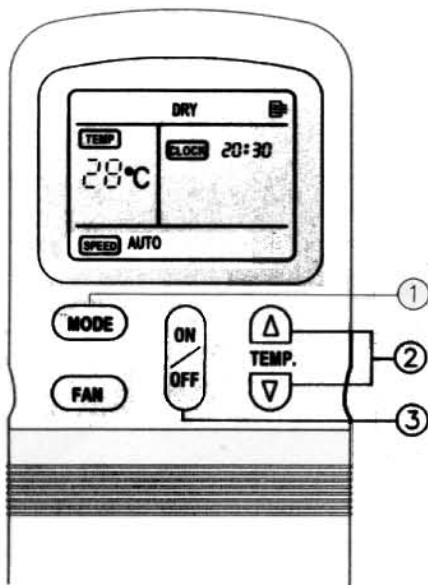
## DEHUMIDIFYING OPERATION



1. After installation of the air conditioner, check and make sure power is on and the Drain Tank is correctly positioned.
2. Press **MODE** button, then select "DRY" as your operation mode.
3. Press the **TEMP** button  or  to select your desired room temperature. Usually it should be set to 21°C~28°C.
4. Press **ON/OFF** button. The air conditioner start to dehumidifying. The screen on the RCU indicates the fan speed as "AUTO".

**Stop:** Press the **ON/OFF** button once again to cancel the operations.

**NOTE:** The dehumidifying mode operates and stops automatically when the preset temperature and the room temperature are different or same. This makes humidity of the room lower.

# TIMER SETTING

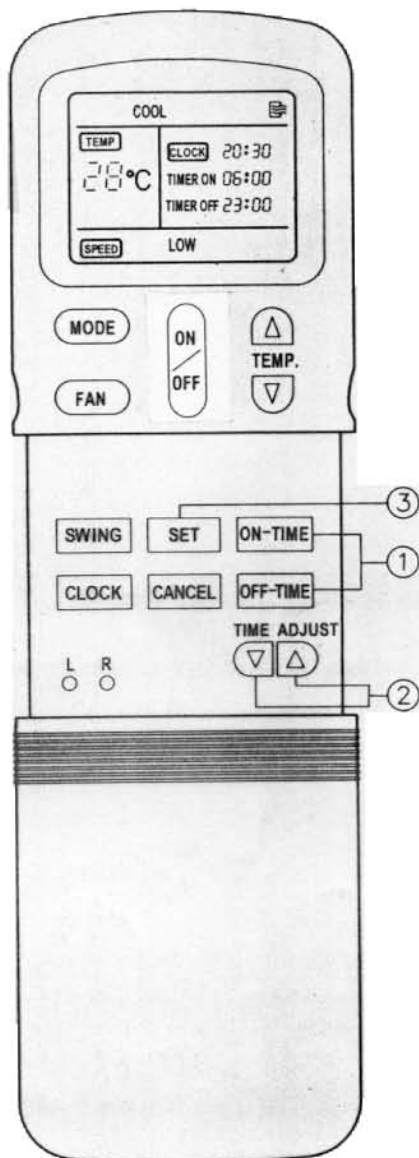

1. Before setting the timer, it is advisable to complete clock setting.

2. Press **ON-TIME** or **OFF-TIME** button, the time displayed in either these two modes will have the colon blinking.

3. Press the **TIME ADJUST** button  or  to adjust the correct time.

4. Press the **SET** button, the screen of main unit display the time you have set, and the air conditioner switch on/off automatically according to your time setting.

**CANCEL:** Press the **CANCEL** button to cancel the timer reservation.

**RESET:** Press **CANCEL** and then follow instruction 2 and 3.

## **CAUTION:**

1. Setting for "TIMER ON" and "TIMER OFF" can be achieved independently or simultaneously.
2. When "TIMER ON" and "TIMER OFF" are set to be achieved simultaneously, the air conditioner operates to the nearest time for either "TIMER ON" or "TIMER OFF".
3. If both "TIMER ON" and "TIMER OFF" are set in the same reserved time, the controller stop functioning.
4. When time you set reached, the air conditioner switch on/off automatically, and the "TIMER ON" or "TIMER OFF" displayed on RCU screen disappears accordingly.

## Care and Maintenance



### CAUTION



Before cleaning or servicing this unit, it is recommended that the unit be disconnected from any electrical supply outlet

- 1) **Do Not** use gasoline, benzene, thinner or any other chemicals to clean this unit, as these substances may cause damage to the finish and deformation of plastic parts.
- 2) **Never** attempt to clean the unit by pouring water directly over any of the surface areas, as this will cause deterioration of electrical components and wiring insulation.

#### Removal and Cleaning of the Air Filter

If the air filter becomes clogged with dust/dirt, air flow is restricted and reduces efficiency. The air filter should be cleaned every two (2) weeks. More frequent cleaning may be necessary depending upon indoor air quality.

- 1) To remove the air filter: Grasp the air filter tab.
- 2) Pull the filter "out" then "up". Fig.34.
- 3) Dust/Dirt clogged in the filter can be removed by vacuum cleaning the soiled areas.
- 4) The filter can also be washed in lukewarm soapy water while rubbing it lightly with a brush. A mild detergent (dishwashing soap) is recommended.
- 5) Rinse the filter well using clean water. Allow time to dry before reinstalling into the unit.
- 6) Relace the air filter.
- 7) Replacement air filters are available through the Customer Service Parts Department.

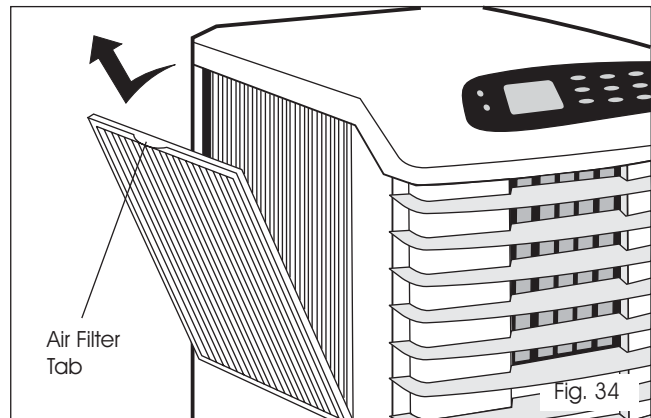

### CAUTION



Never operate the unit without the air filter in place as this may result in damage to the unit.