

This Owner's Manual is provided and hosted by [Appliance Factory Parts](#).



PANASONIC CW-1206FU Owner's Manual

[Shop genuine replacement parts for PANASONIC
CW-1206FU](#)



[Find Your PANASONIC Air Conditioner Parts - Select From 287 Models](#)

----- Manual continues below -----

Operating Instructions

Room Air Conditioners

Before using your air conditioner, please read this operating instructions carefully and keep it for future reference.

MODELS:

CW-1005FU, CW-1006FU,

CW-1205FU, CW-1206FU.

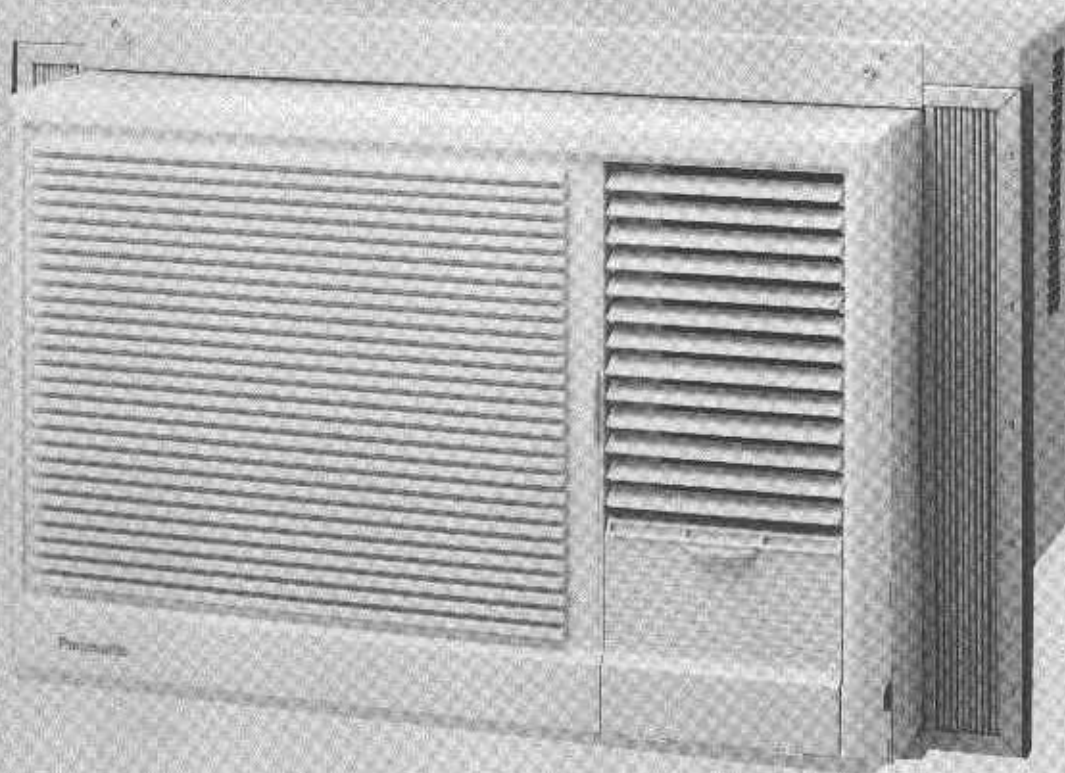

ENGLISH P.2 ~ P.15

ESPAÑOL P.16 ~ P.29

Panasonic[®]

F56906



IMPORTANT SAFEGUARDS

The following are important instructions to be observed to prevent malfunctions or serious problems with your air conditioner.

1. Install the air conditioner by following the installation instructions enclosed with the product.
2. Do not modify any parts of this product.
3. Do not operate the unit without an air filter.
4. Do not put sticks, rods, etc., into any parts of the unit.
5. Do not obstruct the air intake of the evaporator with a curtain or window blind, as it may result in insufficient cooling power and abnormal operation.
6. Operate your air conditioner from a stable 115 Volt AC power supply.
7. Plug into a separate 15 amp grounded outlet only.
8. Use of Extension Cords.
Extension cords of any kind should not be used. If there is no alternative, the cord should be a UL listed 3-wire grounding type, rated 125 volt with a minimum current carrying rating of 15 amps-number 14 or heavier wire.
9. Use a 15 amp time delay fuse or a circuit breaker.
10. Do not install the unit close to any places where inflammable gas, fumes or soot may be generated.
11. Do not unplug the unit while it is operating. Turn the Main Switch to "OFF" and then unplug.

SAVE THESE INSTRUCTIONS

DETALLES DE SEGURIDAD IMPORTANTES

Las siguientes instrucciones son importantes de tener en cuenta para evitar malfuncionamientos o problemas serios con su acondicionador de aire.

1. Instale el acondicionador de aire siguiendo las instrucciones de instalación que vienen con este producto.
2. No modifique ninguna de las piezas de este producto.
3. No haga funcionar este aparato sin el filtro de aire.
4. No introduzca palillos, lápices, etc. dentro de este aparato.
5. No tape la toma de aire del evaporador con una cortina o similar, pues puede resultar en insuficiente fuerza de enfriamiento y funcionamiento anormal.
6. Haga funcionar su acondicionador de aire desde una fuente de alimentación de CA de 115 voltios.
7. Enchúfelo sólo en un tomacorriente separado de 15 amp con conexión a tierra.
8. Uso de cables de extensión.
No se deben usar cables de extensión de ningún tipo. Si no existiera otra posibilidad, el cable deberá ser del tipo ul de 3 alambres con conexión a tierra, de 125 voltios y con un amperaje mínimo de 15 amp, de alambre número 14 o mayor.
9. Use un fusible de retardo de 15 amp o un ruptor de circuito.
10. No instale el aparato cerca de un lugar donde haya gases inflamables, emanaciones de humo u hollín.
11. No desenchufe el aparato mientras está funcionando. Gire la perilla de control principal a la posición "OFF" y luego desenchúfelo.

GUARDE ESTAS INSTRUCCIONES

CONTENTS

• Product Component Identification	2
CW-1005FU	
• Air Conditioner Operation	3
CW-1005FU	
• Product Component Identification	4
CW-1205FU	
• Air Conditioner Operation	5
CW-1205FU	
• Product Component Identification	6
CW-1006FU, CW-1206FU	
• Air Conditioner Operation	7 ~ 8
CW-1006FU, CW-1206FU	
• Helpful Reminders	9
• Care and Maintenance	10 ~ 11
• Before Calling for Service	12
• Product Specifications	13
• Customer's Record	14

CONTENIDO

• Identificación de los componentes	16
CW-1005FU	
• Funcionamiento del acondicionador de aire	17
CW-1005FU	
• Identificación de los componentes	18
CW-1205FU	
• Funcionamiento del acondicionador de aire	19
CW-1205FU	
• Identificación de los componentes	20
CW-1006FU, CW-1206FU	
• Funcionamiento del acondicionador de aire	21 ~ 22
CW-1006FU, CW-1206FU	
• Consejos útiles	23
• Cuidados y mantenimiento	24 ~ 25
• Antes de llamar al técnico	26
• Especificaciones del producto	27
• Registro del Cliente	28

PRODUCT COMPONENT IDENTIFICATION

CW-1005FU

Airflow Direction Vane

(Vertical Airflow Direction Adjustment Up-and-Down)

The vertical airflow direction vane is controlled by positioning the vane to discharge the air upwards, downward or straight out.

(Horizontal Airflow Direction Adjustment Side-to-Side)

The horizontal airflow direction vane is controlled by positioning the tab to discharge the air to the right, left or straight out.

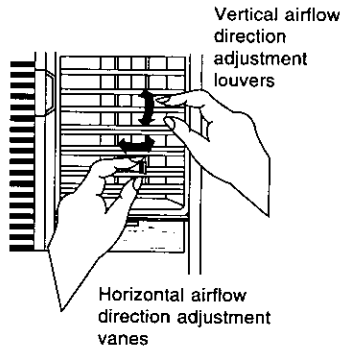

ACCESSORIES

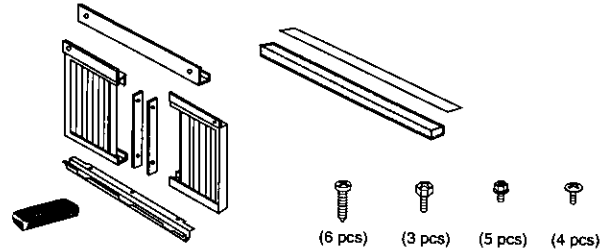

Air intake grille

Air filter

Air outlet grille

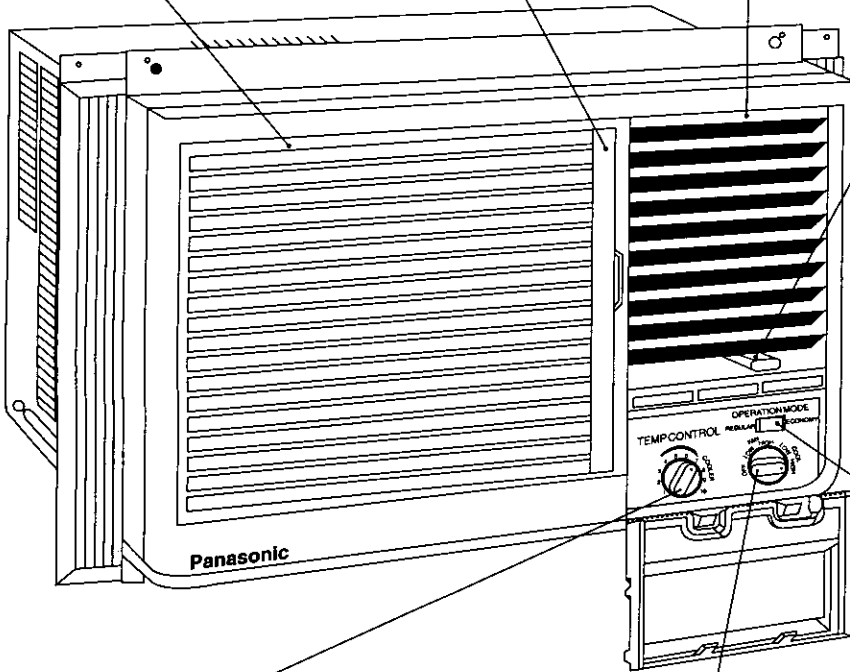

VENT DOOR

In the open position this door will allow smoke and odors laden air to be vented outdoors.



Power supply cord

Temp Control Knob

TEMP CONTROL

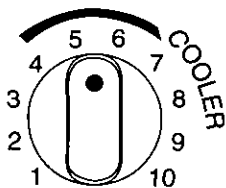

Main Control Knob

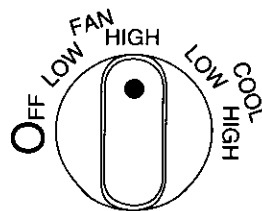

Operation Mode Switch

OPERATION MODE

REGULAR

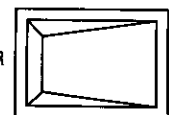

ECONOMY

AIR CONDITIONER OPERATION

CW-1005FU

1. Power Supply

Set the main control knob to the OFF position; confirm that the power supply cord is connected to a proper AC outlet.
<115V, 60Hz>

2. Main Control Knob

Set MAIN CONTROL KNOB to desired position.

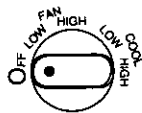

OFF
Stops all operations.



LOW FAN
Fan only operation without cooling at low fan speed.

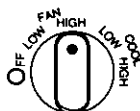

HIGH FAN
Fan only operation without cooling at high fan speed. (Fan only operation recirculates filtered room air).



LOW COOL
Cooling operation at low fan speed.



HIGH COOL
Cooling operation at high fan speed.

Note: For fan only operation, operation Mode Switch must be in regular position.

3. Temp Control Knob

TEMP CONTROL



For a room that is too warm, set the control knob to clockwise direction.

If the room is too cool, set the control knob to anti-clockwise.

Note: Usually 6 – 7 is recommended setting position.

4. Operation Mode Switch

OPERATION MODE

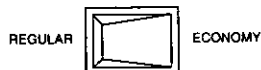

REGULAR POSITION:

The temp. control automatically controls cooling, but the fan runs continuously whenever the air conditioner is in operation.

ECONOMY POSITION:

The temp. control automatically controls cooling, but when the room temperature reaches the temp. control preset point, both the fan and compressor turn off. When the temp. control requires the cooling operation to start again, both the fan and compressor turn back on together.

Note: If only the fan operation is desired, set the operation mode switch to "REGULAR".
The fan will not run with the switch setting combination at "FAN" of main control knob and "ECONOMY" of operation mode switch.

*Caution:

If the main control knob is turned off or changed to a fan setting from a cooling operation setting, WAIT at least 3 minutes before resetting to a cooling operation.

PRODUCT COMPONENT IDENTIFICATION

CW-1205FU

Vertical Airflow Direction Vane (Airflow direction adjustment Up-and-Down)

The vertical airflow direction vane is controlled by positioning the vane to discharge the air upwards, downward or straight out.

Vertical airflow direction adjustment louvers

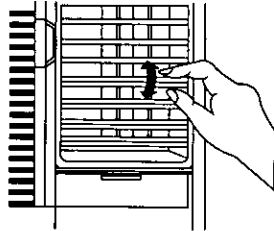

ACCESSORIES

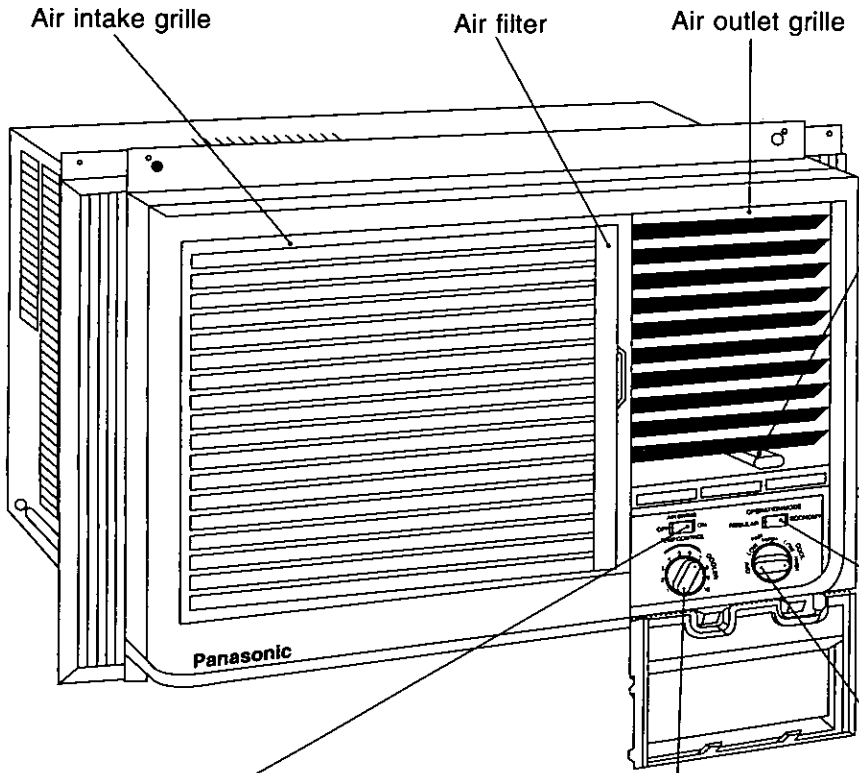
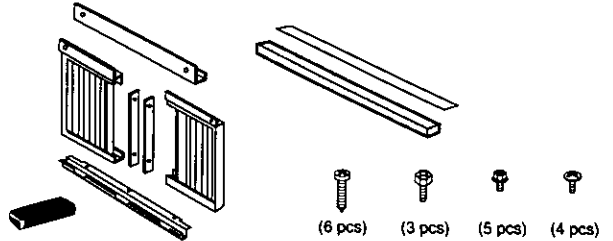

VENT DOOR

In the open position this door will allow smoke and odors laden air to be vented outdoors.

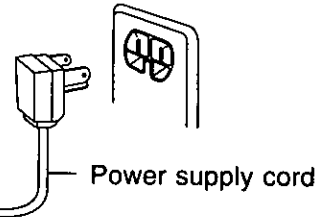

Power supply cord

Operation Mode Switch

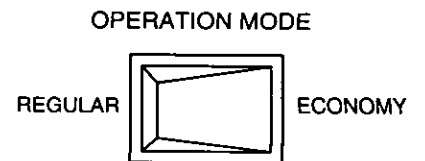

Air Swing Switch

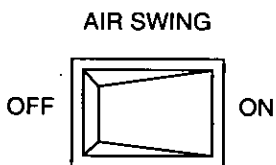

Temp Control Knob

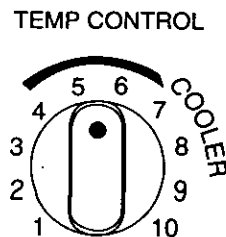

Main Control Knob

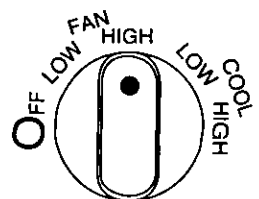

AIR CONDITIONER OPERATION

CW-1205FU

1. Power Supply

Set the main control knob to the OFF position; confirm that the power supply cord is connected to a proper AC outlet.
<115V, 60Hz>

2. Main Control Knob

Set MAIN CONTROL KNOB to desired position.

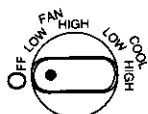

OFF
Stops all operations.

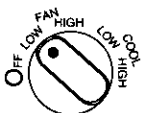

LOW FAN
Fan only operation without cooling at low fan speed.

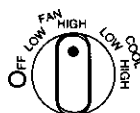

HIGH FAN

Fan only operation without cooling at high fan speed. (fan only operation recirculates filtered room air).



LOW COOL

Cooling operation at low fan speed.

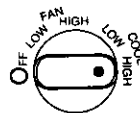

HIGH COOL

Cooling operation at high fan speed.

Note: For fan only operation, operation Mode Switch must be in regular position.

3. Temp Control Knob

TEMP CONTROL

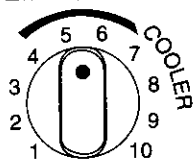

For a room that is too warm, set the control knob to clockwise direction.

If the room is too cool, set the control knob to anti-clockwise.

Note: Usually 6 - 7 is recommended setting position.

4. Operation Mode Switch

OPERATION MODE



REGULAR POSITION:

The temp. control automatically controls cooling, but the fan runs continuously whenever the air conditioner is in operation.

ECONOMY POSITION:

The temp. control automatically controls cooling, but when the room temperature reaches the temp. control preset point, both the fan and compressor turn off. When the temp. control requires the cooling operation to start again, both the fan and compressor turn back on together.

Note: If only the fan operation is desired, set the operation mode switch to "REGULAR". The fan will not run with the switch setting combination at "FAN" of main control knob and "ECONOMY" of operation mode switch.

5. Air Swing Switch

AIR SWING

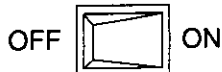

For continuous side-to-side air circulation, turn the Air Swing Switch to "ON".

To obtain airflow in a fixed direction, turn the switch to "ON"; then turn it to "OFF" when the desired airflow direction is obtained.

*Caution:

If the main control knob is turned off or changed to a fan setting from a cooling operation setting, WAIT at least 3 minutes before resetting to a cooling operation.

PRODUCT COMPONENT IDENTIFICATION

CW-1006FU, CW-1206FU

Vertical Airflow Direction Vane (Airflow direction adjustment Up-and-Down)

The vertical airflow direction vane is controlled by positioning the vane to discharge the air upwards, downward or straight out.

Vertical airflow direction adjustment louvers

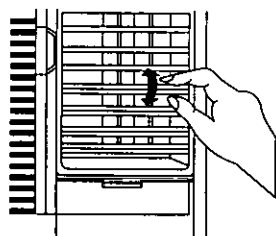

ACCESSORIES

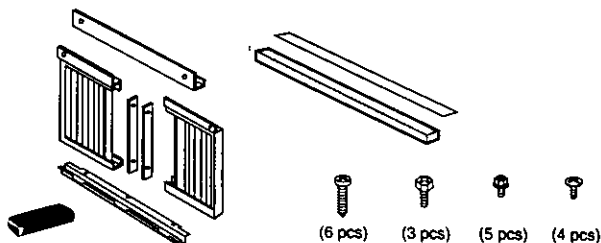

Air intake grille Air filter Air outlet grille

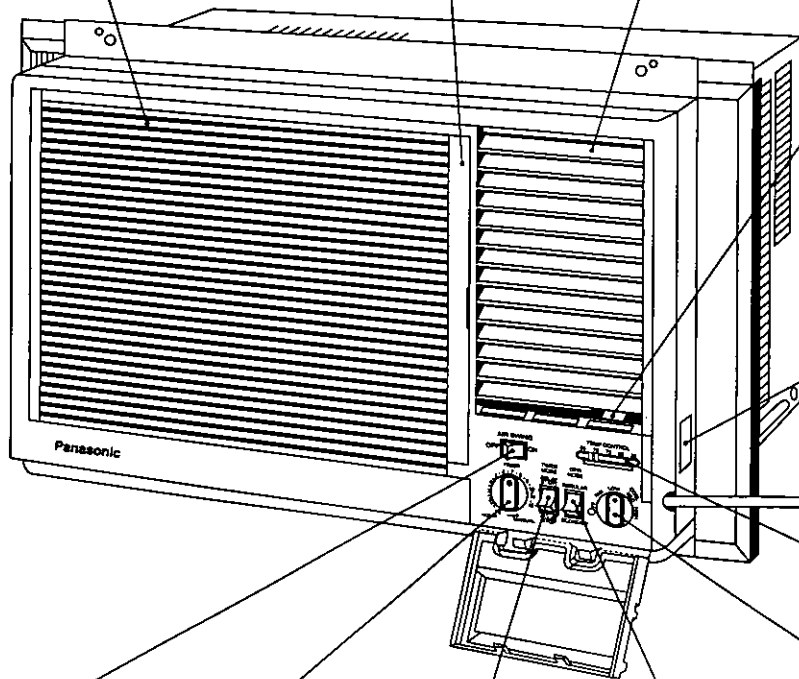

VENT DOOR

In the open position this door will allow smoke and odors laden air to be vented outdoors.



Model/Serial Number Label



Power supply cord

Air Swing Switch

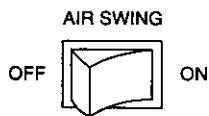

Timer Control Knob

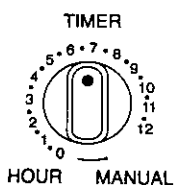

Timer Mode Switch



Opr Mode Switch

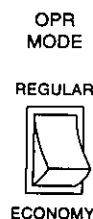

Main Control Knob

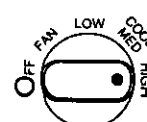

Temp Control Knob

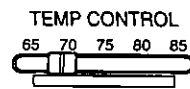

AIR CONDITIONER OPERATION

CW-1006FU, CW-1206FU

1. Power Supply

Set the main control knob to the OFF position; confirm that the power supply cord is connected to a proper AC outlet.
<115V, 60Hz>

2. Main Control Knob

Set MAIN CONTROL KNOB to desired position.

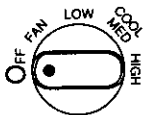

OFF
Stops all operations.

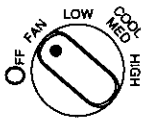

FAN
Fan only operation for normal room air circulation.

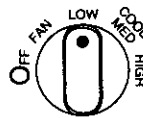

LOW COOL
Cooling operation at low fan speed.

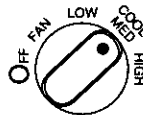

MED COOL
Cooling operation at medium fan speed.

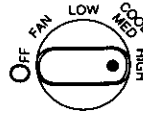

HIGH COOL
Cooling operation at high fan speed.

Note: For fan only operation, operation Mode Switch must be in "REGULAR" position.

3. Temp Control Knob

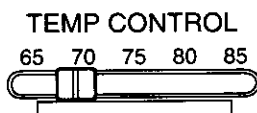

For a room that is too warm, set the control knob to a low number.

If the room is too cool, set the control knob to a higher number.

Note: Usually 75 is recommended setting position.

4. Operation Mode Switch



REGULAR POSITION:

The temp. control automatically controls cooling, but the fan runs continuously whenever the air conditioner is in operation.

ECONOMY POSITION:

The temp. control automatically controls cooling, but when the room temperature reaches the temp. control preset point, both the fan and compressor turn off. When the temp. control requires the cooling operation to start again, both the fan and compressor turn back on together.

Note: If only the fan operation is desired, set the operation mode switch to "REGULAR". The fan will not run with the switch setting combination at "FAN" of main control knob and "ECONOMY" of operation mode switch.

AIR CONDITIONER OPERATION

CW-1006FU, CW-1206FU

5. Air Swing Switch



For continuous side-to-side air circulation, turn the Air Swing Switch to "ON".

To obtain airflow in a fixed direction, turn the switch to "ON"; then turn it to "OFF" when the desired airflow direction is obtained.

6. Timer Control Knob

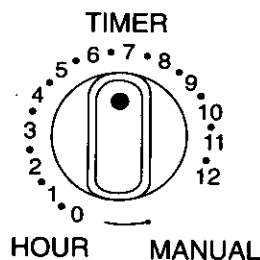

When you turn the Timer Control knob to the MANUAL setting, the air conditioner starts immediately and operates continuously if the Main Control knob is at any setting other than OFF.

When used with Timer Mode switch, the Timer Control knob will turn air conditioner on or off at preset times.

7. Timer Mode Switch



DELAY START

TO DELAY THE START OF THE AIR CONDITIONER any where from 1 to 12 hours:

1. Set the Timer Control knob for the number of hours you want to delay the start of the air conditioning operation.
2. Set the Timer Mode switch at DELAY START.
3. Turn the Main Control knob to the desired setting.

DELAY STOP

TO STOP THE AIR CONDITIONING OPERATION from 1 to 12 hours later:

1. Set the Timer Control knob for the number of hours you want the air conditioner to operate before shutting off automatically.
2. Set the Timer Mode switch at DELAY STOP.
3. Turn the Main Control knob to the desired setting.

Note: If the unit is turned OFF and immediately on again, an automatic protection device will prevent restart of the compressor for approximately 3 minutes.

THIS IS NORMAL. LEAVE THE SWITCH ON AND OPERATION WILL RESUME AUTOMATICALLY WHEN THE PROTECTION DELAY IS COMPLETED.

HELPFUL REMINDERS

- Do not block the cool air outlets. (Otherwise, cooling efficiency may decrease result.)

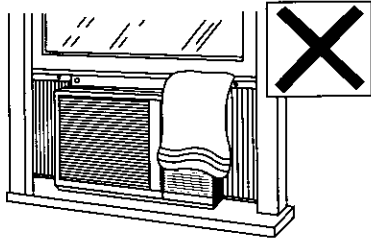

- Do not operate the unit without inserting the air filter. (Dust may clog the evaporator or unit failure may result.)

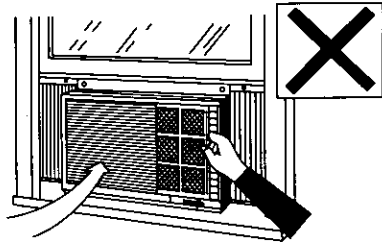

- Be sure to use the specified replacement parts. (Otherwise, fire or damage may result.)

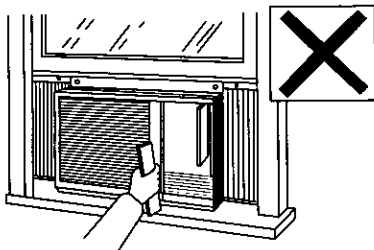

- Do not attempt to repair the unit in case of trouble. (Be sure to ask a service person for repairs.)

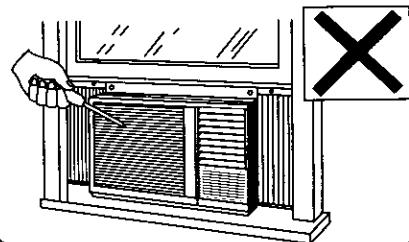

- To unplug the power cord, be sure to hold the plug instead of the cord.

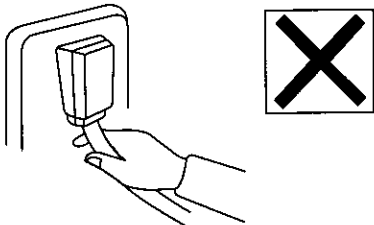

- Be sure to turn off the power or unplug the power cord in case of power failure. (After the power is restarted, wait for at least 3 minutes before restarting the unit.)

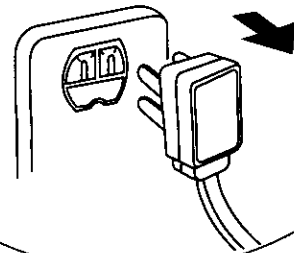

CARE AND MAINTENANCE

Precautions for cleaning

Do not use strong cleaning agents.

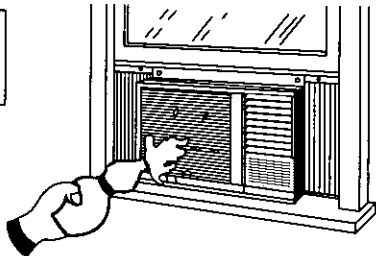

Do not splash water or detergent into the unit's body openings.

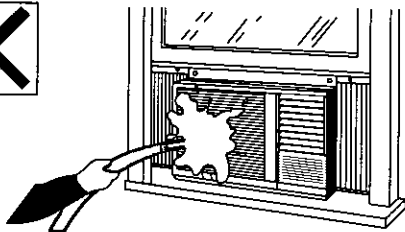

Do not remove the control board (You may risk electric shock.)

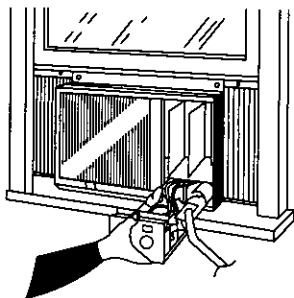

Do not touch or pull the power cord with wet hand(s). (You may risk serious electric shock.)

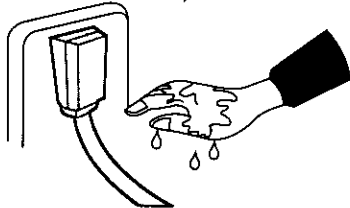

Air conditioner body

1. Unplug the power cord.

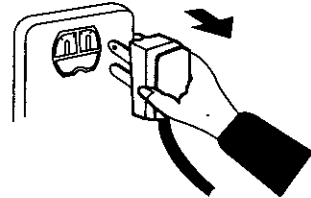

2. Wipe the front grille with a cloth dampened in soap-and-water solution or lukewarm-water.

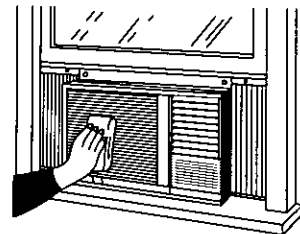

3. Rid the rear air inlets of dust by using a paint brush, or the like.

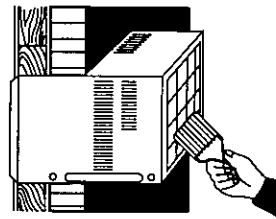

4. If the unit is badly soiled, contact your nearest Panasonic servicenter.



CAUTION: Wipe off dirt with a soft, dry cloth (use a vacuum cleaner to remove dust from the air inlet).

Use a cloth and water less than 104°F to remove stubborn dirt (the cloth should be well-wrung).

Do not use the following cleansers as they may cause the paint to peel and lead to malfunctions: Benzene, thinner, scouring powder, chemical soaked cloths, etc.



Air filter every 2 weeks

1. To remove the air filter, pull its removal tab to the right.

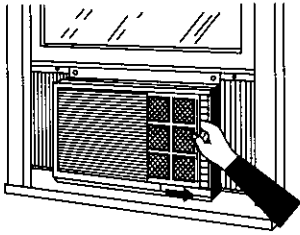

2. Vacuum-clean its front (or wipe it clean with a cloth).

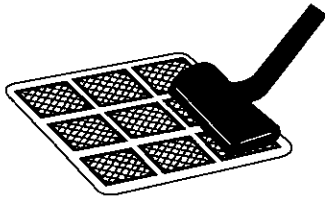

3. Wash rear side with water.

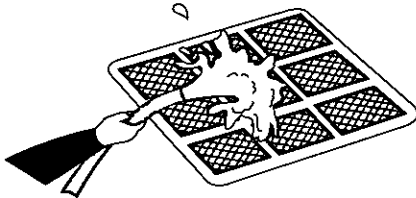

4. If the air filter is badly soiled, wash it with mild household detergent, let it dry and place it back in position.

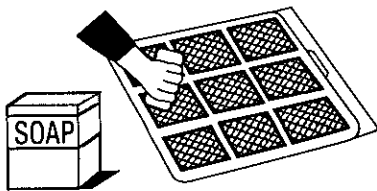

Front grille

1. Remove the air filter.

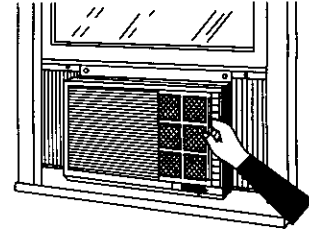

2. Remove the screws, as shown.

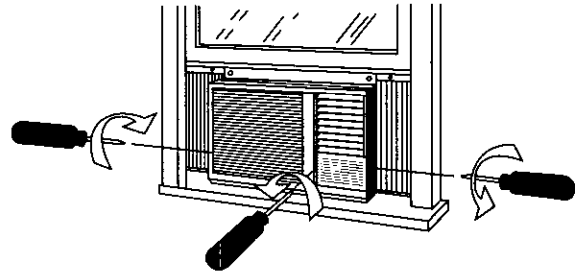

3. Pull the front grille towards yourself from the bottom first, lift up and remove it.

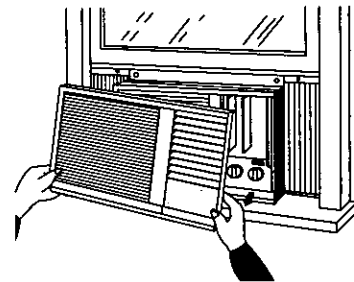

4. Wipe it clean with a damp cloth.

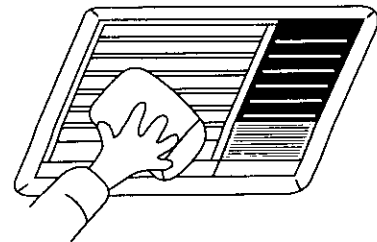

BEFORE CALLING FOR SERVICE

Problem Symptom

Possible cause and remedy

Unit does not operate

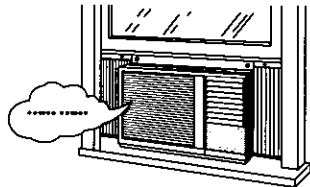

- Power cord is not plugged.
- Fuse is blown or circuit breaker has tripped.

Unit does not cool properly

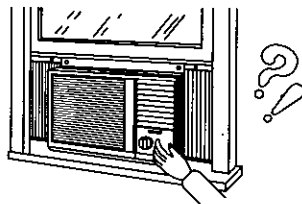

- Temp Control is set at lower number levels.
- Air filter is soiled.
- Room is warm. Wait for the room temperature to drop.
- Ventilation lever is set OPEN.
- The air circulation is impeded by drapes, furniture, etc., or by an improper louver setting.

Operating noise

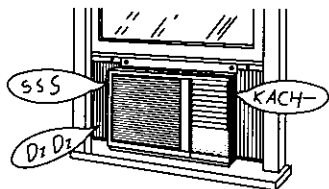

- Normal Operating Sound:
- A soft clicking sound when compressor turns on and off.
 - Refrigerant circulating sound when compressor is turned on.
 - Low humming sound when the unit is in operation.
 - For noise heard other than mentioned above, contact your nearest servicenter.

Water dripping inside the room

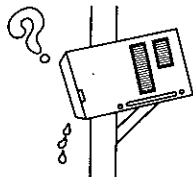

- Unit is tilted inwards; have the unit slightly tilted outwards.
- Mount the drain pan to the unit if you prefer. (Drain pan can be obtained from nearest servicenter - chargeable).

Water dripping outside the room

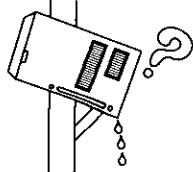

- Condensate water is overflowing.
- Mount the drain pan to the unit. (Drain pan can be obtained from nearest servicenter - chargeable).

PRODUCT SPECIFICATIONS

MODELS			CW-1005FU	CW-1006FU	CW-1205FU	CW-1206FU
COOLING CAPACITY	(Btu/hr)		10,000	10,000	12,000	11,500
ELECTRICAL RATING	Phase		Single			
	Cycle (Hz)		60			
	Voltage (V)		115			
	Current (Amps.)		9.7	8.9	11.7	10.1
	Input (Watts)		1,090	1,000	1,310	1,150
EER	(Btu/Watt•hr)		9.1	10	9.1	10
MOISTURE REMOVAL	(Pints/hr)		3.2	3.2	3.6	3.6
ROOM AIR CIRCULATION	(Cf/min.)		311	311	332	332
DIMENSIONS	Height (Inches)		14-25/32"			
	Width (Inches)		22-1/16"			
	Depth (Inches)		24-1/32"			
NET WEIGHT	(lbs)		88	88	93	93
GROSS WEIGHT	(lbs)		95	95	99	99

*Specifications are subject to change without notice for further improvement.

CUSTOMER'S RECORD



Record the model and serial number from the model label located on the side of cabinet.

This information may be helpful in correspondence or service calls concerning your air conditioner.

Model Number : _____

Serial Number : _____

Dealer Name : _____

Purchase Date : _____

If the trouble persists after you have checked all of these,
call your authorized Panasonic dealer or servicer.
Service information can be obtained 24 hours/day by calling
1-800-545-2672.