

# Panasonic®

## Operating Instructions 使用說明書 Manuel d'utilisation

Electric Thermo Pot  
電子保溫熱水瓶  
Bouilloire thermo électrique

Model No. / 型號 / Numéro de modèle **NC-EH40P**  
**NC-EH30P**  
**NC-EH22P**

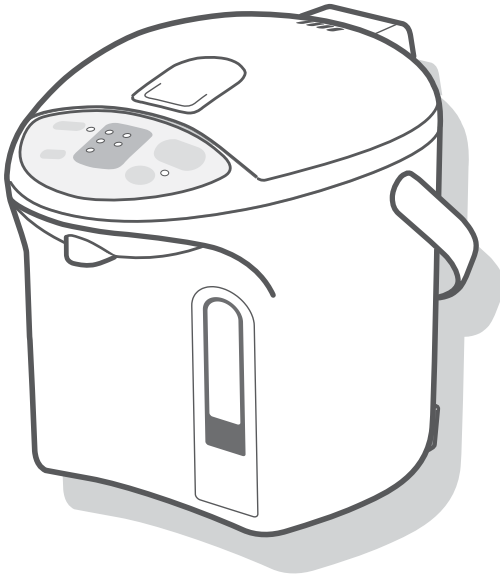

Thank you for purchasing the electric thermo pot, NC-EH40P / NC-EH30P / NC-EH22P. Please read these instructions carefully before using this product and save this manual for future use. This product is intended for household use only.

承蒙您購買NC-EH40P / NC-EH30P / NC-EH22P型號的保溫熱水瓶，衷心感謝。  
請仔細閱讀本使用說明書，正確使用本產品。之後請妥善保管好，以便需要時閱讀。本商品只限家庭用。

Merci d'avoir arrêté votre choix sur une bouilloire électrique, NC-EH40P / NC-EH30P / NC-EH22P. Lire attentivement ces instructions avant d'utiliser ce produit et conserver ce manuel pour une utilisation ultérieure. Pour usage domestique seulement.

# Table of Contents

IMPORTANT SAFEGUARDS .....	4-5
Main Features .....	10
Safety Precautions .....	11-13
Part Names and Handling Instructions.....	14-15
How to Use.....	16-17
Convenient use methods.....	18-19
Daily Maintenance.....	20-21
Troubleshooting.....	22
Replacement of Parts.....	23
Specifications .....	23

# 目錄

重要的安全措施 .....	6-7
主要特點 .....	24
安全注意事項 .....	25-27
各部分名稱和操作方法 .....	28-29
使用方法 .....	30-31
方便的使用方法 .....	32-33
日常保養方法 .....	34-35
故障排除 .....	36
更換易耗品 .....	37
規格 .....	37

# Sommaire

PRÉCAUTIONS IMPORTANTES .....	8-9
Caractéristiques principales .....	38
Consignes de sécurité .....	39-41
Nomenclature et instructions de manipulation .....	42-43
Utilisation .....	44-45
Fonctions pratiques .....	46-47
Entretien .....	48-49
Guide de dépannage .....	50
Remplacement des pièces .....	51
Spécifications .....	51

# IMPORTANT SAFEGUARDS

When using electrical appliances, basic safety precautions should always be followed, including the following:

1. **Read all instructions.**
2. **Do not touch hot surfaces, especially the steam vent. Use handles or knobs.**
3. **To protect against fire, electric shock and personal injury, do not immerse cord, plugs, or Thermo Pot in water or other liquid.**  
**Do not splash water or other liquid over them.**
  - Do not pour water directly from the tap.
  - Do not put the unit in a sink or allow it to get wet.
  - Do not turn the unit upside down when the bottom is wet.
4. **Close supervision is necessary when any appliance is used by or near children.**
  - Do not allow children and persons unfamiliar with the appliance to use it.  
Do not leave the unit within the reach of infants.
  - You must pay special attention to prevent infants from putting the body plug into their mouths.
5. **Unplug from outlet when not in use and before cleaning. Allow to cool before putting on or taking off parts, and before cleaning the appliance.**
  - When unplugging, pull by the power plug - not the cord.
6. **Do not operate any appliance with a damaged cord or plug or after the appliance malfunctions, or has been damaged in any manner. Return appliance to the nearest authorized service center for examination, repair or adjustment.**
  - Never disassemble, repair, or modify the unit.
  - If the supply cord is damaged, it must be replaced by a special cord available from the manufacturer or its service agent.
7. **The use of accessory attachments not recommended by the appliance manufacturer may result in fire, electric shock or personal injury.**
8. **Do not use outdoors.**
9. **Do not let cord hang over edge of table or counter, or touch hot surfaces.**
10. **Do not place on or near a hot gas or electric burner, or in a heated oven.**  
**Do not place on unstable surfaces or surfaces that can be affected by heat, or near walls or furniture.**
11. **Extreme caution must be used when moving an appliance containing hot liquids.**
  - When carrying the unit, do not touch the lid opening lever.
12. **Always attach plug to appliance first, then plug cord into the wall outlet.**
  - Make sure the power plug is correctly inserted in to the wall outlet when in use.
  - Do not connect or disconnect the power plug or the body plug with wet hands.
13. **Use a single outlet that matches the power rating of the unit.**
14. **Clean dust from the power plug or the body plug regularly.**
  - A build-up of dust on the plug will attract condensation, which could cause cable damage resulting in fire. Remove the plugs and clean them with a dry cloth.

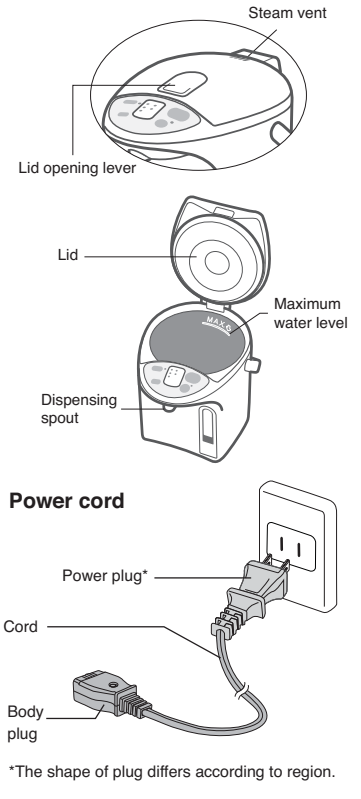

15. Do not allow small metal parts near the body plug.
16. Only use the power cord designed specifically for the unit. Do not use a different cord and do not use this cord with any other device.
17. Do not let the unit fall over.
  - Do not lift, tilt, or shake the unit or carry it by the lid.
    - Even when the dispense key is locked, hot water may leak through the dispensing spout and the steam vent, causing burns, if the unit falls over or is tilted.
18. Close the lid securely, and not by force.
19. Do not throw away the remaining hot water while the lid is attached.
20. When opening the lid, keep hands away from the steam.
21. Do not open the lid or dispense hot water while boiling.
22. Do not pour in water above maximum water level.
23. Do not block the steam vent.
24. Do not rotate the unit while dispensing hot water.
25. Do not use appliance for other than intended use.
  - Do not use to store ice. Condensation will occur, creating a potential source of electric shock and malfunction.
  - Do not heat tea bags, tea leaves, milk, alcohol or anything other than water which may spurt out and cause burns. The water tube may also get clogged, the inner container may burn or corrode, and the fluororesin insulating coating may peel off.

## SAVE THESE INSTRUCTIONS

### Note:

- A. A short cord is provided to reduce the risk of entanglement or tripping over a longer cord.
- B. Extension cords are available and may be used if care is exercised in their use.
- C. If extension cord is used,
  - 1) the marked electrical rating of the extension cord should be at least as great as the electrical rating of the appliance, and
  - 2) the cord should be arranged so that it will not drape over the countertop or tabletop where it can be pulled on by children or tripped over unintentionally.
- D. This appliance has a polarized plug (one blade is wider than the other). As a safety feature, this plug will fit in a polarized outlet only one way. If the plug does not fit fully in the outlet, reverse the plug. If it still does not fit, contact a qualified electrician.
 

Do not modify the plug in any way.

# Main Features

## Taste

- **Boiling with the effects of charcoal coating**

The inner container is fluoridated with flouxy charcoal, which brings out the fine color, taste, and flavor of tea.

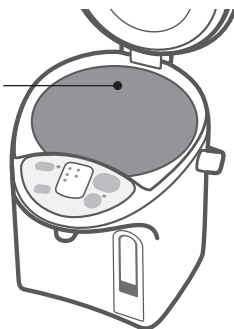

## Convenient

- **Electric dispenser**

(See "Dispense" on P.16-17)

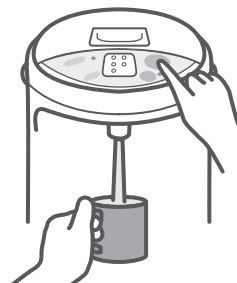

## Economy use

- **6h Timer**

(See "Setting the 6h timer" on P.18-19)

- **4 Keep-warm temperature selections**

208 / 190 / 180 / 140 keep-warm temperature can be selected.

(See "Keep-warm function" on P.18-19)

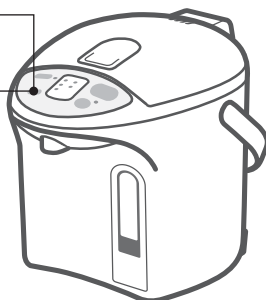

# Safety Precautions

Please observe these precautions fully

For your safety and in order to prevent property damage and the danger to users and others, please read the following instructions.

- The signals indicate harm and damage when the product is used improperly.



## WARNING

Indicating "it may cause severe injuries and death."



## CAUTION

Indicating "the user may get injured or the product may cause property damage."

- The symbols indicate specified items that must be followed.



This symbol indicates prohibition.



This symbol indicates mandatory.



## WARNING

### To Prevent Burns



**This appliance is not intended for use by persons (including children) with reduced physical, sensory or mental capabilities, or lack of experience and knowledge, unless they have been given supervision or instruction concerning use of the appliance by a person responsible for their safety. Children should be supervised to ensure that they do not play with the appliance.**

**Do not let the unit fall over. Do not lift, tilt or shake the unit or carry it by the lid.**

Even when the dispense key is locked, hot water may leak through the dispensing spout and the steam vent, causing burns, if the unit falls over or is tilted.

**Do not pour in water above the maximum water level indication line. If the appliance is overfilled, boiling water may be ejected.**

Hot water can spill causing burns.

**Do not close the lid by force.**

Hot water can spill causing burns.

**Do not boil anything other than water.**

Do not heat tea bags, tea leaves, milk, alcohol or anything other than water which may cause it to spurt out hot liquid or steam and cause burns.

The water tube may also get clogged, the inner container may burn or corrode, and the fluororesin insulating coating may peel off.

**Do not block the steam vent.**

Hot water can overflow causing burns.

**Do not throw away the remaining hot water while the lid is attached.**

If the lid comes off, hot water may splash causing burns.

**Do not touch the steam vent.**

This may cause burns. Take special care to prevent infants from touching the steam vent.

**Close the lid securely.**

If the unit topples, hot water may spill out causing burns.

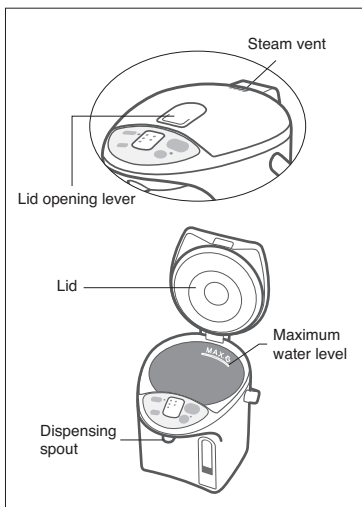

# Safety Precautions

Please observe these precautions fully



## WARNING

### Power Cord



**Never do anything that might cause damage to the cord, power plug or body plug,** such as damage them, modify them, place hot objects near to them, bend them, twist them, stretch them, place heavy objects on them, or bundle them together. If the unit is used when damaged, electrical short circuit or fire may result.

- If the supply cord is damaged, it must be replaced by a special cord available from the manufacturer or its service agent.

**Do not connect or disconnect the power plug or the body plug with wet hands.**

This may result in electric shock.

### Power cord

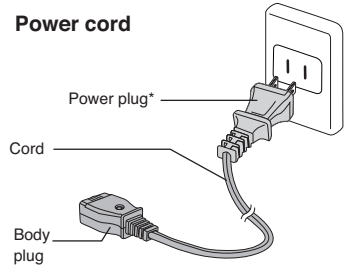

\*The shape of plug differs according to region.



**Make sure the power plug is correctly inserted into the wall outlet.**

If the plug is inserted improperly it may cause electric shock or generate heat resulting in fire.

- Do not use a damaged plug or a connection in a loose outlet.

**Clean dust from the power plug or the body plug regularly.**

A build-up of dust on the plug will attract condensation, which could cause cable damage and the deterioration of insulation resulting in fire.

- Remove the plugs and clean them with a dry cloth.

**Use a single outlet that matches the power rating of the unit.**

Heat generated when plugging in multiple appliances into one outlet may result in fire.

### During use



**Do not immerse the unit in water or splash water over it.**

- Do not supply water directly from the tap or place the unit in a sink where the bottom may get wet.
  - Do not turn the unit upside down when the bottom is wet.
- It may cause a short circuit and may result in electric shock, and if water overflows from the pot and it enters the electrical parts built into the main unit, it may cause malfunction.

**Never disassemble, repair or modify the unit.**

Any attempt to do so may cause the unit to operate abnormally and may result in fire or injury.

- If in need of repair (except for the replacement parts), please contact an authorized Service Center.

**Do not use to store ice.**

Condensation will occur, creating a potential source of electric shock and malfunction.





## CAUTION

### To Prevent Burns



**Do not place the unit on unstable surfaces.**  
The appliance may topple over causing burns.

**Do not open the lid or dispense hot water while boiling.**  
Splashing hot water or steam may cause burns.

**Do not rotate the unit while dispensing hot water.**  
Splashing hot water may cause burns.

**Do not touch the hot parts of the unit during use or shortly after use.**  
This may cause burns.



**When carrying the unit, do not touch the lid opening lever.**  
The lid may open causing burns and other injury.

**Wait until the unit is cooled down before maintenance.**  
A hot appliance may cause burns.

- When disposing hot water, be careful not to get burned.

**When opening or closing the lid, keep hands away from the steam.**  
Steam can cause burns.

### Power Cord



**Do not use other than the power cord designed specifically for the unit.**  
**Do not use a different cord and do not use this cord with any other device.**  
It may cause malfunction or fire.



**When the unit is not in use, unplug the power plug from the wall outlet.**  
Deteriorating insulation may result in electric shock and/or fire.

**When unplugging the unit, pull by the power plug - not the cord.**  
Electric shock and short circuit may result in fire.

### During use



**Do not use the unit on surfaces that retain heat for a long time.**  
The unit may get discolored or break up.

**Do not place near walls or furniture.**  
Steam and heat could damage walls and furniture, causing a change in color and shape.

# Part Names and Handling Instructions

## Operation panel

If the protective film is still covering the surface of the operation panel, peel it off before using the operation panel.

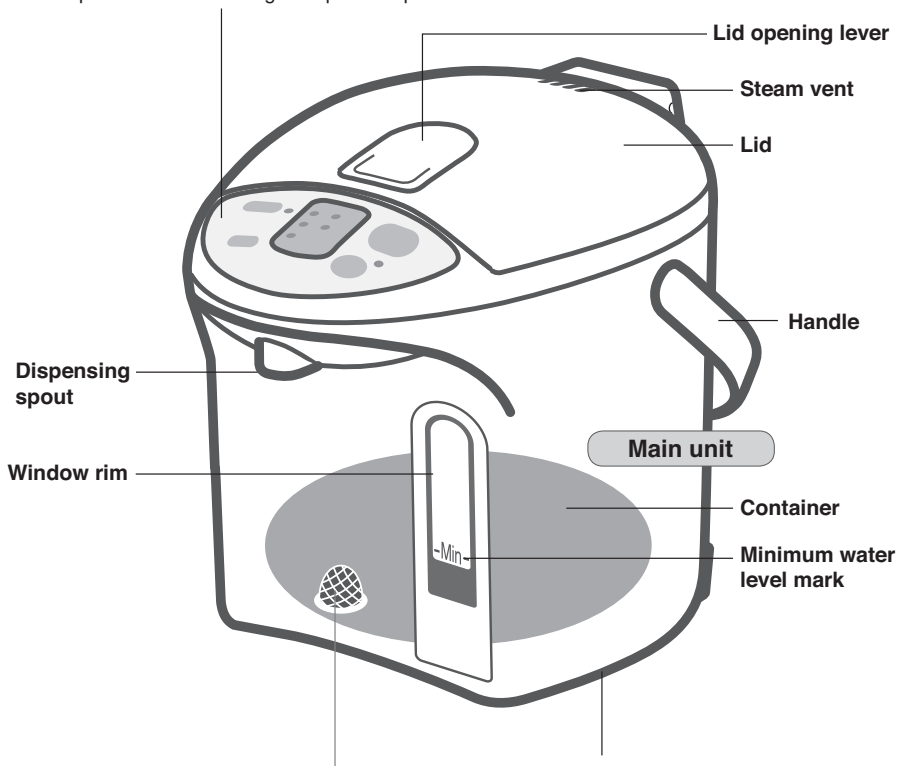

## Mesh filter

### (Replaceable part)

It may have come off from the bottom of the container. Push it completely into the correct position. (See P.20)

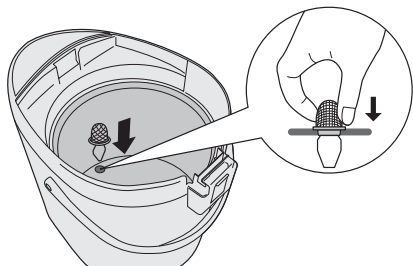

## Rotating base (360 degrees)

When rotating the pot, do not allow the cord to wind around the unit.

## Power cord

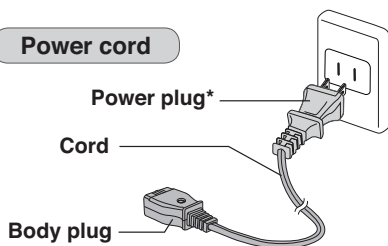

\*The shape of plug differs according to region.

## How to Open/Remove

To open, press the depression in the opening lever, and lift the lid.

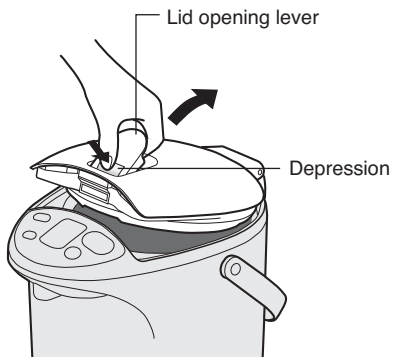

### To close

Press down on the lid until it clicks.

To remove, push on the lid release lever, hold the lid opening lever, and pull the lid out and up diagonally.

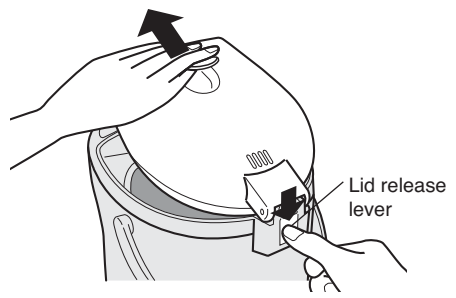

### To attach

Insert the lid at an angle.

## Overheating Protection

If an empty container is heated, the overheat safety function (which prevents an empty container from being heated) will be activated. The power will be shut off automatically to prevent the problems that may occur due to overheating.

Overheating, the display shows LEDs flashing alternately

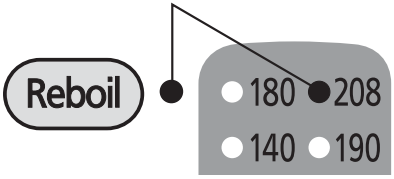

### Cause

- Less than the minimum water level in the container was boiled.
- After water is added, the lid might be left open.

### How to cancel the display

Pour water into the container, and press the **Reboil** key.

### Notice

If an empty container is heated, an odor will be emitted and the container may be discolored.

# How to Use

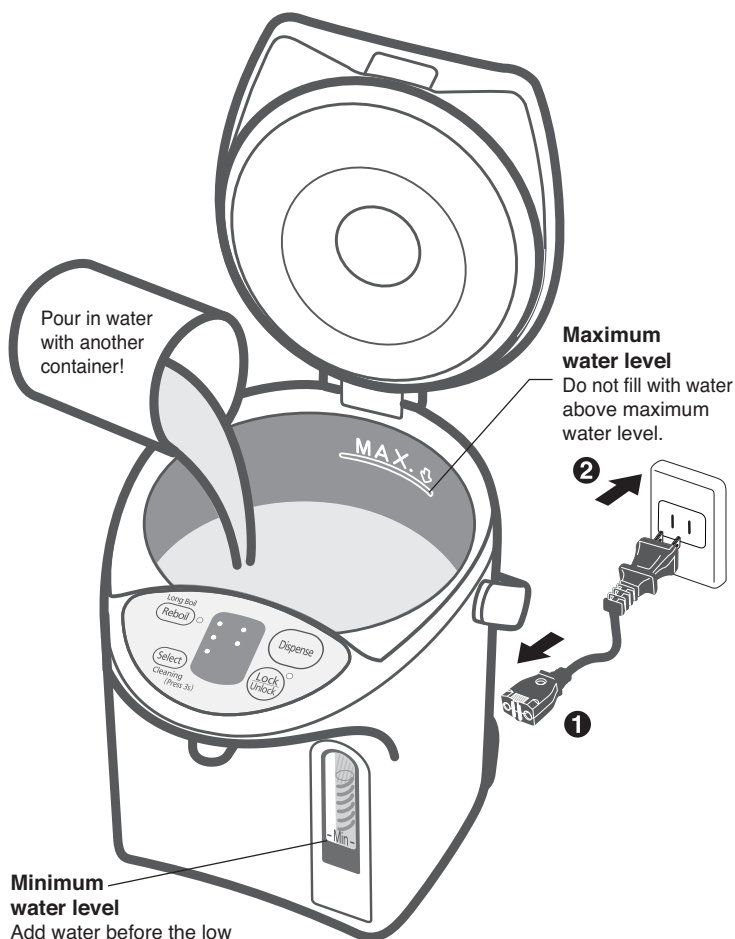

Boiling water

Dispense  
(Electric dispenser)

## Before you use this pot for the first time

Boil water in it to clean the thermo pot container and the sections through which the hot water is dispensed.

- 1 **Boil some water.**
- 2 **Dispense the hot water.**
- 3 **Empty the container via "DRAIN" mark. (See P.17)**

## To reduce the chlorine in the water (Long Boil)

Press **Reboil** key to make the indicator light flash.

( Press one time while water is being boiled, and )  
( press twice while water is being kept warm. )

Extends the boiling time by about 6 minutes to reduce the chlorine in the water.

- Press **Reboil** key again to boil.

Pour in water with another container. Close the lid securely.

**Securely plug the body plug horizontally into the body.**

**Plug into wall outlet. (1) → (2)**

Water starts boiling automatically.



After the water has been boiled, the following will be indicated.



The boiled water will be kept warm at approx. 190°F (90°C) automatically.

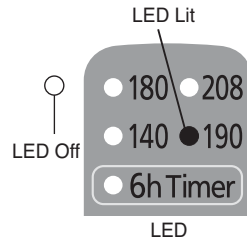
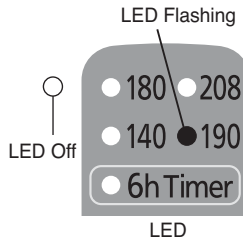
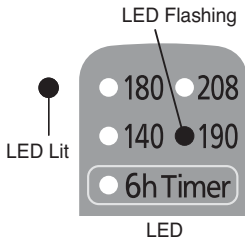

#### Time required to boil water (approx.)

NC-EH40P: 35 min. / NC-EH30P: 27 min. / NC-EH22P: 20 min.

(Amount of water: Maximum Water / Room temperature: 68°F (20°C))

- The indication is estimated water temperature.

Press the  key to release lock. The indicator light beside the key will be lit.



Press  key and dispense the hot water.

The "Dispense" key will be re-locked automatically in 10 seconds after you stop dispensing hot water.



#### When the unit is not in use

**Unplug, and remove the lid. Pour out any remaining hot water slowly via the **DRAIN** mark.**

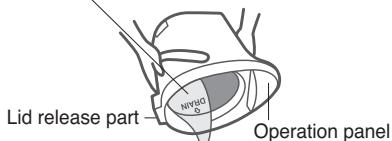

#### Cautions

- Do not pour out water too quickly. (If water splashes over lid release part or operation panel, it may cause a malfunction.)
- Do not leave water standing in the container. (It may cause the container to corrode or smell.)

# Convenient use methods

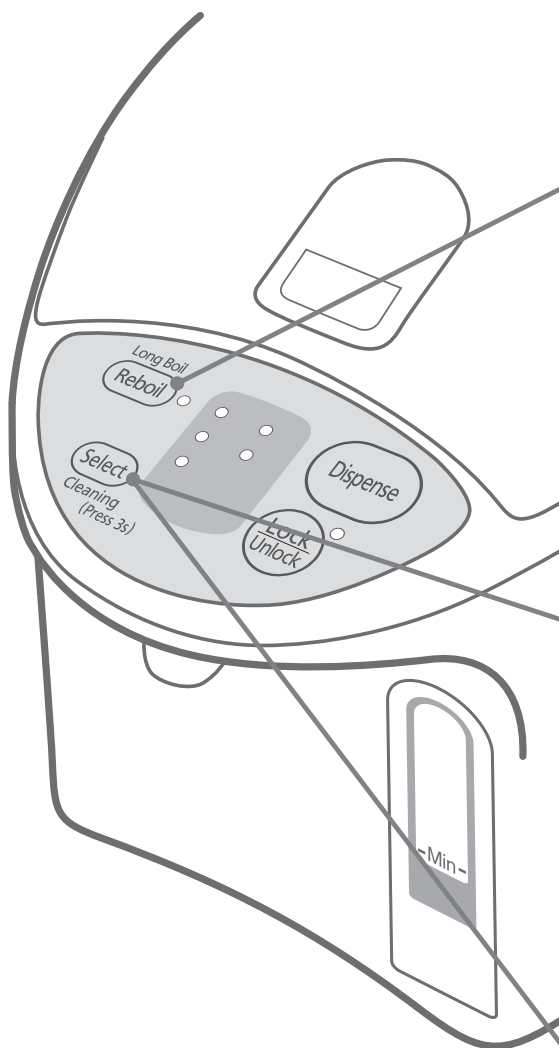

## Reboil

- It is ideal to use boiling water for making coffee / tea / instant cup noodles etc.

## Keep-warm Function

- It is ideal to use 180 keep-warm for making green tea.
- It is ideal to use 140 keep-warm for preparing milk for a baby. Be sure to leave milk to cool down or mix it with cool boiled water before giving it to a baby.

When the unit will not be used for a short time, such as when you go out for a day...

## Setting the 6h timer

- While setting the timer, the electrification of heater stops

### Notice

- The keep-warm temperature or the timer can be set while the water is being boiled or being kept warm.
- After power is restored in the event of a power failure, the keep-warm temperature will be automatically set to 190, even if the timer or the "208", 180" or "140" keep-warm function was previously selected.

Press the **Reboil**  key to reboil water that is being kept warm.

After a few minutes, water will be boiled.

- The keep-warm temperature setting is left unchanged.

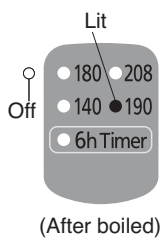

**Time required for the reboil procedure**  
 From 208 keep-warm : approx. 2.5-4 min.  
 From 190 keep-warm : approx. 4-6.5 min.  
 From 180 keep-warm : approx. 6-12 min.  
 From 140 keep-warm : approx. 9-17.5 min.  
 ( Amount of water: Maximum  
 Room temperature: 68°F (20°C) )

Press the **Select** key.

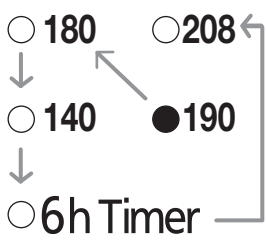

Each time the key is pressed, "●" mark will shift to the next choice and change the keep-warm temperature or set the timer.

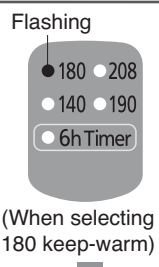

**Time required to reach the setting keep-warm temperature**  
 190 → 208 keep-warm : approx. 2-3 min.  
 190 → 180 keep-warm : approx. 0.5-1 hour  
 190 → 140 keep-warm : approx. 3.5-4.5 hours  
 ( Amount of water: Maximum  
 Room temperature: 68°F (20°C)  
 Previous keep-warm setting: 190 )

(When selecting 180 keep-warm)

After a short time, water will be kept warm at the settled temperature (The lamp will be lit).

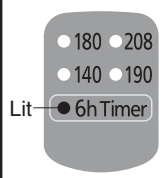

**6 hours later, timer will go off and water starts boiling**

When the water is brought up to boiling temperature, it will be kept warm at 190°F (90°C).

# Daily Maintenance

(Before cleaning, be sure to disconnect the plug from the outlet, dispense water and allow to cool the unit.)

## Main unit and lid

### Clean with a damp, well-wrung cloth.

- Do not wet or soak the main unit in water.
  - If water enters the main unit from the bottom or from the dispensing spout, it can also get into the electrical components in the main unit and may cause a malfunction.
- Do not use detergents. (They may leave an odor.)
- Do not use benzine or thinner. (They may damage the surface.)



## Inner container

### Clean with a wet sponge.

- Do not use polishing powder, a scrub brush or a nylon brush.
  - They may damage the fluororesin finish of the inner container.



## About "Scale"

While you are using this unit, minerals contained in the water (like calcium) can get stuck on the inner container or on the mesh filter. This is called "scale", and it is harmless.

- Milky-white gritty surface (caused by calcium)
- White or glittering floating material (crystals of minerals)
- Discoloration in the finish like dark brown, gray, or green areas (metallic ion made on the fluororesin covering)

These are not discoloration or corrosion of the inner container itself, nor are they flakes from the fluororesin covering.



**Clean the inner container using citric acid. (See P.21)**

## Mesh filter

### Clean the filter with a brush.

When filter is clogged, water does not flow smoothly.

- \* After cleaning the filter, be sure to reattach it to the inner container.

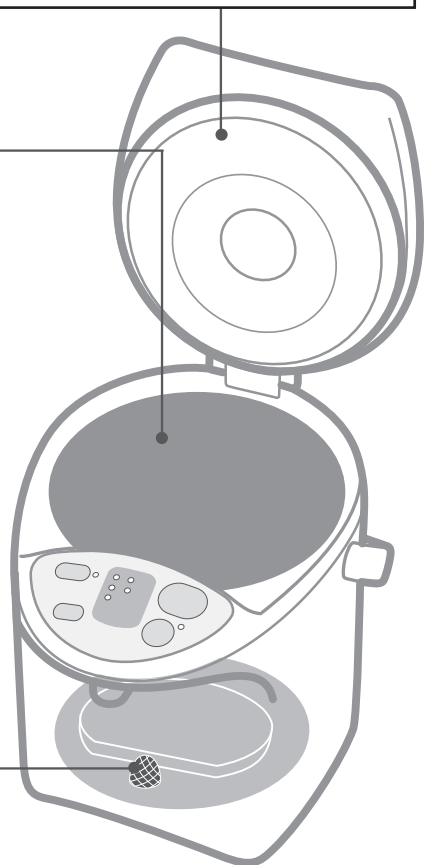

## When storing the unit

- Dry it thoroughly.
- Put it into a plastic bag and seal the bag.



**1 Make sure that the mesh filter is attached to the container.**

**2 Put citric acid in the inner container.**

- Amount of citric acid to be used at one time:  
80 g (two packages) or seven level tablespoons.

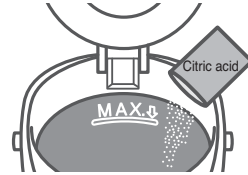

**The citric acid is available from an authorized dealer. (Model No: SAN-80N)**

- \* Follow the directions for cleaning printed on the citric acid package.
- \* Since the citric acid used for cleaning is a food additive, it is harmless to humans.

**3 Add water to the maximum water level mark, and mix the citric acid and water well. Close the lid.**

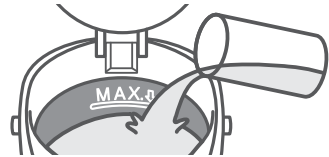

**4 Connect the plug immediately after stirring and press the **Select** key more than 3 seconds.**

**Cleaning start**

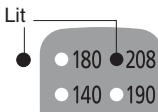

**Cleaning time (approx.)**  
 NC-EH40P: 50 Min.  
 NC-EH30P: 42 Min.  
 NC-EH22P: 35 Min.

**End of cleaning**

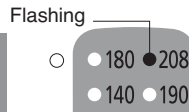

Indications will note when cleaning ends.

**5 Dispense some water, then unplug, remove the lid and throw away the hot water via the "DRAIN" mark.**

**6 Refill with water and boil it to remove the smell of the citric acid or lemons. Then throw the hot water away in the same way as in step 5.**

- To remove any discoloration from the area above the maximum water level, rub the inside lightly with a wet sponge.
- If the discoloration cannot be removed by rubbing, clean the inner container several times using citric acid or lemons.

**Cautions**

- Use only our citric acid to clean this thermo pot.
- Do not fill with water above maximum water level.
- Fill the container only with tap water (do not fill with hot water). Hot water may spout out causing burns.

# Troubleshooting

Before calling a service supplier, please check the following possible causes/soluting.

If...	Possible cause	Causes/Solutions
White or glittering flakes floating in the hot water.	<ul style="list-style-type: none"> <li>The cause of this is "scale". (See P.20) It is not flakes of fluororesin.</li> <li>* Water with a large content of minerals in it such as mineral water or ionised water, is more likely to cause a scale or white layer in the hot water.</li> </ul>	<ul style="list-style-type: none"> <li>Clean the inner container with a wet sponge. (See P.20)</li> <li>If the "scale" still remains, clean with citric acid. (See P.21)</li> </ul>
Boiling sounds become louder.	<ul style="list-style-type: none"> <li>When "scale" adhered, boiling sounds become louder.</li> </ul>	
Hot water has odors of chlorine.	<ul style="list-style-type: none"> <li>Odors of chlorine remain depending on the amount of chlorine in tap water.</li> </ul>	<ul style="list-style-type: none"> <li>Press the "Reboil" key to reduce the chlorine. (See P.16)</li> </ul>
Hot water has an unpleasant odor.	<ul style="list-style-type: none"> <li>When the unit is new, resin used in the manufacturing process may give off a mild odor.</li> <li>If the unit is placed on surfaces such as a vinyl sheet, the odor may be carried over into the water.</li> </ul>	
Hot water comes out by itself.	<ul style="list-style-type: none"> <li>Water has been added above maximum water level.</li> </ul>	<ul style="list-style-type: none"> <li>Lower the water level.</li> </ul>
Hot water does not flow out smoothly.	<ul style="list-style-type: none"> <li>The mesh filter may be clogged with "scale". (See P.20)</li> </ul>	<ul style="list-style-type: none"> <li>Clean the filter with a brush.</li> <li>If the "scale" cannot be removed, replace the filter. (See P.23)</li> </ul>
The indicator lights flash alternately.	<ul style="list-style-type: none"> <li>Overheating protection has been activated (See P.15)</li> </ul>	<ul style="list-style-type: none"> <li>Add water and press the "Reboil" key.</li> </ul>
	<ul style="list-style-type: none"> <li>The indicator lights may flash alternately by adding boiling water or due to the way the water is supplied.</li> </ul>	<ul style="list-style-type: none"> <li>Press the "Reboil" key.</li> </ul>
	<ul style="list-style-type: none"> <li>When the inner container is cleaned with citric acid, citric acid may have built up on the bottom.</li> </ul>	<ul style="list-style-type: none"> <li>Disconnect the plug, and stir the citric acid well to disperse.</li> </ul>
Hot water does not dispense.	<ul style="list-style-type: none"> <li>The automatic lock has been engaged.</li> </ul>	<ul style="list-style-type: none"> <li>Press the "Lock/Unlock" key.</li> </ul>

- If the problem is not fixed after checking the above possible causes, or if you still think something is wrong, disconnect the body plug from the unit. Wait at least 10 seconds and then re-connect the plug.
- The semi-transparent inner part inside the lid may become yellowish. This does not affect operation of the unit.
- The rattling noise in the lid is made by small ball-shaped components which prevent water from flooding out if the unit topples over.
- If the room temperature is very high, the outside of the main unit may reach about 131°F (55°C).

The unit does not turn on.	<ul style="list-style-type: none"> <li>You poured in water directly from a tap.</li> </ul>	<ul style="list-style-type: none"> <li>It is broken if the electric components are taken in water. Contact the stores where you purchased for repair.</li> </ul>
	<ul style="list-style-type: none"> <li>You put the unit on the sink.</li> </ul>	
	<ul style="list-style-type: none"> <li>You turned the unit upside down with its bottom wet.</li> </ul>	
	<ul style="list-style-type: none"> <li>You washed the unit water.</li> </ul>	

# Replacement of Parts

## Rubber gasket set

Replace gaskets if they crack, lose their pliancy or, for any other reasons which allow steam to escape from between the container and the lid

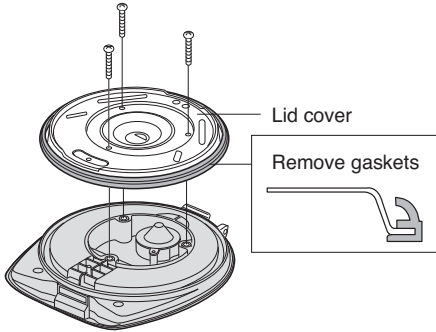

Remove lid, unscrew 3 tapping screws and remove the lid cover.

Exchange the gaskets and then place the lid cover back and secure with the tapping screws.

## Mesh filter

Replace the filter, if foreign materials which clogging the filter cannot be removed, even after scrubbing with a cleaning brush, etc.

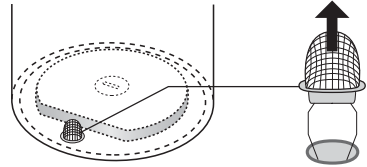

The filter can be removed by pulling firmly on it.

Consumable parts are available from an authorized dealer.

Part name	Part No.
Rubber gasket set	APH65-480
Mesh filter	APB97-480-0U

# Specifications

Model No.		NC-EH40P	NC-EH30P	NC-EH22P
Power supply		120 V a.c.		
Power consumption		700 W		
Average power consumption in keeping warm (approx.) (Amount of water: maximum Room temperature: 68°F (20°C))	at 208	49 Wh	45 Wh	40 Wh
	at 190	43 Wh	39 Wh	33 Wh
	at 180	35 Wh	31 Wh	27 Wh
	at 140	23 Wh	21 Wh	18 Wh
Dimensions (when the handle is tilted)	Height (approx.)	12.8 in (32.4 cm)	10.8 in (27.5 cm)	9.4 in (23.8 cm)
	Width (approx.)	8.5 in (21.7 cm)	8.5 in (21.7 cm)	8.5 in (21.7 cm)
	Depth (approx.)	11.3 in (28.7 cm)	11.3 in (28.7 cm)	11.3 in (28.7 cm)
Weight (including power cord) (approx.)		4.6 lb (2.1 kg)	4.4 lb (2.0 kg)	4.2 lb (1.9 kg)
Rated capacity (approx.)		4.2 qt (4.0 L)	3.2 qt (3.0 L)	2.3 qt (2.2 L)

\* Under certain conditions, such as at very high altitudes and in intense cold, the unit may not function properly. Please avoid using in such conditions.

\* If the unit is not being used in cold conditions, make sure to empty it of water. The water left in the inner container may freeze causing damage.

Panasonic Corporation of North America  
USA : <http://www.panasonic.com/consumersupport>  
CANADA : <http://www.panasonic.ca>

PZ05A6101  
SP1107M0