

This Owner's Manual is provided and hosted by [Appliance Factory Parts](#).

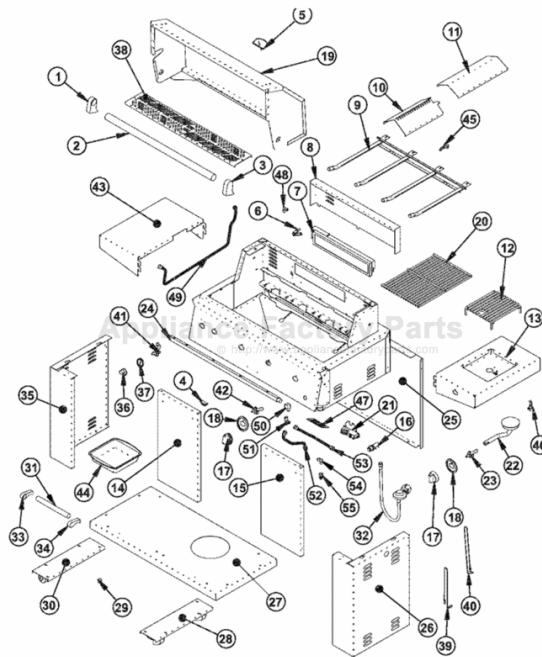

FRIGIDAIRE FD38HONGDC Owner's Manual

[Shop genuine replacement parts for FRIGIDAIRE
FD38HONGDC](#)



[Find Your FRIGIDAIRE Grill Parts - Select From 30 Models](#)

----- Manual continues below -----

Use & Care Manual











Assembly Instructions Included

38" Stainless Steel Outdoor Grill

with Electronic Ignition



Visit the Frigidaire Web Site at:
<http://www.frigidaire.com>

Welcome/Product Registration ...	1	
General Safety Instructions	2	
Grill Features & Components	3-4	
Grill Assembly Built-In Instructions	5-12	
Gas Requirements Leak Testing	13-15	
Using the Grill Rotisserie/Side Burner Usage	16-19	
Lighting the Grill.....	17	
Care & Maintenance	20	
Before You Call Trouble Shooting	21-22	
Warranty.....	23	



Welcome & Congratulations

Congratulations on your purchase of a new gas grill! At **Electrolux Home Products**, we are very proud of our product and are completely committed to providing you with the best service possible. Your satisfaction is our number one priority.

We know you'll enjoy your new gas grill and **Thank You** for choosing our product. We hope you consider us for future purchases.

PLEASE CAREFULLY READ AND SAVE THESE INSTRUCTIONS

This Use & Care Manual provides specific operating instruction for your model. Use your gas grill only as instructed in this manual. These instructions are not meant to cover every possible condition and situation that may occur. Common sense and caution must be practiced when installing, operating and maintaining any appliance.

Questions? 1-800-320-0859

Please record Grill information for future reference and service work:

Model #: _____

Serial #: _____

Date of Purchase: _____

Gas Type: _____

Please retain this manual for future reference

© 2004 Electrolux Home Products, Inc All rights reserved

General Safety Instructions



IMPORTANT SAFETY INFORMATION

- Read this manual carefully before using your grill to reduce the risk of fire, burn hazard or other injury.
- Extreme care should be used because of the high temperatures produced by this appliance. **CHILDREN SHOULD NOT BE LEFT UNATTENDED IN AN AREA WHERE THE GRILL IS BEING OPERATED.**
- This appliance must be kept clear from combustible materials, gasoline or other flammable vapors and liquids. Do not allow flammable materials to come in contact with grate, burner or hot surfaces.
- Do not repair or replace any part of this appliance unless it is specifically recommended in this manual. A qualified service technician should conduct all other service.
- Follow the installation and servicing instructions provided with this product. Have your grill installed by a qualified service technician. Locate the main gas supply valve so that you know how to shut the gas off to your grill. If you smell gas, make sure all gas connections are tight before operation. If you continue to smell gas call a qualified technician.
- When lighting a burner, always pay close attention to what you are doing. Be certain you are pushing the ignitor that lights the burner you intend on using.

FOR YOUR SAFETY

If you smell gas:

1. Shut off gas to the appliance.
2. Extinguish any open flames.
3. Open lid.
4. If odor continues, immediately call your gas supplier.

CALIFORNIA PROPOSITION 65 - WARNING: The Burning of gas cooking fuels generates some by products which are on the list of substances which are known by the State of California to cause cancer or reproductive harm. California law requires businesses to warn customers of potential exposure to such substances. To minimize exposure to these substances, always operate this unit according to the use and care manual, ensuring you provide good ventilation when cooking with gas.

This appliance is not intended to be installed in or on recreational vehicles or boats.

FOR OUTDOOR USE ONLY

TESTED IN ACCORDANCE WITH ANSI Z21.58b-2002/CGA 1.6b-M02 STANDARD FOR OUTDOOR COOKING GAS APPLIANCES. THIS GRILL IS FOR OUTDOOR USE ONLY.

Check your local building codes for the proper method of installation. In the absence of local codes, this unit should be installed in accordance with the National Fuel Gas Code No. Z223.1-2002 and the National Electrical Code ANSI/NFPA No. 70-1990

FOR YOUR SAFETY

DO NOT store or use gasoline or other flammable vapors and liquids in the vicinity of this or any other appliance.

An LP cylinder not connected for use shall not be stored in the vicinity of this or any other appliance.

WARNING

DO NOT try lighting this appliance without reading the “**LIGHTING INSTRUCTIONS**” section of this manual.



Grill Features: FD38

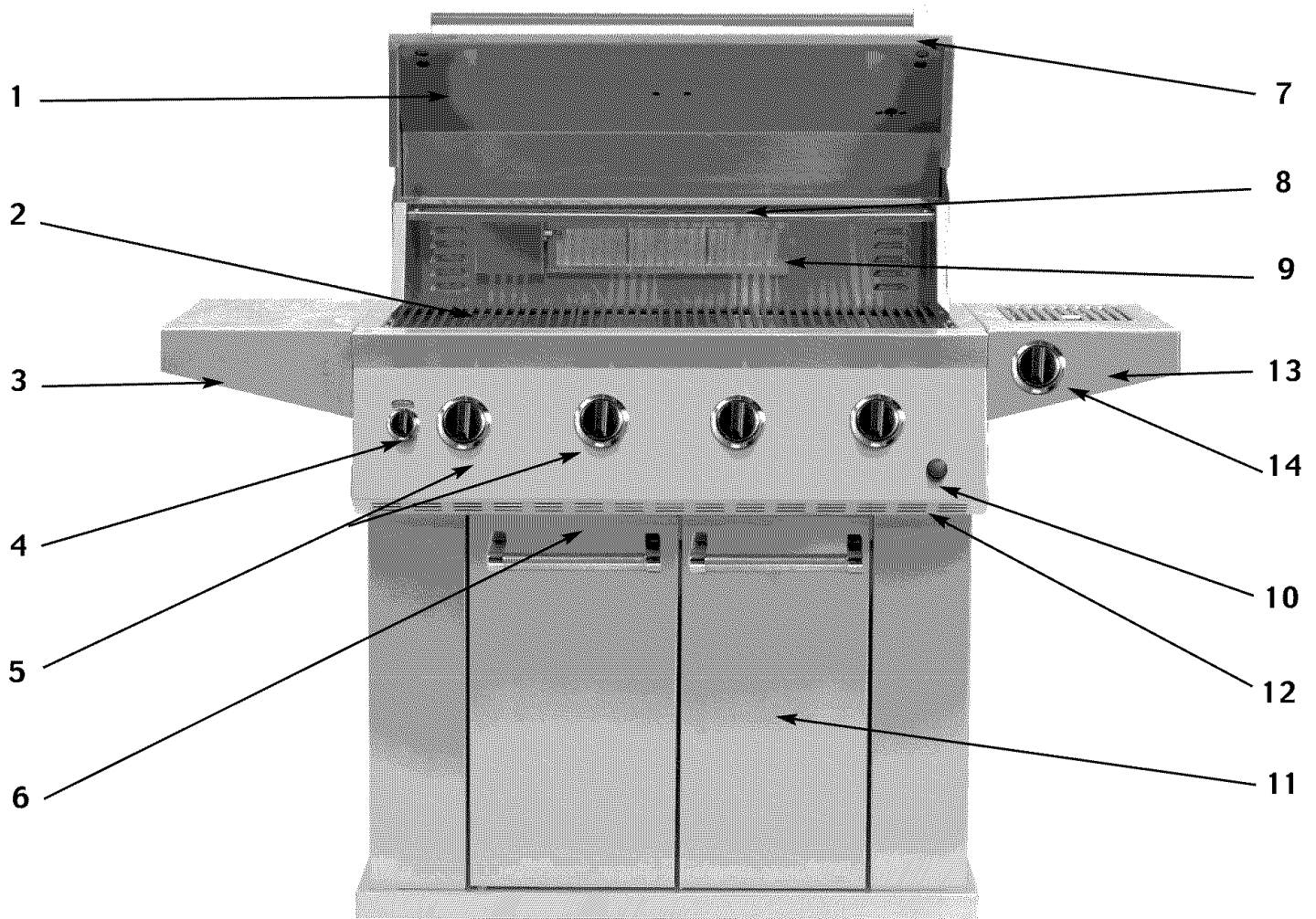

- | | | | |
|----|------------------------------------|-----|---|
| 1. | Roll top grill hood | 8. | Warming shelf |
| 2. | Grilling/Cooking surface | 9. | Infrared back burner |
| 3. | Side Shelf | 10. | Electronic ignitor: main, rear infrared & side burner |
| 4. | Control knob: back infrared burner | 11. | Cart w/doors |
| 5. | Control knobs: main burners | 12. | Ignitor access opening |
| 6. | Convection vents | 13. | Side Burner |
| 7. | Handle | 14. | Control knob: side burner |

Grill Components List

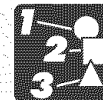

Cart Parts

2	L-shaped side pieces	WIP-192-71D384
1	U-shaped back side piece	WIP-192-72D384
1	Base	WIP-192-70D384
2	Wheel channels	WIP-192-438365L/R

Cart Door Parts

2	Doors Handle Kits	RMP-122-00921
2	Nylon bushings	RMP-122-00520
2	Door pivot screws and nuts	RMP-122-00598/122-00508

Grill Parts

1	Stainless steel grill head	WIP-122-11D384
1	Stainless steel side shelf	WIP-192-326393
1	Side burner (side shelf)	WIP-191-43DGN4
1	Electronic ignitor	RMP-122-53306
7	Flavor grids	WIP-191-13D384
3	Stainless steel bar grates	RMP-122-00699
1	Stainless steel warming rack	WIP-191-538015
1	Drip pan	RMP-122-00005
2	Magnetic catches	RMP-122-00029
1	Hose and regulator (LP models only)	RMP-122-00821

Grill Parts

Assembly Parts

16	Hex head screws	RMP-122-00615
8	Bolts	RMP-122-00626
2	Rubber Door Stops with Bolts	RMP-122-00579
1	1 1/4" Plastic Plug	RMP-122-00492

Assembly Parts



Grill Assembly

Note: Prior to assembly remove protective film from stainless steel parts

Assembly requires: 4 tools and a Friend

Tools required:

**Power screwdriver
Screwdriver extension
1/4" socket wrench
1/2" socket wrench
adjustable wrench
scissors**

Caution: Gas regulator is not flush with bottom. **DO NOT** let the Grill head sit flat without placing support around regulator to prevent damage to the regulator prior to installing on cart.

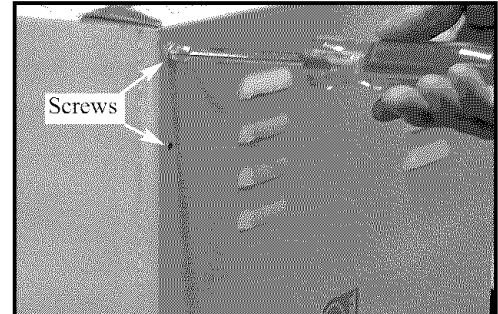

Fig. 1

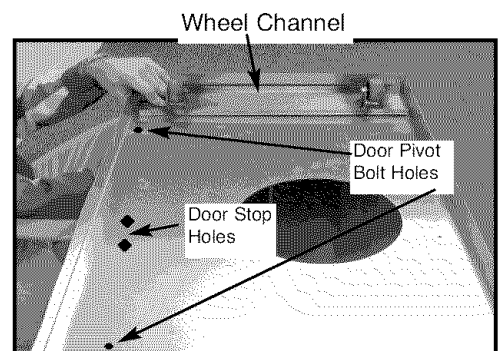

Fig. 2

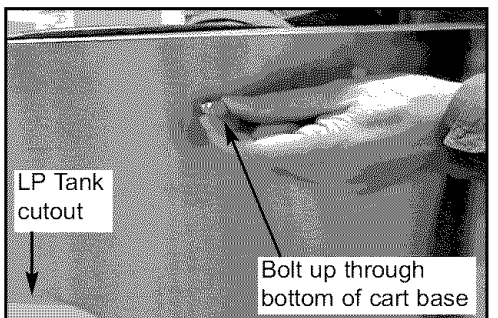

Fig. 3

Cart Assembly, Door Stops & Door Pivot Bolts

1. Attach the two L-shaped sides to the back portion of the cart, making sure the two holes face up & the key holes are on the top, using the (4) self tapping hex head screws. (See Fig. 1)

Note: A power screwdriver is required to install the screws-be cautious not to over-tighten and strip the screws.

2. Set the base on the top of the cart assembly, with large opening closer to back portion of cart, and align the eight mounting holes. Then set the 2 wheel channels on the base and attach them using the (8) bolts provided, from inside the cart upwards through wheel channels. (See Fig. 2)

Note: Tighten the bolts securely

3. **Door Stops:** Insert Door Stop Bolts downward from bottom side of Cart Base through the hole found in the middle/front of the base. (See Fig 3)
4. Screw Rubber Caps onto Bolts from the topside of Cart Base and tighten securely. (See Fig 4)
4. **Door Pivot Bolts:** Insert Bolts downward from bottom side of Cart Base through the holes found in the left & right/front of the base and secure with bolt. (See Fig. 2)

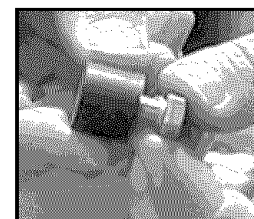

Fig. 4

Grill Assembly



Attaching Grill Head to Cart

1. While keeping the Grill on the foam base lean it onto its back. (be sure to hold the hood shut when doing this.) With the Grill on its back, loosen all 4 bolts on the bottom side of the Grill, but do not remove. (See Fig. 5)
2. Using 2 self tapping hex head screws, attach the magnetic door catch in the 2 holes in the bottom of the grill. (Repeat for second door catch) (See Fig. 6)
3. Have someone help you pick up the grill and set it on the top of the cart, with the **front** of the grill above the door opening. Make sure the 4 bolt heads fall through the large opening of the key hole slots in the top of the cart. Slide the grill head **backward**, so the bolts are resting in the small opening of the key hole slots. Tighten the bolts securely. **Be sure not to over tighten and strip the bolts.** Next insert 4 hex head screws into grill bottom through cart. (See Fig. 7)

Note: This is a very heavy step that requires two individuals to complete.

Installing the Cart Door

1. While holding the door line up the bottom hole on the door with the bolt sticking up through base of cart. Next place a nylon bushing onto the top pin, then depress the pin and insert into the hole in the bottom of the grill. (See Fig. 8)

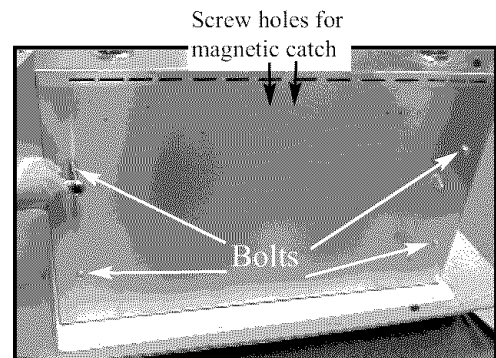

Fig. 5

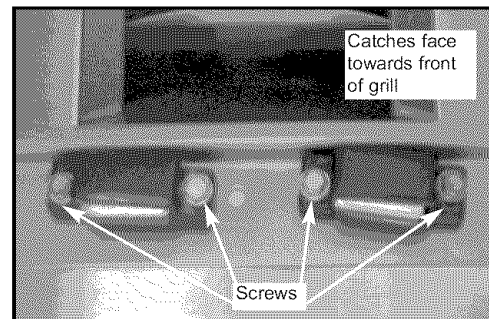

Fig. 6

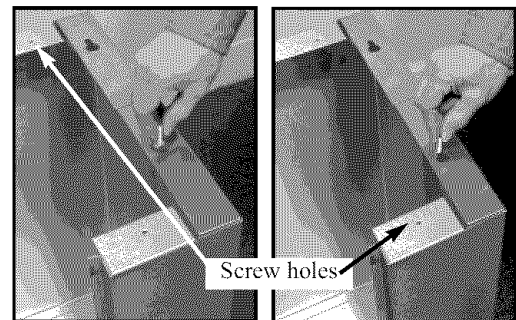

Fig. 7

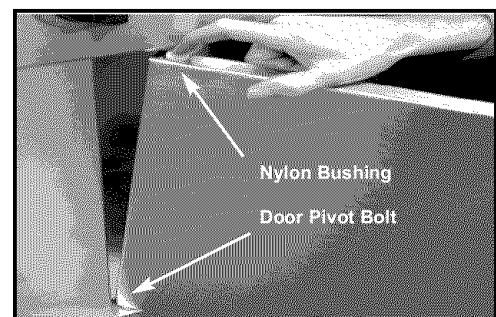

Fig. 8



Grill Assembly

Installing the Cart Door Handles

1. Using a 5/32" allen wrench insert 1 screw through the inside of the door front into a bar handle end and tighten securely. (See Fig. 9)
2. Insert Bar Handle into the End Cap attached to the door and then into the other End Cap and tighten End Cap with allen wrench and screw. (See Fig. 10)
3. Complete Door. (See Fig. 11)
4. Repeat above steps for the second door.

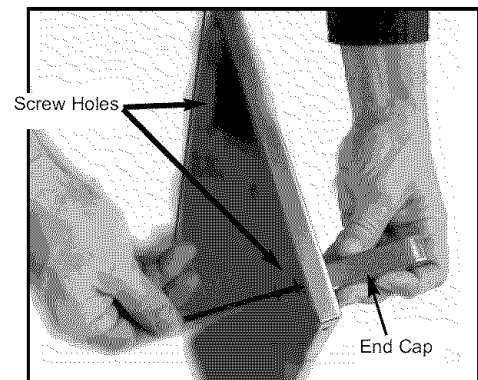
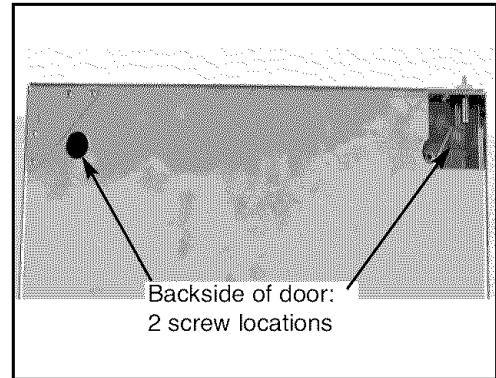

Fig. 9

Installing the Drip Tray

1. The drip pan is installed inside of the cart under the grill head.
2. Slide the drip pan onto the two ledges located on the bottom of the grill, by inserting it from the left side of the cart. (See Fig. 12)

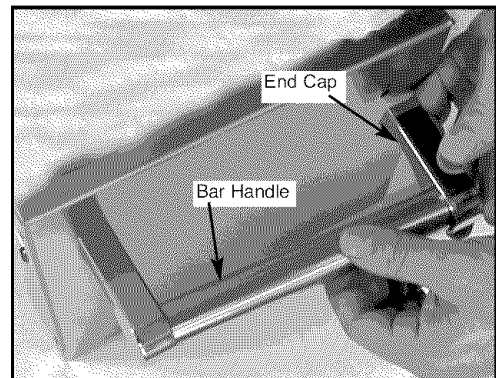

Fig. 10

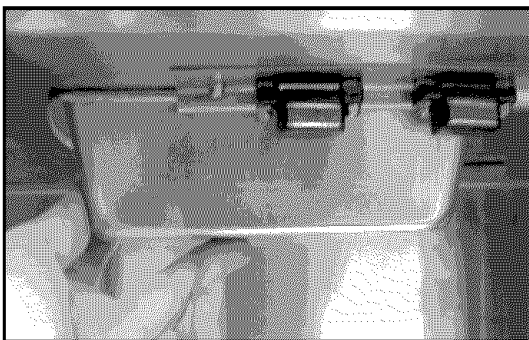

Fig. 12

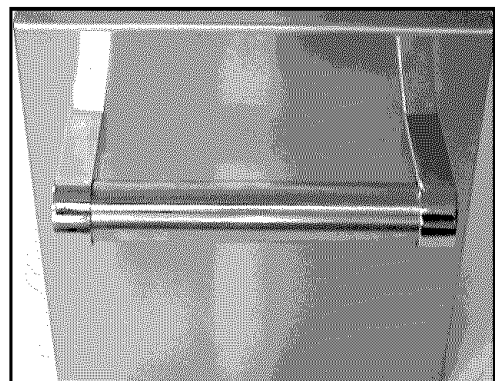

Fig. 11

Grill Assembly



Side Shelf Attachment

1. Attach the shelf to the left side of grill by inserting the shelf hooks into the slots on the side of the grill and pushing down on the shelf assembly until level with grill. (See Fig. 13)
2. Lock the shelf in place by inserting (2) self tapping screws into shelf. (See Fig. 14)

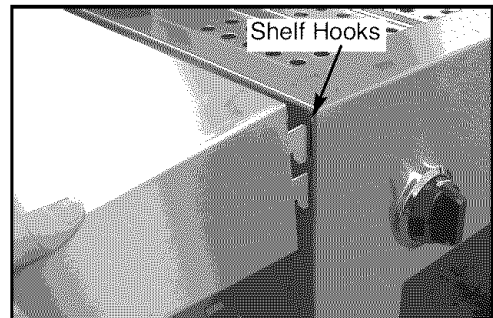

Fig. 13

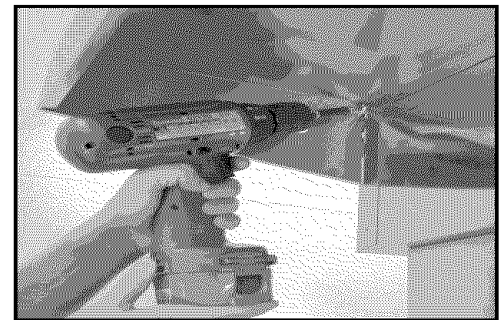

Fig. 14

Interior parts installation

1. Check to make sure the bottom Flavor Grids are correctly installed in the cutouts and around the igniters, as they may have shifted during shipment. (See Fig. 15)
2. Insert the second row of Flavor Grids into cutouts with triangle ridges facing up. (See Fig. 16)
3. Install cooking grates on the ledges provided on the grill to create your cooking surface. (placing the one with a thumb hole in the middle) (See. Fig. 17)
4. Place warming shelf on support brackets by setting it flat across brackets allowing the two holes to line up with the stops on each bracket. (See Fig. 18)

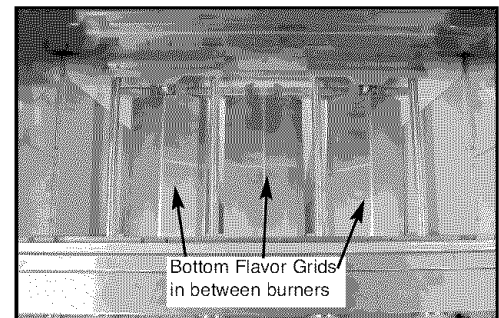

Fig. 15

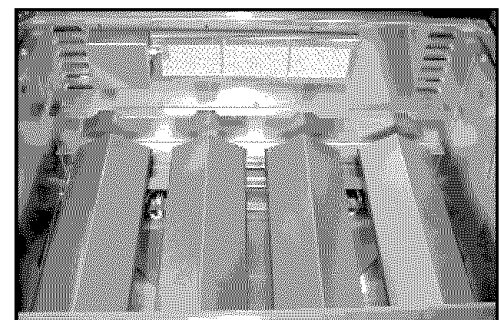

Fig. 16

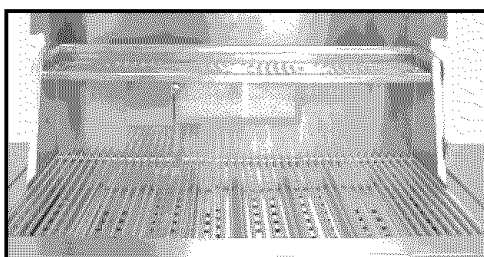

Fig. 18



Fig. 17



Side Burner Assembly

1. Attach the Side Burner to the grill by inserting the shelf hooks into the slots on the side of the grill and pushing down on the shelf assembly until level with the grill (See Fig. 19)
2. Lock the Side Burner in place by re-inserting (1) hex head screw in the front edge of side burner. (See Fig. 20)

Note: A power screwdriver extension is needed to insert screw.

3. Attach the Flex Line coming from the side of the grill to the fitting on the bottom of the Side Burner. (See Fig. 21)
4. Attach the ignitor wire coming out from the side of the grill to the side burner ignitor point. (See Fig. 22)

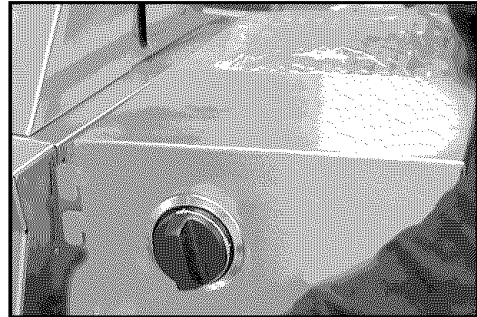

Fig. 19



Fig. 20

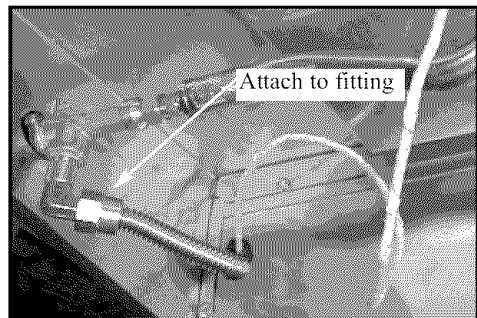

Fig. 21

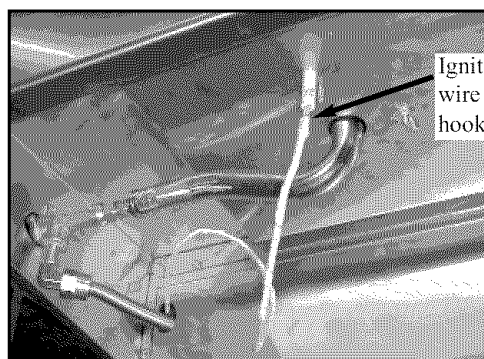
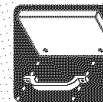

Fig. 22

Side Burner Assembly



SIDE BURNER PARTS ASSEMBLY

Install grate over burner (See Fig. 23)

LEAK TESTING

Make sure all burners are turned to “OFF”.
Turn on the gas at the cylinder (LP models) or main valve (Natural models). DO NOT turn on the side burner. Perform a leak test at all connections and fittings by spraying a 50/50 solution of water and soap. If any bubbles appear, correct the leak before attempting to light the grill or side burner.

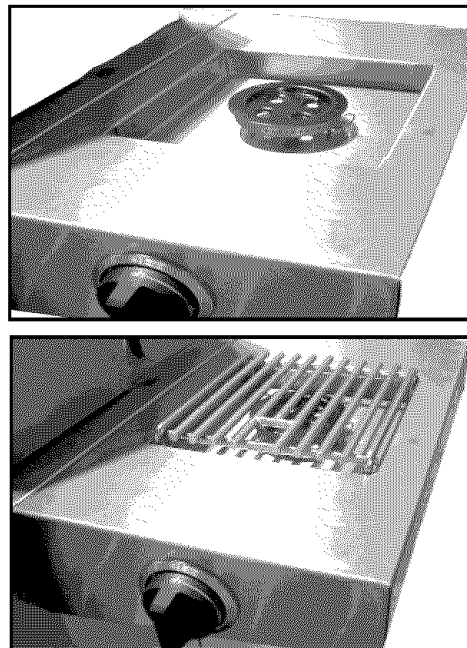

Fig. 23



Built-In Instructions

The Frigidaire Grill can be installed as a built-in Grill. If installed as a built-in Grill, the Grill surround **must be constructed of Non-combustible material.**

Planning and Design

Start by identifying the number and size of components you want to include: Grill, side burner, access doors for storage or other items you may wish to furnish such as: refrigerator, sink, warming drawer. Countertops must be constructed with non-combustible, outdoor-safe materials. Consider outdoor lighting to illuminate after-dark Grilling. For assistance in designing and building your outdoor cooking center, contact a landscape architect or general contractor. Review the drawings on the following pages to determine the exact dimensions and items needed for a built-in Grill. Keep in mind that the gas line hook-up is on the right hand side for the main Grill head. The structure, Grill and support items must be kept level throughout the installation to ensure proper operation.

Location

Take into account convenience and visual impact as well as traffic flow, wind exposure, and the site's structural suitability. The Grill should never be placed in an enclosed area without an approved ventilation system, or beneath a combustible overhang. Because the Grill exhausts to the rear, it should never be located in front of a window or less than 12" from hard-to-clean surfaces. We recommend keeping your gas supply lines as short as possible for best performance. To ensure a perfect fit, we strongly recommend that you have all components on hand prior to final construction.

Clearance to Non-Combustible Construction

For your safety a minimum of 3" clearance from the back of the Grill to non-combustible construction is required. You should allow at least 6" side clearance to non-combustible construction. The Frigidaire Grill can be placed directly adjacent to non-combustible construction below the cooking surface.

Outboard Ignitor Plate Installation (26" model only)

The electronic ignitor requires a standard size electrical box, (available at a local hardware store), with a minimum depth of 2.5" to be mounted in the structure. It should be placed on the left front or left side of the built-in island, with the center of the ignitor button no more than 3"-5" from the Grill. The ignitor plate, sold separately, fits over the standard electrical box once mounted in the structure. (See drawing on following page). The ground wire for the ignitor needs to be grounded to a metal structure in order for the ignitor to work.

Utilities

For natural gas Grills, consult your local gas utility company for hook-up requirements. All gas connections should be made by a plumber or a gas supply company. For natural gas installation, the supply line must be at least 1/2" diameter. The rotisserie requires a 110/120 volt electric supply and GFI receptacle. (6.5 amp min.) If your plan includes a sink, arrange for your plumber to run a water line to the site.

Built-In Instructions



Side cutout is needed on left side to feed ignitor wire to the ignitor plate (26" model only)
(Size: 10" high x 5" long, set 1" back from front edge)

Note: Make sure to use a non-combustible base and sides for the structure

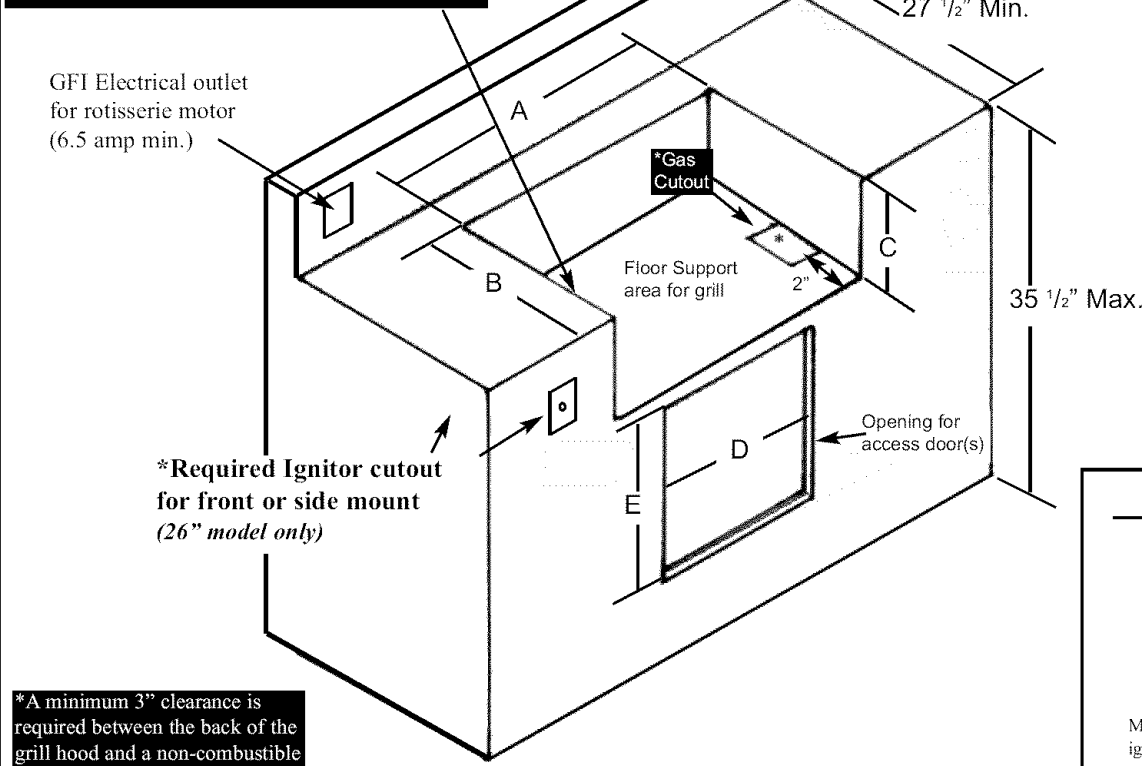

*Required Ignitor cutout for front or side mount (26" model only)

*A minimum 3" clearance is required between the back of the grill hood and a non-combustible surface.

IGNITOR PLATE INSTALLATION

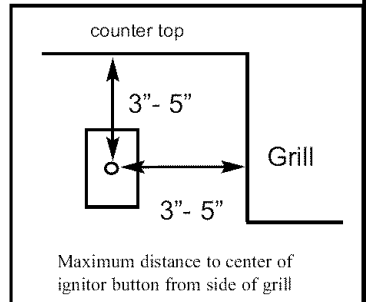

Built-in dimensions **without** using a Trim Kit

Built-in dimensions using a Trim Kit

	26" Grill	30" Grill	38" Grill	Single Access Door	Dual Access Door
A	26 1/8"	30 1/8"	38 1/8"	N/A	N/A
B	19 1/2"	21 1/8"	21 1/8"	N/A	N/A
C	8 5/8"	10 15/16"	10 15/16"	N/A	N/A
D	N/A	N/A	N/A	18 1/4"	36 1/8"
E	N/A	N/A	N/A	18 1/2"	18 1/2"

	26" Grill	30" Grill	38" Grill	Single Access Door	Dual Access Door
A	26 1/2"	30 1/2"	38 1/2"	N/A	N/A
B	19 3/4"	21 1/2"	21 1/2"	N/A	N/A
C	8 5/8"	10 15/16"	10 15/16"	N/A	N/A
D	N/A	N/A	N/A	18 1/4"	36 1/8"
E	N/A	N/A	N/A	18 1/2"	18 1/2"

Additional Requirements:

- *Gas connection cut out in floor support needs to be 4" wide x 9" long, set 2" back from front edge.
- *Ignitor cutout is equal to a standard electrical outlet with a minimum depth of 2 1/2".
- *If using a backsplash apron or rear wall, locate electrical service on the left hand side for rotisserie motor connection.
- *A minimum clearance of 12" from the back must be maintained between the grill and any combustible construction such as wood siding of a residence, 3" minimum for non-combustible construction.



Gas Requirements

General Information

Verify the type of gas supply to be used, either Natural Gas (NG) or Liquid Propane (L.P.), and make sure the marking plate (located on the back of the unit) agrees with that of the supply.

Note: Never attach an unregulated gas line to the appliance.

For Natural Gas installations, an installer must supply a gas shutoff valve that is easily accessible to the grill. All installer supplied parts must conform to local codes, or in the absence of local codes, with the National Electrical Code, ANSI/NFPA 70-1990, and the National Fuel Gas Code, ANSI Z223.1-1998.

All pipe sealants must be an approved type and resistant to the actions of L.P. gases. Never use pipe sealant on flare fittings. All gas connections should be made by a competent technician and in accordance with local codes and ordinances. In the absence of local codes, the installation must comply with the National Fuel Gas Code, ANSI Z223.1-1998. Gas conversions kits are available from the factory. When ordering gas conversion kits have the model number, and the type of gas (natural or L.P.) from your grill.

This Grill and its individual shut off valve must be disconnected from the gas supply piping system during any pressure testing of that system at test pressures in excess of 1/2 PSIG (3.5 kPa.).

This Grill must be isolated from the gas supply piping system by closing its individual manual shut-off valve during any pressure testing of the gas supply piping system at test pressures equal to or less than 1/2 PSIG (3.5 kPa.).

The installation of this Grill must conform with local codes, or in the absence of local codes , with National Fuel Code, ANSI Z223.1a-1998.

Installation in Canada must be in accordance with the Standard Can1-b149.1 and or .2 (installation code for gas burning appliances and equipment) and local codes.

Natural Gas Installation

The gas inlet supply pressure should be between 5" and 14" Water Column,(w.c.) A step down regulator is required if the line pressure is in excess of 14" w.c. Inlet pressure must not exceed 14" water column (1/2 PSIG)

Check your local gas utility company or with local codes for instructions on installing gas supply lines. Be sure to check on type and size of run, and how deep to bury the line. If the gas supply line is too small, the grill will not operate correctly.

Any joint sealant used must be an approved type and be resistant to the actions of L.P. gases.

Attach the natural gas regulator (supplied with your grill) to the brass fitting coming out the bottom, backside of the grill (be sure the arrow on the regulator is pointing up towards the grill). Attach your gas line to the 3/8" flare fitting coming out of the natural gas regulator at the back of the grill.

Place the installer supplied shut-off valve in an accessible location to enable the gas supply to be cut off to the unit.

Gas Requirements

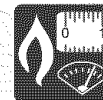

L.P. Gas Installation

Frigidaire Gas Grills that are set to operate with L.P. gas come with a high capacity hose and regulator assembly. **(Note: Only use the pressure regulator and hose assembly supplied with the grill or a replacement pressure regulator and hose assemblies specified by Frigidaire).** This assembly is designed to connect directly to a standard 20 lb. L.P. cylinder.

Attach the gas hose assembly to the brass 3/8 flared fitting using an adjustable wrench on the under side of the grill. Tighten securely and attach other end to the propane tank. (sold separately) (See Fig. 24)

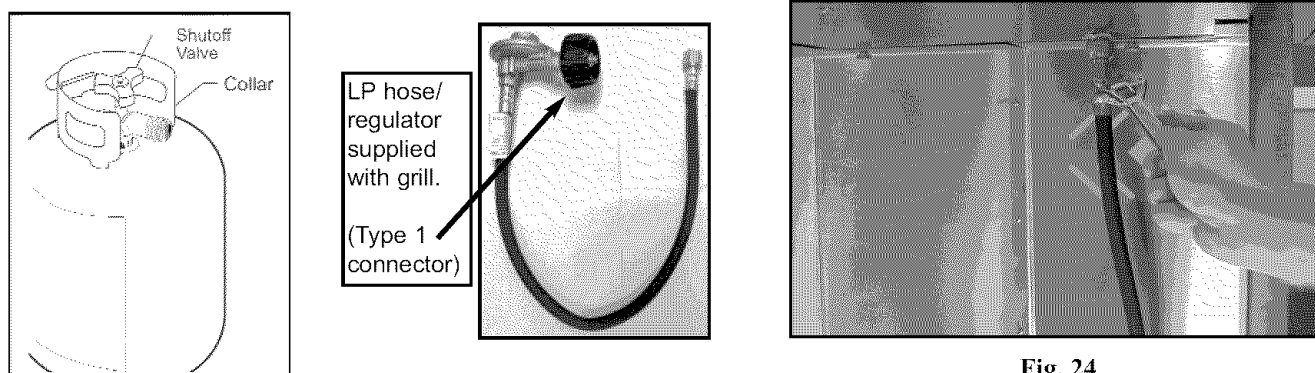

Fig. 24

L.P. Tank Information

Never use a dented or rusted L.P. tank or cylinder with a damaged valve.

The L.P. cylinder must be provided with a shut-off valve terminating in an L.P. gas supply cylinder outlet specified, as applicable, for connection No. 510 in the standard for compressed gas cylinder valve outlet and inlet connection ANSI/CGA-V-1. Cylinders must not be stored in a building, garage, or any other enclosed area. (The L.P. cylinder must have an overfill protection device, OPD, on it.)

The L.P. Gas supply cylinder must be constructed and marked in accordance with the specifications for L.P. gas cylinders of the U.S. Department of Transportation (DOT) or the National Standard of Canada, CAN/CAS-B339, "Cylinders, Spheres and Tubes for the Transportation of Dangerous Goods."

- When not in use, gas supply cylinder valve is to be in the "OFF" position.
- The tank supply system must be arranged for vapor withdrawal. (LP Tank must be kept in an upright position.)
- The regulator and hose assembly must be inspected before each use of the grill. If there is excessive abrasion or wear or if the hose is cut, it must be replaced prior to the grill being used again.
- Cylinders must be stored outdoors out of the reach of children and must not be stored in a building, garage or any other enclosed area.
- Never fill the cylinder beyond 80% full
- Do not store a spare LP-gas cylinder under or near this appliance



Leak Testing

General Information

Although all gas connections on the grill are leaked tested at the factory prior to shipment, a complete gas tightness check must be performed at the installation site due to possible mishandling in shipment, or excessive pressure unknowingly being applied to the unit. Periodically check the whole system for leaks, or immediately check if the smell of gas is detected.

Before Testing

Do Not smoke while leak testing. Extinguish all open flames. Never leak test with an open flame.

Mix a solution of equal parts mild detergent or liquid soap and water.

Testing

1. Turn off the burner control knobs.
2. Turn the top knob of the fuel supply cylinder counterclockwise (right to left) one rotation to open.
3. Apply the soap solution to connections of the fuel supply assembly. If no soap bubbles appear, the grill is ok to use. If bubbles form at the connections, a leak is detected. (If a leak is detected, immediately turn off the gas supply, tighten any leaking fittings, turn gas on, and recheck).
4. Turn off the knob on the fuel supply cylinder.
5. Turn on the burner control knobs for a moment to release the pressure in the hose, then turn the control knobs back off.
6. Wash off soapy solution with cold water and towel dry.

Note: If you cannot stop a gas leak turn off the gas supply and call your local gas utility, or the dealer you purchased the appliance from. If necessary, replace the faulty part with the manufacturers recommended replacement part.

Check all gas supply fittings before each use and each time the gas supply cylinder is connected to the regulator. Have a Qualified Service Technician leak test the grill any time a part of the gas system is replaced. Also have a Qualified Service Technician perform a leak test at least once a year whether or not the L.P. gas supply cylinder has been disconnected.

Using the Grill



Grill Location

Do not use the grill in garages, breezeway, sheds or any enclosed area. Never operate the grill in enclosed areas as this could lead to a carbon monoxide buildup, which could result in injury or death. Place the grill on a level surface. Avoid moving the grill while it is operation.

Note: The grill will operate best if it is not facing directly into the wind.

Clearance to combustible construction - A minimum of 12” from the sides and back must be maintained from the gas grill above and below the cooking surface to adjacent vertical combustible construction.

Clearance to non-combustible construction - A minimum of 3” clearance from the back of the grill to non-combustible construction is required for the lid to fully open.

Storage of an outdoor gas cooking appliance indoor is permissible only if the cylinder is disconnected and removed from the appliance.

General Rules

Do Not leave the grill unattended while cooking!

1. Make sure the grill has been leak tested and is properly located.
2. Light the grill burners using the instructions provided in this manual.
3. Turn the control knobs to “High” and preheat the grill for 10 minutes before cooking.
4. Adjust heat settings to meet your cooking needs for desired results.
5. Allow grill to cool down, wipe off any splatters or grease and clean the drip tray as needed.

*Keep any electrical supply cord and the fuel supply hose away from any heated surfaces.

***The location of the burner tube with respect to the the orifice is vital for safe operation. Check to ensure the orifice is inside of the burner tube before using your grill. This is Very Important.**



Lighting the Grill

Before Lighting

Warning: Important! Before Lighting...

Check the gas supply line for cuts, wear or abrasion.

Always keep your face and body as far away from the grill as possible when lighting.

Grill Burner Lighting

Lighting the Grill with electronic ignitor

Always open the lid before attempting lighting. Push and turn one of the control knobs counter clockwise to the “HIGH” position and immediately press the electronic ignitor button. You’ll hear a snapping sound. It may be necessary to hold the electronic starter button for about 4 seconds. If the burner does not light in 4 seconds, turn the knob to OFF and wait 5 minutes before trying again. Repeat above steps to light remaining burners. (See Fig. 25)

Match Lighting

If by chance the electronic ignitor does not light the burner, the burner may be lit with a match. Keep your face as far away from the Grill surface as possible and pass a lit, long stem match through the spaces in the Grill rack to the ports of the back crossover burner between the flavor grids. Position the match near the burner ports and push and turn the control knob counter clockwise to the “HIGH” position. (See Fig. 26)

Note: If the grill will not light after several attempts see the Troubleshooting section of this manual. Turn the control knobs to the OFF position when not in use.

Do not attempt to “Light” the grill if the odor of gas is present!!

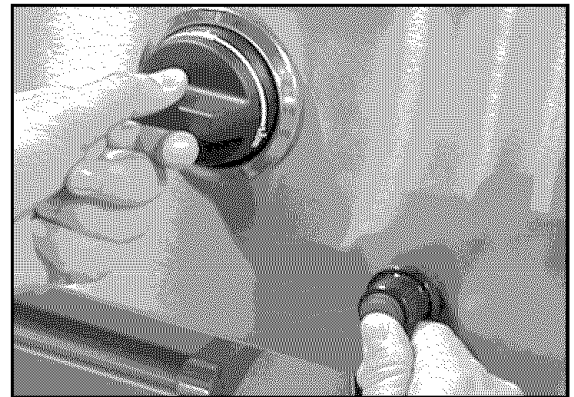

Fig. 25

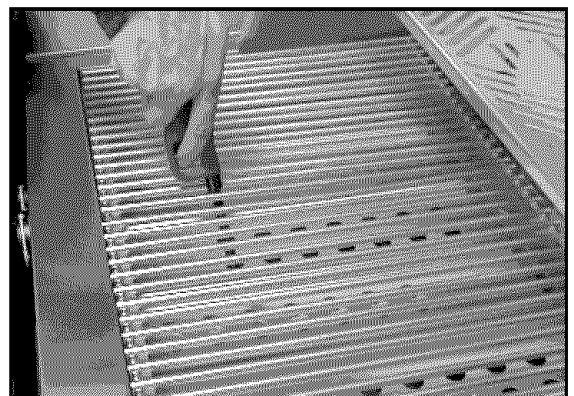

Fig. 26

Using the Rotisserie & Side Burners



(Optional **ROTISSERIE KIT** to use with Back Infrared Burner must be purchased separately)

The grill rotisserie system is designed to cook items from the back using infrared heat. The rotisserie burner is an infrared type which provides intense searing radiant heat. Preferred by chefs over other cooking methods, this intense heat is magnificent for searing in the natural juices and nutrients found in quality cuts of meats.

Once lit, the rotisserie burner will reach cooking temperatures in 1 minute. The orange/red glow will even out in about 5 minutes. The rotisserie motor is equipped with metal gears and is capable of turning up to 20 lbs. of food. The motor is mounted on a bracket on the left side of the grill by sliding the motor over the bracket with the cord facing the back of the grill. Make sure the motor is straight prior to operating.

Warning: Electrical Grounding Instructions

This appliance (rotisserie motor) is equipped with a three-prong (grounding) plug for your protection against shock hazard and should be plugged directly into a properly grounded three-prong receptacle. Do not cut or remove the grounding prong from this plug.

Attaching the Rotisserie (purchased separately)

The motor is mounted on a bracket on the left side of the grill by sliding the motor over the bracket with the cord facing the back of the grill. (For bracket installation see separate instruction sheet)

With the rotisserie motor in place and plugged into an electrical outlet it is now ready to operate. After installing rotis rod handle, slide one of the meat forks onto the rod. (prongs facing away from the handle) Push the rod through the center of the food, then slide the second meat fork onto the rod. (prongs toward the food). Center the food to be cooked on the rod, then push the meat forks firmly together. Tighten the wing nuts. It may also be necessary to wrap food with butcher's string, (never use nylon or plastic string) to secure loose portions.

Once the food is secure, insert the pointed end of the rotis rod into the motor assembly and rest the other end on the support on the right-hand side of the Grill. (If needed remove the cooking grates for more room.). Turn the power switch to the "On" position to start the rotisserie motor.

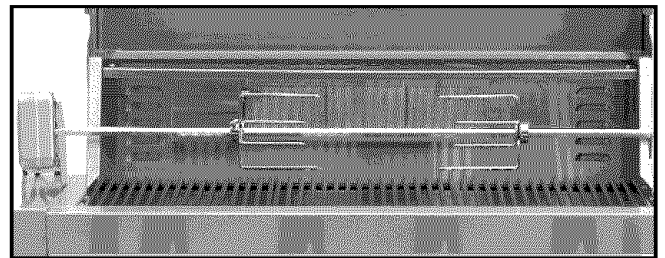

**Note: Remove the rotisserie when not in use.
Remove warming shelf when using rotis.**



Using the Rotisserie & Side Burners

Rotisserie Lighting

Open the lid. Push and turn the control knob counter clockwise to the “HIGH” position. **Wait 5 seconds.** Then press and hold the electronic ignitor button. You’ll hear a snapping sound. If the burner does not light in 4 seconds, turn the control knob to OFF and wait 5 minutes before trying again. Once lit, turn the control knob to the desired setting. (See Fig. 27)

(If the ignitor does not function, the burner can be lit by holding a lit match to the burner while the control knob is turned counter clockwise to “HIGH”.)
(See Fig. 28)

NOTE: After the first use the stainless steel around the burner will darken. This is a normal occurrence of the non-rusting, type 304 stainless steel used on the grill. The infrared panel will also darken after initial use. This is a normal occurrence.

Note: Do Not operate the main burners and infrared back burner at the same time.

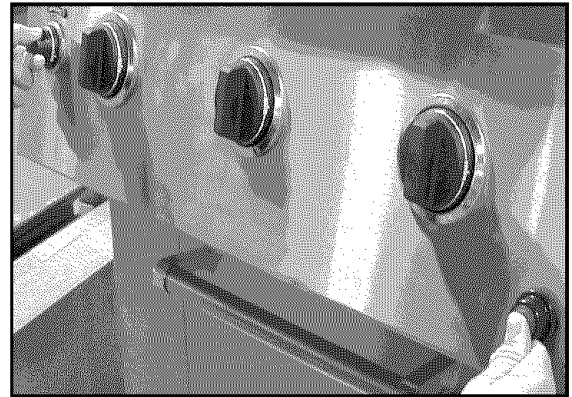

Fig. 27

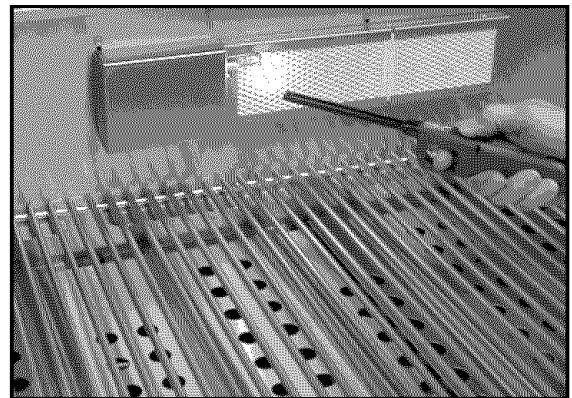

Fig. 28

Side Burner Lighting

Push and turn the control knob to the “HIGH” position and immediately press and hold the electronic ignitor button. You’ll hear a snapping sound. It may be necessary to hold the electronic starter button for about 4 seconds. If the burner does not light in 4 seconds, turn the knob to the “OFF” position and wait 5 minutes before trying again. Repeat above steps to light remaining burners.
(See Fig. 29)

Match Lighting

If by chance the electronic ignitor does not light the burner, the burner may be lit with a match. Keep your face as far away from the burner as possible and place a lit, long stem match through the spaces in the grate to the ports of the burner. Position the match near the burner ports and push and turn the control knob to the “HIGH” position.

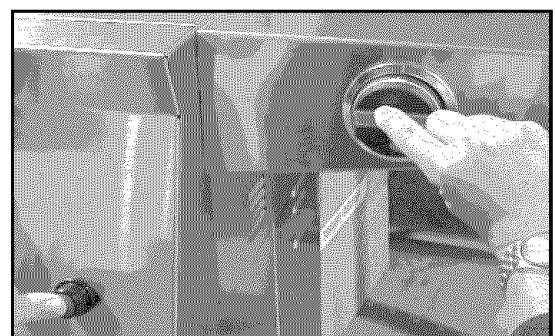

Fig. 29

Care and Maintenance



Drip Tray

The drip tray located below the grill, inside the cart, should be cleaned periodically to prevent heavy buildup of debris.

Note: Allow the drip tray to cool before attempting to clean.

Cooking Grates

The cooking grates can be cleaned immediately after cooking is completed and after turning off the flame. Wear a barbecue mitt and scrub the cooking grates with a damp cloth. If the grill is allowed to cool down, cleaning the grates will be easier if removed from the grill and cleaned with a mild detergent.

Stainless Steel

The grill is made from a non-rusting stainless steel. After initial usage, areas of the grill may discolor from the intense heat given off by the burners, this is normal.

Purchase a mild stainless steel cleaner and rub in the direction of the grain of the metal. Specks of grease can gather on the surface of the stainless steel and bake on to the surface and give a worn appearance. For removal use a non-abrasive oven cleaner in conjunction with a stainless cleaner.

Note: Always scrub in the direction of the grain.

Ignitor Access:

If the ignitor should ever need to be replaced, there is an access door in the bottom of the front panel, below the ignitor.

It is opened by removing the two 1/4" hex head screws that hold it in place. (See Fig A)

To remove Ignitor, unscrew ignitor push button and locking nut from front panel of grill and ignitor will fall down through opening. (See Fig. A)

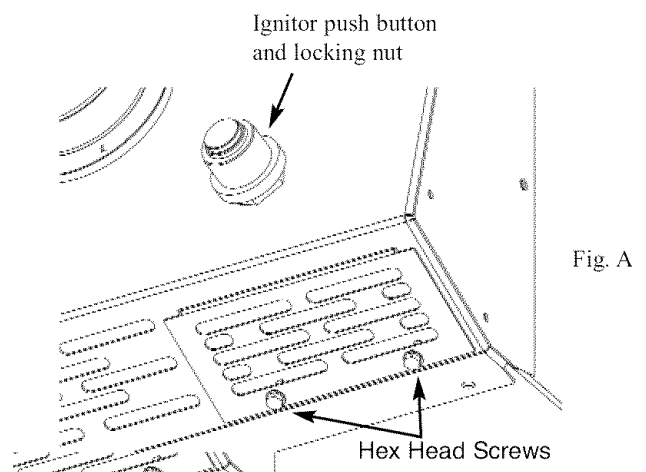

Rear Infrared Burner:

Please light and burn the rear infrared burner at least once a month to ensure there is not a build-up of debris or grease on the burner. This will ensure the ceramic burner will continue to operate as it should.



Trouble Shooting

General Trouble Shooting

You should inspect the burners at least once a year or immediately if any of the following conditions occur:

- The smell of gas in conjunction with the burner flames appearing yellow.
- The Grill does not reach temperature.
- The burners make a popping noise.
- The Grill heats unevenly.

Before calling customer service

If the Grill does not function properly, use the following checklist.

<u>Problem</u>	<u>Solution</u>
Grill will not light when the ignitor button is pushed.	<p>After opening tank valve, be sure one of the Grill control knobs is on high for at least 4 seconds while pushing ignitor button.</p> <p>Check tank fuel level.</p> <p>Check for loose wire connections.</p> <p>Remove the cooking grates and flavor grids. Push ignitor button, and check for spark on tip of electrode.</p> <p>Check to see if debris is blocking the electrode sparks.</p> <p>Check battery/replace battery.</p> <p>Attempt to match light the burner.</p> <p>If using L.P. gas, disconnect gas line at tank, then reconnect.</p>
Low heat with knob in "High" position.	<p>Check for proper gas supply and pressure.</p> <p>If using L.P. gas check for low fuel level.</p> <p>If using L.P. gas check for kinks in supply line.</p> <p>If only one burner appears low, clear burner ports of any obstructions.</p> <p>Pre-heat Grill for a full 10 minutes.</p> <p>If using L.P. gas, disconnect gas line at tank, then reconnect.</p>

Trouble Shooting



<u>Problem</u>	<u>Solution</u>
Flame is erratic	<p>Check gas connection.</p> <p>Fuel level may be low.</p> <p>Grill may be in need of cleaning.</p>
Flare-Ups	<p>Check flavor grids and cooking grates for excess build-up.</p> <p>Ensure Grill is not placed directly in path of wind.</p> <p>Be sure the drip tray is clean. (do not use aluminum foil in drip tray)</p>
Burner flame is yellow or orange, in conjunction with the odor of gas.	<p>Check the burner inlet for obstructions.</p> <p>Grill may be in a windy area. Move to a less windy area if possible.</p>
Cart door does not align properly with cart	<p>Loosen the four bolts that attach grill head to cart. Slide grill head either to the left or right until door is aligned properly. Retighten the bolts.</p>

Spider and Insect Warning

Spider and insects can nest in the burners of this or any other Grill and cause the gas to flow from the front of the burner. This is very dangerous condition which can cause a fire to occur behind the valve panel, thereby damaging the Grill and making it unsafe to operate. We recommend you check at least once a year to be safe.



Warranty

LIMITED LIFETIME WARRANTY

Frigidaire Grills have a Lifetime Warranty on all stainless steel panels, 15 years on stainless burners and a 5 year warranty on all other parts.

IMPORTANT: We recommend you return the warranty registration card so that you can be contacted with any questions of safety arise that could affect you. The return of the warranty registration card is not a condition for warranty coverage.

LIMITED WARRANTY

If the Frigidaire Grill does not operate properly, first thoroughly carry out the instructions provided with the unit to ensure that the appliance is installed correctly and check the Troubleshooting section.

- The warranty is nontransferable.
- The warranty is for replacement of defective parts only. Frigidaire will not be responsible for damage resulting from accident, alteration, misuse, abuse, hostile environments, improper installation or installation not in accordance with local codes.
- This limited warranty does not cover corrosion or discoloring due to lack of maintenance, misuse, hostile environments, alterations, accidents or abuse or neglect.
- This limited warranty does not cover any scratches, dents, corrosion or discoloring by heat, abrasive and chemical cleaners nor any components used in the installation of the appliance.

If you have other questions, please contact Customer Service Hotline
(800) 320-0859

Because of continuing product improvement these specifications are subject to change without notice.

FD38IMD

1/2004